

Standard Five-Axis Servo Driven Robot

ST5-900-1600DT-S2



Refer carefully to this manual before operation.

■ Coding Principle

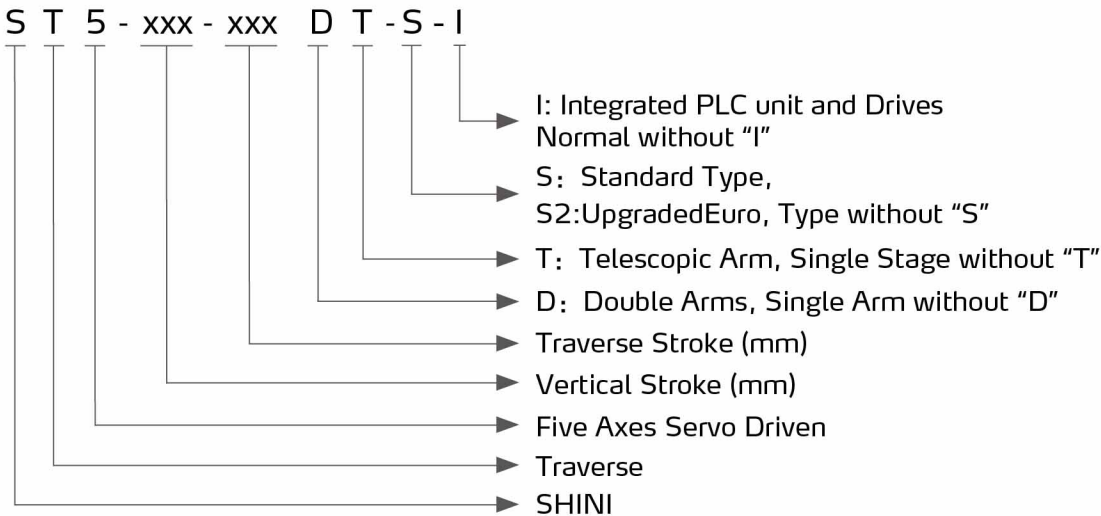

Home Page

■ Features

● Precision

All linear movements are driven by heavy duty servo motors with cooperation of precise linear guide rails and high power V belts; fast, silent, and precise. Wrist mechanism employs pneumatic driven rack and pinion system, which accomplishes smooth, stabled and precise flipping motion. Vertical arm with telescopic design efficiently minimizes the cycle time and height of the robot.

● Safety

The travel limit of the X, Y, and Z-axis are with anti-collision devices. It can effectively prevent operation out of control. Complete dual protection function with the soft and hard limit. Ensure the safe operation of injection molding machine and travel robot. The design of I / O short-circuits protection can effectively prevent the circuit board from damage due to an electrical short circuit.

● Intelligence

7.0 inch high definition TFT touch screen. The USB can be used to upgrade the manual controller and mainboard, download program data, and the open program teaching, 8BG memory, and independent dual 16-bit IO expansion board can expand up to 4 IO boards. The hardware used multi-layer PCB and multi-rank high precision electrical modular, strong anti-interference ability. Hardware protect function, each signal output with intelligent detection, avoid short-circuit, over-load and high temperature. Base on the VARAN BUS technology, the system can be extended, strong adaptability and flexibility. Teach modules with stacking and matrix locate functions, support conditional judgment, loop control, signal waiting and others logic instructions.

● User Friendly

Multi-languages system and reserved auxiliary equipment slots able to support our global clients' need.

■ Application

The ST5-S series robot is designed for rapid and precise removal of products from injection molding machine, and place them at desired locations. Standard and telescopic arm(s) are selectable to cooperate with 2-plate mold or hot runner system. Capable of arranging, stacking, quality checking and in mold placement. Suitable for injection molding machine under 850T clamp force.

ST5-S Series

Outline Drawings

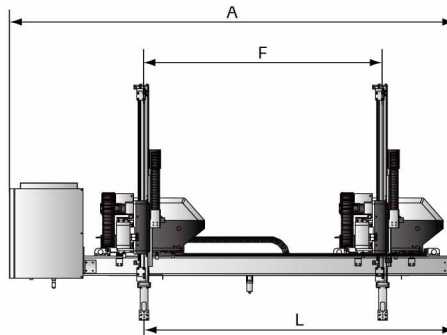
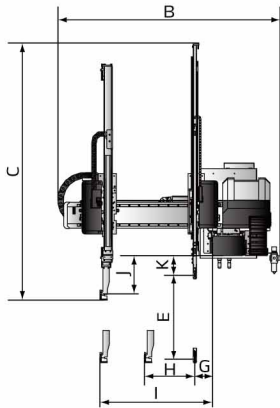

5-axis servo with single kick-stroke beam

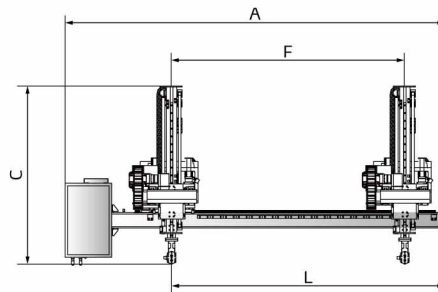
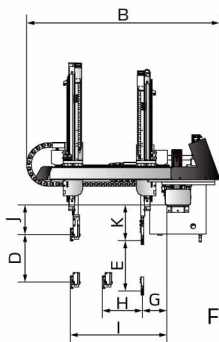

Five axes servo small telescopic (bracket type) robot arm

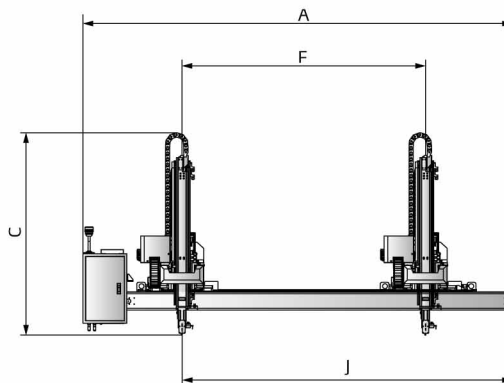
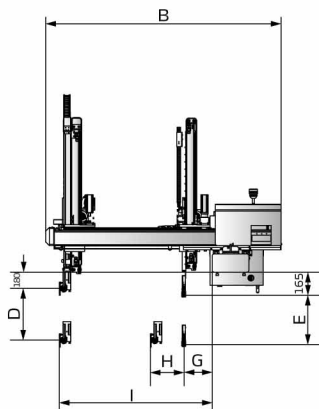

Five Axes Servo Telescopic (Movable-beam type)



■ Specifications

Model(ST5)		900-1600DT-S2	1100-1800DT-S2	1300-2000DT-S
Robot Type		Single kick stroke beam	Single kick stroke beam	Single kick stroke beam
IMM (ton)		220-260	320-400	450-650
Traverse Stroke (mm)		1600	1800	2000
Crosswise Stroke (mm)	Main Arm	700	850	850
	Sub Arm	700	850	850
Vertical stroke (mm)	Main Arm	1000	1200	1300
	Sub Arm	1000	1200	1300
Max Load (with tool) (kg)		5	6	6
Min Pick-out Time (sec)		1.4	1.4	1.8
Min Cycle Time (sec)		5.5	6.3	6.8
Air Pressure (bar)		4~6	4~6	4~6
Max. Air Consumption (NI/cycle) *		4	4	6
Weight (kg)		320	320	360
Dimensions (mm)	A	2640	2880	3080
	B	1800	1900	1900
	C	1350	1450	1450
	D	1000	1200	1200
	E	1000	1000	1200
	F	1600	1800	2000
	G	180	250	250
	H	110	220	220
	I	900	1160	1160
	J	230	200	200
	K	220	200	200
	L	1900	2200	2400

- Notes: 1) "M" stands for middle mold detector. (suitable for three-plate mold.)
 "EM12" stands for EUROMAP 12 communication interface.
 "EM67" stands for EUROMAP 12 communication interface.
 "ABS" at the end of the model code stands for models of high precision.
 "N" stands for non-operation side, operation side without "N"
 2) Power supply: 1Φ, 200~240V, 50/60Hz.
 3) " * " Max. air consumption for vacuum device 60NI/min.
 4) () means option.

ST5-S Series

Specifications

Model(Medium telescopic)		ST5-1500-2200DT-S
Robot type		Medium size robot with frame type beam
IMM (ton)		650 ~ 850
Traverse Stroke (mm)		2200
Crosswise Stroke (mm)	Main Arm	850
	Sub Arm	850
Vertical stroke (mm)	Main Arm	1500
	Sub Arm	1550
Max Load (with tool) (kg)		12
Min Pick-out Time (sec)		3.5
Min Cycle Time (sec)		9.5
Air Pressure (bar)		4 ~ 6
Max. Air Consumption (NI/cycle) *		6
Integrated PLC unit and Drives		-
Weight (kg)		930
Dimensions (mm)	A	3850
	B	2140
	C	1610
	D (max)	1500
	E (max)	1550
	F (max)	2200
	G (min)	245
	H (min)	170
	I (max)	1220
	J	2900

- Notes: 1) "M" stands for middle mold detector. (suitable for three-plate mold.)
 "EM12" stands for EUROMAP 12 communication interface.
 "EM67" stands for EUROMAP 12 communication interface.
 "ABS" at the end of the model code stands for models of high precision.
 "N" stands for non-operation side, operation side without "N"
- 2) Power supply: 1Φ, 200~240V, 50/60Hz.
 3) " * " Max. air consumption for vacuum device 60NI/min.
 4) () means option.
 5) "●" means: option, and add "I" at the model code, and "-" means: unavailable

Shini Group

Addr: No. 23, Minhe St., Shulin Dist.,
New Taipei, Taiwan

Tel: +886 2 2680 9119

Fax: +886 2 2680 9229

Email: shini@shini.com

Factories:

- Taiwan
- Dongguan
- Pinghu
- Ningbo
- Chongqing
- Pune

2024-10-15-04 Copyrights Reserved.

www.shini.com