

Material storage tank & Suction box



MST Series

■ Coding Principle

MST-XXX (EB/S/C)

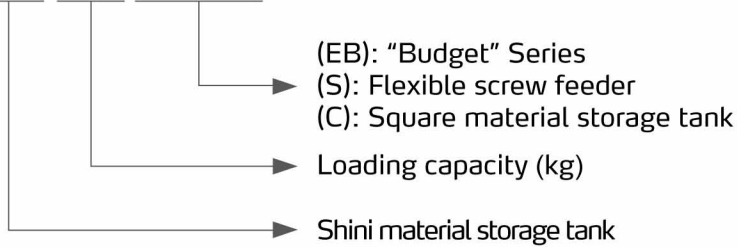

■ Features

- Made up of SUS201, durable service.
- Material storage tank MST is round shaped and material storage tank MST-S/C is square shaped;
- MST-S, only applies to SSC;
- The top cap of MST-50 is connected with the tank on one side, open it to add materials. The top cap of MST-100~500 consists of two parts (half fixed and half can be opened), convenient for adding materials.
- MST&MST-C is equipped with Euro-material suction box (single pipe 1.5"), convenient for material conveying.
- MST-EB is equipped with four 3" castors, two are movable and another two are with brakes for easy movement.



MST



MST-C



MST-S



MST-EB

■ Application

Mainly used for material storage, placed beside material room or IMM; Works with granulator to convey regrind material, ensuring instant reuse of recycled material.

MST&MST-C is outfitted with a 1.5" material suction box, with the option of the material suction box in various specs or material shut-off suction box.

■ Options

- All material contacted surfaces of the material storage tank MST are polished, and add "P" at the end of the model code.
- For material storage tank adopts stainless steel SUS304, and add "S304" at the end of the model code.

Outline Drawings

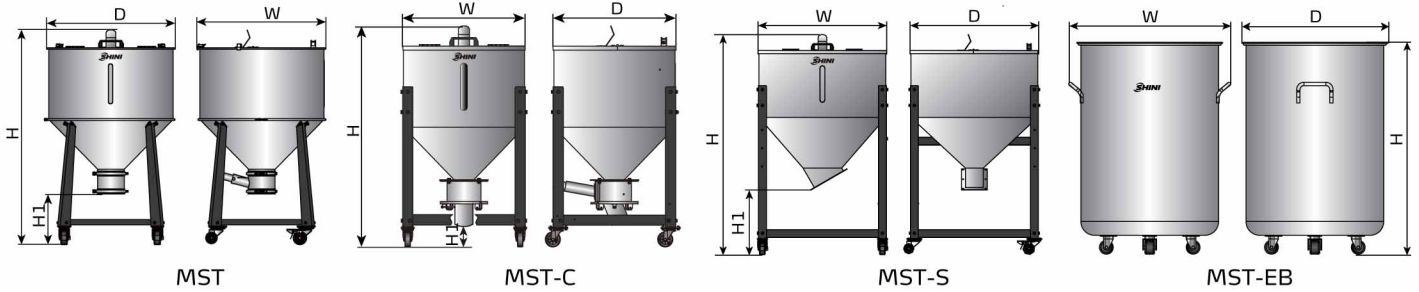

Specifications

Model	Capacity (kg) *	Dimensions (mm) H × H1 × W × D	SBU model	Weight (kg)
MST-50	50	1080×275×585×585	SBU-50	28.5
MST-100	100	1210×290×740×740	SBU-100	32.5
MST-200	200	1330×285×890×890		43.5

Model	Capacity (kg) *	Dimensions (mm) H × H1 × W × D	SBU model	Weight (kg)
MST-50C	50	885×140×520×545	SBU-20	30
MST-100C	100	1095×110×625×655	SBU-160	48
MST-200C	200	1170×105×825×855		62
MST-500C	500	1585×190×1260×1275		105

Model	Capacity (kg) *	Dimensions (mm) H × H1 × W × D	Weight (kg)
MST-100S	100	1290×390×625×625	52
MST-200S	200	1390×410×825×825	66
MST-300S	300	1640×390×950×950	80
MST-500S	500	1730×420×1250×1250	110

Model	Capacity (kg) *	Dimensions (mm) H × W × D	Weight (kg)
MST-100EB	100	770×580×539	12
MST-200EB	200	970×685×639	17

Notes: 1) "*" stands for loading capacity is based on pellet material of 0.65kg/L in bulk density and 3-5mm in diameter.

2) Special models can be customized.

SBU Series

■ Coding Principle

SBU-xxx-xx-x-V-x

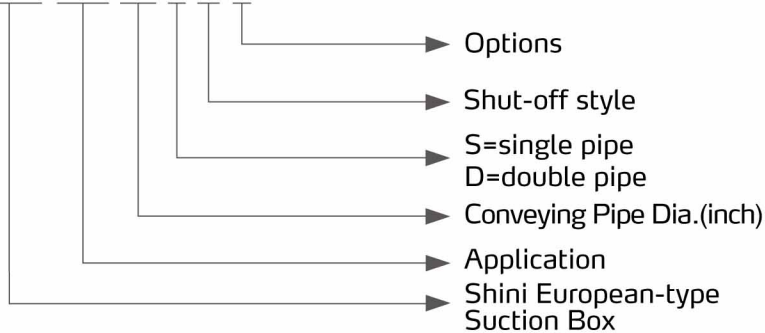

■ Features

- Special internal structure ensures smooth material conveying
- Standard suction box with air-feeding hole, easy to use; shut-off suction box equipped with air feeding pipe to form closed conveying cycle and avoid pipe blockage;
- The suction box SBU-20/160 is made of Aluminum, with integrated design; The suction box SUB-50/100 is made of stainless steel.



SBU-20/160-S

SBU-20/160-D

SBU-160-S-V

SBU-160-63D-V

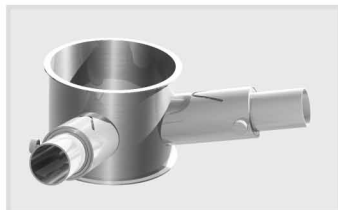

SBU-50/100-D

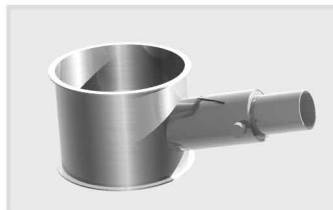

SBU-50/100-S



SBU-50/100-S-V

■ Options

- Stainless steel is optional for SBU-20/160, add "S" at the end of the model code.
- If selecting stainless steel, parts contacting with materials can be polished, add "P" at the end of the model code.

■ Application

The suction box SBU-20/160 is installed at the bottom of drying tank or other storage devices, and the suction box SBU-50/100 is installed at the bottom of material storage tank that can work with negative pressure conveying system to convey materials. Standard suction box is applicable for short distance conveying, while the shut-off suction box, which is equipped with material shutting off function, can prevent material remaining in pipe, moisture regain and pipe blockage during long distance conveying.

Outline Drawings

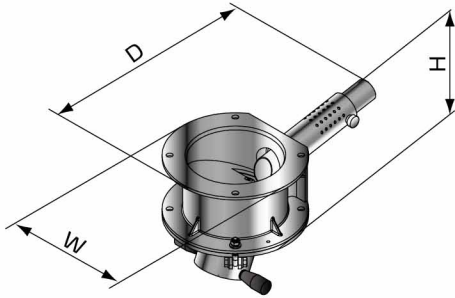

SBU-20/160-S

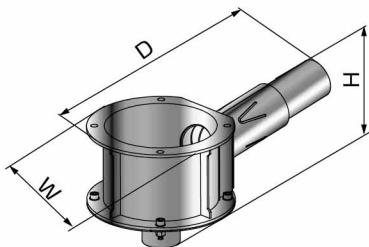

SBU-160-63S

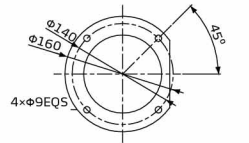

SBU-20

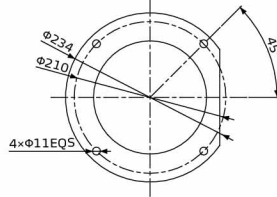

SBU-160

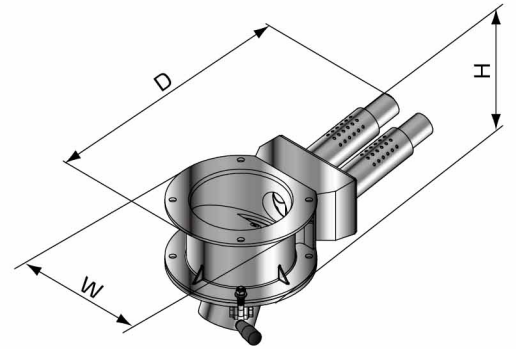

SBU-20/160-D

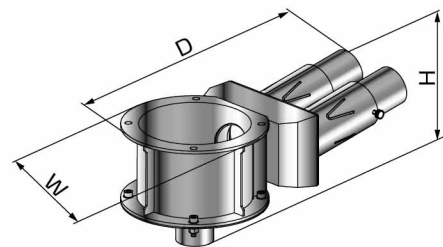

SBU-160-63D

Model	H×W×D(mm)
SBU-20-38S	210×180×390
SBU-20-50S	210×180×390
SBU-160-38S	235×235×435
SBU-160-50S	235×235×450
SBU-160-63S	197×234×468

Model	H×W×D(mm)
SBU-20-38D	200×180×414
SBU-20-50D	200×180×414
SBU-160-38D	230×235×485
SBU-160-50D	230×235×480
SBU-160-63D	197×234×507

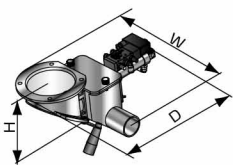

SBU-20-S-V

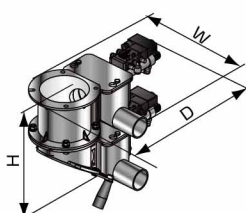

SBU-20-D-V

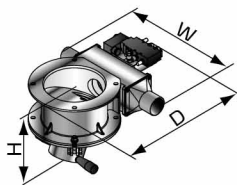

SBU-160-S-V

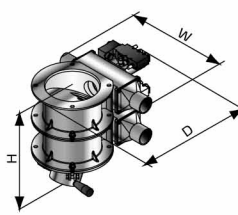

SBU-160-D-V

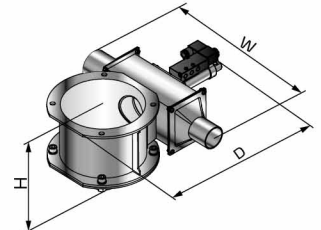

SBU-160-63S-V

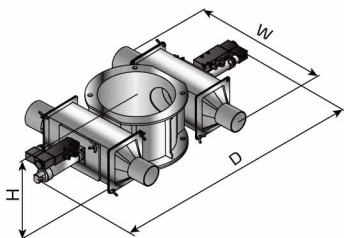

SBU-160-63D-V

Model	H×W×D(mm)
SBU-20-38S-V	182×250×388
SBU-20-50S-V	182×252×388
SBU-160-38S-V	230×330×440
SBU-160-50S-V	230×330×440
SBU-160-63S-V	200×365×473

Model	H×W×D(mm)
SBU-20-38D-V	295×250×390
SBU-20-50D-V	295×250×390
SBU-160-38D-V	347×330×440
SBU-160-50D-V	347×330×440
SBU-160-63D-V	200×365×670

SBU Series

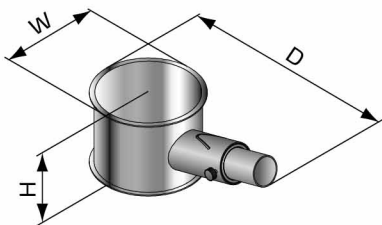

SBU-50/100-S

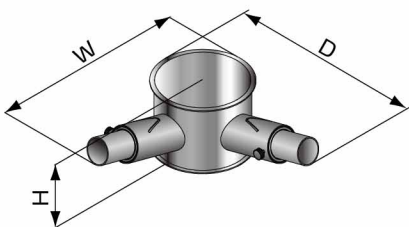

SBU-50/100-D

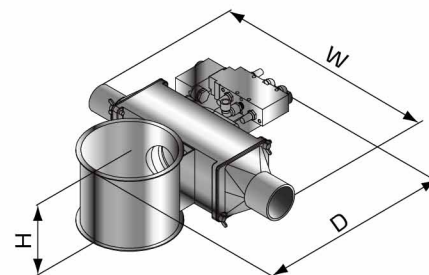

SBU-50/100-S-V

Model	H×W×D (mm)
SBU-50-38S	122×138×315
SBU-50-50S	122×138×315
SBU-100-38S	122×162×340
SBU-100-50S	122×162×340
SBU-100-63S	142×162×350

Model	H×W×D (mm)
SBU-50-38D	122×315×315
SBU-50-50D	122×315×315
SBU-100-38D	122×340×340
SBU-100-50D	122×340×340
SBU-100-63D	142×350×350

Model	H×W×D (mm)
SBU-50-38S-V	125×320×385
SBU-50-50S-V	125×320×385
SBU-100-38S-V	125×320×410
SBU-100-50S-V	125×320×410
SBU-100-63S-V	145×365×425
SBU-100-63D-V	145×365×660

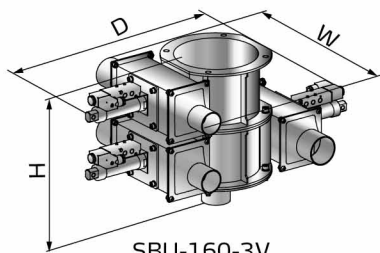

SBU-160-3V

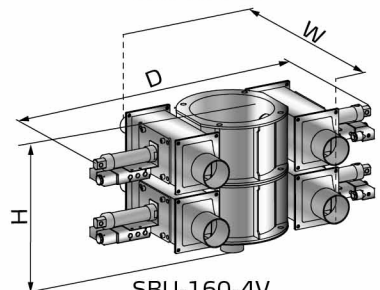

SBU-160-4V

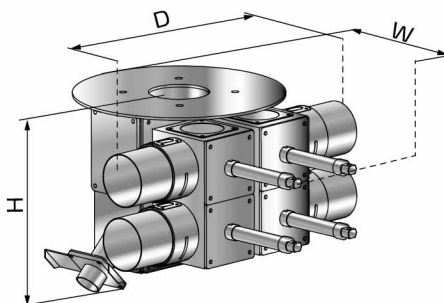

SBU-160-4V-2.5/3/4

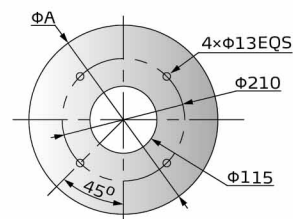

Model	H×W×D (mm)
SBU-160-3V	329×363×663
SBU-160-4V	329×363×663

Model	H×W×D (mm)	ΦA (mm)
SBU-160-4V-2.5	266×472×454	324
SBU-160-4V-3	310×489×458	324
SBU-160-4V-4	345×583×575	400

Shini Group

Addr.: No. 23, Minhe St., Shulin Dist., New Taipei, Taiwan

Tel: +886 2 2680 9119

FAX: +886 2 2680 9229

Email: shini@shini.com