

Heating & Cooling Series
Application Guide

Confidential

Date: April 2013

Version: V3.0 (EN)



Confidential

Contents

1. Preface	6
2. Relative Information	7
2.1 Law of Thermodynamics	7
2.2 Heat Exchanging Formula.....	7
3. Product Classification	9
3.1 Product Category of Industrial Chillers Series.....	9
3.2 Product Category of Mold Temperature Controller.....	9
3.3 Coding Principle	10
3.3.1 Coding Principle for Water Chillers	10
3.3.2 Coding Principle for Central Water Chillers.....	10
3.3.3 Coding Principle of Mold Temperature Controller	10
4. Principle of Refrigeration	11
4.1 Basic Principle of Refrigeration	11
4.2 Application Fields.....	12
4.3 Introduction of Refrigerant.....	13
5. Standard Operation Working Condition for SIC/SICC	16
6. Solution Which SIC is Used in Industrial Refrigerant System	17
7. Factors of Affect Refrigerant Effect for SIC	20
8. Model Selection for SIC	22
8.1 Cooling Capacity Calculation.....	22
8.2 Cycling Water Capacity	24
8.3 Cooling Tower	28
8.4 Standard of Water Quality Used for SIC.....	28
9. Q&A for SIC/SICC	32
10. Application Scope for STM	40
11. Model Selection for STM	40
12. Q&A for STM	42

13. Reference Informations.....	43
13.1 Unit Converter	43
13.2 Optional Pump Parameters for SIC	44
13.3 Specific Heat List of Material	46
13.4 Cooling Parameter Table for STM.....	47
Version.....	48

Confidential

Table Index

Table 4-1: Saturation Temperature and Pressure of R22	13
Table 4-2: Physical Property Comparison of R410A, R407C and R22	15
Table 5-1: Standard Pperation Working Condition for SIC/SICC	16
Table 8-1: Water Quality Standard.....	31
Table 13-1: Temperature Convection.....	43
Table 13-2: Energy Convection	43
Table 13-3: Pressure Convection	43
Table 13-4: Middle Pressure Pump Parameters (50Hz)	44
Table 13-5: Middle Pressure Pump Parameters (60Hz)	44
Table 13-6: High Pressure Pump Parameters (50Hz).....	45
Table 13-7: High Pressure Pump Parameters (60Hz).....	45
Table 13-8: Specific Heat List of Material	46
Table 13-9: Cooling Parameter for STM.....	47

Picture Index

Picture 3-1: Industrial Chiller Categories.....	9
Picture 3-2: Mold Temperature Controller Categories.....	9
Picture 4-1: Circulation of Basic Refrigeration	11
Picture 6-1: Adjusting Cooling Water Capacity by Three Way Valve	17
Picture 6-2: Adjusting Water Outlet Temperature by Three Way Valve	18
Picture 6-3: Adjusting Temperarure by Three Way Valve.....	18
Picture 6-4: High Precision Temperature Control.....	19
Picture 6-5: Use Chemical Liquid and Oil as Medium.....	19
Picture 8-1: SICC-60A Cooling Capacity Graph.....	25
Picture 8-2: SICC-90A Cooling Capacity Graph.....	26
Picture 8-3: SICC-120A Cooling Capacity Graph.....	27
Picture 9-1: Thermo Expansion Valve Sketch.....	32
Picture 9-2: Stepless Adjustment Function Sketch	34
Picture 10-1: Projects Example for STM.....	40

1. Preface

This guide is a model selection and application manual for Heating & Cooling series which includes information of temp. controlling, selection and application of SHINI's Heating & Cooling equipment.

Purpose

In order to assist professionals or customer service staffs to pick out proper products for customers, this guide will help them better comprehend application scope of products and enhance their application proficiency.

Target Group

This guide is applicable for professionals and customer service personnel who face the clients directly and need choose appropriate products as requested.

Related Information

Specific models are subject to "Product Catalogue" during model selection for customers. Please refer to "Model Selection Questionnaire" when the customer's demand is not clear or for other reasons the service is unavailable.

Notice

This guide is used for preliminary model selection of SHINI's Heating & Cooling series products. It is recommended the client contact our customer service personnel before giving an order to ensure correct selection and avoid unwanted loss.

Referential texts and data in this guide do not represent SHINI's viewpoint.

If you need any further information of SHINI products, kindly feel free to contact us:

Dial direct China service hotline: +86 800-999-3222

Log on SHINI Group website: www.shini.com

Send eMail to us: shini@shini.com

2. Relative Information

2.1 Law of Thermodynamics

First Law of Thermodynamics (conservation of energy)

Whichever thermo processes, the total energy of both system and outside of system always is constant when mechanical and thermal energy exchange. It just is:

Input system energy – output system energy = storage energy changing of system

Now assumed that surrounding transfers heat energy (Q) to system, the inner energy state of system is changed from E1 to E2, at the same time system also does work (A) on surrounding, we can say $Q=E2-E1+A$. With the above, we know the heat energy from the surrounding; some make the inner energy of system increase and the other do work on surrounding.

Second Law of Thermodynamics

Heat can not be transferred automatically and without payment from objects with low temperature to the ones with high temperature.

Second law of thermodynamics has meaningful significations, which explains the profound law of natural energy switched direction and describes automatical transferring direction of energy: the mechanical energy that molecules regularly move can be changed completely into the heat energy that molecules move irregularly.

2.2 Heat Exchanging Formula

$$Q = M \times S \times T$$

In which: Q - Needed energy finished heat exchanging, unit: kcal / hr

M - Weight of object for heating exchanging, unit: kg

S - Specific heat of object for heating exchanging, unit: kcal / kg-°C

T – temp. difference of object for heating exchanging, unit: °C

It is possible to get conclusion from the above formula: when objects are exchanging heat, the needed outside energy is relative with weight of objects, specific heat and temperature difference.

Confidential

3. Product Classification

3.1 Product Category of Industrial Chillers Series

At present, Shini industrial chillers could be divided into four series: water-cooled water chillers, air-cooled water chillers, water-cooled central water chillers and air-cooled central water chillers.

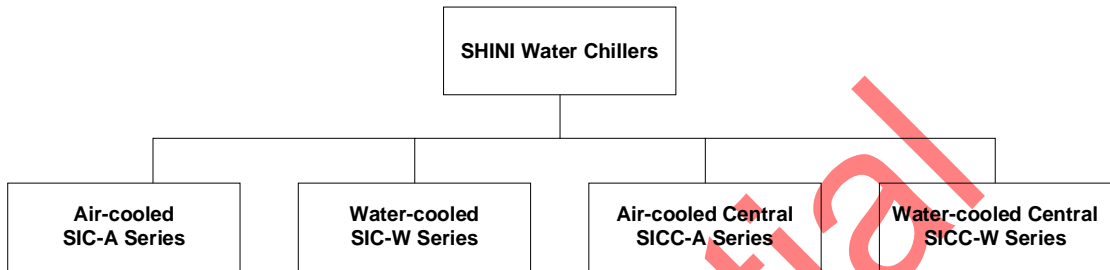

Picture 3-1: Industrial Chiller Categories

3.2 Product Category of Mold Temperature Controller

At present, shini mold temperature controllers could be divided into five series: oil heaters, water heaters, high-temperature water heaters, high-temperature oil heaters and dual purpose water/oil heaters.

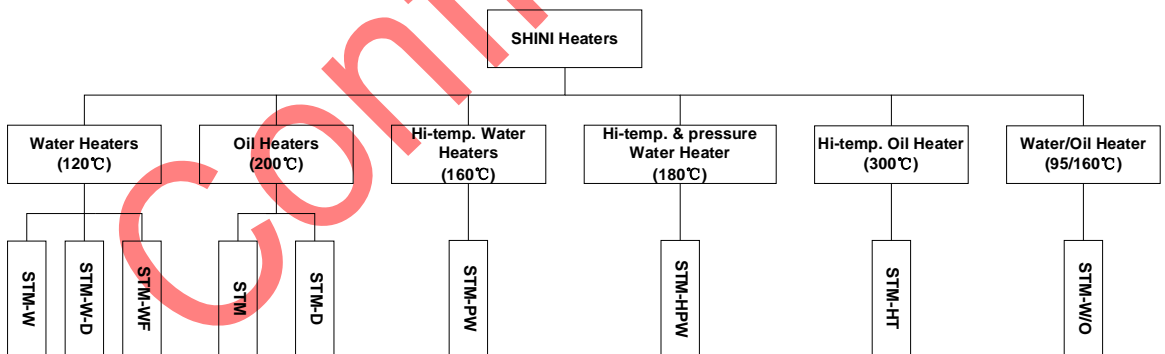

Picture 3-2: Mold Temperature Controller Categories

3.3 Coding Principle

3.3.1 Coding Principle for Water Chillers

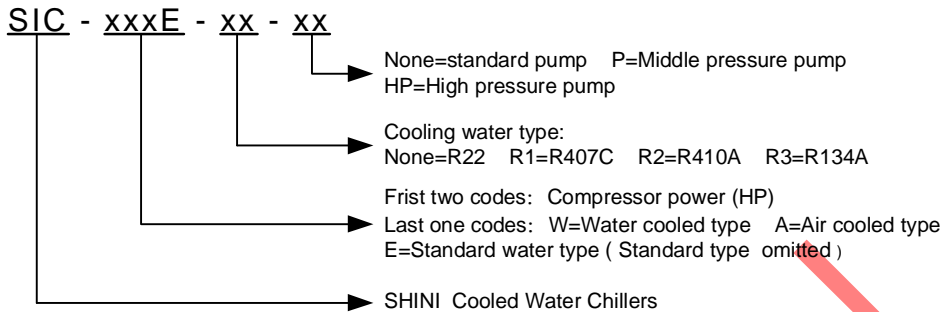

3.3.2 Coding Principle for Central Water Chillers

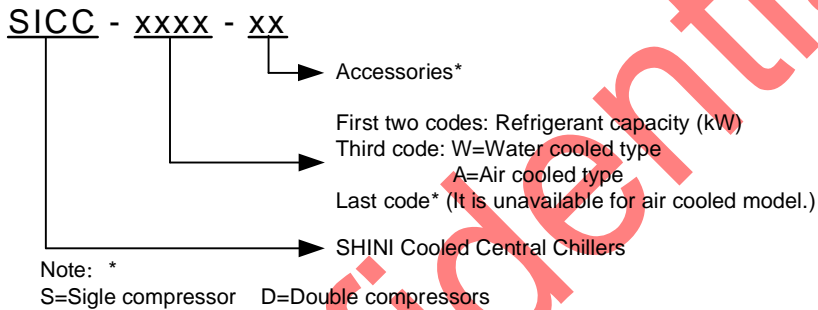

3.3.3 Coding Principle of Mold Temperature Controller

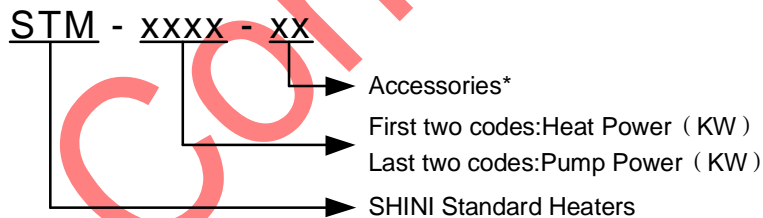

Note: *
 W=Medium is water WE=Standard water type D=Double stages
 PW=Medium is water with high temp. W/O=Medium is water or oil HT=medium is oil with high temp.
 WF=Medium is water with large flow HPW=Medium is water with high temperature and high pressure

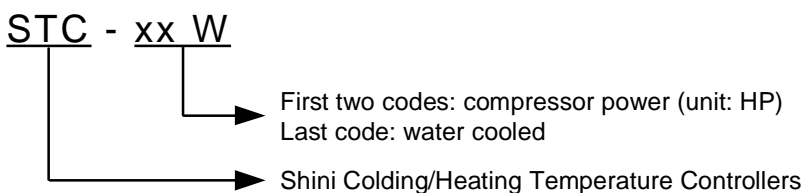

4. Principle of Refrigeration

4.1 Basic Principle of Refrigeration

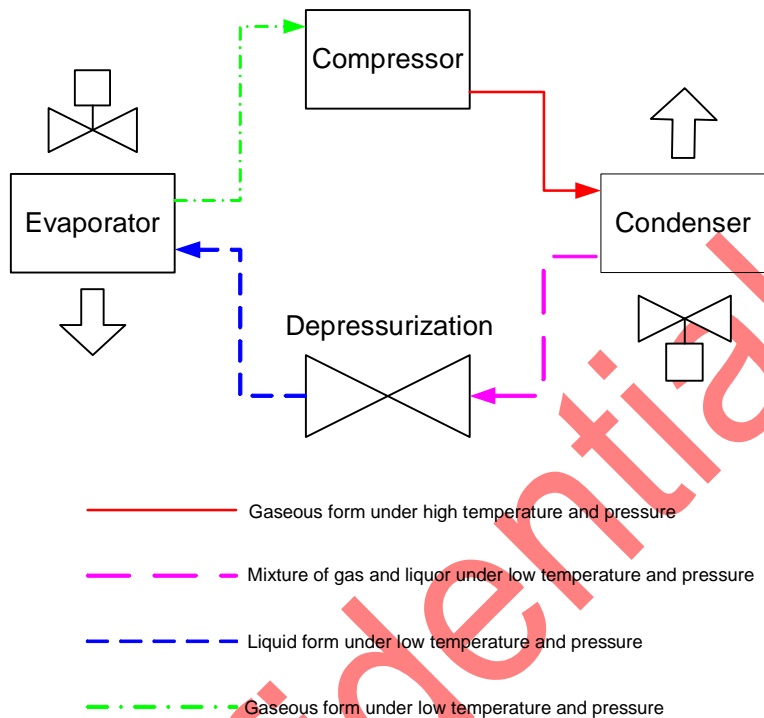

Picture 4-1: Circulation of Basic Refrigeration

Evaporation relates to heat absorption; all liquid must absorb heat when evaporated.

Refrigerant is converted from gaseous state into liquid state in the condenser. Refrigerant pipes enter from the lower part and discharge from the upper which brings down the liquor.

Refrigerant is converted from liquid state into gaseous state in the evaporator. Refrigerant pipes enter from the upper part and discharge from the lower which brings up the air flow.

Refrigerant, which is easily evaporated and condensed, is preferred medium of heat absorption and release. Only a little refrigerant can absorb or release much heat when evaporated or condensed. With low temperature the steam is easy to evaporate to reach the temperature we desired.

Condensation relates to heat release; all steam must release heat when condensed.

Compressor compresses the gaseous refrigerant at low pressure and low temperature into gaseous refrigerant at high pressure and high temperature and maintains this state which is the most important in the whole system. A general power of the compressor accounts for 25%~30% of the cooling capacity of the main refrigerator.

Water pipes will expand when heated and contract when cooled, so the low-temperature pipe lie below and high-temperature pipe lie above to be in favor of water flow.

Chilled water is the circulating water that flows from the main refrigerator to the equipment to be cooled.

Cooling water is the circulating water that flows from cooling water tower to the main refrigerator.

4.2 Application Fields

With the development of industrial modernization and automation, water chiller has played an important role in different production process. It is applied in the field of cooling moulds in machinery molding, which can not only largely improve its surface smoothness but also reduce its surface check and internal stress. The unshrinkable and non-deformed product is convenient for stripping and molding to improve tremendously the production efficiency of the molding machinery.

Portable water chiller also applied to cooling machine tool, which can controls oil temperature precisely and reduces thermal deformation efficiently and improves machining precision. Besides, chilling water system which applies to beverage cooling can make high-temperature beverage reduced to a desired value to ensure quality of it and quicken industrial flow, etc.

4.3 Introduction of Refrigerant

R22

R22 is also called Freon, whose molecular formula is CHClF_2 . It is colorless gas under room temperature and can be liquefied into colorless and transparent liquid when pressurized. As the best refrigerant regarding to its combination property, R22 is the most widely used refrigerant all around the world with mature technology. It has stable and safe chemical composition, non- inflammability and high energy efficiency. Unfortunately, it damages the ozone sphere. The refrigerant pressure of R22 varies along with different temperature instead of other factors. The weight of the refrigerant can not be measured by the size of pressure.

Table 4-1: Saturation Temperature and Pressure of R22

Temp.		Pressure		Temp.		Pressure		Temp.		Pressure		Temp.		Pressure	
°C	°F	Psig	Kgf/cm ²	°C	°F	Psig	Kgf/cm ²	°C	°F	Psig	Kgf/cm ²	°C	°F	Psig	Kgf/cm ²
-20	-4.0	20.85	1.47	0	32.0	57.43	4.04	20	68.0	117.11	8.25	40	104.0	207.46	14.51
-19	-2.2	22.24	1.57	1	33.8	59.80	4.21	21	69.8	120.83	8.51	41	105.8	212.93	15.00
-18	-0.4	23.67	1.67	2	35.6	62.24	4.38	22	71.6	124.53	8.78	42	107.6	218.50	15.39
-17	1.4	25.14	1.77	3	37.4	64.73	4.58	23	73.4	128.51	9.05	43	109.4	224.16	15.79
-16	3.2	26.65	1.88	4	39.2	67.28	4.74	24	75.2	132.47	9.33	44	111.2	229.93	16.19
-15	5.0	28.86	1.99	5	41.0	69.90	4.92	25	77.0	135.52	9.61	45	113.0	235.79	16.61
-14	6.8	29.82	2.10	6	42.8	72.56	5.11	26	78.6	140.58	9.90	46	114.6	241.77	17.03
-13	8.6	31.47	2.22	7	44.6	75.32	5.30	27	80.6	144.84	10.20	47	116.6	247.85	17.45
-12	10.4	33.16	2.34	8	46.4	78.12	5.50	28	82.4	149.13	10.50	48	118.4	254.02	17.69
-11	12.2	34.90	2.46	9	48.2	80.99	5.70	29	84.2	153.49	10.81	49	120.2	260.31	18.33
-10	14.0	36.69	2.58	10	50.0	83.92	5.91	30	86.0	157.95	11.12	50	122.0	266.70	18.78
-9	15.8	38.53	2.71	11	51.8	86.93	6.12	31	87.8	162.49	11.44	51	123.8	273.22	19.24
-8	17.6	40.42	2.85	12	53.6	90.00	6.34	32	89.6	167.12	11.77	52	125.6	279.64	19.71
-7	19.4	42.36	2.98	13	55.4	93.13	6.56	33	91.4	171.85	12.10	53	127.4	285.58	20.18
-6	21.2	44.35	3.12	14	57.2	96.34	6.78	34	93.2	176.55	12.44	54	129.2	293.40	20.88
-5	23.0	46.40	3.27	15	59.0	99.62	7.02	35	95.0	181.56	12.79	55	131.0	300.36	21.15
-4	24.8	48.49	3.42	16	60.8	102.97	7.25	36	96.8	186.55	13.14	56	132.8	307.43	21.65
-3	26.6	50.64	3.57	17	62.6	106.39	7.49	37	98.6	191.63	13.50	57	134.6	314.62	22.16
-2	28.4	52.85	3.72	18	64.4	109.69	7.74	38	100.4	196.61	13.86	58	136.4	321.93	22.87
-1	30.2	55.11	3.88	19	66.2	113.46	7.99	39	102.2	202.08	14.23	59	138.2	329.35	23.19

R407C

R407c consists of R32/R125/R134a and 23/25/52wt%. The cooling capacity of unit volume, evaporation pressure, condensation pressure, exhaustion temperature and comprehensive thermal property is similar to R22, and its heat transfer coefficient is 10% lower than that of R22. Polyol Ester Oil is the lubricant adopted by the compressor. Before new refrigerant is poured into the system, all R407c should be discharged, with reduced filling charge and extended capillary.

R410A

R410A consists of R32/R125 and 50/50wt%. The condensing pressure of it is about 60% higher than that of R22, and the cooling capacity of unit volume is 50% more than that of R22. Under the same test condition, its heat transfer coefficient of condensation is about 2~6% higher and the pressure loss is 20~40% lower than that of R22, and heat transfer coefficient of evaporation is 20~30% higher than that of R22. System that uses R410A and Polyol Ester Oil is more compact than that uses R22. Before new refrigerant is poured into system, all R410A should be discharged before new refrigerant is poured into the system.

Table 4-2: Physical Property Comparison of R410A, R407C and R22

Items	R22	R407C	R410A
Components	R22 (100%)	R32/R125/R134a (23/25/52%)	R32/R125 (50/50%)
Molecular Weight	86.5	86.2	76.2
Boiling Point (°C)	-40.8	-43.8	-51.4
Operating Pressure Ratio	100%	About 108%	About 160%
Volume Ratio	100%	100%	68.5%
Power Ratio	100%	About 103%	About 107.7%
(MPa) Max. Working Pressure	2.60	2.60	4.15
Temperature Shift	Single Refrigerant (0°C)	Non-azeotropic Refrigerant Mixture(4~6°C)	(0.1°C) Near-azeotropic Refrigerant Mixture(0.1°C)
(ODP) Ozone Depletion Potential	0.055	0	0
(GWP) Ozone Warming Potential	1500	1530	1730

5. Standard Operation Working Condition for SIC/SICC

Table 5-1: Standard Operation Working Condition for SIC/SICC

Model	Standard working condition	
SICC-W	Cooling water inlet temperature	30°C
	Cooling water outlet temperature	35°C
	Cold water inlet temperature	12°C
	Cold water outlet temperature	7°C
SICC-A	Ambient temperature	35°C
	Cold water inlet temperature	12°C
	Cold water outlet temperature	7°C
SIC-W	Cooling water inlet temperature	30°C
	Cooling water outlet temperature	35°C
	Cold water inlet temperature	17°C
	Cold water outlet temperature	12°C
SIC-A	Ambient temperature	35°C
	Cold water inlet temperature	17°C
	Cold water outlet temperature	12°C

Remark:

- The relative running parameters of chillers (current and refrigerant capacity) was tested under standard working condition.
- When taken the actually measured data to analysis the faulty, these parameters based on standard working condition only reference but norm.
- Each model has its own operating range. It is meaningless to analysis faulty outside of operating range.

6. Solution Which SIC is Used in Industrial Refrigerant System

Information Source: Teco Group

Using Problem for All Year

- In winter, the temperature is too low, the refrigerant inside compressor dissolves into oil, so it is needed to equip with crankcase heaters so that separating refrigerant from oil. However the high pressure of refrigerate system is low, the resolution is:

For regions with minus temperature, the air-cooled water chillers should be used, at the same time, automatically adjusting the cooling air flow through switch on or off the cooling fan, which could be controlled by the high pressure value or outlet temperature (30°C) of condensor.

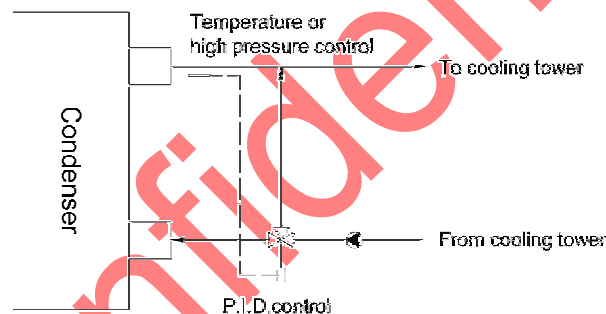

Picture 6-1: Adjusting Cooling Water Capacity by Three Way Valve

Available Temperature Range

Ensure the actual temperature within specified range; if it is too low, it is more possible to damage refrigerate system. If customers need that the temperature exceeds the specified range, please be careful:

- When water outlet and inlet temperature is high, it is needed to adjust outlet temperature by using heat exchanger and three way valve.

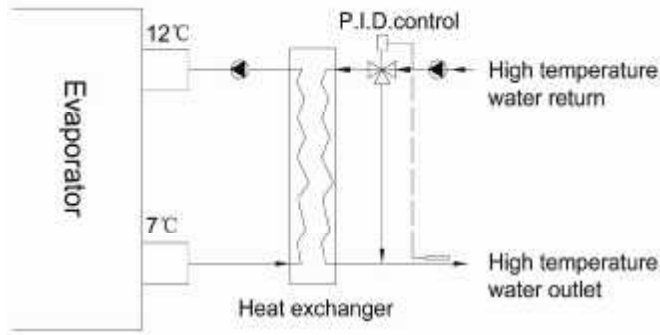

Picture 6-2: Adjusting Water Outlet Temperature by Three Way Valve

- When the outlet temperature is normal but water return temperature is high, it is needed to adjust water return temperature by three way valve.

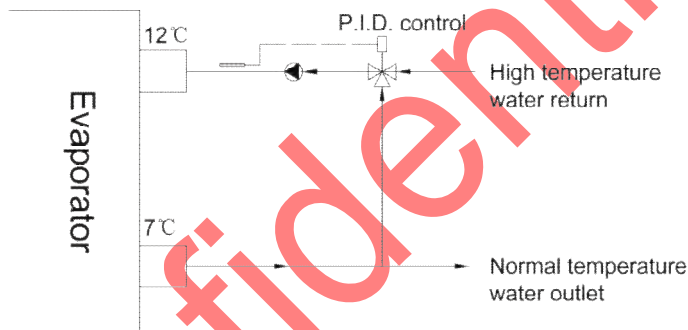

Picture 6-3: Adjusting Temperature by Three Way Valve

Request for High Precision Temperature Control

After compressor stops, considering the balance of high and low pressure and other problems, which can affect the refrigerate system performance, so there are some rules for the on/off times and switch frequency, in other word, compressor can not be started and stopped frequently.

The temperature control error of common thermostat is about $\pm 1.5^{\circ}\text{C}$. It is unacceptable to change the thermostat by oneself for meeting temperature control accuracy. If do need this requirement, it can be finished through projects. Please refer to following picture:

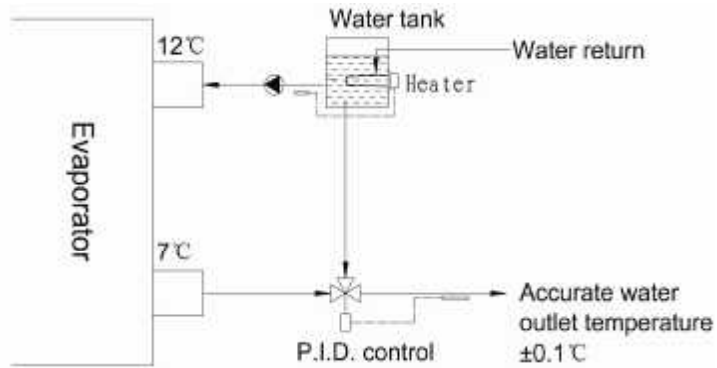

Picture 6-4: High Precision Temperature Control

Chemical Liquid and Oil Problem

At present, all models can not use medium except water and brine. If customers must use chemical liquid or oil as medium, it is possible to adopt following method:

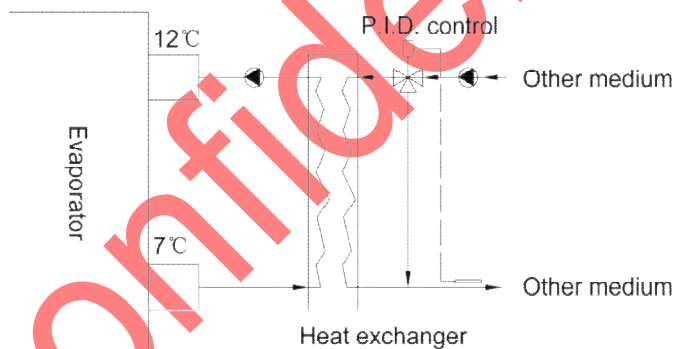

Picture 6-5: Use Chemical Liquid and Oil as Medium

In conclusion, all industrial cooling can be achieved by projects. But there are a few careful points:

- Load calculation must be right.
- Water outlet and inlet temperature should be within limited values forever.
- Water flow and current should be within limited values forever.

7. Factors of Affect Refrigerant Effect for SIC

Evaporative Temperature

The evaporative temperature of refrigerant inside the evaporator should be lower than ambient temperature so that the heat inside the machine room transfers to refrigerant. After refrigerant absorbs the heat, it will change from liquid state to air state.

With some calculation under constant condensing temperature, we can find that the lower the evaporating temperature is, the worse the cooling effect of a compressor is, the higher the air exhaust temperature is. The refrigerant inside evaporator within refrigerant cycle, whose evaporating temperature drop down 1°C, will make the electric consumption increase as 4% as before under producing same cooling capacity.

Open Scale of Expansion Valve

Open scale, which was adjusted before delivery, needn't commonly readjust it.

Condensing Pressure

- Condenser

An air cooling condenser consists of many groups of cooling coil whose outside surface adhere many fins to increase the cooling efficiency, at the same time, the cooling fan accelerates air flow to further increase the cooling effect. But the gap between each two fins that adhere outside surface of cooling coil is narrow, in addition, after long use time for air condition inside machine room, the bug, sundries and dust may adhere on the surface of the fins, which result in large air resistance and heat transmission resistance and bad heat exchanging performance, to reduce the cooling effect and raise high pressure.

- Unsuitable Condenser

Some firms who want to save cost and pursue optimum margin equipped

with smaller condenser intentionally which reduce the cooling effect. This situation should be avoided in design.

- Contain Air Inside System

If the vacuum level is not enough or filling medium operation is uncareful, it is easy to mix air. Air mixed into refrigerant system is harmful to refrigerant system. It can impact on the condensing temperature of refrigerant to result in working pressure increasing of condenser. For example, the practical condensing temperature is 35°C, the corresponding condensing pressure is just 12.5kgf/cm², but the actual value showing in the pressure meter may be 14kgf/cm², the surplus pressure of 1.5kgf / cm² just is the air pressure that mixing into the refrigerant system (based on Dalton law). Because the above reasons, the air discharging pressure and temperature increase, the refrigerant capacity reduces, electric consumption increases. In conclusion, the air must be removed from the system.

- Refrigerant was filled excessively, the condensing temperature also increase. The surplus refrigerant occupies certain area of condenser resulting in practical condensing area reducing and worst condensing effect.

8. Model Selection for SIC

8.1 Cooling Capacity Calculation

The total cooling power always consists of three parts: cooling mold (Q1), cooling molding machine (Q2), cooling hot runner (Q3), in other words, the total cooling capacity is $Q = Q1 + Q2 + Q3$. But in practical application, it is needed to figure out the suitable cooling capacity according to detail requirements.

Cooling Mold

As a matter of fact, one set of mold just is one heat exchanger. Heat quantity transmits from melted plastic to mold, and then from mold to constantly cycling ice water. Only are there a little heat quantity transmitted into air and molding plate. It is known that molding period of plastic, most of all is used for cooling, even occupied above 80%, so it must be necessary to control cooling time as minimum value.

$$Q1 = M \times S \times T \times \delta$$

Q1: refrigerant capacity, unit (kcal/h).

M: capacity per hour, unit: kg/hr

S: specific heat, unit: kcal/kg · °C

T: the temperature gap between the mold and the pp melting. normally we think it is 200°C.

δ : stands for the safely factor between 1.35~3.0.

The value of 1.35 is suitable for application of one SIC to one mold, but the value of 3.0 for one SIC to many sets of molds. If select air-cooled chillers, δ could also be 3.0, if used for below molding machine, δ could be 4.0.

For example:

A set of mold is used to mold PP products with output of 50kg/hr, how much is the needed cooling capacity? Which model is suitable for this application?

$$Q_1 = M \times S \times T \times \delta = 50 \text{ kg} \times 0.48 \text{ kcal} / \text{kg}^\circ\text{C} \times 200^\circ\text{C} \times 1.35 \\ = 6480 \text{ (kcal} / \text{hr)}$$

So the needed cooling capacity is 6480kcal / hr.

In fact, it is difficult to get the complete and accurate data. According to our experience for many years, the temperature gap T is usually 200°C, which is a collective average value amounts of common plastic products for many years.

Cooling Molding Machine

Cooling capacity for cooling molding machine relates to oil pump power of hydraulic molding machines or motor pump of electromotion molding machines and molding period. Please refer to following formula:

$$Q_2 = P \text{ (kW)} \times 860 \text{ (kcal} / \text{kW)} \times \delta$$

Q₂—refrigerant capacity, unit: kcal/hr.

P—motor power, unit: kW.

δ—factor

δ stands for the factor between 0.35~0.5. The value of 0.35 is suitable for commonly molding cycle (molding cycle is more than 10s), the value of 0.5 or more is suitable for rapidly molding cycle (molding cycle is 3~10s).

Cooling Hot Runner

If a molding machine equips with hot runner, please refer to following formula:

$$Q_3 = P \text{ (kW)} \times 860 \text{ (kcal} / \text{kW)} \times \delta$$

Q₃—refrigerant capacity, unit: kcal/hr.

P—hot runner power, unit: kW

δ—factor, this value usually ranges from 0.6~0.8.

8.2 Cycling Water Capacity

The cycling water capacity is defined according to performance of main unit in conjunction with load requirement on site and temperature gap (3~5°C) between water inlet and outlet for designed main unit.

It is needed to remove heat quantity of 6480 kcal / hr from molds, the temperature gap between water inlet and outlet is 5°C, so the minimum ice water flow is $L = 6480\text{kcal/hr} \div 5^\circ\text{C} \div 60\text{min} = 21.6(\text{L/min})$

Cooling Water Flow

$$L=Q \div (4.5\sim 5) \div 1.163 \times (1.15\sim 1.2)$$

L—needed cooling water flow, unit: m³/h

Q—refrigerant capacity of water chiller, unit: kW/hr

Cold Water Flow

$$L=Q \div (4.5\sim 5) \times 1.163$$

L—needed cold water flow, unit: m³/hr

Q—needed refrigerant capacity of molding machine, unit: kW/hr

SICC-60A Cooling Capacity Graph

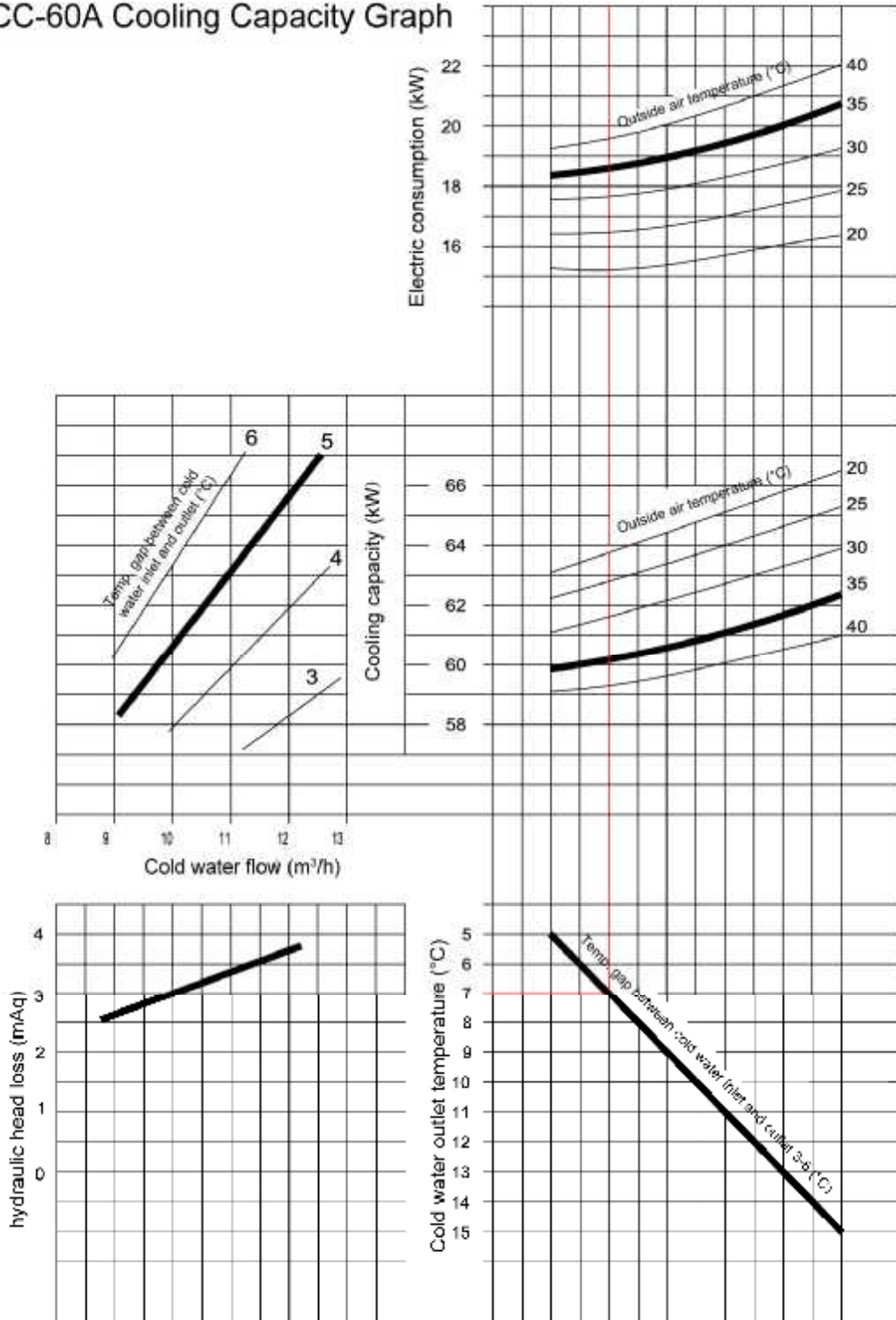

Picture 8-1: SICC-60A Cooling Capacity Graph

SICC-90A Cooling Capacity Graph

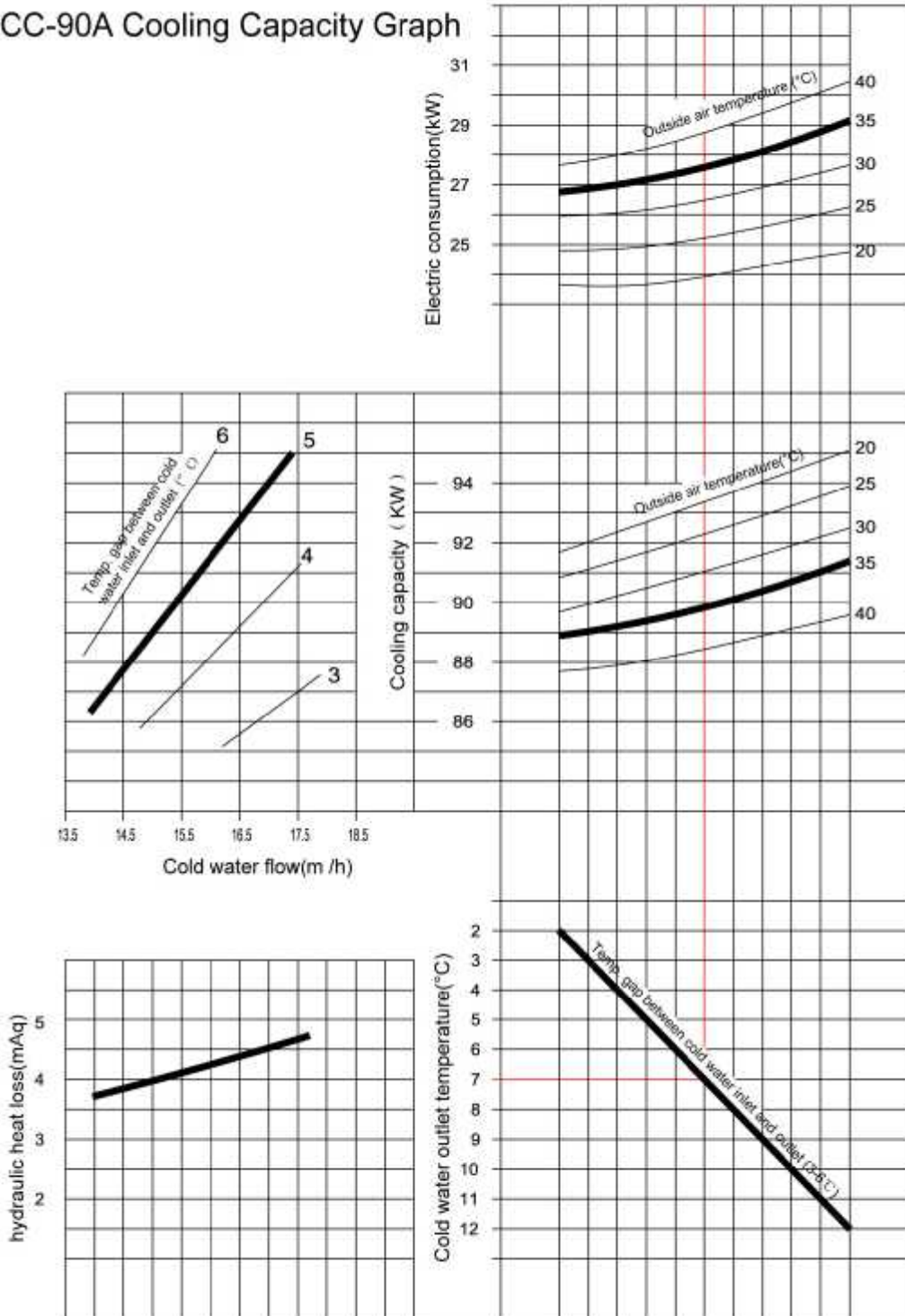

Picture 8-2: SICC-90A Cooling Capacity Graph

SICC-120A Cooling Capacity Graph

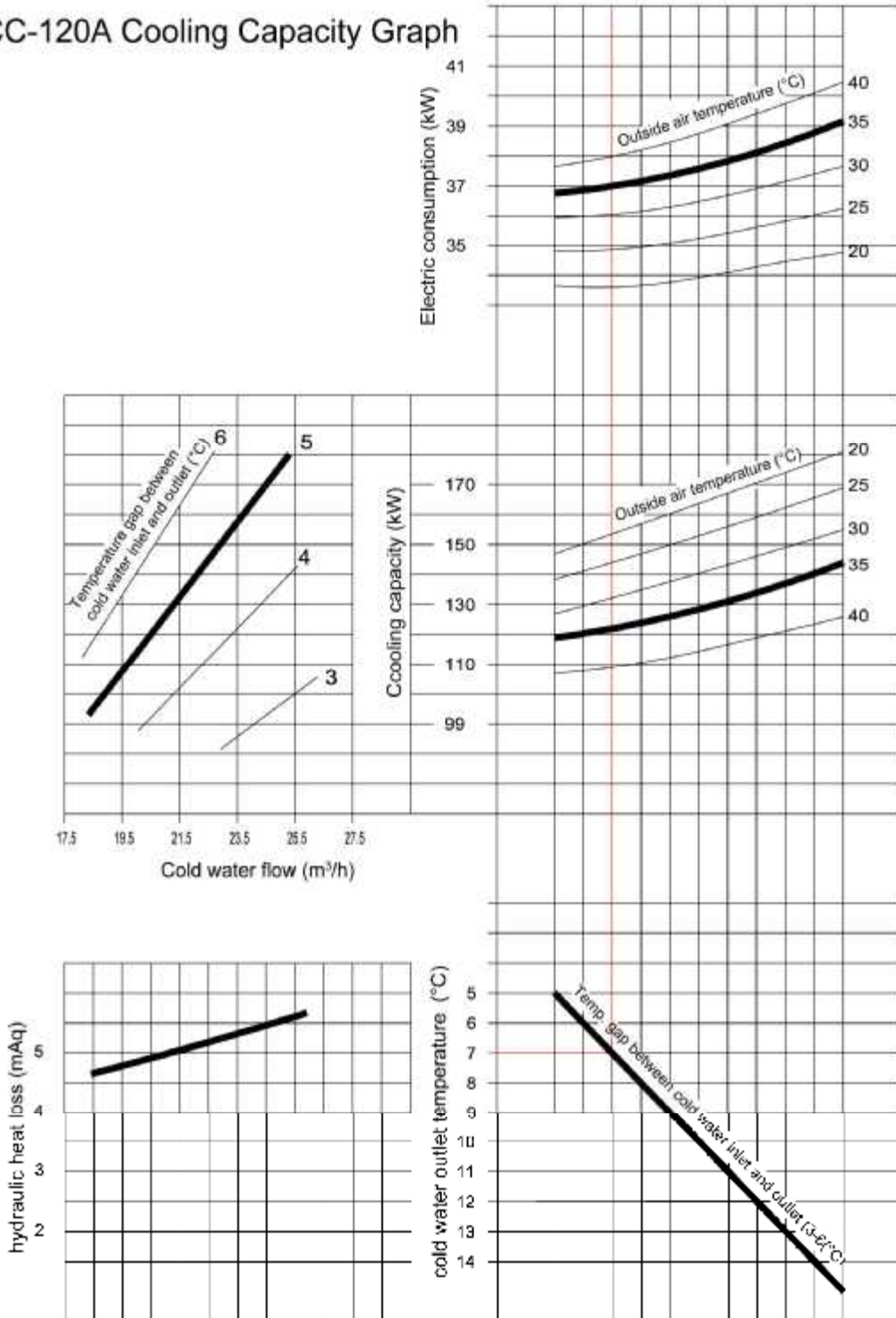

Picture 8-3: SICC-120A Cooling Capacity Graph

8.3 Cooling Tower

Model Selection for Cooling Tower

- At present, common cooling projects always adopt backflow fibre glass epoxy cooling tower with low noise or ultra-low noise, whose domestic code name is always DBNL-water flow (m³/hr), such as DBNL3-100, which represents water flow is 100 m³/h. Usually, the needed water flow can be defined by following formula:
Water flow (m³/hr)=(main unit cooling capacity kW + output power of compressor kW)/3.165
- Nominal water flow of Initially selective cooling tower should meet the requirement for water flow of main unit, simultaneously the water outlet and inlet temperature of cooling tower should coincide separately with the corresponding ones's of condenser of main unit, and then according to outdoor air wet bulb temperature on site, in conjunction with thermo performance curve of cooling tower determined by product stylebook, to confirm if the practical water flow is still no less than needed water flow for main unit.
- Confirm if structure and operation weight of the cooling tower can meet installation requirements on site.

Empirical Formulas

Assumed water flow of cooling tower

=total cooling capacity (kW) X860 (kcal / hr)/3000

Practical water flow=assumed water flow of cooling tower x (1.2~1.3)

8.4 Standard of Water Quality Used for SIC

When cooling water contacts with air, some of it evaporate to remove the latent heat, simultaneously cooling water will contaminated because of polluted air. The polluted cooling water can result in various of faults.

Harm to Poor Water

The faults resulted from bad water quality could be divided into three types: corrosion (condenser rupture), furring (high pressure fault), diatomaceous ooze (forming microbe), hereby are as follows:

- Corrosion

Corrosion of metal can result in water leakage. If the corrosion happens inside condenser to corrupt the cooling coils, the cooling pipes must be altered, even changing whole condenser. If the corrosion happens to produce rust that may block the cooling pipe, the high pressure switch will be activated, the repair cost will be expensive and the condensing capacity of condenser will change to be very bad. There are following few factors which may result in corrosion:

- Poor-quality water impact on metal with corrosion, standard quality water is shown in table 8-6.
- Even through the water quality is good, it can corrupt the metal after corrosion.
- The faster the water flow rate is, the quicker the corrupting process is. So cooling water capacity is best as standard.
- If the dust or silts mix into cooling coil and accumulate not to leave, it also can speeds up corrosion.
- Diatomaceous ooze also can speeds up the corrosion

- Furring

After the furring was formed on the surface of the cooling coil, not only does it prevent the heat exchanging, but also resulting in water flow reduction, and finally stop machine because of over high pressure. In addition, it can also accelerate condenser and cooling coil corrosion or producing tiny hole. There are following few causes which may formed furring:

- Cooling water contain following elements: CaCO_3 、 SiO_2 、Fe etc. After long use time of cooling water, water evaporates to result in the density of other elements increasing constantly until exceed their solubility to adhere on the surface of the cooling coils.
- The corrosive remain inside the cooling coils.
- Diatomaceous ooze, which was brought into cooling coils by water.
- Silts, which was mixed into cooling coils by water.
- Diatomaceous ooze

Diatomaceous ooze was formed under following condition, such as food, suitable temperature, oxygen and sunlight (sometime it is not needed). When the cooling tower is under the above condition, it will be soon blocked or corrupted.

Attentions to Cooling Water Quality

With industrial development for last years, the soot, which exhaust from the factories and office buildings, and the air exhausted from the automobiles, make the air pollution (SO_2) being serious increasingly. If using cooling tower under the above condition, the harmful gas can dissolve into water inside the cooling tower.

And this situation can result in water being worse increasingly. Because of the circular water flowing, the harmful elements may be concentrated. When the cooling coils of a condenser inside a chiller or a air condition use the above water, many kinds of corrosion faults may occur.

In addition, the place where was blown by the tidal wind, the Salinization phenomena of the cooling water may occur to corrupt the cooling coils. If using worse underground water, the same problem can occur. Once such problems occur, it is possible to badly impact on not only the cooling coils of a condenser, but also whole cooling system.

In order to protecting cooling coils prior to corrosion, please ensure using good quality water and filling corrosion inhibitor into water and refilling

new water in time, so that keeping water under good condition.

Chiller, cooling tower manufacturers in conjunction with water treatment chemical producer, based on the norm of the water quality management, study and discuss to provide a set of foolproof projects.

Table 8-1: Water Quality Standard

Items (ppm)		Water supplied standard	Cooling water standard	Trend	
				Corrosion	Furring
Basic factor	pH (25℃)	6.0~8.0	6.0~8.0	○	○
	Conductivity (25℃)(μ v/m)	(ppm) Below 200	Below 500(4)	○	
	cl ⁻	(ppm) Below 50	Below 200	○	
	SO ₄ ²⁻	(ppm) Below 50	Below 200	○	
	Fe	(ppm) Below 0.3	Below 1.0	○	○
	CaCO ₃	(ppm) Below 50	Below 100		○
	CaCO ₃	(ppm) Below 50	Below 200		○
Suggested factor	S ²⁻	(ppm) Unavailable	Unavailable	○	
	NH ₄ ⁺	(ppm) Unavailable	Unavailable	○	
	SiO ₂	(ppm) Below 30	Below 30		○

9. Q&A for SIC/SICC

Q: What are the functions of an expansion valve?

A: The expansion valve is a component, which can auto-adjust and auto-control the refrigerant capacity based on the principle of heat exchanging balance. Aside from choking effect, the expansion valve can auto-adjust the refrigerant capacity according to superheat degree change of refrigerant at the evaporator outlet, so that the refrigerant capacity can be compatible with the thermo load and keep superheat degree at setting value to give full play to evaporator efficiency.

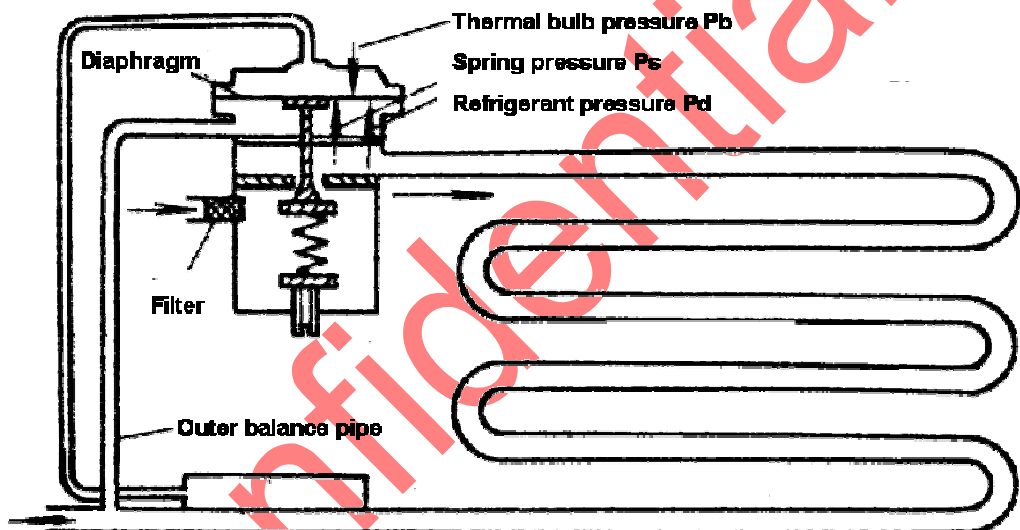

Picture 9-1: Thermo Expansion Valve Sketch

The expansion valve was installed at the evaporator inlet. The pressure (P_b) inside thermo bulb is saturated pressure which was produced by the superheat degree at the evaporator outlet. The capillary can transmit the pressure P_b forced against the surface of the diaphragm which can produce corresponding deformation according to the change of top and below action force. The transmission rod transmits the deformation of diaphragm to needle valve and simultaneously transmits the action force of spring back to diaphragm. The lower surface of the diaphragm bears the pressure of refrigerant. During working, diaphragm will bear three action forces: P_b , which is

from the thermo bulb; Ps, which comes from spring; Pz, which is from refrigerant.

No matter how changeable the working condition is, the expansion valve can auto-adjust the refrigerant capacity so that it can be compatible with the thermo load and keep superheat degree at setting value. Finally we get following equilibrium equation:

$$P_b = P_h + P_z$$

Q: What attentions do customers need to note during compressor working?

A: Limiting water content strictly.

Generally to speak, water content inside the refrigerant system should be less than 150mg. Lots of water enter into compressor, which can result in pump body rusting of compressors and block up compressors. If lots of water exists inside refrigerant system, the refrigerant system can be blocked by the ice during running, the refrigerant also can be hydrolyzed to produce acid substances. The copper can dissolve into refrigerant and lubricant seriously under acid condition. Dissolved copper ions will be separated out, when they contact with the iron or steel and accumulate on the surface of the steel parts, to produce a layer of copper diaphragm, this just is copper electroplating phenomena. The copper electroplating phenomena can impact badly on fit clearance and sealing effect of matched parts. Serious copper electroplating phenomena may directly result in fault of matched parts (such as slip sheet and vane-slot, piston and cylinder). Acid condition which results from water may speed up oil worse and burning out the motor, in addition, it also could produce carbon residue to reduce the use life of compressors.

Ensure enough vacuum level.

It is needed to vacuumize system enough prior to filling refrigerant. The requirement for vacuum level is to protect system from existing air. If the vacuum level is not enough, it is possible to produce following bad results: water vapor and air contained inside the system, worse

cold oil oxidation, refrigerant disassembled and immature gas, which can result in over high pressure of system, unstable working condition, over high temperature of exhaust air, even exploding appearance when the mixing scale of air and cold oil reach to certain value.

Harm of solid sundries.

If the solid impurity drop into refrigerant system, it is possible to block up the system and abrase the cylinder of the compressor, even block burning out the compressor. Hereby are some ways that solid impurity drop into refrigerant system: copper cuttings and impurity when cutting copper pipes, welding copper pipes without nitrogen protection, solid impurity drop into evaporator or condenser or refrigerant storage bin or the others because of unsuitable ways to store.

Q: What is Stepless adjustment function for refrigerant capacity?

A:

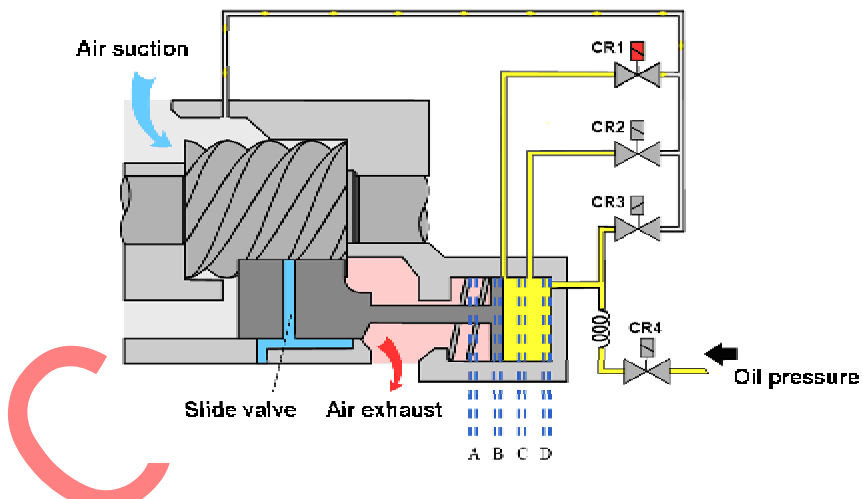

Picture 9-2: Stepless Adjustment Function Sketch

Hydraulic capacity control:

The hydraulic capacity control principle is shown in picture 9-2, the air suction capacity is adjust by slide valve movement. If moving the slide valve at left side (air suction side), the working space of screw will be filled fully with refrigerant; as the slide valve I approaching the air exhaust side, the working space of screw will get smaller, as well as

the refrigerant absorbed and flow and refrigerant capacity.

The slide valve is controlled by a piston. If valve (CR4) open, the oil pressure inside of the pressure room increases, the slide valve move to air suction side, so the refrigerant capacity increases.

If CR1 (75%), CR2 (50%) or CR3 (25%) open, hydraulic pressure which forced on the surface of the piston will get lower, air exhaust pressure push the piston moving to right side (air exhaust side), so the refrigerant capacity reduces.

100% (piston locates at the A): CR1, CR2 and CR3 close.

75% (piston locates at the B): CR1 opens, CR2 and CR3 close. As shown in picture)

50% (piston locates at the C): CR1 and CR3 close, CR2 opens.

25% (piston locates at the D): CR1 and CR2 close, CR3 opens.

The above is capacity adjustment principle with four stages. Hereby is the stepless capacity adjustment principle: as requirement for increasing refrigerant capacity, switch on/off the the power of CR4 with pulse signal (on for 0.5s and off for 5s) to move slowly the slide valve to air suction side, the refrigerant capacity also increases slowly. When the temperature meets setting value, switch off the power of solenoid valve to fix the slide valve, the refrigerant capacity also is kept at certain value. If requirement for reducing refrigerant capacity, switch on/off the the power of CR3 with pulse signal (on for 0.5s and off for 5s) to move slowly the slide valve to air exhaust side, the refrigerant capacity also increases slowly. Base on this working principle, the refrigerant capacity can be adjusted accurately within 25%~100%.

Statistic of running time for water-cooled water chiller: running time with worlining mode 100% occupy about 1% of the total, with 75% is 42%, with 50% is 45%, and with 25% is 12%.

Assumed that the electric consumption is 1 when working mode is 100%, so it is 0.75% when working mode is 75%, 0.57with50%, 0.48

with 25%.

The minimum stop time is 5 minutes, simultaneously constantly switched on the power of the CR3 to ensure slide valve located at right side, in case of starting the machine with load.

Maximum times of switched on/off machine per hour.

CSH/CSW 65/75 series: 6 times

CSH/CSW 85/95 series: 4 times

Minimum running time: 5 minutes

Q: What unit is LPM? Whether does Shini provide the SIC-5W-HP with pump flow 100LPM and the SIC-8W-HP with pump flow 180 LPM and pressure 3.5 ~ 4bar?

A: LPM is flow unit, it is just to say, liter per minute (L/min). Shini can provide SIC-5W-HP with maximum flow 116 L/min and maximum pressure 4.6bar, SIC-8W-HP with maximum flow 116 L/min and maximum pressure 5.5bar.

Q: Please select suitable model, which can provide cold water with 3m³/hr and 10°C, under ambient temperature 40~50°C and resupplying water temperature 42°C.

A: It is possible to select SICC-194WSH based on the above requirements. But the internal and external cycle pump is needed (internal circulating water flow is 26~30m³/hr and external circulating water flow is 3m³/hr), as well as corresponding control system and water tank with available capacity 1m³.

Q: What difference are there between SIC-A and SIC-A-P?

A: SIC-A adopts standard pump and SIC-A-P uses middle pressure pump, that is to say, pump pressure is different. The detail information please refers to product summary of SIC series.

Q: A customer installs newly two sets of product line:

Cooling water consumption for extruder 1: 35000 L/hr

Cooling water consumption for extruder 1: 14000 L/hr

Working pressure 4-8bar, please recommend suitable model.

A: The water flow of SICC-210A is 36100L/hr, which can meet customer's requirements, but it is needed to choose pump with working pressure 4~8bar and to specially make control system and water tank.

The water flow of SICC-90A is 15500L/hr, which can meet customer's requirements, but it is needed to choose pump with working pressure 4~8bar and to specially make control system and water tank.

If the customer uses one set of unit for two sets of product lines, it is possible to select SICC-300A with water flow 56800L/hr, but but it is needed to choose pump with working pressure 4~8bar and to specially make control system and water tank.

Q: A customer wants to know if chiller of Shini's can meet safety standard of IP65, in other words, whether it can be used outside of room?

A: The safety standard of IP65 require strictly for electric structure, now the product of Shini's can not meet this application.

Q: A customer want to purchase one set of chiller with working pressure 7bar and water flow 200L/min, please recommend suitable model.

A: It is possible to select SIC-15W, but some parts need to special make and water pump changes to CDLF16-60 with power 5.5kw.

Q: A customer wants to purchase one set of chiller with refrigerant capacity 10RT and water pump pressure 6bar and water flow 600LPM. Please recommend suitable model.

A: At present, the standard models of SIC-W/A don't meet this application. The degree of refrigerant capacity relates to the scale of water flow of chiller. The refrigerant capacity of 10RT is matched with maximum water flow of 100L/min~150L/min. If watr flow and load are too large, the water return temperature is also high (water return temperature is

about 5°C more than water inlet temperature), so the high pressure will be too high and the chiller can not work.

Q: Please recommend suitable model according to following parameter:

Hydraulic motor power:	15 kW;
Product output:	15 kg/hr;
Material:	PP
Water outlet temperature:	10°C;
Water return temperature:	15°C;
Ambient temperature:	32°C;
Water flow:	33 L/min;
Pump pressure:	3bar.

A: SIC-5W can meet this application.

Customer want to cooling hydraulic motor: we can get the needed refrigerant capacity ($15 \times 0.5 = 7.5$ kW) based on the empirical formula.

Needed refrigerant capacity for cooling product: $15 \times 0.46 \times 200 \times 2 = 2.76$ kW.

The total refrigerant capacity is $7.5 + 2.76 = 10.26$ kW, so we can know that the SIC-5W or SIC-5A is suitable according to the category.

The customer require for pump pressure of 3bar and water flow of 33L/min, so it is needed to equip with high pressure pump and finally the suitable model is SIC-5A/W-HP.

Q: A customer want to purchase a set of chiller with pump working pressure of 8kgf/cm² and water flow of 950L/min, please suggest a suitable model.

A: At present, all SIC models of Shini's can't meet this application for such a high water flow and pressure, but the SICC-W can. The customer can select the SICC-363WS, which can provide refrigerant capacity that can meet water flow of 63m³/hr, to finish the requirement for water flow, in addition, it is needed to equip with a set of CDLF65-30, whose maximum working pressure is 8kgf/cm² and maximum water flow is

65m³/hr.

Q: There are following parameters provided by a customer, please suggest a suitable model;

Maximum power: 400kW;

Range of the temperature: +10°C ~ +15°C;

Ambient temperature: + 45 °C;

Refrigerant capacity: 190 kW;

This chiller can work in desert condition.

A: The ambient temperature, which is 45°C, is so high that the air-cooled water chillers can not work normally because of insufficient cooling capacity. We recommend the customer to select water-cooled water chillers, but it is needed to ensure the cooling water temperature being no more than +35°C. Considering the refrigerant capacity of 190KW, we think that the SICC-223WS is suitable.

Confidential

10. Application Scope for STM

STM series mainly are used for heating and keeping constant temperature, it also can be used in other fields with same requirement.

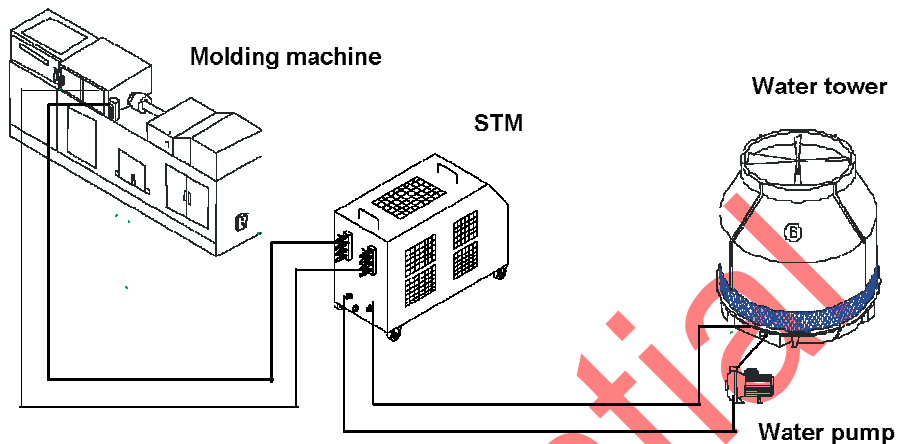

Picture 10-1: Projects Example for STM

11. Model Selection for STM

Example

Q: One customer wants to have a set of STM, he provides following parameters:

The medium is oil, mold weight is 300kg, specific heat of material made of mold is 0.115kcal/kg-°C, temperature gap between ambient and mold temperature is 40°C, the maximum temperature is 200°C, heating time is 1hr, temperature gap between water inlet and outlet is 5°C.

A: Calculation

Power (kw)=Mould weight (kg) × Mould Material Specific Heat (kcal/kg °C) × The Temperature Difference between Mould and environment 40(°C) Safety Factor/Heating Time ÷ 860

Safety Factor between 1.3~1.5

Flow (L/min)=Power (kw) × 860/[Hot Oil Specific Heat (kcal/kg °C) ×

Heat Oil Specific Gravity (kg/L) × The Temperature Difference between inside and outside × Time(60S)]

The Temperature Difference between inside and outside =0.49kcal/kg °C

Heat Oil Specific Gravity =0.842kg/L

According to Power and Flow, we know the model from catalogue.

Reference Answer:

$$\text{Power(kw)}=300(\text{kg}) \times 0.115(\text{kcal/kg } ^\circ\text{C}) \times 40(^{\circ}\text{C}) \times 1.3 \div (1 \times 860)=2.08\text{kw}$$

$$\text{Flow (L/min)}=2.08(\text{kw}) \times 860/[0.49(\text{kcal/kg } ^\circ\text{C}) \times 0.842(\text{kg/L}) \times 5 \times 60]=14\text{L/min}$$

STM-607 is suggested.

Confidential

12. Q&A for STM

Q: Why are the sizes of water inlet and outlet for STM different?

A: Usually the connectors at customer end are different from standard connectors of Shini. When meet this application, customers should in advance inform us the shape of connectors, H or PT, so that we can make special ones according to customer requirements.

Q: How much is the cooling capacity for STM-1220PW and which type of cooler was used?

A: The cooling capacity is 11.3kW, pressure of cooling water is 2~5kgf/cm², cooler with pipe was used.

Q: Whether could Shini provide one product which can control water flow for STM and water chillers? At present, we found that Shini has only SFR which can't be control by digital controller. A customer needs control each of machines because he uses many different sets of STM for many sets of molding machines. If shini can provide this special machine, the customer could equip the SICC or STM according to requirement of each of moling machine.

A: At present, Shini has unsuitable products for this application. We suggest that the customer could install a water flow meter, which only shows but controls flow, within pipe cycle.

13. Reference Informations

13.1 Unit Converter

Table 13-1: Temperature Conversion

Celsius Degress	Fahrenheit Degress	Absloute Humidity
-273.15	-459.4	0
2	32	273.15
100	212	373.15
$^{\circ}\text{C} = (^{\circ}\text{F} - 32) * 5/9$ $^{\circ}\text{F} = (^{\circ}\text{C} * 9/5) + 32$ $^{\circ}\text{K} = ^{\circ}\text{C} + 273.15$		

Table 13-2: Energy Conversion

Joule	Kcal	kW/hr	BTU
1	$2.39 * 10^{-4}$	$2.778 * 10^{-7}$	$9.486 * 10^{-4}$
4187	1	$1.162 * 10^{-3}$	3.968
$3.6 * 10^6$	860	1	3413
1.356	$3.239 * 10^{-4}$	$3.766 * 10^{-7}$	$1.285 * 10^{-3}$
1055	0.252	$2.928 * 10^{-4}$	1

Table 13-3: Pressure Conversion

Bar	kPa	Mpa	kgf/cm ²	Water Gauge(m)	Psi
1	100	0.1	1.02	10.2	14.5
0.01	1	0.001	0.0102	0.102	0.145
10	1000	1	10.2	102	145
0.9807	98.07	0.09807	1	10	14.22
0.06895	6.895	$6.895 * 10^{-3}$	0.0703	0.703	1
0.09807	9.807	$9.807 * 10^{-3}$	0.1	1	1.422

13.2 Optional Pump Parameters for SIC

Table 13-4: Middle Pressure Pump Parameters (50Hz)

Model	Pump Model	Flow / Pressure	Max Flow	Max Pressure
SIC-3W	CHLF(T)4-40(0.75kW)	83L/min 2.6bar	117L/min	3.8bar
SIC-4W	CHLF(T)4-40(0.75kW)	83L/min 2.6bar	117L/min	3.8bar
SIC-5W	CHLF(T)4-40(0.75kW)	83L/min 2.6bar	117L/min	3.8bar
SIC-8W	CHLF(T)4-50(1.1kW)	100L/min 2.6bar	117L/min	4.6bar
SIC-10W	CHLF(T)4-50(1.1kW)	100L/min 2.6bar	117L/min	4.6bar
SIC-12.5W	CHLF(T)8-40(1.5kW)	150L/min 3.0bar	183L/min	3.9bar
SIC-15W	CHLF(T)8-40(1.5kW)	150L/min 3.0bar	183L/min	3.9bar
SIC-20W	CHLK16-30(3.0kW)	300L/min 3.0bar	366L/min	3.85bar
SIC-25W	CHLK16-30(3.0kW)	300L/min 3.0bar	366L/min	3.85bar
SIC-30W	CHLK16-30(3.0kW)	300L/min 3.0bar	366L/min	3.85bar
SIC-40W	CHLK16-30(3.0kW)	300L/min 3.0bar	366L/min	3.85bar
SIC-45W	CDL16-40(4.0kW)	333L/min 3.8bar	366L/min	5.4bar
SIC-50W	CDL16-40(4.0kW)	333L/min 3.8bar	366L/min	5.4bar

Table 13-5: Middle Pressure Pump Parameters (60Hz)

Model	Pump Model	Flow/Pressure	Max Flow	Max Pressure
SIC-3W	CHLF(T)2-30(0.75kW)	50L/min 2.7bar	66L/min	3.8bar
SIC-4W	CHLF(T)2-30(0.75kW)	50L/min 2.7bar	66L/min	3.8bar
SIC-5W	CHLF(T)2-30(0.75kW)	50L/min 2.7bar	66L/min	3.8bar
SIC-8W	CHLF(T)4-30(1.1kW)	100L/min 2.8bar	133L/min	3.9bar
SIC-10W	CHLF(T)4-30(1.1kW)	100L/min 2.8bar	133L/min	3.9bar
SIC-12.5W	CHLF(T)8-30(2.2kW)	150L/min 3.7bar	216L/min	4.1bar
SIC-15W	CHLF(T)8-30(2.2kW)	150L/min 3.7bar	216L/min	4.1bar
SIC-20W	CHLF(T)8-40(3.0kW)	200L/min 3.9bar	216L/min	5.5bar
SIC-25W	CHLF(T)8-40(3.0kW)	200L/min 3.9bar	216L/min	5.5bar
SIC-30W	CHLK16-30(5.5kW)	400L/min 3.2bar	467L/min	4.9bar
SIC-40W	CHLK16-30(5.5kW)	400L/min 3.2bar	467L/min	4.9bar
SIC-45W	CDL16-30(5.5kW)	400L/min 4.0bar	433L/min	5.7bar
SIC-50W	CDL16-30(5.5kW)	400L/min 4.0bar	433L/min	5.7bar

Table 13-6: High Pressure Pump Parameters (50Hz)

Model	Pump Model	Flow/Pressure	Max Flow	Max Pressure
SIC-3W	CHLF(T)4-50(1.1kW)	67L/min 3.8bar	117L/min	4.6bar
SIC-4W	CHLF(T)4-50(1.1kW)	67L/min 3.8bar	117L/min	4.6bar
SIC-5W	CHLF(T)4-50(1.1kW)	67L/min 3.8bar	117L/min	4.6bar
SIC-8W	CHLF(T)4-60(1.1kW)	89L/min 3.5bar	117L/min	5.5bar
SIC-10W	CHLF(T)4-60(1.1kW)	89L/min 3.5bar	117L/min	5.5bar
SIC-12.5W	CHLF(T)8-50(2.2kW)	133L/min 4.2bar	183L/min	4.9bar
SIC-15W	CHLF(T)8-50(2.2kW)	133L/min 4.2bar	183L/min	4.9bar
SIC-20W	ZS50-32-200(4.0kW)	300L/min 4.2bar	333L/min	5.29bar
SIC-25W	ZS50-32-200(4.0kW)	300L/min 4.2bar	333L/min	5.29bar
SIC-30W	ZS50-32-200(4.0kW)	300L/min 4.2bar	333L/min	5.29bar
SIC-40W	ZS50-32-200(4.0kW)	300L/min 4.2bar	333L/min	5.29bar
SIC-45W	CDL16-50(5.5kW)	333L/min 4.8bar	367L/min	6.8bar
SIC-50W	CDL16-50(5.5kW)	333L/min 4.8bar	367L/min	6.8bar

Table 13-7: High Pressure Pump Parameters (60Hz)

Model	Pump Model	Flow/Pressure	Max Flow	Max Pressure
SIC-3W	CHLF(T)4-40(1.5kW)	100L/min 3.8bar	133L/min	5.3bar
SIC-4W	CHLF(T)4-40(1.5kW)	100L/min 3.8bar	133L/min	5.3bar
SIC-5W	CHLF(T)4-40(1.5kW)	100L/min 3.8bar	133L/min	5.3bar
SIC-8W	CHLF(T)4-40(1.5kW)	100L/min 3.8bar	133L/min	5.3bar
SIC-10W	CHLF(T)4-40(1.5kW)	100L/min 3.8bar	133L/min	5.3bar
SIC-12.5W	CHLF(T)8-30(2.2kW)	117L/min 4.0bar	216L/min	4.1bar
SIC-15W	CHLF(T)8-30(2.2kW)	117L/min 4.0bar	216L/min	4.1bar
SIC-20W	CHLF(T)8-50(3.0kW)	200L/min 4.9bar	216L/min	6.9bar
SIC-25W	CHLF(T)8-50(3.0kW)	200L/min 4.9bar	216L/min	6.9bar
SIC-30W	CHLK16-30(5.5kW)	267L/min 4.4bar	467L/min	4.9bar
SIC-40W	CHLK16-30(5.5kW)	267L/min 4.4bar	467L/min	4.9bar
SIC-45W	CDL16-30(5.5kW)	400L/min 4.0bar	433L/min	5.7bar
SIC-50W	CDL16-30(5.5kW)	400L/min 4.0bar	433L/min	5.7bar

13.3 Specific Heat List of Material

Table 13-8: Specific Heat List of Material

Material	Drying Temp. (°C)	Bulk Density (kg/L)	Drying Time (hr)	Specific Heat (kcal/kg-°C)
ABS	80	0.6	2~3	0.34
CA	75	0.5	2~3	0.5
CAB	75	0.5	2~3	0.5
CP	75	0.6	2~3	0.6
LCP	150	0.6	4	0.6
PA	70~80	0.65	3~6	0.4
PBT	120~140	0.7	4	0.5
PC	120	0.7	2~3	0.28
PE	90	0.6	1	0.55
PEI	150	0.6	3~4	0.6
PEN	170	0.85	5	0.85
PES	150~180	0.7	4	0.7
PET	160~180	0.85	4~6	0.5
PETG	60~70	0.6	4~6	0.6
PI	120~140	0.6	3	0.27
PMMA	70~100	0.65	3	0.65
POM	95~110	0.6	3	0.35
PP	90	0.5	1	0.46
PPO	110~125	0.5	2	0.4
PPS	140~150	0.6	3~4	0.6
PS	80	0.5	1	0.28
PSU	120~170	0.65	4	0.31
PVC	70	0.5	1	0.2
SAN	80	0.5	2~3	0.32
TPE	105	0.7	3	0.7

Remark: the above data is used for model selection for reference only. During actual application, please according to the data provided by material suppliers.

13.4 Cooling Parameter Table for STM

Table 13-9: Cooling Parameter for STM

Model	Max Pressure of Pump (kgf/cm ²)	Max Water Flow of Pump (L/min)	Working temp. (°C)	Cooling Capacity (kW)
STM-607	3.8	27	200	5.93
STM-910	5.0	42	200	9.12
STM-1220	6.2	74	200	11.31
STM-2440	8.0	90	200	18.7
STM-3650	8.0	100	200	24.68
STM-907HT	4.8	28	300	12.82
STM-1215HT	5.8	58	300	17.45
STM-2440HT	8	100	300	28.51
STM-607PW	3.8	27	160	8.4
STM-910PW	5.0	42	160	10.17
STM-1220PW	6.2	74	160	11.3
STM-607W/O	3.4	55	160	4.64
STM-907W/O	3.4	55	160	5.76
STM-1207W/O	3.4	55	160	6.5
STM-304W	4.0	12	120	33.2
STM-607W	3.8	27	120	33.2
STM-910W	5.0	42	120	33.2
STM-1220W	6.2	74	120	36.37
STM-2440W	8.0	90	120	39.22
STM-3650W	8.0	100	120	53.2

Remark: the above data is suitable for application without loading; the application with loading is based on practical requirements.

Version

No.	Page (P) Chapter (C)	Description	Date Dep./Name
1		New Document	2010-04-01 TM/Henry Chang
2		Revising coding principle	2010-10-19 TM/Gavinbai
2		New brand image	2013-04-28 TM/Gavinbai

Confidential

Feedback Form

Thank you very much for taking time to read this application guide. We have been committed to assisting sales staffs to select proper products for customers and improve their application proficiency. Editors are eager for your precious opinions and suggestions to perfect the contents and forms of this application guide, which is also a spur for us.

1. Your general feeling about this manual:

- Perfect Common Not good

2. Your opinion about format and layout of this manual:

- Perfect Common Not good

3. Do you think this manual is helpful for model selection and application?

- Of great help Not much Not at all

4. Which content is of great help for you?

5. What should be added to this manual?

6. From what aspects does this journal need to be improved?

Your Name: _____

Contact Information: _____

Please fill out this form and send it back to us by:

Fax: +86-769-8111-6611