

# **STM-MW** Series

**Water Heater**

Date: Sep. 2018

Version: Ver.F (English)





## Contents

<b>1. General Description .....</b>	<b>7</b>
1.1 Coding Principle .....	8
1.2 Feature .....	8
1.3 Options .....	8
1.4 Technical Specifications .....	10
1.4.1 Specification .....	10
1.4.2 Pump Performance .....	10
1.4.3 Reference Formula of Mould Controllers Model Selection .....	11
1.5 Safety Regulations .....	12
1.5.1 Safety Signs and Labels .....	12
1.5.2 Signs and Labels .....	13
1.5.3 Operation Regulations .....	14
1.5.4 Transportation and Storage of the Machine .....	15
1.6 Exemption Clause .....	17
<b>2. Structure Characteristics and Working Principle .....</b>	<b>18</b>
2.1 Main Functions .....	18
2.2 Working Principle .....	18
<b>3. Installation and Debugging .....</b>	<b>20</b>
3.1 Installation Space .....	20
3.2 Mould and Water Coupling .....	20
3.3 Power Supply .....	21
3.4 Options Installation .....	22
3.4.1 Installation steps for options water manifold (dewaxing) .....	22
3.4.2 Installation steps for options water manifold (welding) .....	22
<b>4. Operation Guide .....</b>	<b>24</b>
4.1 Control Panel .....	24
4.2 Menu Introduction .....	27
4.3 Machine Startup .....	28
4.4 Stop the Machine .....	38

<b>5. Trouble-shooting .....</b>	<b>40</b>
<b>6. Maintenance and Repair .....</b>	<b>42</b>
6.1 Open the Covers .....	43
6.2 Y Type Strainer .....	44
6.3 Solenoid Valve .....	44
6.4 Pipe Heater .....	45
6.5 By-pass Globe Valve.....	46
6.6 Printed Circuit Board .....	46
6.7 Maintenance Schedule.....	49
6.7.1 About the Machine.....	49
6.7.2 Installation & Inspection.....	49
6.7.3 Daily Checking.....	49
6.7.4 Weekly Checking .....	49
6.7.5 Trimonthly Checking.....	49
6.7.6 Half-yearly Checking.....	49
6.7.7 Yearly Checking.....	50
6.7.8 3 year Checking.....	50

### Table Index

Table 1-1: Specification .....	10
Table 4-1: Control Panel.....	24
Table 4-2: Error Type.....	26

### Picture Index

Picture 1-1: Pump Performance .....	10
Picture 2-1: Working Principle .....	18
Picture 3-1: Installation Space .....	20
Picture 3-2: Mould and Water Couplings 1 .....	20
Picture 3-3: Mould and Water Couplings 2 .....	21
Picture 3-4: Mould and Water Couplings 3 .....	21
Picture 4-1: Control Panel.....	24

Pictute 4-2: Menu Outline .....	27
Picture 4-3: Main Power Switch .....	28
Picture 4-4: Initial Menu .....	28
Picture 4-5: Control Setting Screen .....	29
Picture 4-6: Alarm Setting Screen.....	30
Picture 4-7: Output Setting Screen .....	31
Picture 4-8: Temperature Setting Screen .....	33
Picture 6-1: Open the Covers 1 .....	43
Picture 6-2: Open the Covers 2 .....	43
Picture 6-3: Open the Covers 3 .....	43
Picture 6-4: Y Type Strainer .....	44
Picture 6-5: Solenoid Valve .....	44
Picture 6-6: Pipe Heater 1 .....	45
Picture 6-7: Pipe Heater 2 .....	45
Picture 6-8: Pipe Heater 3 .....	45
Picture 6-9: By-pass Globe Valve .....	46



# 1. General Description



Read this manual carefully before operation to prevent damage of the machine or personal injuries.

STM-MW series water heater are used to heat up the mould and maintain temperature, although they can be used in other similar applications. High temperature water from the mould is returned to the cooling tank and cooled by either indirect cooling (For high temperature models) or direct cooling (for standard models). It is then pressurised by the high - pressure pump, sent to the heating tank and finally to the mould with a constant temperature. The HANYOUNG temperature controller can maintain an accuracy of  $\pm 1^{\circ}\text{C}$ .



Model: STM-910MW

## 1.1 Coding Principle

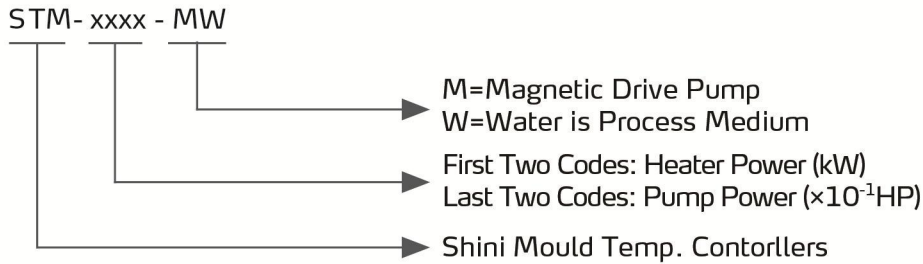

## 1.2 Feature

- Controller adopts 3.2" LCD for easy operation.
- Equipped with the design of 7-day automatic start/stop timer. LCD screen can be converted between Chinese and English. The unit of temperature can be converted between °F and °C.
- P.I.D. multi-stage temperature control system can maintain a mould temperature with accuracy of  $\pm 0.5^{\circ}\text{C}$ .
- Adopts high efficiency water cycle pump, which can meet the demands of temperature control for precise moulds and mould loop with minor diameter to achieve precise temperature control and high efficient heat exchange. Pump inside adopts stainless steel to avoid explosion.
- Multiple safety devices including power reverse phase protection, pump overload protection, overheat protection and low level protection that can automatically detect abnormal performance and indicate this via visible alarm.
- For standard STM-MW, the heating temperature can reach  $120^{\circ}\text{C}$
- Equipped with high pressure protection, safety pressure relieving, automatic water supplying and air exhausting.
- Adopted Ethernet communication function to realize central monitoring online.

## 1.3 Options

- Water manifolds and Teflon hose are optional.
- Displays of mold temperature and return water temperature of mold are optional.
- Buzzer is optional .Add "B" at the model behind.



- Water-removing of air blowing, add "A" at the end of the model code.
- It could option with magnetic filter to prolong service life of magnetic pump. Add "MF" at the end of the model code.

All service work should be carried out by a person with technical training or corresponding professional experience. The manual contains instructions for both handling and servicing. Chapter 6, which contains service instructions intended for service engineers. Other chapters contain instructions for the daily operator.

Any modifications of the machine must be approved by SHINI in order to avoid personal injury and damage to machine. We shall not be liable for any damage caused by unauthorized change of the machine.

Our company provides excellent after-sales service. Should you have any problem during using the machine, please contact the company or the local vendor.

Headquarter and Taipei factory:

Tel: (886) 2 2680 9119

Shini Plastics Technologies (Dongguan), Inc:

Tel: (86) 769 8111 6600

Shini Plastics Technologies India Pvt.Ltd.:

Tel: (91) 250 3021 166

## 1.4 Technical Specifications

### 1.4.1 Specification

Table 1-1: Specification

Model	STM-607MW	STM-910MW	STM-1220MW	STM-2440MW
Ver.	E	E	F	F
Max. Temp.	120℃	120℃	120℃	120℃
Pipe Heater(kW)	6	9	12	24
Pump Power(kW) (50 / 60Hz)	0.55 / 0.63	1.0 / 1.2	1.0 / 1.2	2.8 / 3.4
Max. pump Flow (L / min)(50 / 60Hz)	25.5 / 30.6	50 / 60	50 / 60	62.5 / 75
Max. pump Pressure (bar)(50 / 60Hz)	4.2 / 5.04	5.8 / 6.96	5.8 / 6.96	7.3 / 8.76
Heating Tank Number	1	1	1	2
Heating tank capacity (L)	3.0	3.0	3.0	7.4
Cooling Method	Indirect	Indirect	Indirect	Indirect
Mould Coupling*(inch)	3/8" (2×2)	3/8" (2×2)	3/8" (4×2)	1"(1×2)
Inlet/Outlet (inch)	3/4 / 3/4	3/4 / 3/4	1 / 1	1 / 1
Dimensions (mm) (H×W×D)	620×320×865	620×320×865	695×340×815	870×360×930
Weight (kg)	55	60	120	140

Note: 1) In order to maintain stable temp. of heat transfer media (120℃), cooling water pressure should be no less than 2 kgf/cm<sup>2</sup>, but also no more than 5 kgf/cm<sup>2</sup>.

2) Pump testing standard : Power of 50 / 60Hz, purified water at 20℃.  
( There is ± 10% tolerance for either max. flowrate or max.pressure ).

3) Power supply: 3Φ, 230/400/460/575V, 50/60Hz.

4) "\*\*\*\*" stands for for heating the machine to 140℃, cooling water pressure should not be lower than 4kgf/cm<sup>2</sup>.

We reserve the right to change specifications without prior notice.

### 1.4.2 Pump Performance

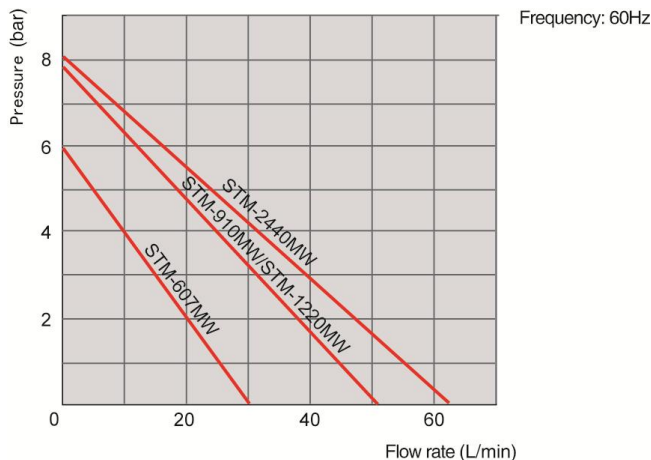

Picture 1-1: Pump Performance

### 1.4.3 Reference Formula of Mould Controllers Model Selection

Heater Power (kW) = mould weight (kg) × mould specific heat (kcal/kg°C) × temperature difference between mould and environment (°C) × safety coefficient / heating duration / 860

Note: safety coefficient can select a value from 1.3 to 1.5.

Flow Rate (L/min) = heater power (kw) × 860 / [heating medium specific (kcal/kg°C) × heating medium density (kg/L) × in/outlet temperature difference (°C) × time (60)]

Note: Water specific heat =1kcal/kg°C

Heating medium oil specific heat =0.49kcal/kg°C

Water density =1kg/L

Heating medium oil density =0.842kg/L

## 1.5 Safety Regulations

Strictly abide by the following safety regulations to prevent damage of the machine or personal injuries.

### 1.5.1 Safety Signs and Labels



**Danger!**

The unit is designed to endure high temp, and high pressure. For safe operation, do not remove the covers or switches.



**Attention!**

The unit should be operated by qualified personnel only.

During operation, avoid wearing gloves or clothes that may cause danger.

Turn off main switch when power supply is off.

Stop the unit when there may be power supply problems caused by static electricity.

Put on safety gloves and shoes during installation or relocation.

Components from our company can only be used for replacement.



**Warning!**

Do not touch the switch with wet object or hands.

Do not use the machine before fully aware of its performance.

Be careful not to touch or hit the switch or sensor.

Please keep enough operation space, and keep away obstacles.

To avoid producing statics, clean the floor from oil or water to keep a dry environment.

Protect the machine against severe vibration or collision.

Do not remove safety signs or make it dirty.



Drunken, medicine-taking, or men without proper judgement should not operate the machine.



**Warning!**

High temperature, take care of hands! This label is attached on the surface of heating parts.

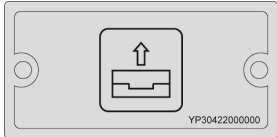
## 1.5.2 Signs and Labels

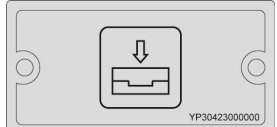
<div style="background-color: yellow; border: 1px solid black; padding: 10px;"> <p style="text-align: center;"><b>Maintenance Schedule</b></p> <table border="1" style="width: 100%; border-collapse: collapse;"> <thead> <tr> <th style="width: 70%;">Item</th> <th style="width: 30%;">CT</th> </tr> </thead> <tbody> <tr> <td>Check whether pipeline joints are under looseness.</td> <td>Weekly</td> </tr> <tr> <td>Clean Y-type filter.</td> <td>Weekly</td> </tr> <tr> <td>Clean solenoid valve.</td> <td>Monthly</td> </tr> <tr> <td>Check the sensitivity of EGO.</td> <td>Weekly</td> </tr> <tr> <td>Check level switch.</td> <td>Trimonthly</td> </tr> <tr> <td>Check contactor.</td> <td>Trimonthly</td> </tr> <tr> <td>Clean process heater/cooler.</td> <td>Semiyearly</td> </tr> <tr> <td>Check indicator and buzzer.</td> <td>Semiyearly</td> </tr> <tr> <td>PCB renewal.</td> <td>Every 3 year exchange</td> </tr> <tr> <td>No fuse breaker.</td> <td>Every 3 year exchange</td> </tr> <tr> <td rowspan="3">Thermal oils</td> <td>≤ 120°C</td> <td>Renew annually</td> </tr> <tr> <td>120°C~160°C</td> <td>Renew semiyearly</td> </tr> <tr> <td>&gt; 160°C</td> <td>Renew trimonthly</td> </tr> </tbody> </table> <p style="font-size: small; margin-top: 5px;">Note: Please refer to the Manual for detailed operations.</p> <p style="text-align: right; font-size: x-small;">YP31115800700</p> </div>	Item	CT	Check whether pipeline joints are under looseness.	Weekly	Clean Y-type filter.	Weekly	Clean solenoid valve.	Monthly	Check the sensitivity of EGO.	Weekly	Check level switch.	Trimonthly	Check contactor.	Trimonthly	Clean process heater/cooler.	Semiyearly	Check indicator and buzzer.	Semiyearly	PCB renewal.	Every 3 year exchange	No fuse breaker.	Every 3 year exchange	Thermal oils	≤ 120°C	Renew annually	120°C~160°C	Renew semiyearly	> 160°C	Renew trimonthly	<p>Please according to schedule to make regular maintenance.</p>
Item	CT																													
Check whether pipeline joints are under looseness.	Weekly																													
Clean Y-type filter.	Weekly																													
Clean solenoid valve.	Monthly																													
Check the sensitivity of EGO.	Weekly																													
Check level switch.	Trimonthly																													
Check contactor.	Trimonthly																													
Clean process heater/cooler.	Semiyearly																													
Check indicator and buzzer.	Semiyearly																													
PCB renewal.	Every 3 year exchange																													
No fuse breaker.	Every 3 year exchange																													
Thermal oils	≤ 120°C	Renew annually																												
	120°C~160°C	Renew semiyearly																												
	> 160°C	Renew trimonthly																												
<div style="display: flex; align-items: center;"> <div style="background-color: yellow; border: 1px solid black; padding: 5px; width: 30%;"> <p style="text-align: center; margin: 0;"><b>WARNING</b></p> <p style="font-size: x-small; margin: 0;">1. Before starting, please refer to operation section of the manual.</p> <p style="font-size: x-small; margin: 0;">2. Water is used as the heat transfer medium. The maximum temperature setting value is 120°C(248°F).</p> </div> <div style="width: 65%; text-align: center;">  <p style="font-size: x-small; margin-top: 5px;">YP31012180000</p> </div> </div>	<ol style="list-style-type: none"> <li>1. Before starting, please refer to operation section of the manual.</li> <li>2. Water is used as the heat transfer medium. The maximum temperature setting value is 120°C (248 °F).</li> </ol>																													
 <p style="font-size: x-small; text-align: right;">YP30422000000</p>	<p>From mould: connector for circulating water/oil coming from mould.</p>																													
 <p style="font-size: x-small; text-align: right;">YP30425000000</p>	<p>Pump pressure meter: indicating actual pressure of system.</p>																													
 <p style="font-size: x-small; text-align: right;">YP30423000000</p>	<p>To mold: connector for circulating water/ oil to go to mould.</p>																													

	<ol style="list-style-type: none"> <li>1. To maintain temperature consistency, cooling water pressure must be higher than 2 bar at all time, but should never exceed 5 bar in any case.</li> <li>2. Clean Y-shape Cooling Water Strainer periodically to ensure perfect cooling capacity.</li> </ol>
	<p>Water outlet: drainage outlet.</p>
	<p>Water inlet: inlet for replenishing water and cooling water.</p>

Please abide by the safety guide when you operate the machine so as to prevent damage of the machine and personal injuries.



All electrical components should be installed by qualified electricians. Turn off main switch and control switch during repair and maintenance.



Warning! High voltage!

This mark is attached on the cover of the control box.



Warning! Be careful!

Be more careful when this mark appears.

### 1.5.3 Operation Regulations

- 1) Before operation, make sure that cooling water is clean soft water without pollutants.
  - ※ Low quality water brings limescales, which may cause problems.
- 2) If problems of drainage or bad temperature control are noted, please clean solenoid valve and cooling water inlet and outlet.
- 3) Do not move the unit when it is in operation.
- 4) When in need of repairing, wait until oil temperature falls below 30°C.

- 5) Motor overload may be caused by phase shortage, pipe obstruction, broken bearing, etc. Motor overload relay will trip off to stop the machine when this happens. Fixing the problems, press RESET on overload relay to clear the alarm.
- 6) Before turn off the pump, wait until oil temperature falls below 50°C. Or the life of the unit would be affected.
- 7) If the setting temperature is below 100°C, then the pressure switch setting value should be 1.5-2 bar; If the setting temperature sets between 100°C and 200°C, then the recommendable pressure switch setting value should be 2.8 bar. If the cooling water pressure is too low, then the pressure switch setting value can be adjusted properly to ensure normal running. However, it may affect the limitation of setting temperature or cause unstable temperature control.
- 8) Please connect the cooling water outlet with high temperature resistant pipe when temperature is above 100°C.

#### 1.5.4 Transportation and Storage of the Machine

##### Transportation

- 1) STM-PW series standard oil heater are packed in crates or plywood cases with wooden pallet at the bottom, suitable for quick positioning by fork lift.
- 2) After unpacked, castors equipped on the machine can be used for ease of movement.
- 3) Do not rotate the machine and avoid collision with other objects during transportation to prevent improper functioning.
- 4) The structure of the machine is well-balanced, although it should also be handled with care when lifting the machine for fear of falling down.
- 5) The machine and its attached parts can be kept at a temperature from -25°C to +55°C for long distance transportation and for a short distance, it can be transported with temperature under +70°C.

##### Storage

- 1) STM-PW series standard oil heater should be stored indoors with temperature kept from 5°C to 40°C and humidity below 80%.
- 2) Disconnect all power supply and turn off main switch and control switch.

- 3) Keep the whole machine, especially the electrical components away from water to avoid potential troubles caused by the water.
- 4) Plastic film should be used to protect the machine from dust and rains.

### Working environment

The machine should be operated:

- 1) Indoors in a dry environment with maximum temperature +45°C and humidity not more than 80%.

Do not use the machine:

- 1) If it is with a damaged cord.
- 2) On a wet floor or when it is exposed to rain to avoid electrical shock.
- 3) If it has been dropped or damaged until it is checked or fixed by a qualified serviceman.
- 4) This equipment works normally in the environment with altitude within 3000m.
- 5) At least a clearance of 1m surrounding the equipment is required during operation. Keep this equipment away from flammable sources at least two meters.
- 6) Avoid vibration, magnetic disturbance at the operation area.

### Rejected parts disposal

When the equipment has run out its life time and can not be used any more, unplug the power supply and dispose of it properly according to local code.

### Fire Hazard



In case of fire, CO<sub>2</sub> dry powder fire extinguisher should be applied.

Please abide by the safety guide when you operate the machine so as to prevent damage of the machine and personal injuries.



All electrical components should be installed by qualified electricians.  
Turn off main switch and control switch during repair and maintenance.



Warning! High voltage!



This mark is attached on the cover of the control box.



Warning! Be careful!

Be more careful when this mark appears.



Warning!

High temperature, take care of hands! This label is attached on the surface of heating parts.

## 1.6 Exemption Clause

The following statements clarify the responsibilities and regulations born by any buyer or user who purchases products and accessories from Shini (including employees and agents).

Shini is exempted from liability for any costs, fees, claims and losses caused by reasons below:

1. Any careless or man-made installations, operation and maintenances upon machines without referring to the Manual prior to machine using.
2. Any incidents beyond human reasonable controls, which include man-made vicious or deliberate damages or abnormal power, and machine faults caused by irresistible natural disasters including fire, flood, storm and earthquake.
3. Any operational actions that are not authorized by Shini upon machine, including adding or replacing accessories, dismantling, delivering or repairing.
4. Employing consumables or oil media that are not appointed by Shini.

## 2. Structure Characteristics and Working Principle

### 2.1 Main Functions

The STM-MW series of standard water heater are used to heat up the mould and maintain this temperature. Besides, they can also be used in other similar applications. High temperature water from the mould is cooled by direct cooling and then sent to the pipe heater via high-pressure pump for heating to a constant temperature. With our optimised design, water can reach a maximum of 120°C and the HANYOUNG temperature controller can maintain an accuracy of  $\pm 1^{\circ}\text{C}$ .

### 2.2 Working Principle

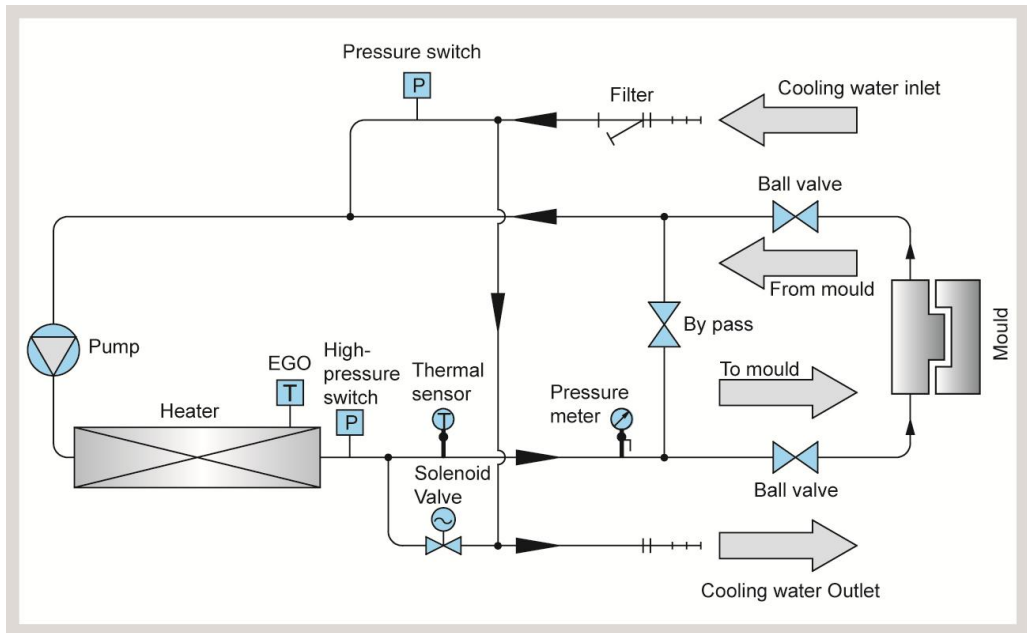

Picture 2-1: Working Principle

High temperature water returns to the machine and then be pressured by pump to the heater. After being heated, water will be forced to mould and continue the circle. In the process, if the water temperature is too high, the system will activate the solenoid valve to let cooling water cool down the temperature directly until the water is down to the system requirement. If the temperature keeps increasing and reach to the set point of EGO, system will sound high pressure alarm and stop operation; when system pressure is too high (Reach

set value of high pressure switch), alarm would sounds and machine halts; if high pressure switch fails to function and system pressure continues to rise to reach set value of safety valve, safety valve would start up to release pressure; when cooling water pressure fails to reach the set value, pressure switch will send a signal of water storage to launch low pressure alarm and machine halts.

### 3. Installation and Debugging

#### 3.1 Installation Space

During installation of the machine, keep at least 500mm installation space around the machine as shown by the picture. Do not install the machine in a position crowded with other objects. This would cause inconvenience to operation, maintenance and repair.

Do not sit on the machine.

Keep away flammable and explosive goods.



Picture 3-1: Installation Space

#### 3.2 Mould and Water Coupling

- 1) It is necessary, while connecting from the access to mould, to use two spanners to fix the switching connection and ball valve before screw tightly the horn nut of the connection pipe, otherwise water might leaks from the machine.

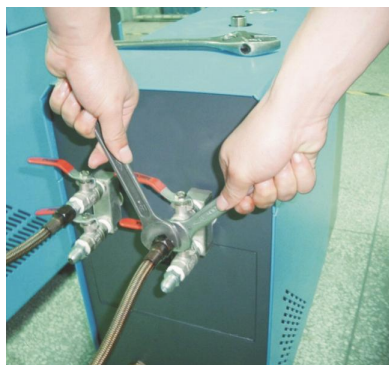

Picture 3-2: Mould and Water Couplings 1

- 2) Unused mould couplings can be connected with each other by a teflon pipe, as shown in.

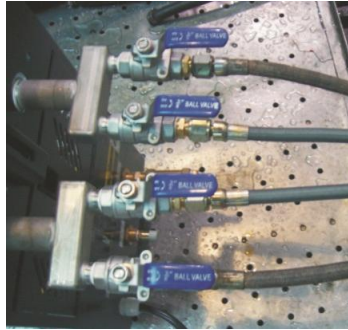

Picture 3-3: Mould and Water Couplings 2

**Note: Cooling water inlet and outlet as shown by the Figure. Please do not connect reversely. Please connect the cooling water outlet with high temperature resistant pipe when temperature is above 100 °C.**



Cooling water outlet  
Cooling water inlet

Picture 3-4: Mould and Water Couplings 3

- 3) Connect cooling water inlet with water supply and cooling water outlet with a drainage pipe. After that, turn on water supply.

### 3.3 Power Supply

Make sure that power supply is the same as required before installation.

Mould heater are generally set to be used with 3Φ400V power supply or other specifications according to customers' requirement.

## 3.4 Options Installation

### 3.4.1 Installation steps for options water manifold (dewaxing)

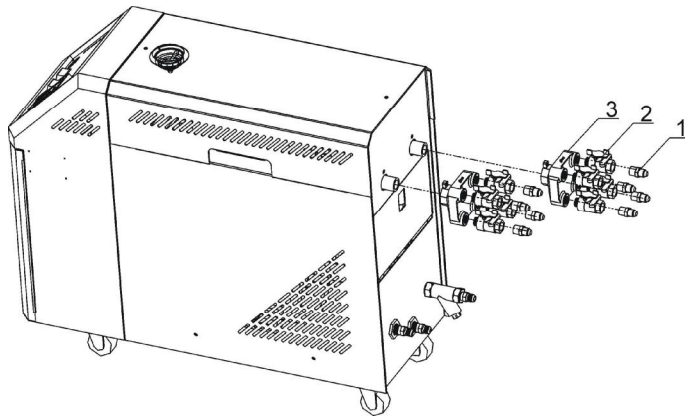

- 1) Install copper joint to the level valve.
- 2) Install level valve with copper joint to the dewaxing water manifold.
- 3) Install water manifold to the machine.
- 4) Install Teflon to copper joint.

**Note: For the operating temperature not higher than 200 °C, Teflon with temperature resistance 200 °C is usable; for the operating temperature from 200 to 300 °C, must use Teflon with temperature resistance 300 °C.**

### 3.4.2 Installation steps for options water manifold (welding)

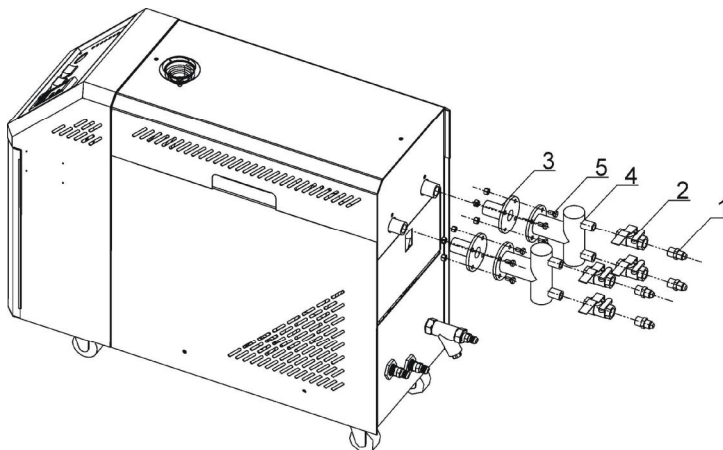

- 1) Install copper joint to the level valve.
- 2) Install level valve with copper joint to the welding water manifold.

- 3) Install water manifold to the machine.
- 4) Connect water manifold with manifold joint via screws.
- 5) Install Teflon to copper joint.

***Note: For the operating temperature not higher than 200 °C, Teflon with temperature resistance 200 °C is usable; for the operating temperature from 200 to 300 °C, must use Teflon with temperature resistance 300 °C.***

## 4. Operation Guide

### 4.1 Control Panel

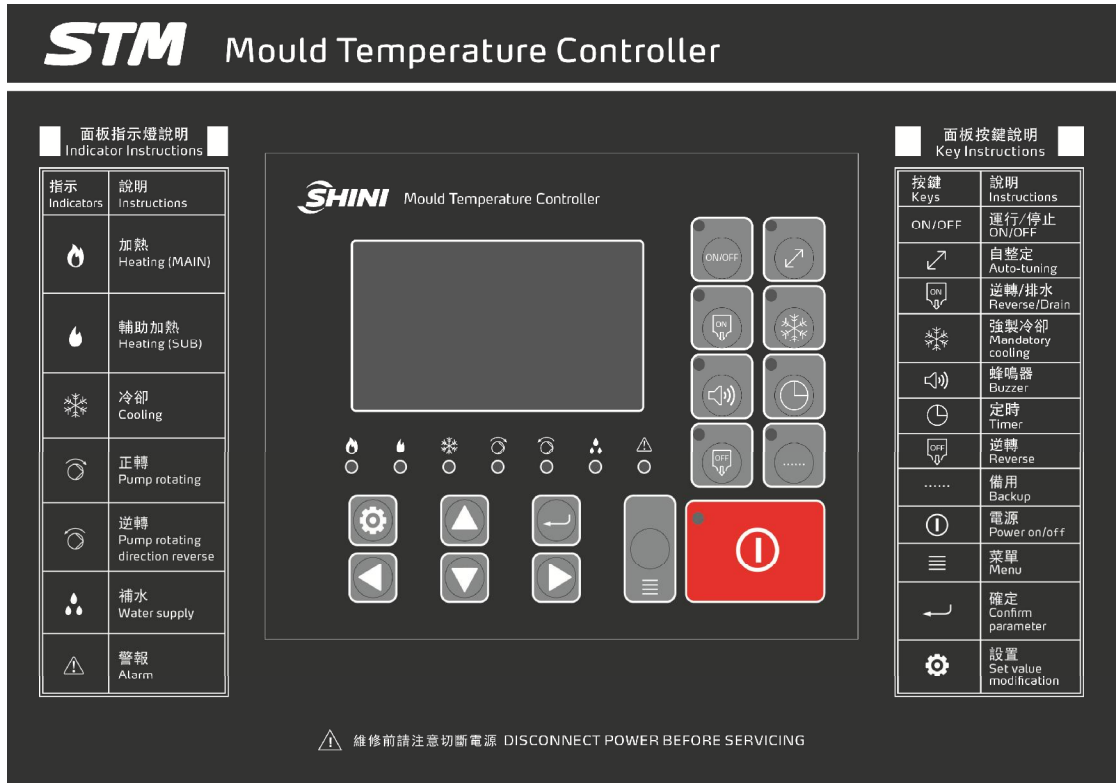

Picture 4-1: Control Panel

Table 4-1: Control Panel

No.	Name	Functions	Remarks
	Heating(Main)	Heating output indicator	-
	Heating(SUB)	Auxiliary heating output indicator	-
	Cooling	Cooling indicator	-
	Pump rotating	Display pump positive action indicator	-
	Pump rotating direction reverse	Pump reverse action indicator	-
	Water supply	Water refilling indicator	-
	Alarm	Send alarm indicator	Refer to table 4-2 for errors instruction.
ON/OFF	ON/OFF	Run/stop key	-

















No.	Name	Functions	Remarks
	Auto-tuning	Auto tuning key	-
	Reverse/Drain	Reverse running/dischage	-
	Mandatory cooling	Forced cooling key	Hold the button for 2 secs to enable force cooling. It stop heating while enable 100% cooling. It stops after the temperutre drops below Cooling Temp.
	Buzzer	Buzzer off switch	After press" BUZZER" button, " BUZZER" LED on, Buzzer and alarm relay in idle mode even error occurs.
	Timer	Reserved timing key	-
	Reverse	Reverse key	-
.....	Backup	Backup key	-
	Power ON/OFF	Power on/off key	-
	Menu	Menu key	Parameter confirmation
	Confirm parameter	Confirm key	-
	Set valve modification	Setting key	-
	-	Up key	-
	-	Down key	-
	-	Left key	-
	-	Right key	-

Table 4-2: Error Type

Error display	Cause of Error	Alarm	Temp. control
Board error	Regulator error	Activated	Stop
Calib error		Activated	Stop
Adc error		Activated	Stop
Rjc error		Activated	Stop
Eeprom error		Activated	Maintain its status
Phase error	Default phase or phase reverse	Activated	Stop
EGO Over temp.	Check input EGO temp.	Activated	Stop
Pump overload	Check input pump overload	Activated	Stop
Low pressure	Check low pressure input	Activated	Stop
High pressure	Check high pressure input	Activated	Stop
Low water level	Check low water level input	Activated	Stop
Appear "-----" on temperature display	Sensor abnormality	Activated	Stop
Water outlet temp. deviation	Control temp. and water return outlet temp. deviation	Activated	Maintain its status
Return water temp. deviation	Water outlet temp. and return water temp. deviation	Activated	Maintain its status
Turb. alarm	Process temperature (PV) drops rapidly.	Activated	Maintain its status
Heater alarm	Set temperature (SV) on but process temperature (PV) remains idle.	Activated	Maintain its status
Overheat	Over temp. alarm	Activated	Stop

Notes: When alarm sounds, controller will automatically stops the equipment. Press "RUN" to restart the machine.

## 4.2 Menu Introduction

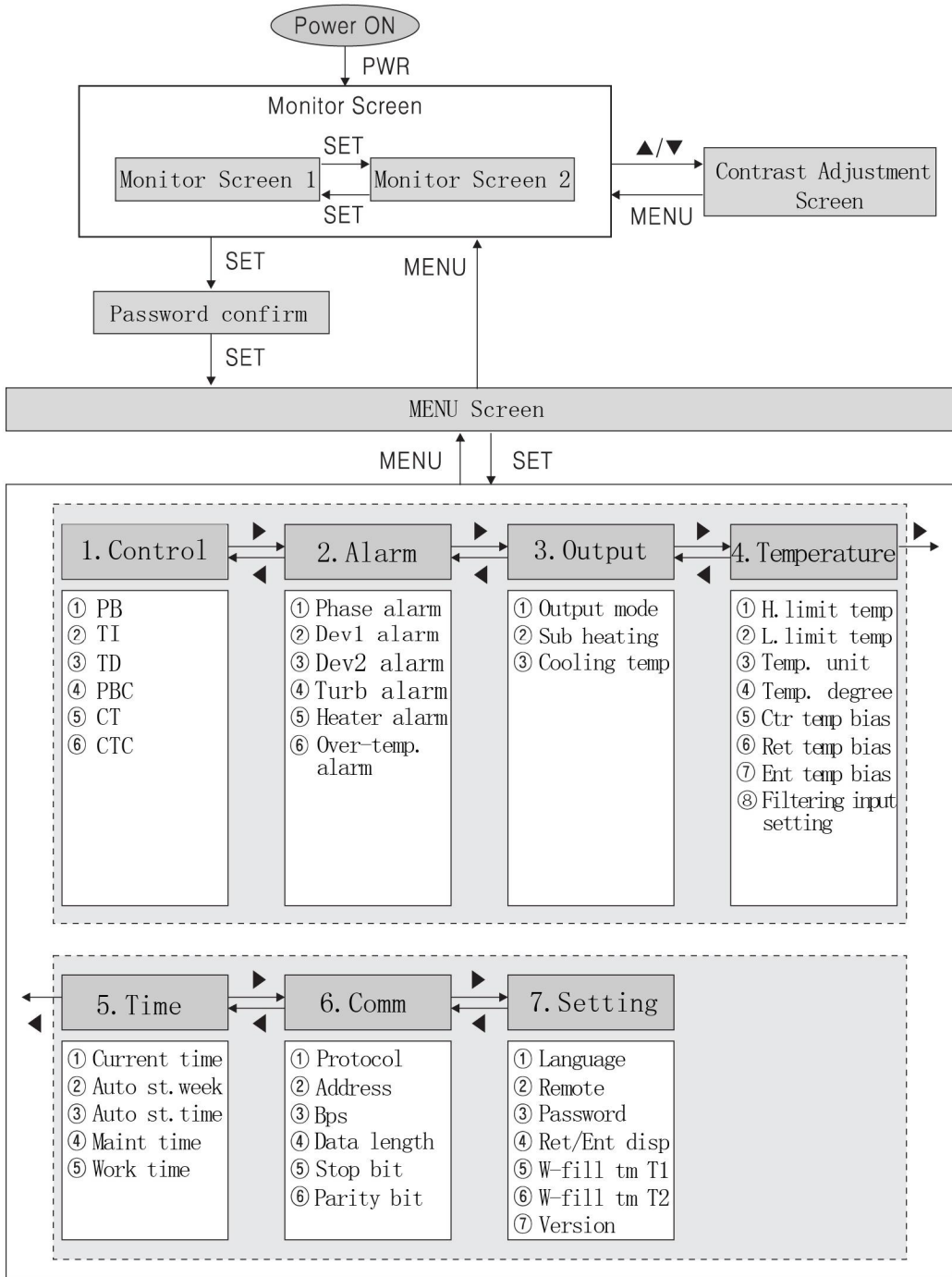

Pictute 4-2: Menu Outline

### 4.3 Machine Startup

- 1) Connect hose from STM water/oil in/outlet to the mold. (Refer to chapter 3.2 for hose connection)
- 2) Connect water to cooling/water input (Refer to chapter 3.2 for hose connection)
- 3) Open all the ball valves.
- 4) Switch on main power.

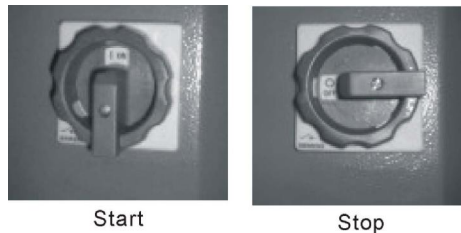

Picture 4-3: Main Power Switch

- 5) Press ON/OFF POWER button of the controller to enter initial screen.

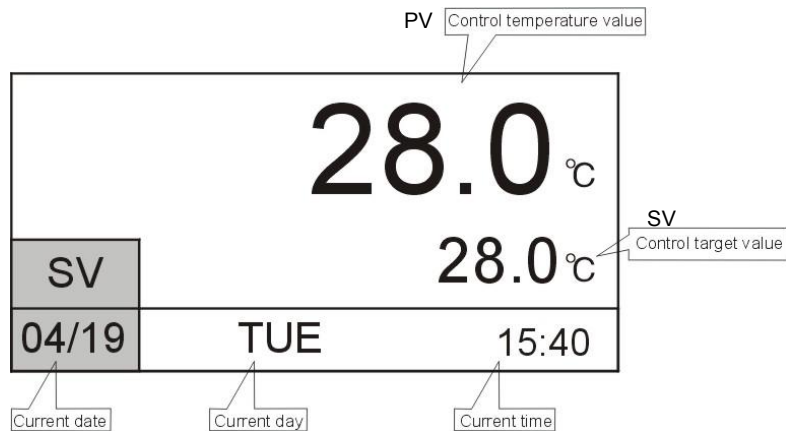

Picture 4-4: Initial Menu

- 6) Press MENU key to enter menu selection screen, press ◀/▶ keys to control setting menu, press SET key to enter setting screen, see picture below.

**Note: The parameters derived based on AT auto-tuning. Please do not change it with no special circumstance.**

## 1. Control Menu

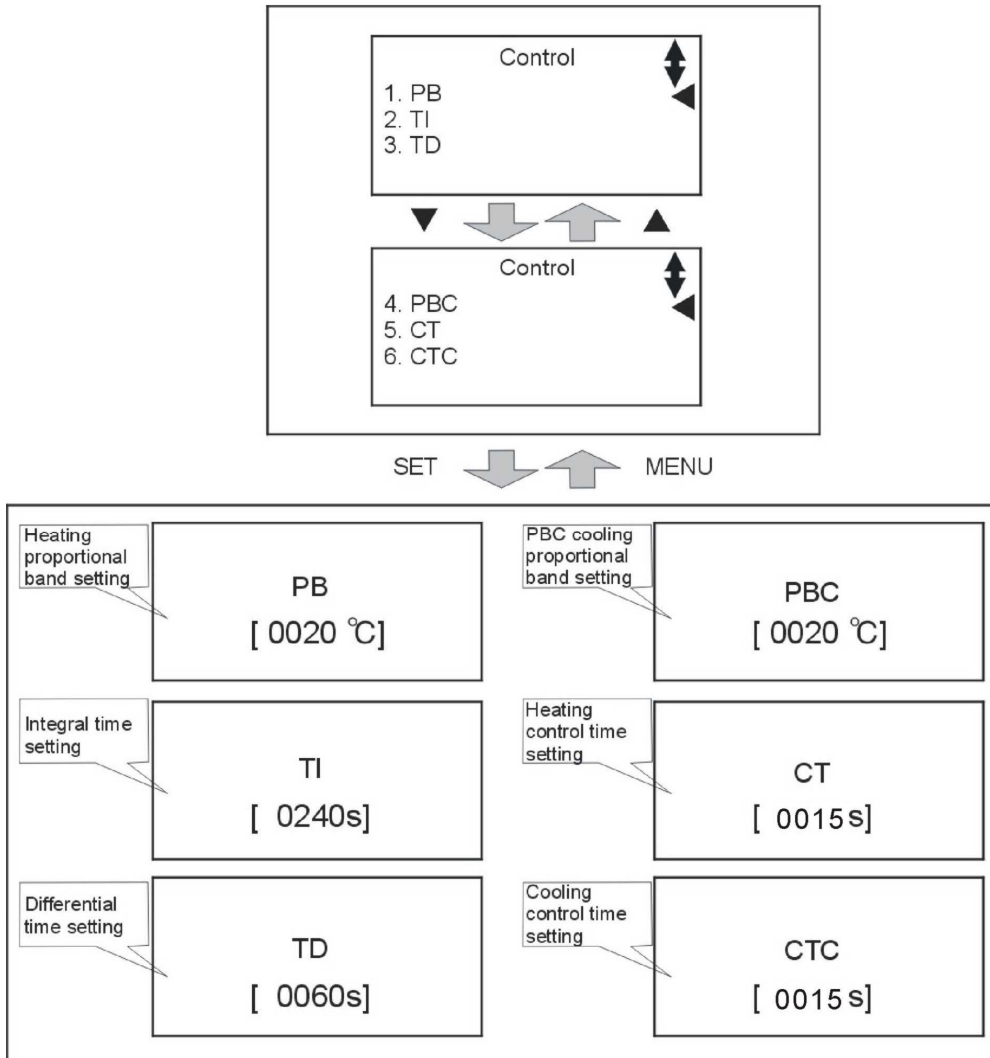

Picture 4-5: Control Setting Screen

## 2. Alarm Menu

Press MENU key to return menu selection screen, press ◀/▶ keys to temp. setting menu, press SET key to enter setting screen, as picture. All parameters are as below:

Default parameters

PHASE Detection—Activate(prevent water pump reverse due to phase error)

DEV1 ALARM—0 (without temp. sensor)

DEV2 ALARM—0 (without temp. sensor)

TURB ALARM— $0^{\circ}\text{C}/\text{sec}$ . (monitor temp. variation, it alarms when control temp. drops rapidly)

HEATER ALARM—activate when control temp. doesn't rise up. If default value is  $0/\text{sec}$ ., the function is disabled.

Overheat—exceed permissible upper limit temp.  $n^{\circ}\text{C}$ , machine alarms and excitation release enables power off (  $n$  is set value, the default is  $20^{\circ}\text{C}$ ).

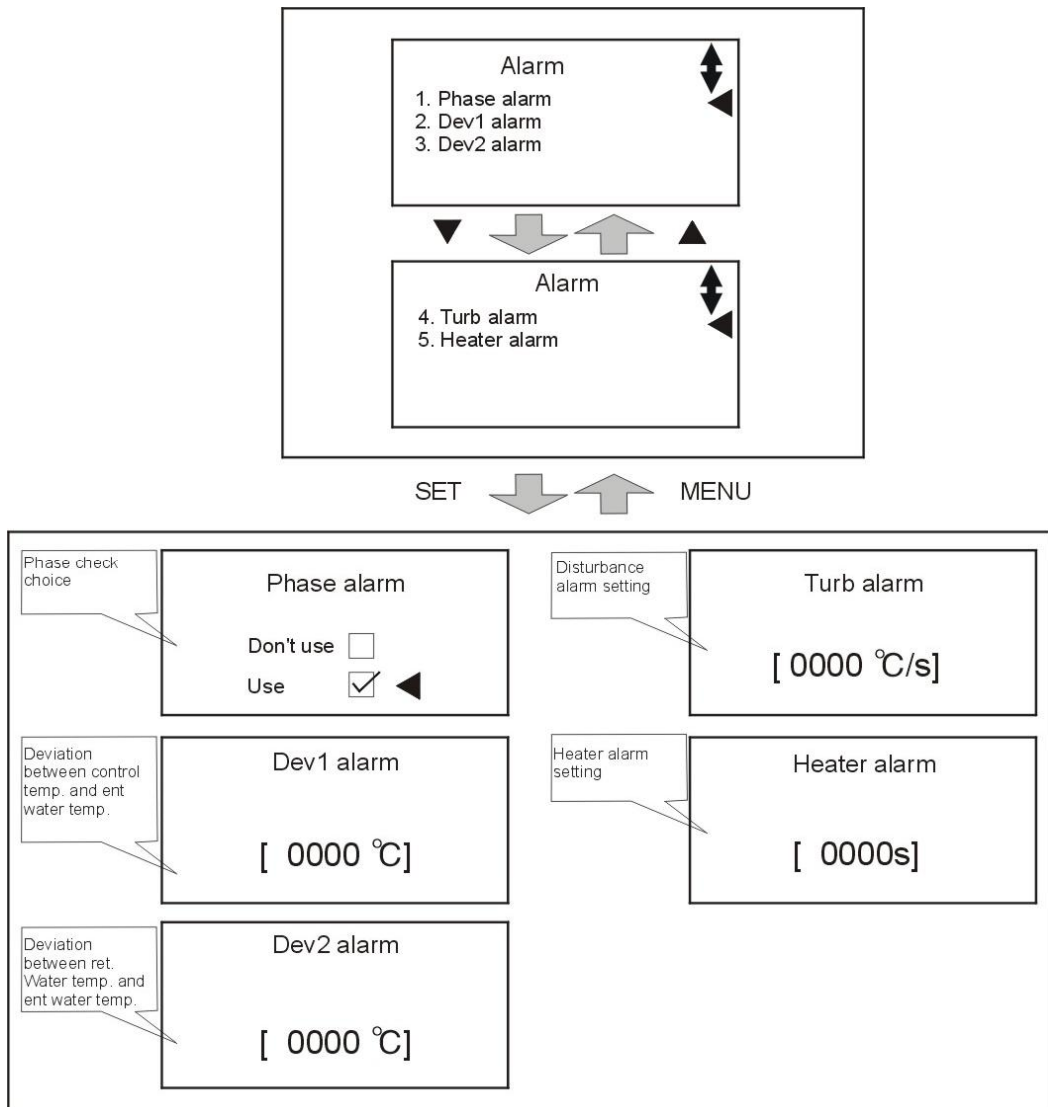

Picture 4-6: Alarm Setting Screen

### 3. Output Menu

OUTPUT MODE— heating control or heating and cooling control ( Default is heating and cooling control)

SUB HEATING— temp. difference of activating sub. heating output (SUB) function. When actual temp. is less than ( set temp. – temp. difference), main heating output and sub. heating output share a same output; when actual temp. is higher than (set temp. –temp. difference), main heating output and sub. heating output only has one group of output ( Note: output relay alternatively output to prolong lifespan).

0°C ( (SUB) function is forbidden, only 1 group of heater)

5°C (two or more groups of heaters)

COOLING TEMP.— Force cooling setting temperature. Default is 35°C (machine halts if temp. drops to set value).

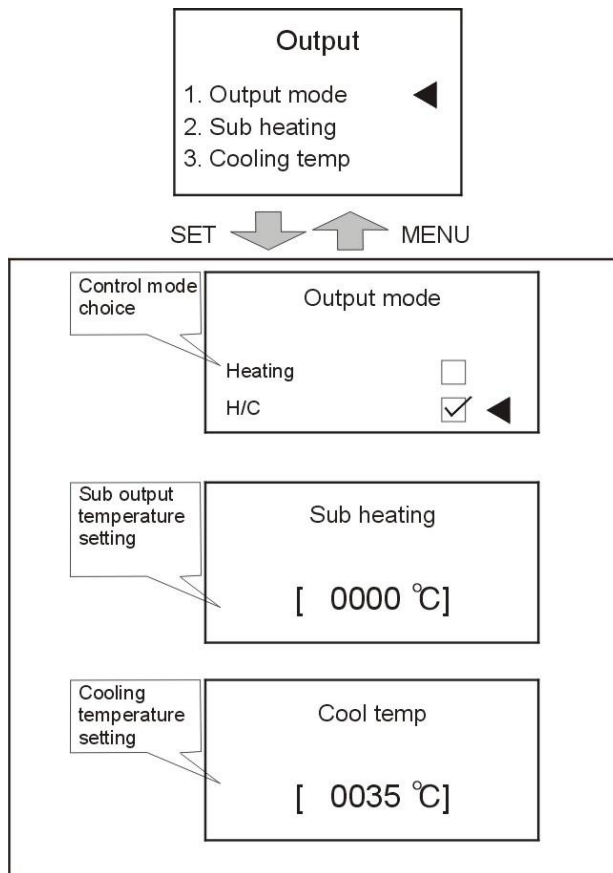

Picture 4-7: Output Setting Screen

#### 4. Temperature Setting Menu

Press MENU key to return menu selection screen, press ◀/▶ keys to temp. setting menu, press SET key to enter setting screen, as picture. All parameters are as below:

UPPER LIMIT TEMP.—Software limit on maximum temperature (each model default is as below)

(STM-O: 200, STM-O-HT: 260, STM-607E:150(max.value is 200), STM-W/STM-WF/STM-WE: 120, STM-PW: 160, STM-HPW: 180, STM-W/O: Water 95 Oil 160).

LOWER LIMIT TEMP.—Software limit on minimum temperature. Default: 0. (Note: The equipment use external cooling water to cool. Cooling temperature can't below cooling water temperature.)

TEMP. UNIT—Unit in °C/°F (Celsius and Fahrenheit)

TEMP. DEGREE—Temperature display in 1°C/°F or 0.1°C/°F. Default: 1

CTR TEMP BIAS—Bias correction of control water/oil temperature (Default is 0°C, modification is not recommended.)

RET TEMP BIAS—Bias correction of return water/oil temperature. (Default is 0°C, modification is not recommended.)

ENT TEMP BIAS—Bias correction of process water/oil temperature (Default is 0°C, modification is not recommended.)

Input filtersetting—average temperature during sampling process (Default is 0°C, modification is not recommended.)



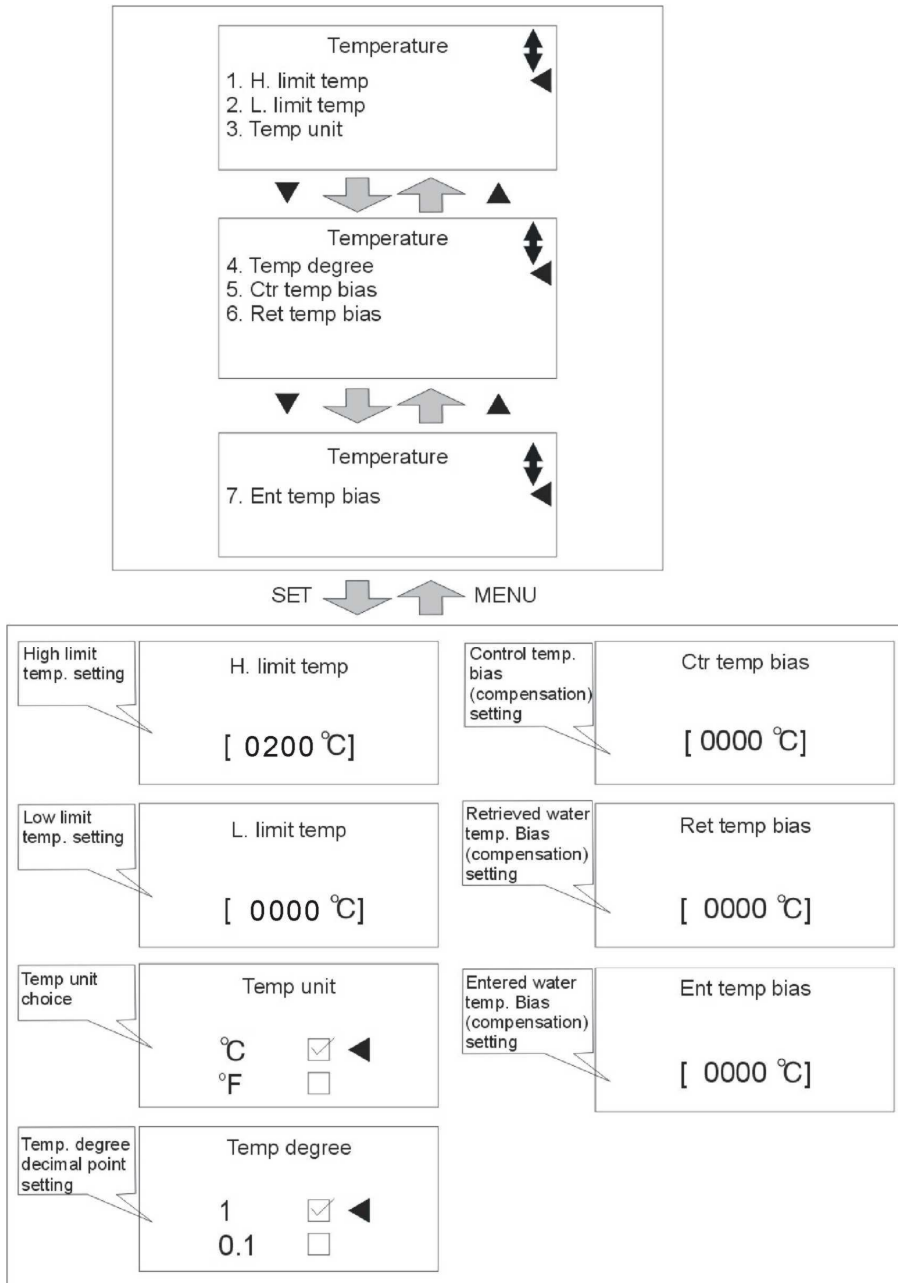

Picture 4-8: Temperature Setting Screen

## 5. Time Setting Menu

Press MENU key to return menu selection screen, press ◀/▶ keys to time setting menu, press SET key to enter setting screen, as picture. The time has been adjusted before delivery. All the reserve time can be set according to actual production demands.

Current time——Format in YYMMDD

Reserv week——Weekly auto start/stop days

Reserv time——Auto start/ stop hour and minutes of the day. Format: xxHour xxMinutes

Maint. time—— Machine maintenance time

Work time —— Machine working hours

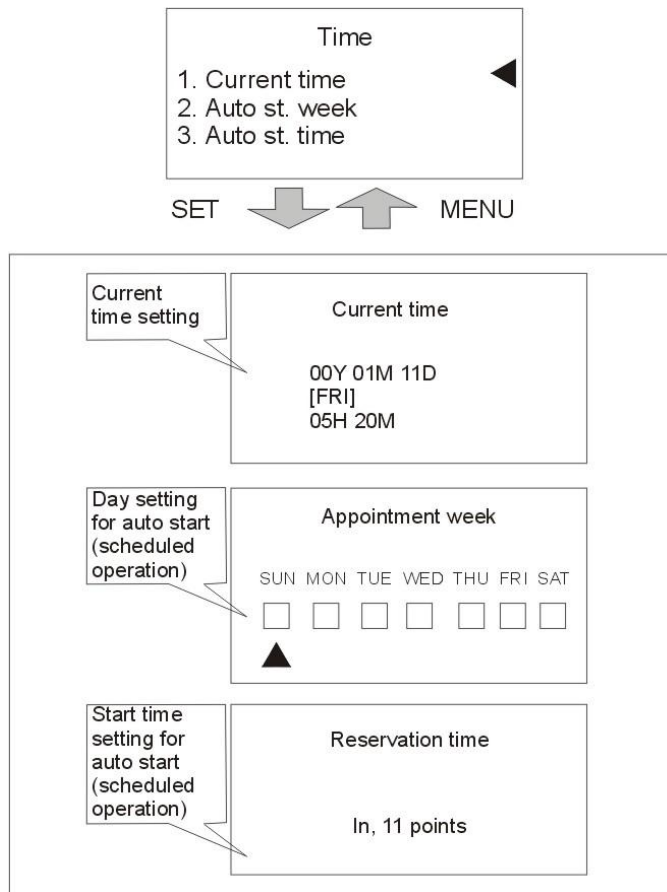

Picture 4-9: Time Setting Screen

## 6. Communication Setting Menu

Reserve used for RS485 communication protocol.

Press MENU key to return menu selection screen, press ◀/▶ keys to communication setting menu, press SET key to enter setting screen, as picture.

When optional with communication function, set the parameters according to the requirements.

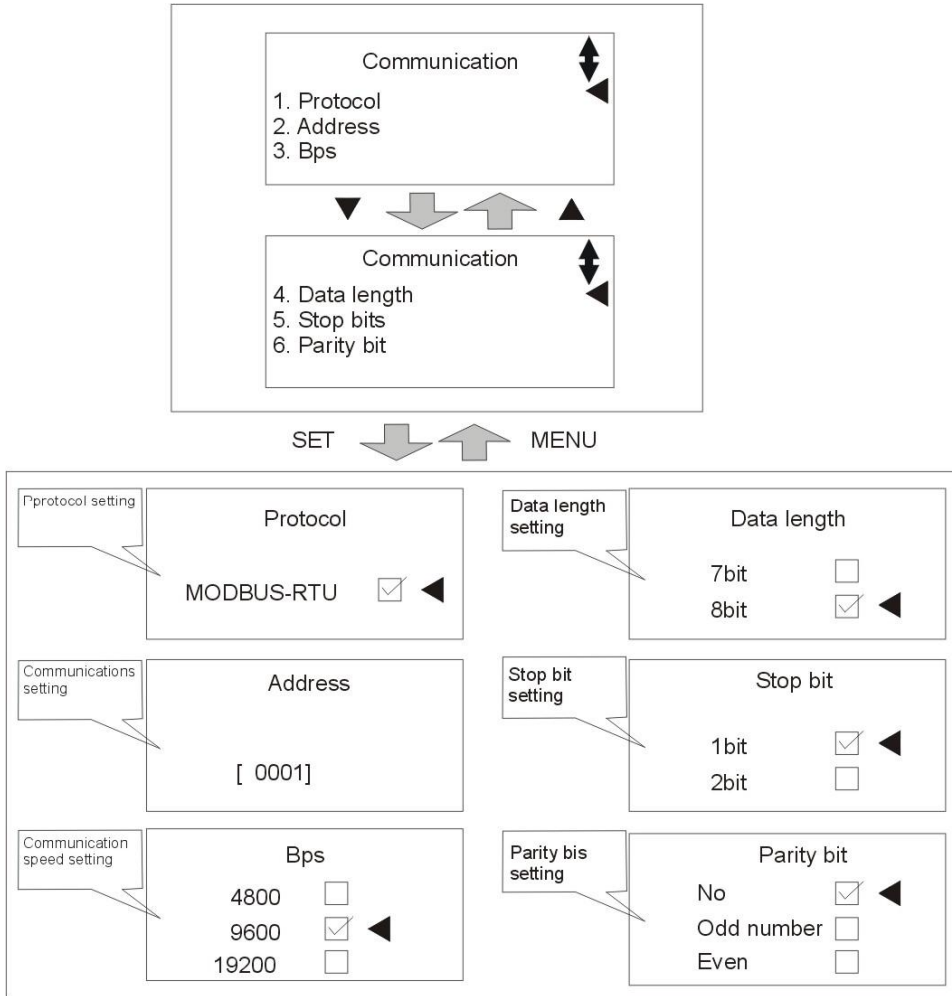

Picture 4-10: Communication Setting Screen

## 7. Setting Menu

Press MENU key to return menu selection screen, press ◀/▶ keys to machine setting menu, press SET key to enter setting screen, as picture. The parameters are set before delivery, and all the parameters can be adjusted according to actual demands.

Language——English and Chinese.

Remote control: Default Unused (Special notes: this remote control uses 1-5 VDC to set control temp. value, which is unrelated with communication function. When remote control is activated, temp. set value can't be adjusted on the control panel.)

Password: Default 0000.

Ret/Ent Disp: Return and process water/oil temperature display. Default: Disable.

W-fill tm t1: Start delay for water unit to refill water in seconds. Automatically enable after disable the breaker. Default 1 for oil unit, water unit as below table.

W-fill tm t2: Interval delay for water unit to refill water in seconds. Automatically enable after disable the breaker. Default 0 for oil unit, water unit as below table.

Table 4-3: Water-filling Time of Each Water Unit

Model	STM-607W/W-D/PW /PW-D/HPW/WF STM-910W/W-D/WF	STM-1220W/PW/WF /STM-1213HPW/STM-2440W /STM-2430WF	STM-3650W /STM-3650WF /STM-4875WF
t1	60S	120S	180S
t2	10S	15S	20S

Specific instructions are as follows:

W-fill tm T1=0: press RUN key to start water refilling, when reaches the high water level it starts the pump and heating.

W-fill tm T1 ≠ 0: press RUN key to start water refilling t1, then pump starts, delay for W-fill tm t2, it starts heating ( the water-filling process is as below picture).

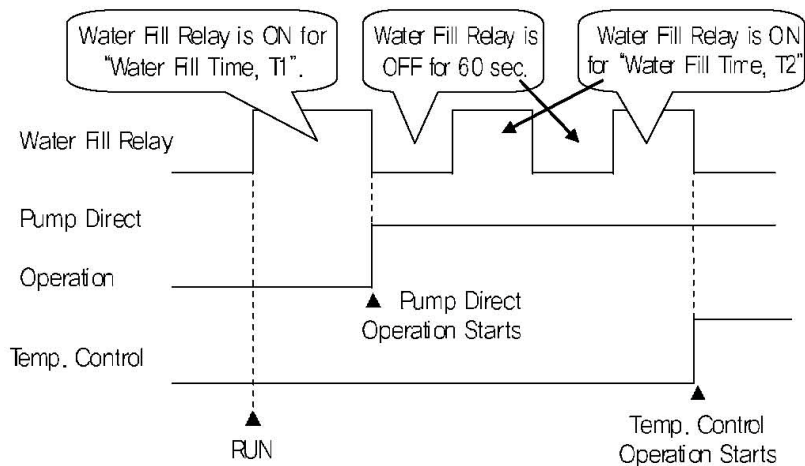

(Water filling function in water filling time)

Version: version of control program.

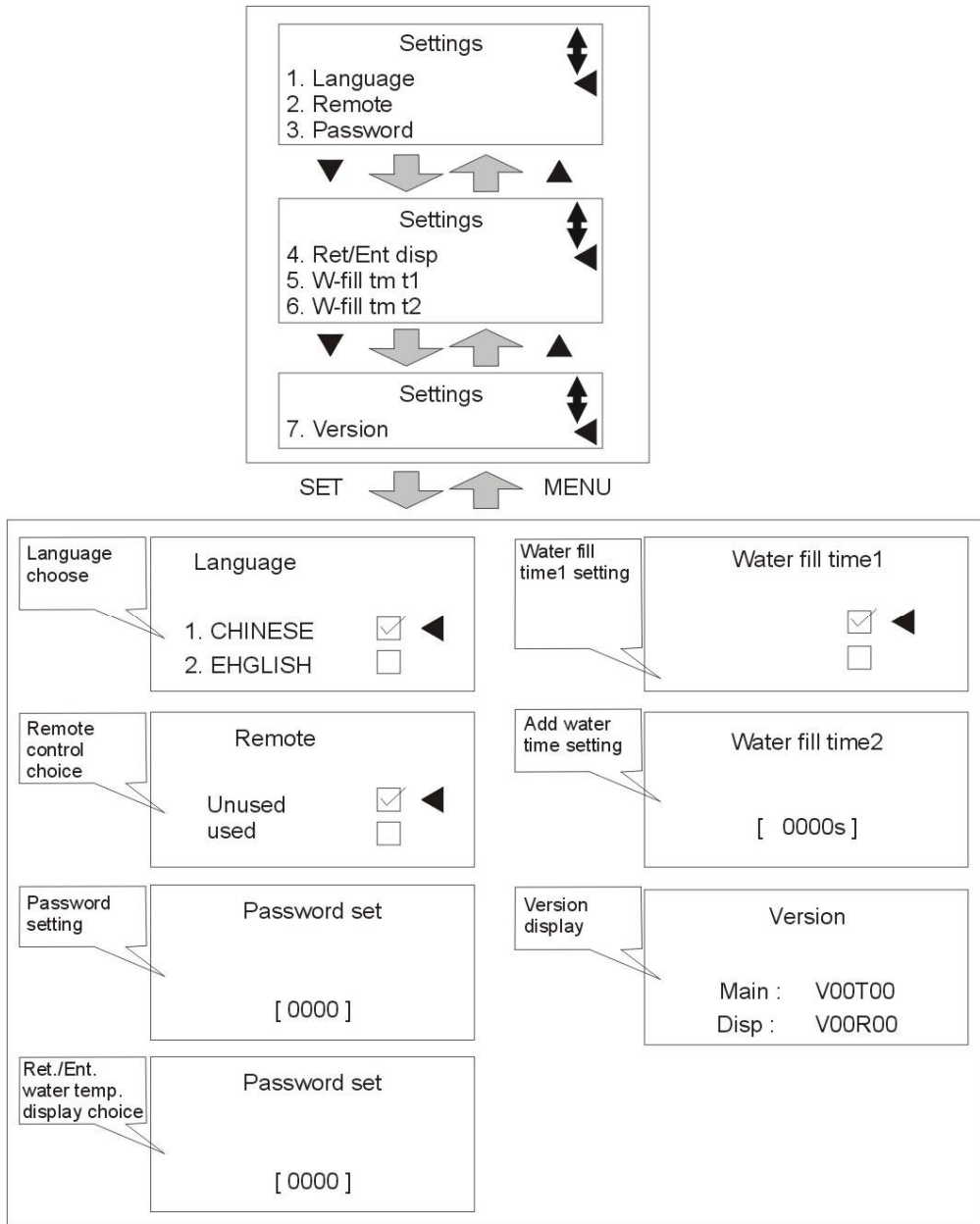

Picture 4-11: Machine Setting Screen

## 8. Input Heating Temperature

- 1) Set mold temperature (if temp. has been set, this step can be ignored). Press SV key and SV column will be flashing, press ◀/▶ key to move cursor then press ▲/▼ key to change values. Finally press SET key to confirm them.
- 2) After setting the SV, press RUN/RESET key to begin temperature control, Auto-tuning is needed if deviation of temperature is large. Press AT key and LED light begins flashing to start Auto-tuning. When flashing ends, Auto-tuning finishes and parameters will be automatically saved. During Auto-tuning, pressing AT key will exit Auto-tuning process; controller will conduct temperature control based on existing parameters before the Auto-tuning.

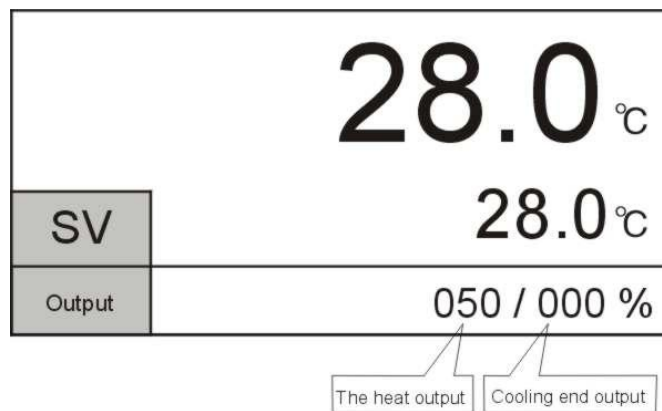

Picture 4-12: Operation Screen

## 4.4 Stop the Machine

- 1) Press COOL key to shut down heating output, and cooling works 100%.
- 2) Wait until temperature drops to below 50 °C, press COOL key to shut down forced cooling, then press RUN/RESET key to stop operation.
- 3) Switch off the main power.

### Caution



Warning!

While the main switch is on, caution of electrical shock.



Note!

Pump motor rotating direction should be the same with the indicator.



Note!

Please do follow the above steps to turn on and off the machine. Fail to do so will reduce the lifespan of equipment.

## 5. Trouble-shooting

Failures	Possible reasons	Solutions
LCD displays nothing after switch on power and press ON/OFF key.	Did not connect through power supply. Main switch broken. Power supply wires problems. Control circuit fuse melt. Transformer broken.	Connect through power supply. Replace main switch. Check electrical wires. Fix the fuse. Replace the transformer.
Phase alarm.	Power supply low voltage. Phase shortage. Phase reversal. PCB problems.	Check power supply. Check power supply. Exchange two of the wires of power supply. Replace the PCB.
Pump overload.	Abnormal fluctuations of power supply. Pump blocked. Pump motor problems. Overload relay (F1) setting value error.	Check power supply. Check the pump. Check pump motor. Set the setting current of overload relay to equal to 1.1 times of motor rated current. Please refer to Mian Components for detailed description of overload relay. Reset overload relay: Wait for one minute, then press the blue button to reset.
EGO overheat.	EGO temperature setting mistakes. EGO poor temperature detecting. Heater contactor K1 and K2 problems.	Correctly set EGO temperature. (EGO temperature setting value= temperature setting value+10℃) Replace EGO. Replace the contactor.
Low liquid level.	Oil shortage.0	Fill high temp. oil.
Temp. window displays “----“	Abnormal sensor.	Check and repair sensor.
Once running, pump output indicator lightens but pump cannot start. Afetr a while pump still fails to run.	PCB output relay problems. Electrical circuit problems.	Check or replace the PCB. Check electrical circuit.
Differences between setting temperature and actual temperature is too big.	Too short time after machine startup. Temperature parameter setting error. Cooling water valve problems.	Wait for a while. Check temperature parameters. Please refer to the standard manual of setting parameters. Replace solenoid valve.
Temperature can't rise up.	Heater contactor problems. Heater problems. Thermocouple problems. PCB output point problems.	Replace the contactor. Replace pipe heater. Replace thermocouple. Check and repair PCB.



<b>Failures</b>	<b>Possible reasons</b>	<b>Solutions</b>
Circuit breaker tripping off at turning on main switch.	Short circuit of main circuit. Transformer short circuit or connected with earth wire. Problems of circuit breaker.	Check electrical wire. Replace circuit breaker.
Circuit breaker tripping off at turning on pump switch.	Pump motor coil short circuit. Problems of circuit breaker.	Check pump motor. Replace circuit breaker.
Circuit breaker tripping off after short heater output.	Heater tube short circuit or shell contact. Problems of circuit breaker.	Replace heater tube. Replace circuit breaker.

## 6. Maintenance and Repair

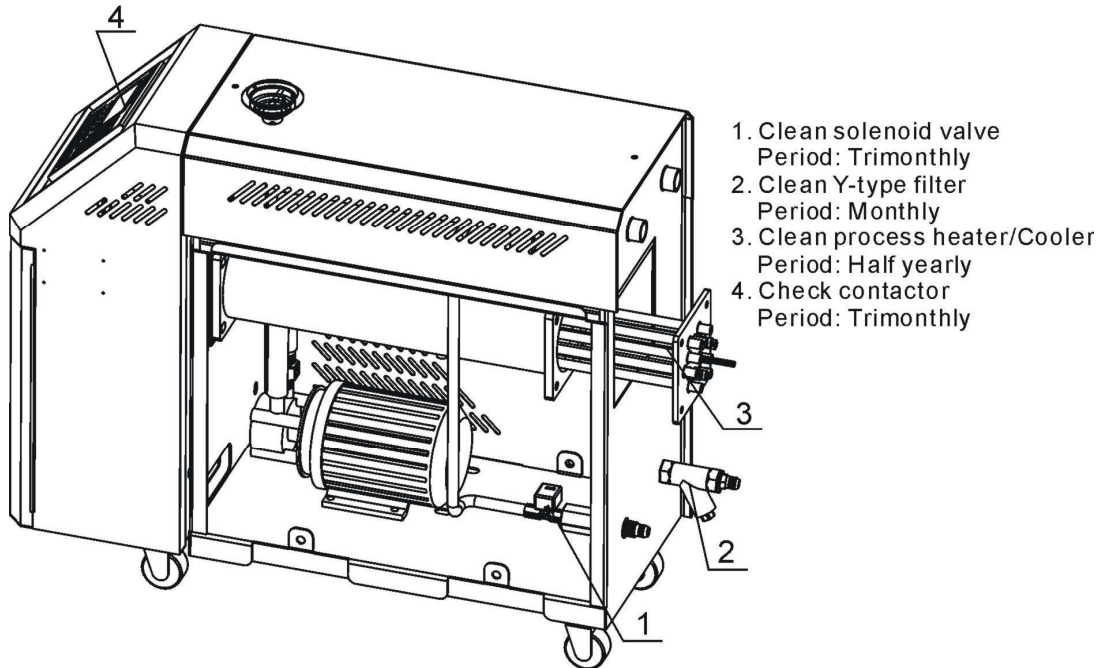

Pay attention to the following rules during maintenance:

- 1) Please reduce the temperature to room temperature (below 50°C), cut off power supply and drain oil and water first while inspecting the machine; carry out operations with safety gloves on after complete confirmation of spaces for inspection and maintenance.
- 2) It is necessary to carry out periodic inspections in order to prolong service life of the system and prevent from safety accidents.

(Please note that it is dangerous to check or tear down the machine during operation.)

## 6.1 Open the Covers

- 1) Open the top covers of the unit. (Refer to the pictures below)



Picture 6-1: Open the Covers 1

- 2) Take down the side covers. (Refer to the pictures below)



Picture 6-2: Open the Covers 2

- 3) Open the cover of control box. Screw off two butterfly screws to unlock the cover. (Refer to the pictures below)



Picture 6-3: Open the Covers 3

## 6.2 Y Type Strainer

- 1) Clean soft water should be used as cooling water. Filter screen is used in the strainer to stop impurities and pollutants to enter into water pipe.
- 2) Impurities or pollutants may cause errors and bad temperature control. Clean filter screen of the strainer periodically.
- 3) Cleaning steps: turn off power and cooling water supply. Open the top cover of filter screen to clean the filter.

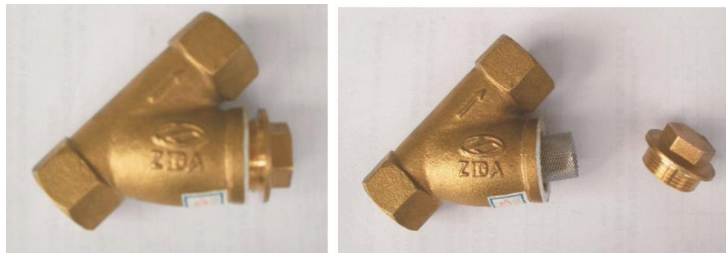

Picture 6-4: Y Type Strainer

## 6.3 Solenoid Valve

Replace solenoid valve:

- 1) Open machine top cover.
- 2) Take down right side cover.
- 3) Unfix the solenoid valve for replacement.
- 4) Install the covers in a reverse order.



Solenoid valve

Picture 6-5: Solenoid Valve

## 6.4 Pipe Heater

- 1) Open machine rear cover door. (Refer to pictures below)

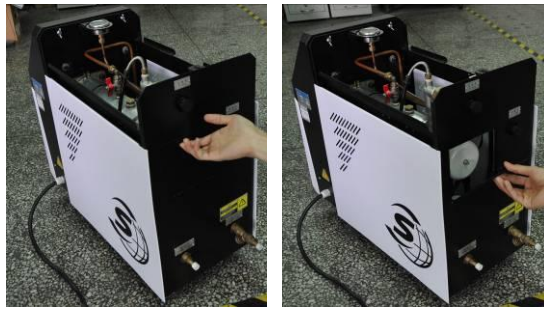

Picture 6-6: Pipe Heater 1

- 2) Unlock heater cap. (Refer to pictures below)



Picture 6-7: Pipe Heater 2

- 3) Unlock the screws of pipe heater to take it out. (Refer to the pictures below.)

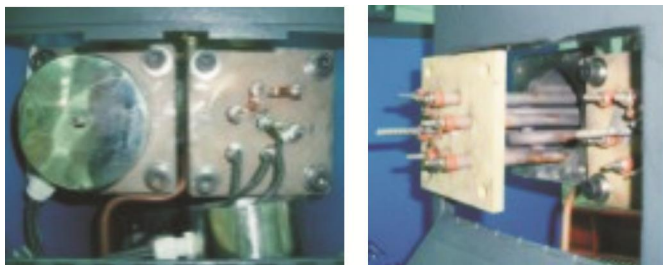

Picture 6-8: Pipe Heater 3

- 4) Install the pipe heater in a reverse order.

## 6.5 By-pass Globe Valve

Shut off the by-pass globe valve when water pressure gauge display value is too low.



Picture 6-9: By-pass Globe Valve

## 6.6 Printed Circuit Board

MAIN terminal board drawing (refer to next page for terminal position and number).

### ① SENSOR TERMINAL1 (sensor terminal)

2, 3 : control temp. sensor terminal

5, 6 : return water temp. sensor terminal

8, 9 : water out temp. sensor terminal

11, 12 : 1~5V input terminal

### ② DI TERMINAL (contactor input terminal)

13, 14 : pump overload contactor input terminal

15, 16 : EGO overheat contactor input terminal

17, 18 : underpressure contactor input terminal

19, 20 : overpressure contactor input terminal

21, 22 : lower water limit contactor input terminal

23, 24 : upper water limit contactor input terminal

### ③ OUTPUT TERMINAL (output terminal for controlling)

1, 2 : heating control output MAIN (RELAY output)

3, 4 : heating control output SUB (RELAY output)

5, 6 : cooling control output (RELAY output)

④ DO TERMINAL (relay contactor output terminal)

- 1, 2 : pump running contactor output terminal
- 3, 4 : pump inverse running contactor output terminal
- 5, 6 : backup water contactor output terminal
- 7, 8 : SUCTION contactor output terminal
- 9, 10 : alarm contactor output terminal
- 11, 12 : relay contactor output terminal
- 13, 14 : reserve

⑤ PHASE CHECK TERMINAL (phase detect terminal)

- 1 : R phase connect terminal
- 2 : S phase connect terminal
- 3 : T phase connect terminal

⑥ DISPLAY CN (connect terminal for display)

Connect stub cable with STM100.

⑦ POWER TERMINAL (power supply terminal)

- 1 : FG terminal
- 2, 3 : power supply terminal (100~240VAC)

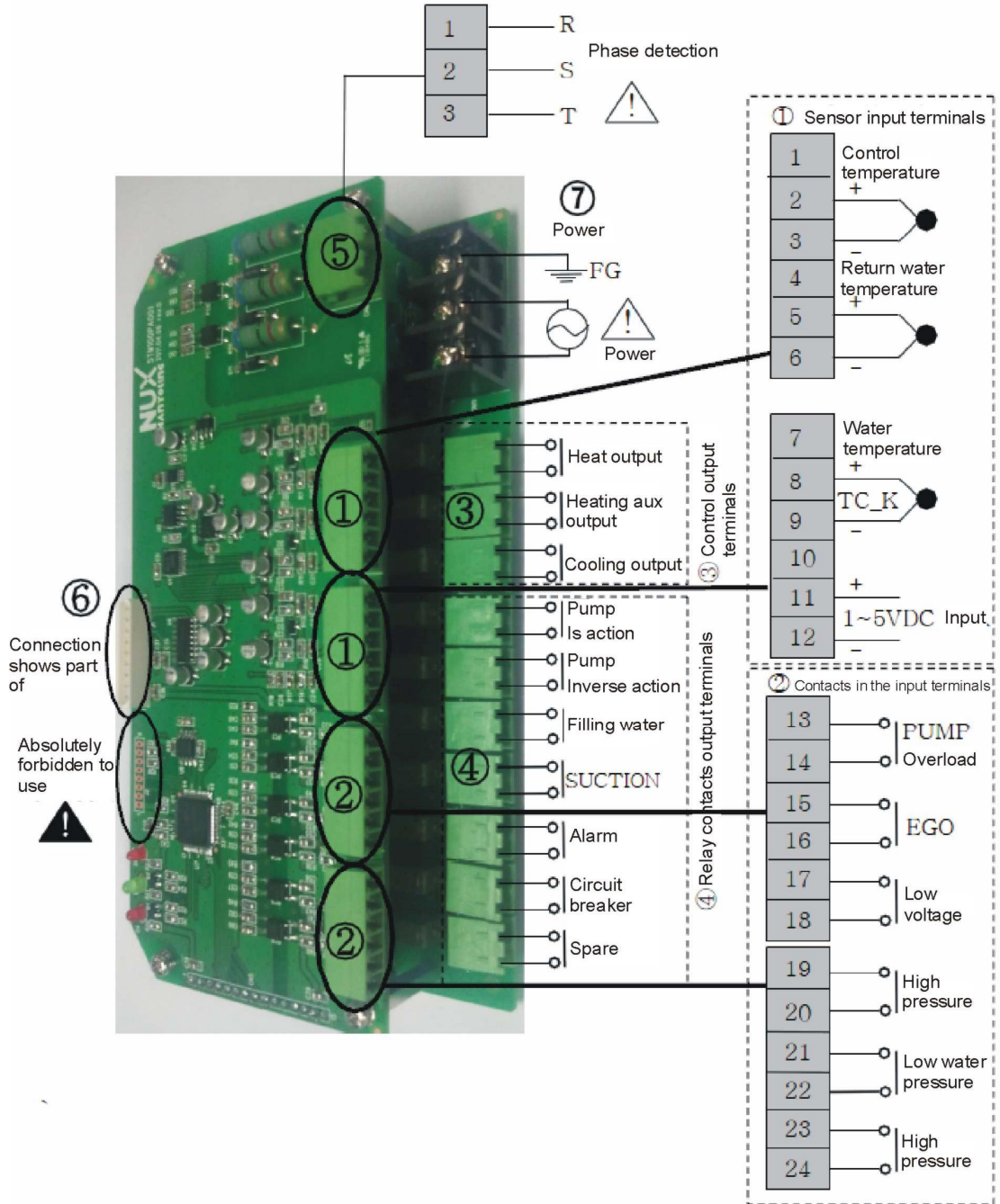



## 6.7 Maintenance Schedule

### 6.7.1 About the Machine

Model \_\_\_\_\_ SN \_\_\_\_\_ Manufacture date \_\_\_\_\_

Voltage \_\_\_\_\_  $\Phi$  \_\_\_\_\_ V Frequency \_\_\_\_\_ Hz Power \_\_\_\_\_ kW

### 6.7.2 Installation & Inspection

- Check the installation space is enough as required.
- Check the pipes are correctly connected.

#### Electrical installation

- Voltage: \_\_\_\_\_ V \_\_\_\_\_ Hz
- Fuse melting current: 1 Phase \_\_\_\_\_ A    3 Phase \_\_\_\_\_ A
- Check phase sequence of power supply.

### 6.7.3 Daily Checking

- Check machine startup function.
- Check all the electrical wires.

### 6.7.4 Weekly Checking

- Check loose electrical connections.
- Check and clean Y type filter <sup>1</sup>.
- Check solenoid valve.
- Check motor overload and phase reversal alarm function.
- Check whether pipeline joints are under looseness.
- Check the sensitivity of EGO.

### 6.7.5 Trimonthly Checking

- Check level switch.
- Check the contactor <sup>2</sup>.
- Replace the hot kerosene with a using temperature above 160 degree <sup>3</sup>.

### 6.7.6 Half-yearly Checking

- Check damaged pipes.
- Clean process heater/cooler.
- Check indicator and buzzer.

- Replace the hot kerosene with a using temperature above 120~160 degree <sup>4</sup>.

#### 6.7.7 Yearly Checking

- Replace the hot kerosene with a using temperature above 120 degree <sup>5</sup>.

#### 6.7.8 3 year Checking

- PC board renewal.
- No fuse breaker renewal.

- Note: 1. Y-type filter has the function of filling water cooling protection effect, be sure the waterway are clear to avoid cooling failure.
2. Manufacturer laboratory data for AC contactor is two million times in life. we suggest service life for one million four hundred thousand times, if work eight hours per day, recommended replacing frequency is 1.5 years, if work day and night, replacement is suggested to be done every six months.
3. Hot kerosene coke will influence the detection accuracy of internal temperature probe and the efficiency of heat elements, three months replacing frequency is suggested.
4. Hot kerosene coke will influence the detection accuracy of internal temperature probe and the efficiency of heat elements, six months replacing frequency is suggested.
5. Hot kerosene coke will influence the detection accuracy of internal temperature probe and the efficiency of heat elements, suggested replacing frequency is one year.