

ST2

Two Axes Servo Driven Robot Keypad Hand Controller User Manual

Date: September, 2015

Version: V1.1 (English)



Contents

1. Transportation and Storage	9
1.1 Transportation.....	9
1.2 Transportation after Unpacking.....	10
1.2.1 Storage.....	11
1.2.2 Operation Environment.....	11
1.2.3 Retirement.....	12
1.3 Exemption Clause.....	12
2. Installation	13
2.1 Instruction.....	13
2.1.1 Safety Issue.....	13
2.1.2 Compressed Air Connection.....	13
2.1.3 Electric Power Connection.....	13
2.1.4 Safety Fence.....	14
2.1.5 Mounting Preparation.....	14
2.1.6 Mounting Instruction.....	14
2.2 Equipment Specification.....	15
2.2.1 Dimensions (Telescopic Arm).....	15
2.2.2 Model Specification.....	16
2.2.3 Pneumatic Source Requirement.....	19
2.3 Electrical Connection.....	19
2.3.1 Main Power Supply.....	19
2.4 Adjusting the Axis Positions	20
2.4.1 Adjusting the X-position.....	20
2.4.2 Adjusting the Y-position.....	21
2.4.3 Adjusting the Z-position.....	21
2.5 Gripper and Suction Monitoring.....	22
2.5.1 Gripper Setting.....	22
2.5.2 Digital Pressure Switch.....	22
2.5.3 Digital Pressure Switch Setting.....	22
3. General Description	24
3.1 ST2 Series Abstract.....	24

3.2	Features	24
3.3	Functions	25
3.3.1	Description.....	25
3.3.2	Malfunction Protection	25
3.3.3	Shock Absorber	25
3.3.4	Function Detection.....	25
3.3.5	Pick and Place.....	25
3.3.6	Self-protection	25
3.3.7	Emergency Stop Function	26
3.4	Default Setting.....	26
3.5	ST2 Robot Reversing.....	26
4.	Operating Instruction	31
4.1	Hand Controller.....	31
4.1.1	Operation Panel of Hand Controller.....	31
4.1.2	Hand Controller Keys	32
4.2	Servo Axes Setting and I/O Extend.....	33
4.2.1	Servo Axes Setting	33
4.2.2	I/O Extend.....	33
4.3	Loop	34
4.4	System Startup.....	36
4.5	Manual Mode	37
4.6	Auto Mode.....	38
4.6.1	Select Current Program	38
4.6.2	Auto Running.....	38
4.7	Program Parameter.....	39
4.7.1	Main Menu.....	39
4.8	Program File Management.....	40
4.8.1	Program File Explorer.....	40
4.8.2	Program Rename	40
4.8.3	Copy Program	41
4.8.4	Delete Program	41
4.9	Modify Program Parameters	42
4.10	Modify Production Schedule	42
4.11	I/O Port Monitor.....	44

4.12	System Setup Parameters	44
4.13	Setup System Parameter	47
4.14	Current Alarms and Alarm Resume	50
4.15	System Information	51
4.16	Teach Mode	51
4.16.1	Enter Teach Mode.....	51
4.16.2	Insert Actions.....	52
4.16.3	Program Branch Control.....	56
4.17	Program/System Value	58
5.	Alarm Message	59
6.	Maintenance.....	62
6.1	General	62
6.2	Lubrication Requirements	62
6.3	Maintenance Cycle.....	62
7.	Assembly Diagram	63
7.1	Traverse Unit.....	63
7.2	Parts List	64
7.3	Main Arm Unit	65
7.4	Parts List	66
7.5	Crosswise Unit	67
7.6	Parts List	68
8.	Electric Control Chart	69
8.1	The Power Input Wiring Diagram	69
8.2	The Panasonic Servo Motor Wiring Diagram	70
8.3	The Panasonic Servo Motor and I/O Board Wiring Diagram.....	71
8.4	The Delta Servo Motor and Servo Driver Wiring Diagram.....	72
8.5	The Delta Servo Motor and I/O Board Wiring Diagram	73
8.6	The Cuinsico Servo Motor and Servo Driver Wiring Diagram	74
8.7	The Cuinsico Servo Motor and I/O Board Wiring Diagram.....	75
8.8	Z-axis I/O Board Wiring Diagram	76
8.9	Main Arm Wiring Diagram 1	77
8.10	Main Arm Wiring Diagram 2	78
8.11	Sub-arm Wiring Diagram.....	79

8.12 IMM (injection molding machine) Wiring Diagram 1	80
8.13 IMM (injection molding machine) Wiring Diagram 2	81
8.14 Main Control Board Component Layout (U1)	82
8.15 Pneumatic Schematic Diagram	83

Table Index

Table 2-1: Specification List.....	16
------------------------------------	----

Picture Index

Picture 2-1: X and Z Axes Servo Telescopic.....	15
Picture 2-2: Y and Z Axes Servo Telescopic.....	15
Picture 2-3: X and Z Axes Servo.....	16
Picture 3-1: before modified.....	27
Picture 3-2: after modified.....	27
Picture 3-3: before modified	27
Picture 3-4: after modified	28
Picture 3-5: before modified	28
Picture 3-6: after modified	29
Picture 3-7: before modified	29
Picture 3-8: after modified	29
Picture 7-1: Traverse Unit.....	63
Picture 7-2: Main Arm Unit.....	65
Picture 7-3: Crosswise Unit	67
Picture 8-1: The Power Input Wiring Diagram	69
Picture 8-2: The Panasonic Servo Motor Wiring Diagram	70
Picture 8-3: The Panasonic Servo Motor and I/O Board Wiring Diagram	71
Picture 8-4: The Delta Servo Motor and Servo Driver Wiring Diagram.....	72
Picture 8-5: The Delta Servo Motor and I/O Board Wiring Diagram	73
Picture 8-6: The Cuinsico Servo Motor and Servo Driver Wiring Diagram.....	74
Picture 8-7: The Cuinsico Servo Motor and I/O Board Wiring Diagram	75
Picture 8-8: Z-axis I/O Board Wiring Diagram.....	76
Picture 8-9: Main Arm Wiring Diagram 1	77
Picture 8-10: Main Arm Wiring Diagram 2	78

Picture 8-11: Sub-arm Wiring Diagram	79
Picture 8-12: IMM (injection molding machine) Wiring Diagram 1	80
Picture 8-13: IMM (injection molding machine) Wiring Diagram 2	81
Picture 8-14: Main Control Board Component Layout (U1)	82
Picture 8-15: Pneumatic Schematic Diagram	83

1. Transportation and Storage



During transporting the robot, working underneath the robot is forbidden.



If it is necessary to remove or reinstall the robot, please contact the agent or manufacturer for help. The manufacturer and agent do not have any responsibility for injuries or damage if the customers remove robots themselves.

1.1 Transportation

1. ST2 series robot is fix on a steel structure base and packaged with crate.
2. Before transporting, fasten the sliding base to prevent any collision.
3. The arms are free to slide when electric power and pneumatic supply are off. Before packaging, push arms upwards and lock arms.
4. During transporting, please keep the robot away from other objects, in order to avoid damages.
5. Should increase plastic bag out of the robot, and if necessary, pumping vacuum and put desiccant in the packing during the long-distance transporting.
6. The temperature between -25°C to 55°C during the transportation, for short transportation (inner 24 hours), the temperature can not higher than 70°C . The robot you order before sending out the factory, it is confirmed in good working condition, please check whether there is any damage during carrying or transporting. Please be carefully, when dismantling of components and packaging, if the robot has found the injury, you can use the package again.

If there is any damage caused by transport, please:

- 1) Feedback immediately to the transportation companies and our company.
- 2) Claim damages to the shipping company; fill in the file request for compensation.
- 3) Retain the damage items wait for testing. Until the testing is completed, do not return the damaged items.

1.2 Transportation after Unpacking

1. After taking apart the package, first removed the supporting plate. To do as following:
 - 1) Release 6 fixed screws on the supporting board, remove the packing support plate.
 - 2) Rotate beams and arm slowly, so that the arm and the beam was vertical.
 - 3) Lock the arm connecting plate and the sliding seat by the 6 screws on the supporting plate.

Note: 1) Remove the packing support plate should be careful to prevent the arm wrist and the machine damage or personal injury.

2) Lock the arm connecting plate and the sliding seat, ensure that the arm in vertical state.

2. There is a ring in the parts box when the robot sent, after taking apart the package, the ring is installed on the T-block of the vertical beam, using with the two ends of the beam. (see the picture)

Note: after hoisting, please keep rings of the vertical beam, and use again next time.

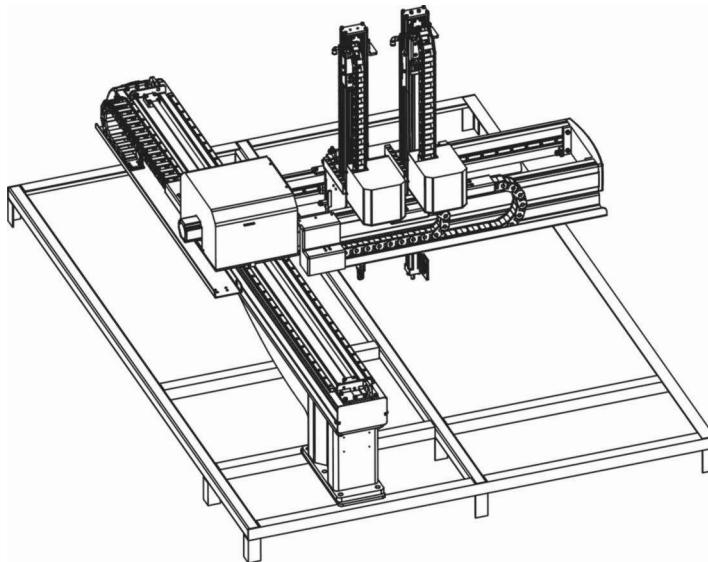

Packing of ST2-T

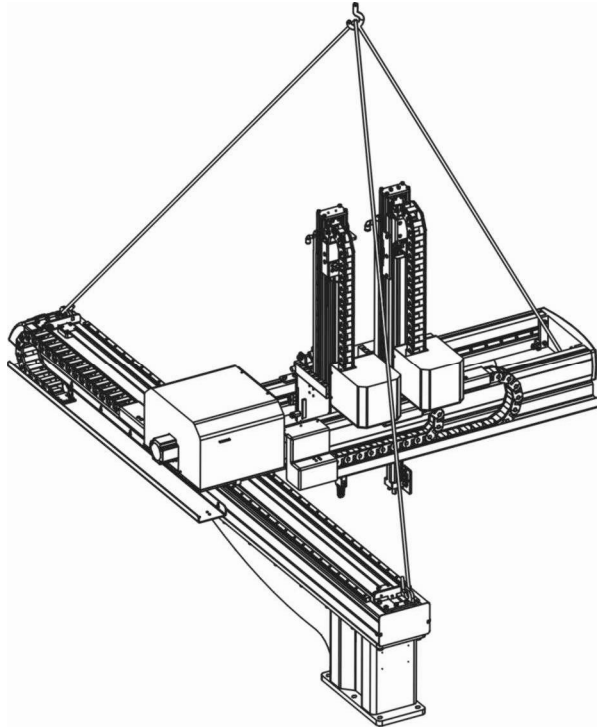

Hanging Transportation of ST2-T

1.2.1 Storage

1. Switch off the main air source and power, if robot is not use for a long time.
2. Robots should be stored in ventilated, dry room to prevent rust and damping.
3. If not use for a long time, please anti-rust, and if necessary place film to prevent dust and erosion.

1.2.2 Operation Environment

1. Temperature: between $+5^{\circ}\text{C}$ to $+40^{\circ}\text{C}$.
2. Humidity: temperature $+40^{\circ}\text{C}$, relative humidity 50%.
3. Elevation: under 1000 meters above sea level.
4. Stop using the product immediately when the following occurs:
 - I .Power cable is damaged.
 - II .Air tube is damaged.
 - III. Air pressure is not enough or too high.
 - IV.Machine breaks down or dissembled by unauthorized personal.
 - V .There are organic solvent, acidic phospholipids, sulfurous acid, and chlorine, flammable and explosive dangerous matter in compressed air.

1.2.3 Retirement

When the robot goes to its end of service life, it should be demolished according to different material (metal, oil, lubricants, plastic, rubber, etc.) to split in different ways. Deal with the machine according to local requirements; ensure the commission company as the best.

1.3 Exemption Clause

The following statements clarify the responsibilities and regulations born by any buyer or user who purchases products and accessories from Shini (including employees and agents).

Shini is exempted from liability for any costs, fees, claims and losses caused by reasons below:

1. Any careless or man-made installations, operation and maintenances upon machines without referring to the Manual prior to machine using.
2. Any incidents beyond human reasonable controls, which include man-made vicious or deliberate damages or abnormal power, and machine faults caused by irresistible natural disasters including fire, flood, storm and earthquake.
3. Any operational actions that are not authorized by Shini upon machine, including adding or replacing accessories, dismantling, delivering or repairing.
4. Employing consumables or oil media that are not appointed by Shini.

Any problems please contact with Shini agent or Shini company:

Headquarters & Taipei Factory	TEL: (02)26809119
China Service Hotline:	TEL: 800-999-3222
Dongguan Factory	TEL: (0769)83313588
Nongbo Factory	TEL: (0574)86719088

2. Installation

2.1 Instruction

2.1.1 Safety Issue

1. Before installation, please read this chapter carefully.
2. Fix robot on the base before operating.
3. After installing robot, indicate the working area with safety fence.
4. The hand controller should be placed outside of the safety fence.
5. Keep the air pipe in good way during installation.
6. The power connection should be performed only by authorized electrician.
7. Connecting cable and the grounded should obey the local rules and regulations
8. The grounded wire can not attach to the water pipes, gas pipes, telephone lines or television cables.
9. Use the independent cable and power switch, the diameter of main power wire can not be less than the wire of control box.
10. The end of the power wire must be safety and immobility.

2.1.2 Compressed Air Connection

1. According to the filter specifications to choose a suitable hose connected between the air source and filter.

Note: before connecting hoses, clean the hoses by compressed air. To ensure that there is no cuttings, sealing tapes in it.

2. Check the air connection of control box in good conditions, without bending conditions.

2.1.3 Electric Power Connection

1. The electrical connection should be performed only by authorized electrician.
2. Shut off the power supply before connection.
3. Set up the safety electrical outside of the control system to keep the control system works in normally.
4. Before installation, wiring, operation, and maintenance must be familiar with instructions guide as well as machinery, electronics and security attentions.
5. Ground the wire before robot operating.
6. Wiring grounding should connect to metal and keep away from inflammable matter.

The power requirements are given on the type plate of the robot, the power connection is provided through a normal power cord and a CEE plug.



The power connection should be performed only by authorized electrician and should be in accordance with any applicable regulations.

2.1.4 Safety Fence

1. After installing the robot, indicate the safety fence outside the scope of the robot working area.
2. The hand controller should be fixed outside of the safety fence.
3. Stick the warning signals on outstanding place of the fence.

2.1.5 Mounting Preparation

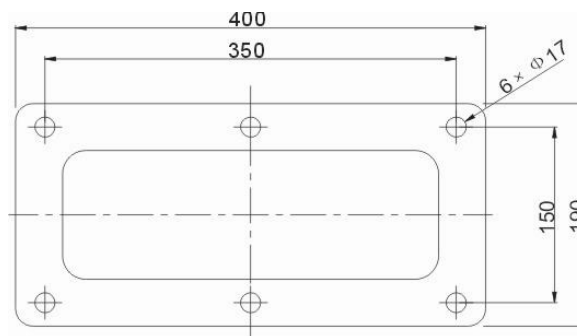

1. Before drilling, switch off the injection molding machine and then turn off the power, avoid the scrap-iron into the mold.
2. Stock the drilling picture on the installing surface of IMM.
3. Use the center punch to assist drilling.
4. Place the magnetic drill on the fixing plate, use drill bits ($\Phi 14$) to drill holes about 30mm depth.
5. Tapping. Use M16 tap to produce internal 6 screws threads about 25mm depth.

2.1.6 Mounting Instruction

1. Should avoid vibration, collision and falling, when transfer the top of IMM.
2. Alignment holes, using the 8mm torque wrench turn to 77Nm tightens the M16×30 hex socket screws.

Note: if with the transition plate, fix it on the injection molding machine, then fix robot on transition plate.

2.2 Equipment Specification

2.2.1 Dimensions (Telescopic Arm)

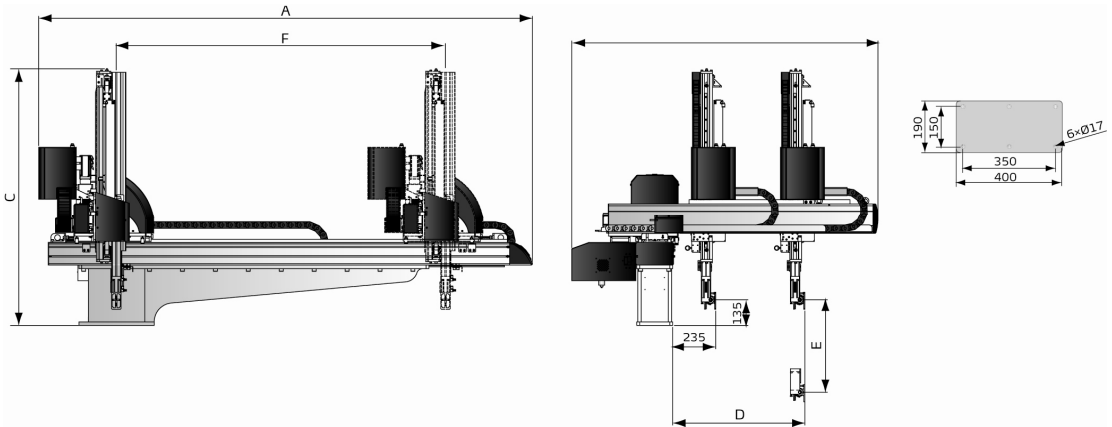

Picture 2-1: X and Z Axes Servo Telescopic

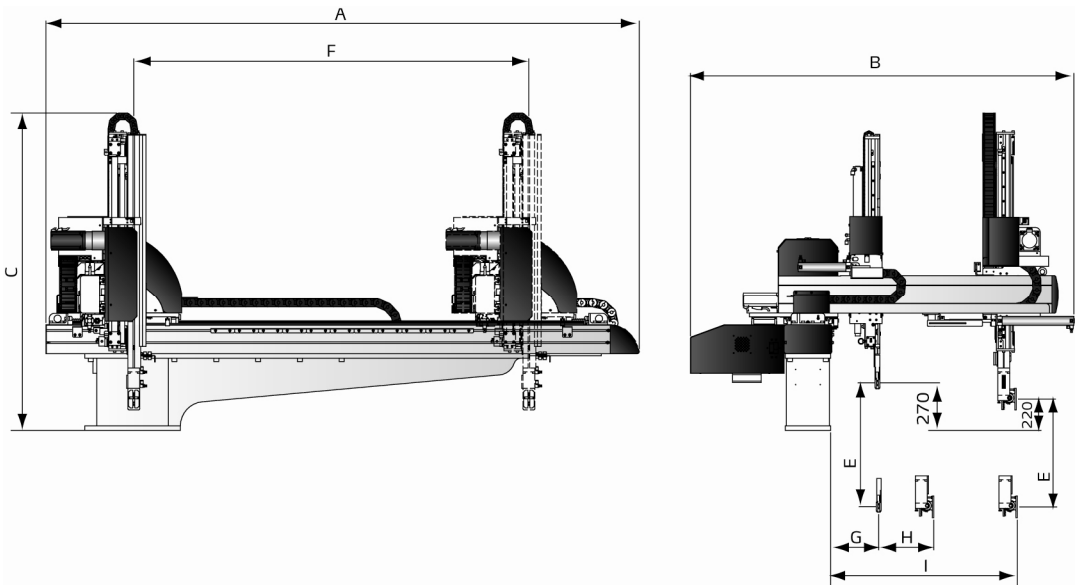

Picture 2-2: Y and Z Axes Servo Telescopic

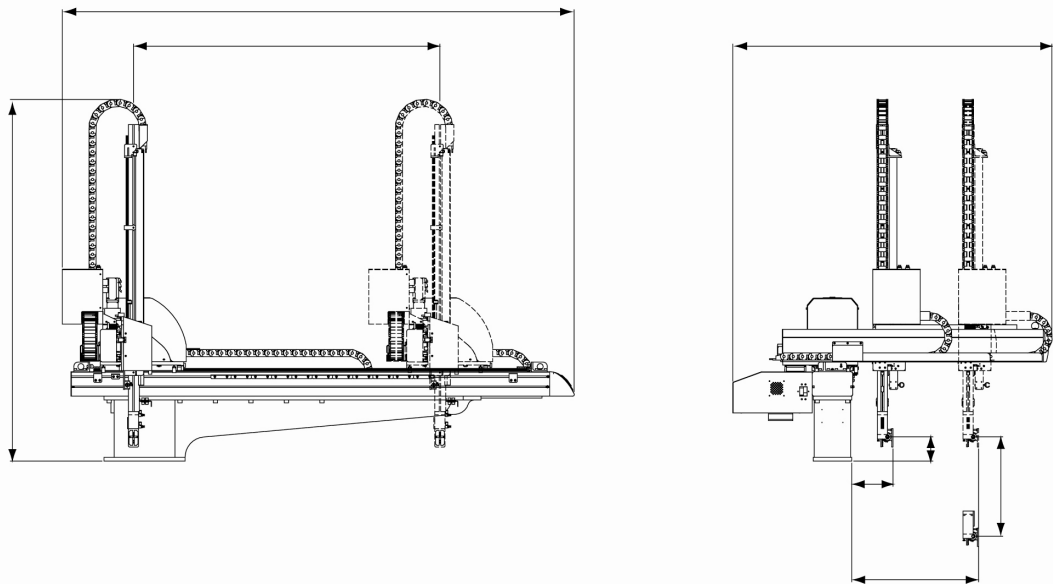

Picture 2-3: X and Z Axes Servo

2.2.2 Model Specification

Table 2-1: Specification List

Model		ST2-700-1400T	ST2-900-1600T	ST2-1100-1800T	ST2-700-1400
IMM (ton)		100-200	200-300	300-450	100-200
Traverse(mm)		1400	1600	1800	1400
Crosswise stroke (mm)	Main arm	460	580	700	480
	Sub-arm	/	/	/	/
Vertical stroke (mm)	Main arm	700	900	1100	700
	Sub-arm	/	/	/	/
Max Load (with tool) (kg)		3	3	3	3
Min Pick-out Time (sec)		2.0	2.2	2.5	2.0
Min Cycle Time (sec)		6.3	6.5	7	6.3
Air pressure range (bar)		4-6	4-6	4-6	4-6
Max Air Consumption (NL/cycle)*		7.5	9.5	11.5	9
Net Weight (kg)		260	280	300	240
Dimensions (mm)	A	2300	2500	2700	2300
	B	1430	1550	1670	1430
	C	1250	1350	1450	1600
	D(max)	700	820	940	690
	E(max)	700	900	1100	700
	F(max)	1400	1600	1800	1400
	G(max)	/	/	/	/
	H(max)	/	/	/	/
I(max)	/	/	/	/	

Model		ST2-900-1600	ST2-1100-1800	ST2-Y700-1400T	ST2-Y700-1400DT
IMM (ton)		200-300	300-450	100-200	850-1600
Traverse(mm)		1600	1800	1400	1400
Crosswise stroke (mm)	Main arm	600	720	150	150
	Sub-arm	/	/	/	100
Vertical stroke (mm)	Main arm	900	1100	700	700
	Sub-arm	/	/	/	750
Max Load (with tool) (kg)		3	3	3	3
Min Pick-out Time (sec)		2.2	2.5	2	2.2
Min Cycle Time (sec)		6.8	7	6.6	6.6
Air pressure range (bar)		4-6	4-6	4-6	4-6
Max Air Consumption (NL/cycle)*		11	13.5	7	12
Net Weight (kg)		250	260	250	270
Dimensions (mm)	A	2500	2700	2300	2300
	B	1550	1670	1430	1430
	C	1800	2000	1350	1350
	D(max)	810	930	700	700
	E(max)	900	1100	/	750
	F(max)	1600	1800	1400	1400
	G(max)	/	/	/	110
	H(max)	/	/	/	180
	I(max)	/	/	680	1200

Model		ST2-Y900-1600T	ST2-Y900-1600DT	ST2-Y1100-1800T	ST2-Y1100-1800DT
IMM (ton)		200-300	200-300	300-450	300-450
Traverse(mm)		1600	1600	1480	1480
Crosswise stroke (mm)	Main arm	250	250	300	300
	Sub-arm	/	150	/	150
Vertical stroke (mm)	Main arm	900	900	1100	1100
	Sub-arm	/	950	/	1150
Max Load (with tool) (kg)		3	3	3	3
Min Pick-out Time (sec)		2.1	2.3	2.2	2.5
Min Cycle Time (sec)		7	7	7.2	7.5
Air pressure range (bar)		4-6	4-6	4-6	4-6
Max Air Consumption (NL/cycle)*		9	15	11	18
Net Weight (kg)		260	280	270	290
Dimensions (mm)	A	2500	2500	2700	2700
	B	1550	1550	1730	1730
	C	1450	1450	1550	1550
	D(max)	900	900	1100	1100
	E(max)	/	950	/	1150
	F(max)	1600	1600	1800	1800
	G(max)	/	170	/	170
	H(max)	/	180	/	180
	I(max)	800	800	920	920

Model		ST2-Y1300-2000T	ST2-Y1300-2000DT	ST2-Y1500-2200T	ST2-Y1500-2200DT
IMM (ton)		450-650	450-650	650-850	650-850
Traverse(mm)		2000	2000	2200	2200
Crosswise stroke (mm)	Main arm	400	400	400	400
	Sub-arm	/	200	/	200
Vertical stroke (mm)	Main arm	1300	1300	1500	1500
	Sub-arm	/	1350	/	1550
Max Load (with tool) (kg)		10	10	12	12
Min Pick-out Time (sec)		3.2	3.2	3.5	3.5
Min Cycle Time (sec)		8.5	8.5	9	9
Air pressure range (bar)		4-6	4-6	4-6	4-6
Max Air Consumption (NL/cycle)*		10	10	12	30
Net Weight (kg)		500	750	550	850
Dimensions (mm)	A	2700	2700	2900	2900
	B	1890	1890	1950	1950
	C	1600	1600	1700	1700
	D(max)	1300	1300	1500	1500
	E(max)	/	1350	/	1550
	F(max)	2000	2000	2200	2200
	G(max)	/	120	/	120
	H(max)	/	170	/	170
I(max)		1100	1100	1150	1150

Model		ST2-Y1800-2400T	ST2-Y1800-2400DT
IMM (ton)		850-1600	850-1600
Traverse(mm)		2400	2400
Crosswise stroke (mm)	Main arm	400	400
	Sub-arm	/	200
Vertical stroke (mm)	Main arm	1800	1800
	Sub-arm	/	1850
Max Load (with tool) (kg)		14	14
Min Pick-out Time (sec)		3.8	3.8
Min Cycle Time (sec)		9.5	9.5
Air pressure range (bar)		4-6	4-6
Max Air Consumption (NL/cycle)*		14	32
Net Weight (kg)		600	1000
Dimensions (mm)	A	3100	3100
	B	2010	2010
	C	1850	1850
	D(max)	1800	1800
	E(max)	/	1850
	F(max)	2400	2400
	G(max)	/	120
	H(max)	/	170
I(max)		1200	1200

Note:1. "M" stands for middle mold detector, suit for 3-pate mold.

"EM12" stands for Euromap 12 communication interface.

"EM67" stands for Euromap 67 communication interface.

2. "*" max air consumption for suction device 60NL/min.

3. Power supply: 1Φ, 200~240V.

2.2.3 Pneumatic Source Requirement

Compressed air is connected by 3/8-Φ12 trachea. Filter pressure valve with a clear scale line, convenient adjustment. Bring adjustment knob upward and with a clockwise rotation, pressure increases; counterclockwise rotation, air pressure decreases, the pressure range between 0 to 10bar. After adjustment, please press the adjustment knob to lock pressure.

ST2 robot requirement supply pressure: 4bar to 6bar.

When the pressure is equal or drop below than 4bar, the robot will stop working and alarm. When the pressure up to 6bar, it will affect the service life of pneumatic components.

2.3 Electrical Connection

2.3.1 Main Power Supply

The power requirements are given on the serial plate of the robot, the power connection is provided through cable conductor and CEE plug.



The power connection should be performed only by an authorized electrician and according to applicable electric utility regulations.



Connection of the interface plug to the machine and testing of all signals must be done by a specialist in injection molding machines and robots. Preferably, this should be done by one of our service engineers together with a qualified service engineer for the injection molding machine.



The interface signal functions must be carefully tested, as improper operation may cause malfunction or damage to the robot and the mold.



In particular, the functions of the safety circuits must be thoroughly checked.

- Testing the emergency stop signals to and from the IMM.
- When press the emergency stop switch on hand controller, the error message emergency stop must also be indicated at the IMM. And when press the emergency stop on IMM, the emergency stop signal must also be indicated at the robot.

2.4 Adjusting the Axis Positions



While adjusting the position, make sure that robot can not be run and the compressed air supply is shut off.

2.4.1 Adjusting the X-position

The X-positions are determined by the stops A, B.

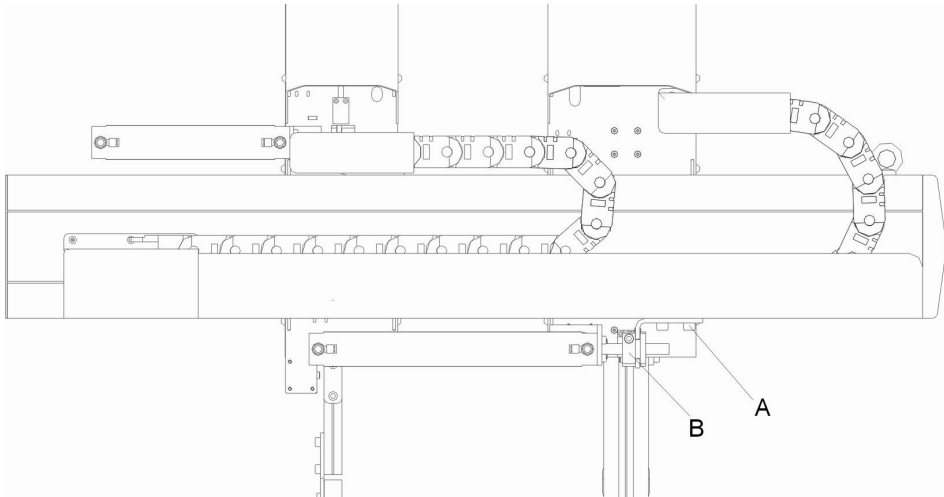

Bracket A on X1-axis (main arm) is for adjusting the end-position, and stop package B is for adjusting the stroke length and the 0-position.

Bracket B on X2-axis (sub-arm) is for adjusting the 0-position, and stop package B is for adjusting the stroke length and the end-position.

Before running in to the mold range with the Y-axis for the first time, you must check whether the X-positions can be reached without damaging the mold and the Y-axis, the end position of the X-axis must be adjusted

Adjusting the end-position of X1-axis:

- 1) Run the X1-axis to its end position
- 2) Release bracket A
- 3) Push bracket A to shock absorber, in the compression state
- 4) Fix the stop package A

Adjusting the 0-position of X1-axis (the length of stroke)

- 1) Release stop package B
- 2) Run the X1-axis to the 0-position
- 3) Manually push cylinder position rod to the fully extended state
- 4) Fix the stop package B

Adjusting the 0-position of X2-axis:

- 1) Run the X2-axis to its 0-position
- 2) Release bracket A
- 3) Manually push bracket A to shock absorber, in the compression state
- 4) Fix the stop package A

Adjusting the end-position of X2-axis (the length of stroke):

- 1) Release stop package B
- 2) Run the X2-axis to its end-position
- 3) Manually push cylinder position rod to the fully extended state
- 4) Fix the stop package B.

2.4.2 Adjusting the Y-position

Set the end-position of Y-axis to its end position

Adjusting the end-position of Y-axis:

- 1) Loosen shock absorber on the end-position
- 2) Push the cylinder on Y-axis to its end-position
- 3) Rotate the up-going shock absorber to the in fully compression state
- 4) Fix the shock absorber

The pick-up position can be set using the stop package.

Adjusting the Pick-up Position:

- 1) Run the Y-axis to its end position
- 2) Seal off the compressed air
- 3) Loosen the Y-axis stop package
- 4) Manually push Y-axis to the desired position
- 5) Push stop package to shock absorber, in the compression state
- 6) Fix the Y-stop package

Note: the down shock absorber completely compressed, the top position of shock absorber shall not be lower than the origin of position sensor, if not, when arm down, the down-block will damage the origin sensor.

2.4.3 Adjusting the Z-position

The Z-axis position can be using servo control system.

2.5 Gripper and Suction Monitoring

2.5.1 Gripper Setting

If the gripper didn't clamp parts in opened state or in the closed state, the light of the magnetic sensor is off. If the gripper clamped parts, the magnetic sensor is on.

Adjusting the Magnetic Sensor:

1. Loosen the screw which is fixed on the magnetic sensor.
2. Make the light on when gripper clamp the parts, if not make the light off.
3. Tighten the fixing screw after finishing adjustment.

During the robot working, if the grippers not clamp the part, the robot will stop operating and alarm.

2.5.2 Digital Pressure Switch

1. The default setting is 4bar, it can be adjusted according to the actual needs.
2. Digital pressure switch marked with scale, the internal of the digital pressure switch has a red ruler, which connected with the adjustment screw, when the rotation adjustments screw, the red ruler will move too.
3. Need to adjust the pressure, the user can rotate red ruler to set the valve by the hex key, clockwise rotation, the value increased, counter-clockwise rotation, the value decrease.

2.5.3 Digital Pressure Switch Setting

For CKD pressure switch:

Ø Hysteresis mode:

- a: Press "Mode" 2 seconds in measurement mode into "Comparative output 1 mode setting". Press up/down key till the screen display "HYS".
- b: Press "Mode" once into "Comparative output 2 mode setting". Press up/down key till the screen display "OFF".
- c: Press "Mode" once into "N.o./N.c. selection"(Normal open or normal close). Press up/down key till the screen display "NC".
- d: Press "Mode" once into "Response time setting". Press up/down sets the response time (default setting: 2.5ms).
- e: Press "Mode" once into "Displayed color of the main display selection". Press up/down key till the screen display "R-ON".
- f: Press "Mode" once back to "measurement mode 1".

Ø Pressure value range setting:

The upper limit: for example “-50”, press “Mode” screen display “L0-1”, press up/down set the valve to “-50”.

The lower limit: for example “-30”, press “Mode” screen display “H1-1”, press up/down set the valve to “-30”.

Note: if the lower limit value smaller than the upper limit, pressure switch will display pressure “DOWN” error message.

Ø Lock button:

After setting value, press “Mode” and “down” keys together till screen displays “LOCK, ON”. This operation is preventing error change pressure value.

Ø Remove lock button:

Press “Mode” and “down” keys together till screen display “LOCK, OFF”.

For SMC pressure switch:

1. Press “S” for 2 seconds till screen displays “F**”, use up/down keys to select “F0”, press “S” into “unit selection mode”, use up/down keys to select “PA”, press “S” complete setting and back to “function selection mode”, screen displays “F0”.
2. Press up/down till screen displays “F1”, press “S” into “OUT1 specification setting”, and use up/down keys to select “HYS”, press “S” into “out mode setting”.
3. Use up/down keys to select “L-n”, press “S” into “pressure setting”.
4. Use up/down keys to set pressure to “-50” (the value can be changed according to application). Press “S” into “Hysteresis mode”.
Use up/down keys to set value to “2”. Press “S” into “displayed color of the main display selection” .
5. Use up/down keys to select “Sor”, press “S” back to “function selected mode”.
6. Press “S” for 2 seconds back to “measurement mode”.

3. General Description

3.1 ST2 Series Abstract

ST2 series robot is designed for sprue and products from injection molding machine. One arm and double arms, standard and telescopic arms are selectable according to the application of 2-plate mold, 3-plate mold or hot runner system.



Model: ST2

3.2 Features

1. Appearance: compact and attractive appearance.
2. Conveniences: I/O circuit connection using convenience plug-in design, easy to installation and maintain.
3. Safety: with safety switches on each limit positions.
4. Function: with stack function.
5. Withdrawal: pick out part quickly and accurately, place part precision, ensure not to collision parts.
6. Humanization: use the humanization control system, easy to operate.
7. Package: mainly used wrist packing designs which can save room, avoid damage during transportation.

3.3 Functions

3.3.1 Description

ST2 series robot is mainly used for injection molding part and the sprue removed, all major parts of the robot are equipped with shock absorber devices and magnetic sensor, there is a die locking device with high security features on the arms. The main arm with quickly-pick, accurately-put function, it is not only guarantee the glove extract speed also ensure that the object is not damaged. For convenience of users packaging, this series robot with stack function, users can achieve two-stack (the X-axis) and Z-axis and Y-axis direction of an arbitrary stack, or two-stack (the Y-axis) and Z-axis and X-axis direction of an arbitrary stack.

3.3.2 Malfunction Protection

Both the origin position and end position of the robot's stroke parts are with limited sensor switch. The devices of the limited position are on the two ends of the stroke axis (Z axis) and vertical axis (X axis), prevent robot anti-falling.

3.3.3 Shock Absorber

There are shock absorbers on the main arm up/down position, sub-arm up/down position, and the position of main arm forward and forward and sub-arm backward. The main arm backward position and the forward position of sub-arm with air-cushion devices, which can reduce the impact of the robot when it is operating.

3.3.4 Function Detection

ST2 series robot with limit sensor switches on traverse origin-position and end-position. Position limit devices on both two end of Z-axis and X-axis to protect robot if any occur accidents.

3.3.5 Pick and Place

The arm with quickly-pick and accurately-put function, you can adjust the flow regulating valve on the main arm to change to putting speed.

3.3.6 Self-protection

There is an anti-falling cylinder at below of the arm, which can effectively

prevent the personal injury or machine damage caused by arm down or lack of air pressure. If air pressure is insufficient, the pressure sensor output signal, the arm back to up-limited, the arm was locked by ejected anti-falling cylinder piston rod. If the pressure is enough, anti-fall cylinder piston rod returns back.

When the robot's arm in locked state, if need manually push arm up and down, use flat tool to move anti-falling cylinder piston rod back, avoid damage to the arm or anti-falling cylinder.

3.3.7 Emergency Stop Function

The emergency stop button is located on the hand controller. When an emergency stop button is pressed, the power is turned off. The gripper and vacuum valves and the vacuum pump are not disconnected, to avoid dropping parts from the gripper. In addition, the controllers will remain under power to allow indication of error messages. If robot goes out of order or need emergency stop for examinations, press the emergency stop button to ensure safety operation.

3.4 Default Setting

1. Traverse speed: the initial setting is 85%.
2. Pressure sensor: the initial setting is 4bar, if air pressure is less than 4bar, the robot will stop working and alarm.
3. Filter regulating valve: the factory setting is 6bar.
4. Vacuum pressure switch: the factory setting is -50.

3.5 ST2 Robot Reversing

The following paragraph is the instruction for changing robot dropping side (operation side to non-operation side). For the safety purpose, please turn off the electrical power and pneumatic supply before carrying on the instruction.

1. Unscrew the proximity sensor X103 and move it up to the same level as X102, then tighten X103. Unscrew the proximity sensor X102 and move it down to the same level as where X103 was, and then tighten X102. See picture 3-1, 3-2.



Picture 3-1: before modified



Picture 3-2: after modified

2. Move all “outside IMM safety zone blocks” to the other end of the beam. See picture 3-3, picture 3-4.



Picture 3-3: before modified



Picture 3-4: after modified

3. Move in mold sensor blocks to Z-axis belt fixed block, keep the distance about to 180mm.



4. Open the sliding seat on the Z-axis, and then exchange the socket position of X101 and X104, also exchange the socket position of X102 and X103, on the circuit board U2. See picture 3-5, 3-6.

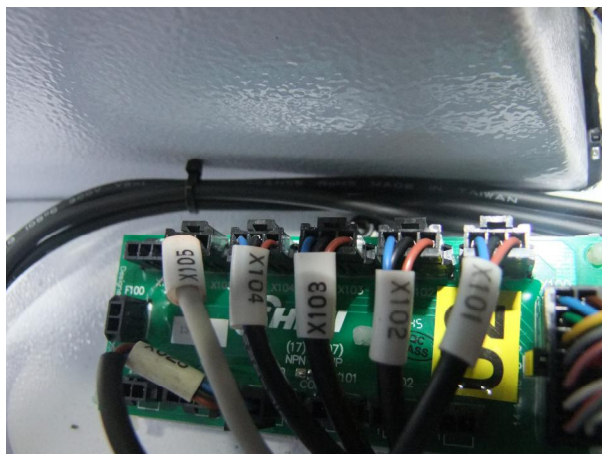

Picture 3-5: before modified

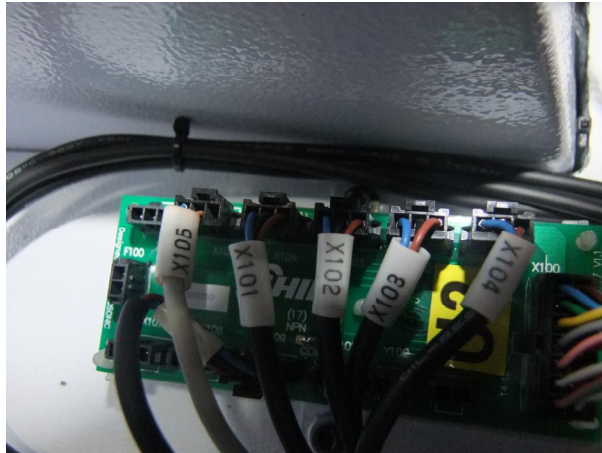

Picture 3-6: after modified

5. Change robot direction to reverse in hand controller. See picture 3-7, 3-8.

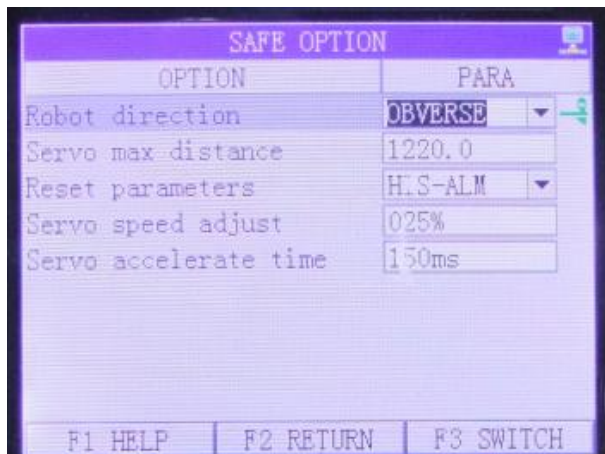

Picture 3-7: before modified

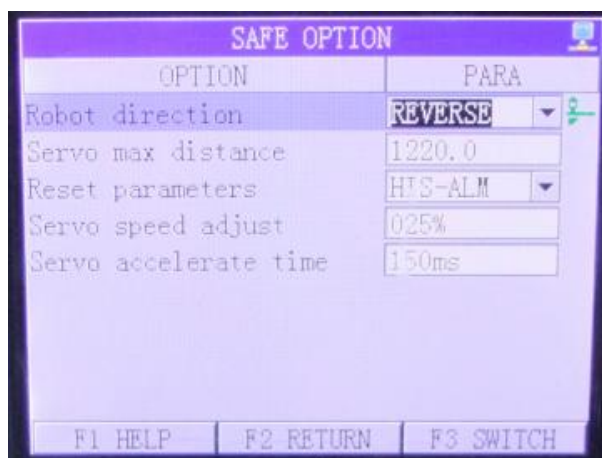

Picture 3-8: after modified

6. Horizontal rotate robot base 180 degree and move to the other end of beam then tighten it.
7. Robot reversing result checking.

Press “home position”, robot will move reverse. After robot back to home position, Z-axis home position sensor (X103) light up. When robot running, limit sensor light up.

































4. Operating Instruction

4.1 Hand Controller

4.1.1 Operation Panel of Hand Controller



4.1.2 Hand Controller Keys

	change digit		up
	F1		down
	F2		left
	F3		right
	options toggle, or increase values		options toggle, or decrease values
	manual, stop auto running		main arm rotate horizontal/vertical, or number "1"
	auto running		main arm forward/backward /up /down, or number "2"
	home position		main arm vacuum, or number "3"
	return		main arm grip, or number "4"
	enter/exit		extend port or number "5"
	program branch		sub-arm up/down, or number "6"
	IMM Euromap 12 or Euromap 67 signal		sub-arm forward/backward, or NO. "7"
	program loop		sub-arm grip or number "8"
	servo axis up/backward		servo down/forward, or number "9"
	servo axis traverse out		servo axis traverse in or NO. "0"
	menu		modify program

	teach program	 emergency stop
	alarm	
	help	

4.2 Servo Axes Setting and I/O Extend

4.2.1 Servo Axes Setting

Z-axis and Y-axis servo: Y-axis (vertical axis) origin-position at main arm up-position, Z-axis (traverse axis) origin-position at outside mold position.

Z-axis and X-axis servo: X-axis (crosswise axis) origin-position at backward-position, Z-axis (traverse axis) origin-position at outside mold position.

Only robot in mold safety zone and outside mold safety zone, servo axes can move. Only servo Y on origin-position, servo Z can move.

	in mold safety zone		outside mold safety zone	
	begin	end	begin	end
Y-axis	Y origin-position	Y software max traverse	Y origin-position	Y software max traverse
X-axis	X origin-position	X software max traverse	X origin-position	X software max traverse
Z-axis	Z in mold safety position	software max traverse	Z origin-position	Z outside mold safety position

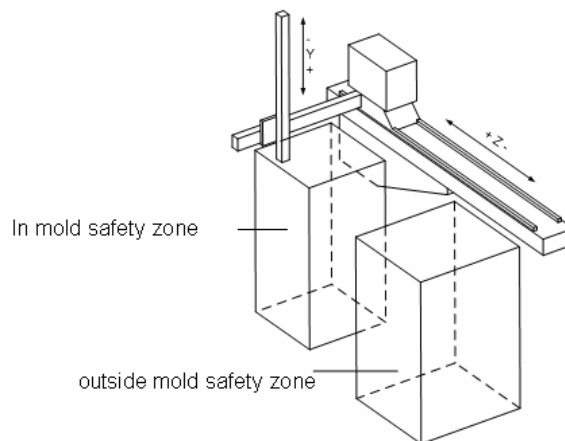

4.2.2 I/O Extend

I/O extend distribute:

System with 4 extra input ports and 5 extra output ports:

position	input extend port		output extend port	
	No.	quantity	No.	quantity
main control board	XET00 ~	4	YET00 ~	5
	XET03		YET04	

I/O extend cording

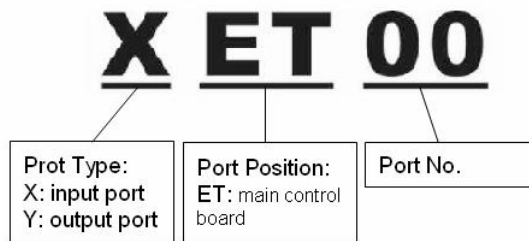

I/O extends operation:

The following page will display on screen when system needs to choose input/output port.

Press to choose port position.

Press to choose port No.

Press to choose option port and return to last page.

Press to give up option port and back to last page.

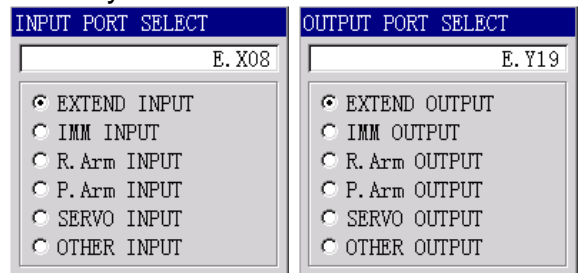

4.3 Loop

System with 10 loop areas, each cycle loop has different area according to different cycle time. Each cycle loop has two place modes: any 10 positions and matrix.

Any 10 positions mode:

Min: 1 position, max: 10 positions.

Z-axis and Y-axis servo: each positions defined by Z-axis and Y-axis. One cycle

loop, one position. Till all positions finished, robot will back to first position.

Z-axis and X-axis servo: each positions defined by Z-axis and X-axis. One cycle loop, one position. Till all positions finished, robot will back to first position.

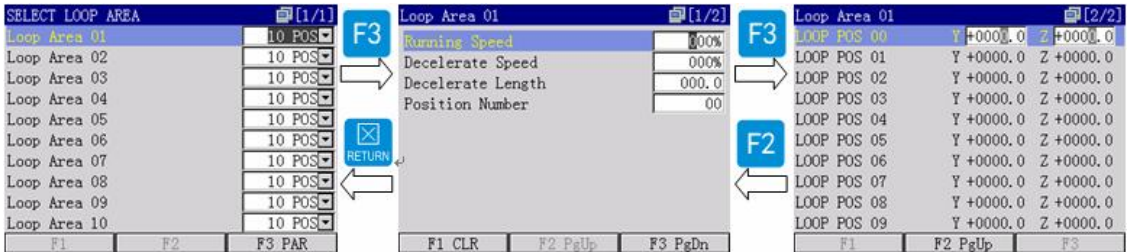

Matrix mode:

Z-axis and Y-axis servo: firstly locate Z, then Y. The value and distance of Z-axis makes up one matrix of first layer. The value and distance of Y-axis makes up one matrix of products' layers and storey.

Z-axis and X-axis servo: firstly locate Z, then X. The value and distance of Z-axis makes up one matrix of first layer. The value and distance of X-axis makes up one matrix of products' layers and storey.

The value of X, Y, Z, can be positive or negative.

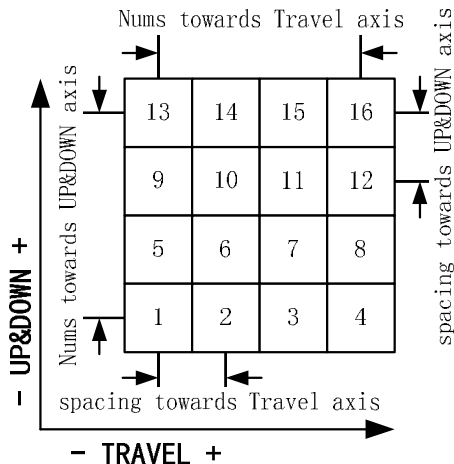

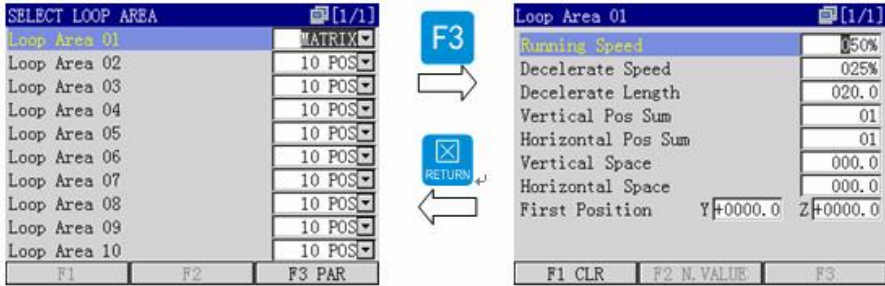

4.4 System Startup

After power on, please return to home position firstly, the steps see as following picture:

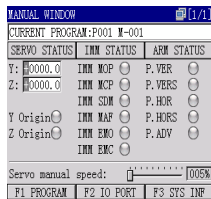
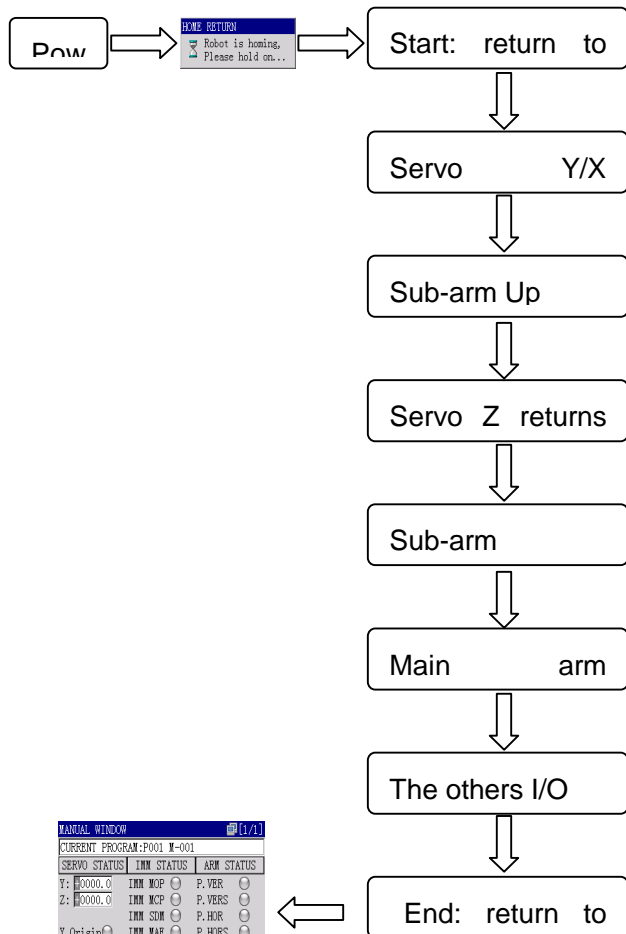

4.5 Manual Mode

Servo control mode

- Ø : move continually
- Ø : move once (10mm)
- Ø : move once (1mm)
- Ø : move once (0.1mm)

Servo control

Press to select servo axis move mode, press servo Y move down/servo X move forward.

Press to select servo axis move mode, press servo Y move up/servo X move backward.

Press to select servo axis move mode, press servo Z traverse in.

Press to select servo axis move mode, press servo Z traverse out.

Extension Input and Output

Press into page control page.

Use to select output port.

Press to open output signal.

Press to off output signal.

Press back to main screen (manual).

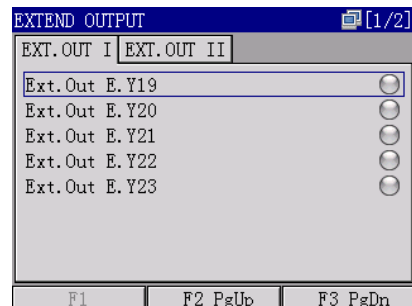

Other actions:

: main arm rotate horizontal/vertical

: (Z and Y servo) main arm forward/backward; (Z and X servo) main arm up/down



Vacuum: vacuum on/off



Main-grip: main arm grip on/off



Sub-arm: sub-arm up/down



Sub-arm: sub-arm forward/backward



Sub-grip: sub-arm grip on/off

4.6 Auto Mode

4.6.1 Select Current Program

Select one program before operating auto running.

Select one program steps:



4.6.2 Auto Running

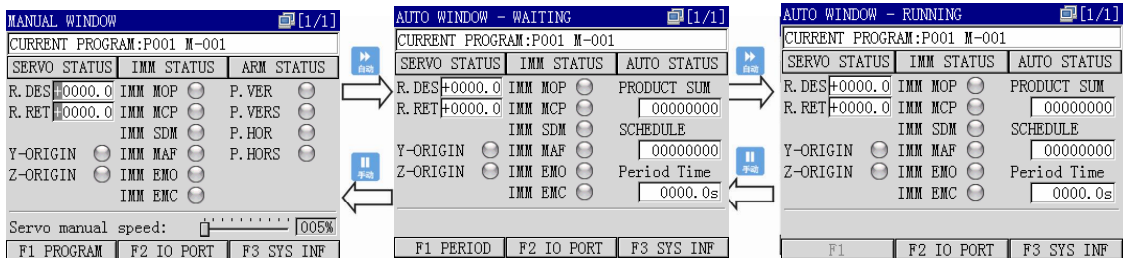

Completed

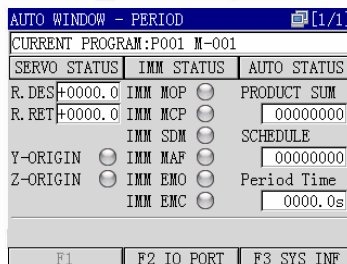

4.7 Program Parameter

4.7.1 Main Menu

Press  into control page.

Use  to select menu.

Press  into control page.

Press  into “Edit Program” page.

Press  into “Count Setup” (program parameter) page.

Press  into “Loop Areas” page.

Press  into “Wizard Mode” (Teach Mode) page.

Press  into “Servo Setup” page.

Press  into “Port Monitor” page.

Press  into “System Setup” page.

Press  into “Alarm Resume” page.

Press  into “Adjust Motor” page.

Press  into “System Inf.(information)” page.

Press  into “Main Menu” page.

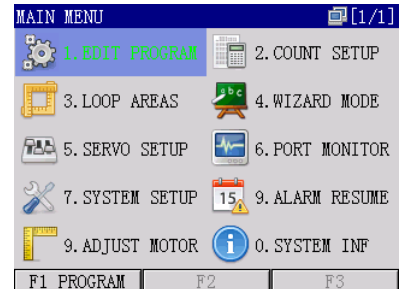

Menu Introduce:

- Ø Edit Program: modify position, speed and delay time of current program.
- Ø Count Setup (system parameter): modify parameters of current program.
- Ø Loop Areas: modify loop parameters of current program.

- Ø Wizard Mode (teach mode): teach and save the sequences of program actions.
- Ø Servo Setup: setup each servo axis parameters.
- Ø Port Monitor: monitor each input/output signal.
- Ø System Setup: setup system parameters.
- Ø Alarm Resume: show recent 30 records system alarm.
- Ø Adjust Motor: adjustment mechanical limit of robot.
- Ø System Inf. (information): show system information: robot model, version, manufacturer and so on.

4.8 Program File Management

4.8.1 Program File Explorer

Program is stored and managed as a file. Each file has a unique ID, for example, P01. The files also have name, the length of one name string is 9 characters at most. If the program has no file name, means it is a null program.

When select current program or select program in teach mode, the program explorer will be open automatically. Select current program in manual mode, or select program in teach mode to enter “program explorer” page. Rename, copy or delete files.

Use to select program file.

: copy file.

: delete file.

: rename file.

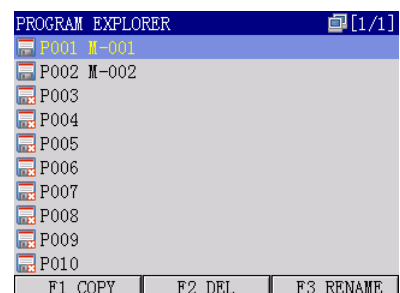

4.8.2 Program Rename

Press “F3” to rename file, the “string editor” will display on screen.

Use to input word.

: shift word capitalization and lowercase.

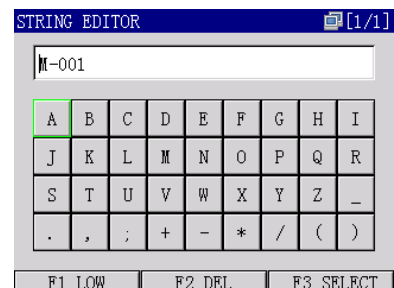



: delete word.



: input selected word.



: move word and cursor.



: confirm input word.



: give up rename file and back to last page.

4.8.3 Copy Program

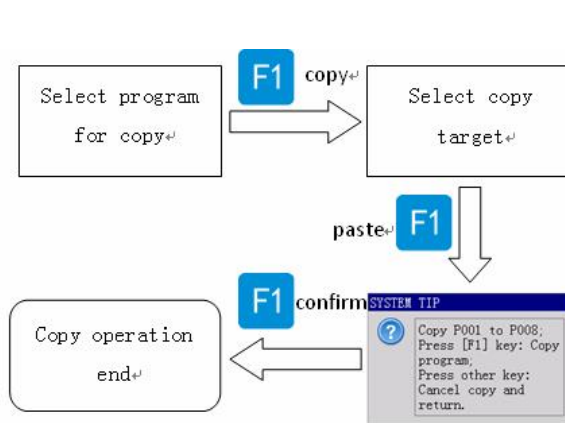

4.8.4 Delete Program

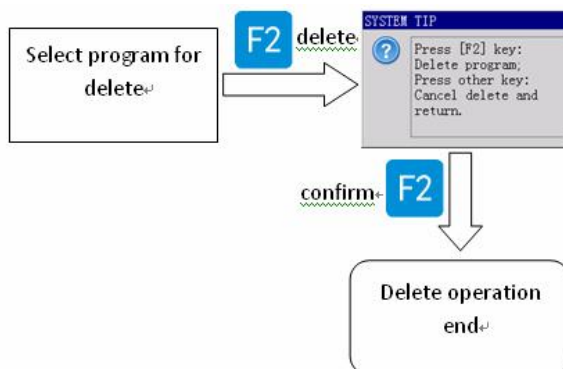

Note: the current program and blank program cannot be deleted.

4.9 Modify Program Parameters

Use to choose options.

Press to choose servo mode when modify position parameter.

Press , servo Y down/ servo X forward.

Press , servo Y up/ servo X backward.

Press , servo Z traverse in.

Press , servo Z traverse out.

Press , increase servo speed when modify position parameter; insert value when modify delay time.

Press , decrease servo speed when modify position parameter; reduce value when modify delay time.



used as number

when modify delay time parameter.

Press to move cursor when modify delay time parameter.

Press to save parameter and screen back to last page.

Press to give up modified parameter and screen back to last page.

Note: in auto running mode, servo position just can be adjusted 0.1mm or 1.0mm unit, each modify can not over $\pm 5\text{mm}$.

PROGRAM PARAMETERS			[1/1]
000	Y+0000.0	050%	
001	Enable Mould Close	00.0s	
002	Y+0000.0	050%	
003	Y+0050.0	050%	
004	ON	05.0s	
005	Y+0000.0	050%	
006	Y+0000.0	050%	
007	Enable Mould Close	00.0s	
008	Y+0000.0	050%	
009	OFF	05.0s	
F1			F2
F3 APPLY			

4.10 Modify Production Schedule

Press to select options.

Press to increase value.

PROGRAM PARAMETERS		[1/2]
Production schedule	0000000	
Reject sum for alarm	0000	
P. Arm Vacuum Check	UNUSED	
P. Arm Grip Check	UNUSED	
R. Arm Grip Check	UNUSED	
F1		F2 PgUp
F3 PgDn		

Press  to reduce value.

Press  to move cursor when modify parameters.

          used as number when input value.

Press  to save parameter and back to branch program page.

Press  to give up modifying parameter.

Count Setup (system parameter):

Production Schedule: Set the production schedule, when the released product number reaches this count, system will suspend and inform that the production schedule has finished. The minimum is 0, means no production schedule. The maximum of production schedule is 9999999.

Reject sum for alarm: Set the reject sum for alarm. When the reject number reaches this count, system will suspend and inform that the reject is out of standard. The minimum is 0, means no reject alarm. The maximum is 9999.

P.Arm (main arm) Vacuum Check: setup “main arm vacuum check” to use or unused.

P.Arm (main arm) Grasp Check: setup “main arm grasp check” to use or unused.

P.Arm (main arm) Grip Check: setup “main arm grip check” to use or unused.

4.11 I/O Port Monitor

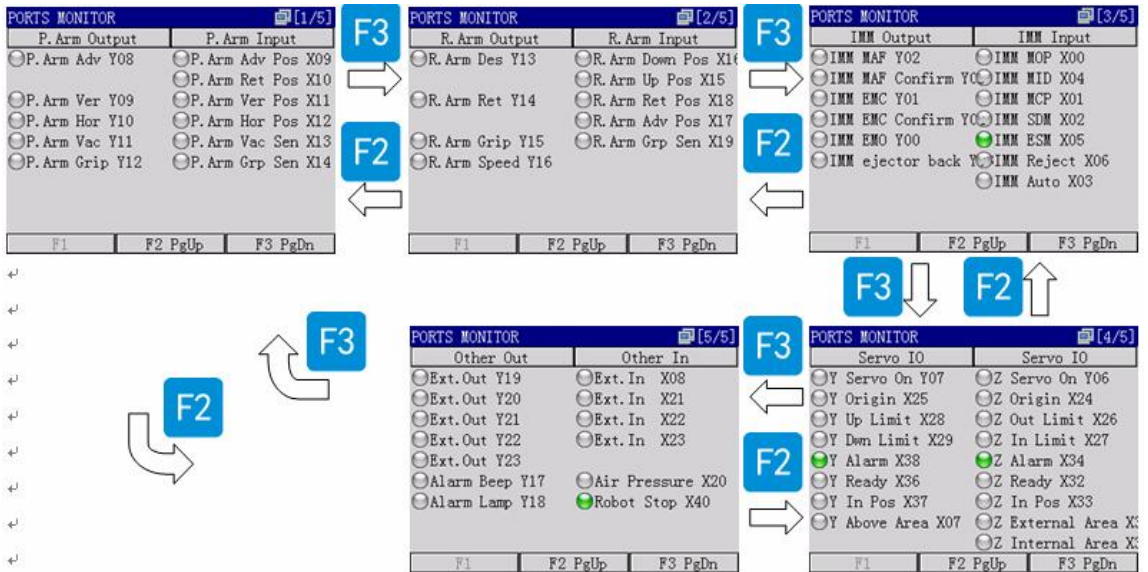

Press into "port monitor" page.

Press exit to "port monitor" page.

4.12 System Setup Parameters

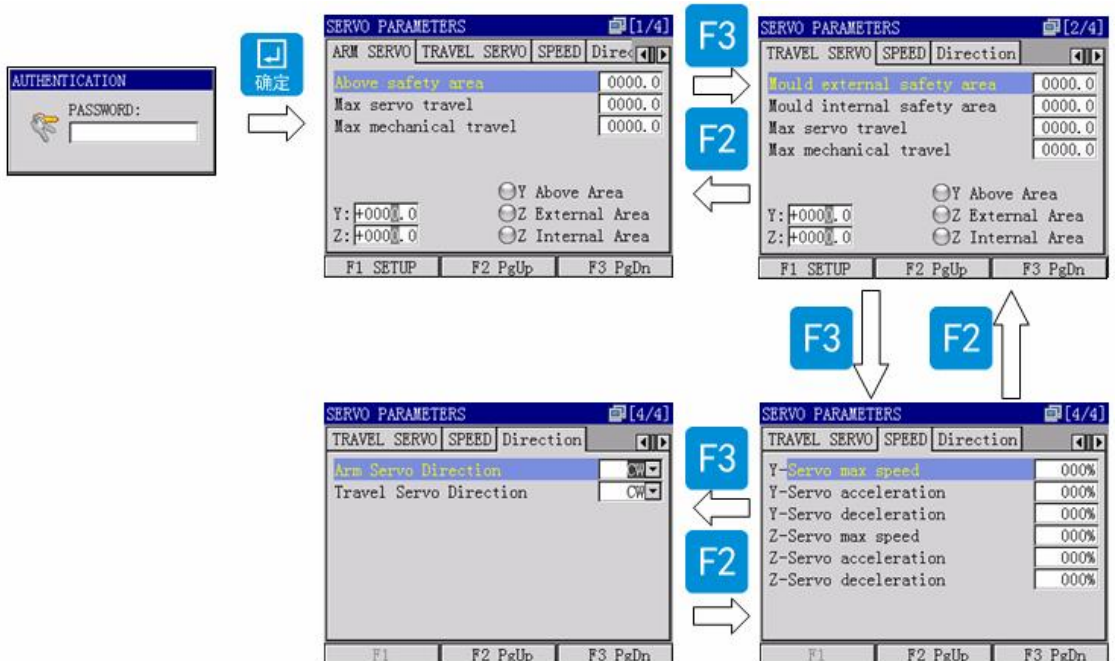



Press           to input password.

Press  to confirm password.

Press  back to main menu page.

Setup Servo Parameters:

Use   to select options.

Press  to acknowledge parameter.

Press  to page up.

Press  to page down.

Press  to select servo mode when changing placement position.



: vertical servo axis move down.



: vertical servo axis move up.



: servo Z axis traverse in.













: servo Z axis traverse out.

Press : Increase servo speed when editing position parameter; Increase digit at cursor when editing delay parameter.

Press : Decrease servo speed when editing position parameter; Decrease digit when editing delay parameter.

Press   to move cursor when editing parameter.

Press           to input value when modifying servo parameter.

Press  to save parameters and back to last page.

Press  to give up modifying and back to last page.

Servo Parameter:

1. Servo Y Parameter

Above safety area: setup the max down stroke of main arm (Y axis) after IMM mold opened.

Max servo travel: setup the max move stroke of Y axis (must be equal or lesser than Y max mechanical travel).

Max mechanical travel: setup the max mechanical travel (traverse) limit.

2. Servo Z Parameter

Outside mold safety area: the end of servo Z outside mold.

Inner mold safety area: the begins of servo Z inner mold.

Max servo travel: the max traverse stroke of servo Z, this parameter must equal or lesser than “max mechanical travel”.

Max mechanical travel: the max mechanical traverse limit of servo Z.

3. Speed Parameter

Y max speed: Y servo max speed.

Y servo acceleration: the faster acceleration speed, the shorter acceleration time.

Y servo deceleration: the smaller deceleration, the shorter acceleration time.

Z max speed: Z servo max speed.

Z servo acceleration: the faster acceleration: the faster acceleration speed, the shorter acceleration time.

Z servo deceleration: the smaller deceleration, the shorter acceleration time.

4.13 Setup System Parameter

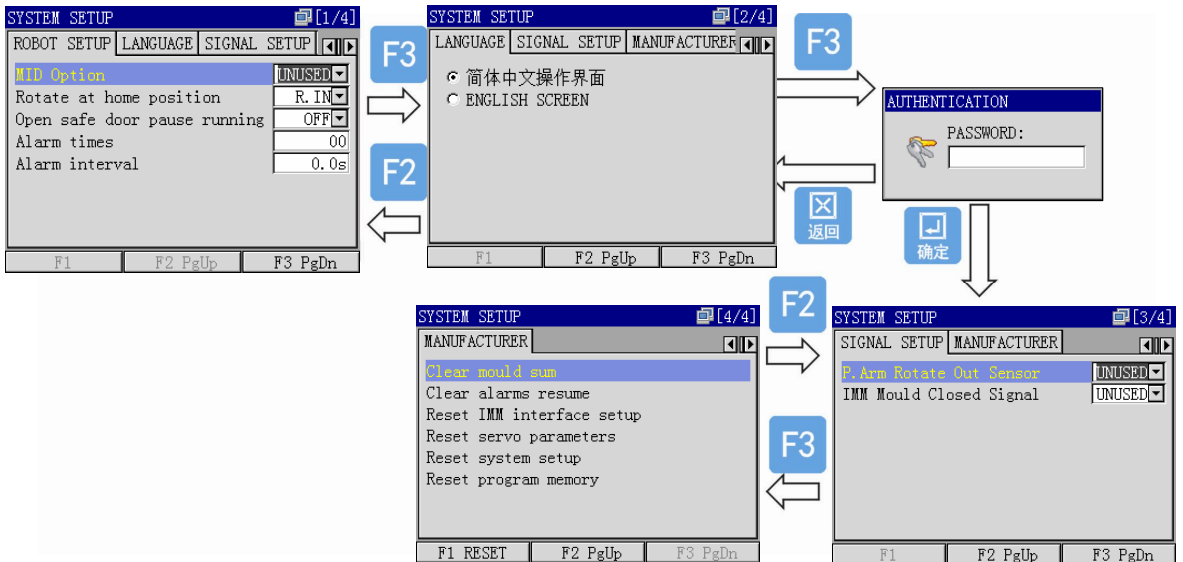

Press to input password.

Press to confirm password.

Press to back to last page.

Robot setup page:

Press to select options.

Press to page down.



Press : Increase value when modifying parameter value; Change settings when modifying parameter.

Press : Decrease value when modifying parameter value; Change settings when selecting options.

Press to save and back to last page.

Press  to give up modifying and back to last page.

User interface setting page:

Press   to change language.



: page up

: page down

: save and back to last page

: give up modifying and return to last page.

Manufacturer setting page:

Press   to select options.

: carry on operation

: page up

: save and return to last page

: give up modifying and return to last page

Robot parameters:

Rotate at home position: Set main arm rotates vertical or horizontal when it is at home position.

Open safe door pause running: Setup system whether pause auto running while the safe door is opened.

Alarm times: Set the alarm buzz times. The minimum is 0, means no alarm buzz. The maximum is 99.

Alarm interval: The time between 2 alarm buzz. The minimum is 0s and the maximum is 9.9s.

Signal configuration:

P.Arm (main arm) Advance Sensor: setup Main Arm Forward Sensor to use or not use.

P.Arm (main arm) Return Sensor: setup Main Arm Backward Sensor to use or not use.

P.Arm (main arm) Rotate Out Sensor: setup Main Arm Rotate Out Sensor to use or not use.

R.Arm (sub-arm) Descend Sensor: setup Sub-arm Down Sensor to use or not use.

R.Arm (sub-arm) Advance Sensor: setup Sub-arm Forward Sensor to use or not use.

R.Arm (sub-arm) Return Sensor: setup Sub-arm Backward Sensor to use or not use.

IMM Mold Close Signal: setup IMM Mold Close Signal to use or not use.

Manufacturer options:

Clear mold sum: Clear mold sum produced in auto running mode.

Clear alarms resume: Clear system alarm history.

Reset IMM interface setup: Restore IMM interface parameter to default settings.

Reset servo parameters: Restore servo parameter to default settings.

Reset system setup: Restore system setups to factory settings.

Reset Program Memory: Reset Teach Program memory.

4.14 Current Alarms and Alarm Resume

Current alarms:

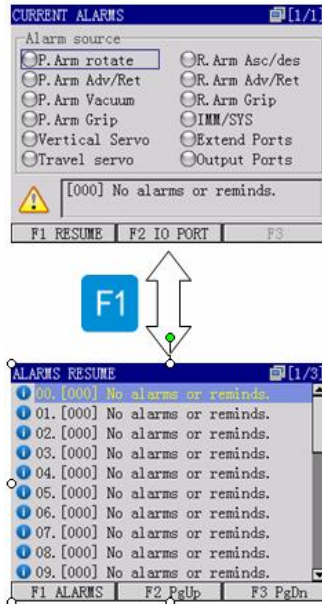

Press to select alarm type.

Press into alarms resume page.

Press into IO port monitor page.

Press return to last page.

Alarms resume:

Press into current alarms page.

: page up

: page down

Press return to last page.

4.15 System Information

Press / return to last page.

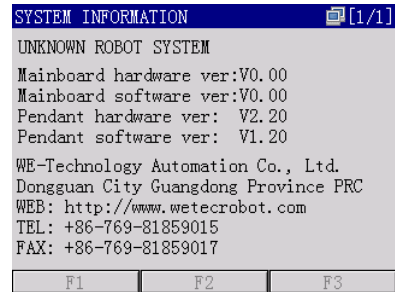

4.16 Teach Mode

4.16.1 Enter Teach Mode

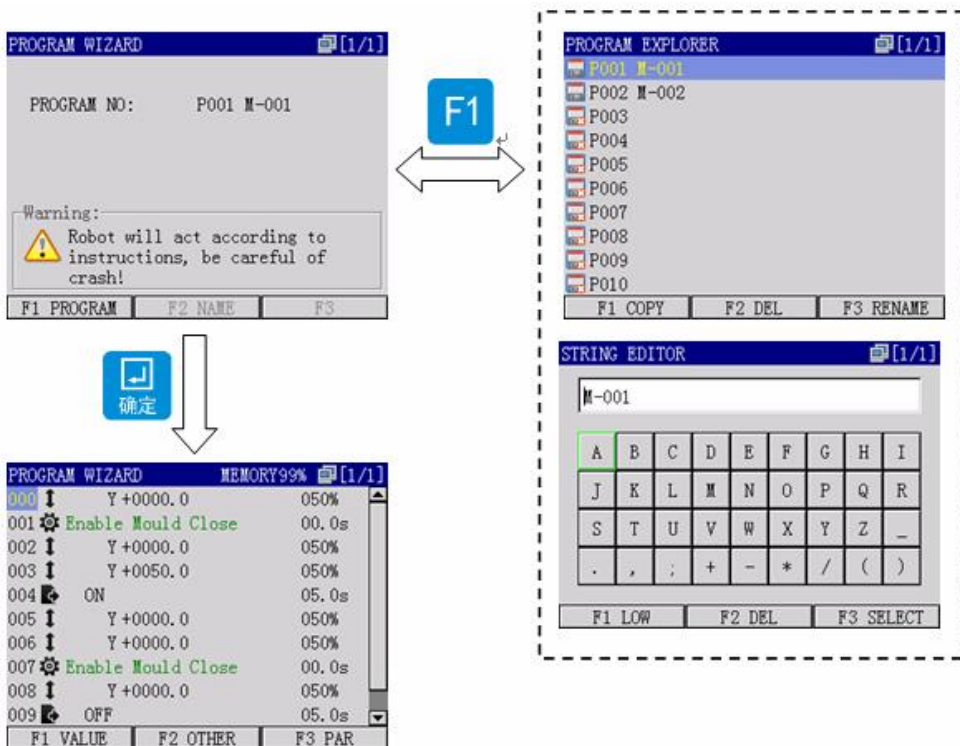

: select program.

: rename teach program.

: enter teach program page.

: give up teach program and return to last page.

4.16.2 Insert Actions

Servo actions:



: servo axis move up/down (Y and Z servo), or servo axis forward/backward.



: servo axis traverse in or out.



: select servo control mode after inserting servo actions.



: adjust servo speed after inserting servo actions.

After inserting servo actions, press / to choose servo Y or X.

After inserting servo actions, press / to choose servo traverse (Z) axis.

Press to confirm servo actions record, cursor will move to next record.

Arm actions:



:
 If main arm in horizontal state, press this key will rotate vertical .
 If main arm in vertical state, press this key will rotate horizontal .





:
 If main arm in forward state, press this key will move backward . (Servo X)
 If main arm in backward state, press this key will move forward . (Servo X)
 If main arm in up state, press this key will move down . (Servo Y)
 If main arm in down state, press this key will move up . (Servo Y)





:
 If main arm in vacuum on state, press this key will vacuum off .
 If main arm in vacuum off state, press this key will vacuum on .





If main arm in grasp on state, press this key will grasp off 
 If main arm in grasp off state, press this key will grasp on 





If sub-arm in up state, press this key will move down 
 If sub-arm in down state, press this key will move up 



If sub-arm in forward state, press this key will move backward 
 If sub-arm in backward state, press this key will move forward 



If sub-arm in grip on state, press this key will grip off 
 If sub-arm in grip off state, press this key will grip on.



Press  to confirm arm actions and edit delay time.

Press  to confirm arm actions record, cursor moves to next record.

Loop actions:

Press  into Select Loop Area page.

Insert loop area page:

Press   to select sub-programs.

Press  to insert selected loop.

Insert extend IO:

In “teach mode” page, press  to edit extend

In “Extend IO Port Editor” page, press   to select options.

: clear IO port when selecting port.

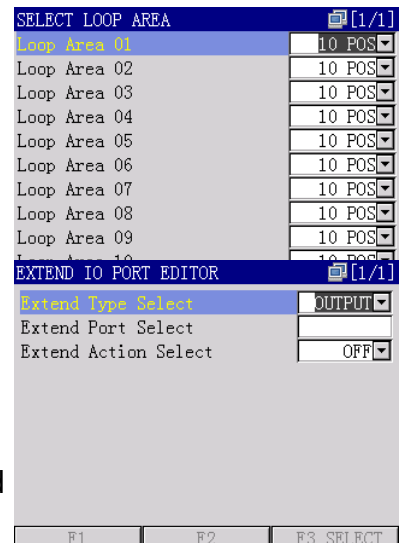

F3: enter port choose page.

ON+ INSERT **OFF- DELETE**:

Setup actions when setting port.

Edit value when setting delay time.

Press to set delay time, move cursor.

Press to input value.

Press to confirm extend IO action and back to teach program page, insert extend IO actions.

Press to give up extend IO editor and back to teach program page.

User value editor:

In teach program page, press **F1** enter “user value editor” page.

In “user value editor” page, press to select options.

F3: confirm selection.

: insert value action ,

confirm value action and return to teach program.

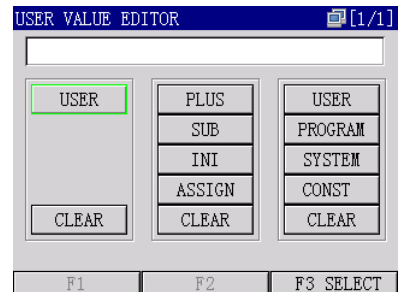

: Cancel the user value edit and return to teach program page.

The system can define 32 user variables. The names of the variables are from U000 to U032. Each variable has a minimum value 0 and a maximum value 65535. User variables are designed for counter function, usually for program branch control, for example, condition control or recycle control.

Besides the user variables, program variables and system variable are

supported. The two kinds of variables can only be read, can't be written. See the appendix for details about system variables and program variables.

User variables can execute the following operations:

PLUS: User variables value adds 1 after one execute; this is unary operation and has no parameter.

SUB: User variables value subtracts 1 after one execute; this is unary operation and has no parameter.

INI: Initial operation execute only once when in automatic mode. This is for assign value for the variable. This is binary operation, variables can be initialed as a user variable, program variable, system variable or a constant.

ASSIGN: User variable will be assigned a certain value after execute one ASSIGN. This is binary operation, variables can be assigned as a user variable, program variable, system variable or a constant.

Insert branch:



In teach program page,

press  into "Branch Instruction Editor" page.

In "Branch Instruction Editor" page,

press  to select options.

Press  to confirm selection.

Press  to confirm inserting and return to teach program page, inserting program action .

Press  to give up program edit and return to teach program.

More details see chapter 4.16.3 Program Branch Control.

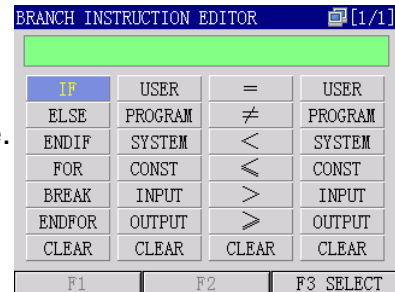

Insert IMM action:

In teach program page,

Press into IMM signal page.

In IMM signal page, press to select signal.

Press to confirm IMM actions and return to program page, insert IMM actions .

Press give up selection and return to teach program page.

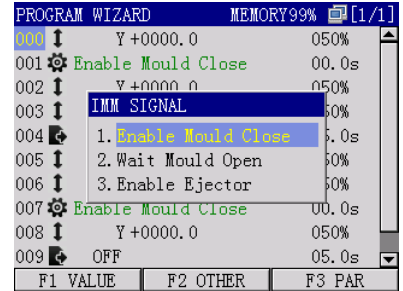

Insert others action:

In teach program page,

press into the others action page.

In the others action page, press to select other actions.

Press to confirm selection and back to teach program page, insert combine action /branch checking/combine end .

Press to give up selection and back to teach program page.

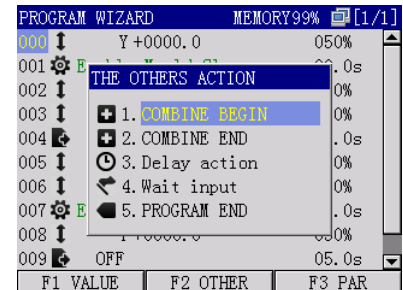

4.16.3 Program Branch Control

Conditional control:

Format of conditional control is as below:

```
IF [condition]
{ serial action A }
ELSE
{ serial action B }
ENDIF
```

Program will judge the condition firstly, if equals the condition, then execute serial action A. Otherwise, execute serial action B.

The conditional control can also have no ELSE, as below:

```
IF [condition]
{ serial action A }
ENDIF
```

Program will judge the condition firstly, if equals the condition, then execute serial action A. Otherwise, jump the serial action A, and execute the action after the conditional control.

The type of the condition is as below:

Variable Expression: Program will judge if the variable equal to, not equal to, greater than, greater than or equal to, less than, less than or equal to another variable or constant. The condition can also be a variable only, when the variable not equal to 0, satisfy the condition; otherwise, not satisfy the condition.

Input Port Expression: Condition can be an input port directly. When the input port has signal, then satisfy the condition. Otherwise, no input signal means not satisfy the condition.

Output Port Expression: Condition can be an output port directly. When the output port has signal, then satisfy the condition. Otherwise, no output signal means not satisfy the condition.

Note: The Condition cannot be a constant.

Recycle Control:

The format of recycle control is as below:

```
FOR [recycle times]
{ serial action A }
ENDFOR
```

Serial action A will repeat times as the program setting.

Two types of recycle times:

Constant: Serial action will repeat the times as the program setting.

Variable: The recycle times is appointed by the variable. The variable can be user variable, or the program variable, or system variable.

Note: Repeat times cannot be the input/output port.

4.17 Program/System Value

Program Value	
No.	Definition:
V000	Cycles in auto mode.
V001	Production plane
V003	Reject alarm
System Value	
No.	Definition:
S000	Production cycles in robot auto running mode.
S001	Servo Y max mechanical stroke
S002	Servo Z max mechanical stroke
S003	Servo Y max software stroke
S004	Servo Z max software stroke
S005	Servo Y current position
S006	Servo Z current position
S007	Servo Y standby in mold
S008	Servo Z standby outside mold
S009	Servo Z standby in mold
S010	Tick value (system from start to current, unit 0.1 second)

5. Alarm Message

No.	Alarm Message Details
000	No alarms or reminds.
001	Sub-arm action invalid.
002	Main arm action invalid.
003	IMM action invalid.
004	Conditional invalid.
005	Robot running invalid.
006	System invalid.
007	Parameter invalid.
008	Order invalid.
009	Extend invalid.
010	Program number invalid.
011	Order format wrong, cycle not end.
012	Order format wrong, cycle not begin.
013	Order format wrong, conditional not end.
014	Program order not ends.
015	More than one location instruction in combine action.
016	More than one rotates instruction in combine action.
017	More than one runner arm instruction in combine action.
018	The instructions in combine more than 10.
019	Some instructions can not in combine action.
020	Combine action format error. Without end combine.
021	System value cannot be written.
022	Program value cannot be written.
023	The in port value cannot be written.
024	The out port value cannot be written.
025	The user value beyond range.
026	Loop position invalid.
031	No IMM auto running signal.
032	No IMM safety door signal.
033	Production schedule has completed.
034	Reject exceed standard.
035	Can not change current program while system in auto status.
036	Can not change running status while system in manual or error status.
037	Can not change system status while system in error status.
038	Can not change system status while system is running.
039	Unable mold close while sub-arm isn't in safe position.
040	Unable mold close while main arm isn't in safe position.
041	Unable product rotate while main arm in mold.
042	Sub-arm can't down while robot arm isn't in safe area.
043	Without MOP (mold open) signal, sub-arm can't down.
044	Without middle mold open signal, sub-arm can't down.
045	No Y home position signal.
046	System can't enter auto status while robot outside mold.
047	Hasn't selected current program.
048	No extend input signal.
049	Robot arm must rotate horizontal while robot at home position.

050	Robot arm must rotate vertical while robot at home position.
051	Servo must return to home position at first.
052	Servo Z can't run while main arm isn't at up position.
053	Servo Z can't run while sub-arm isn't at up position.
054	No mold open signal, Y can't move.
055	No middle mold signal, Y can't move.
056	Y can't move while Z not in safe area.
058	Servos can't run at the same time while adjust safe positions in manual mode.
059	Sub-arm is not on up position.
060	System needs maintenance by manufacturer.
061	Servos can't insert running while system in manual status.
062	The current program is empty and system can't enter auto status.
063	System is busy, please hold on.
064	Instruction error, current program can't execute continually.
065	Can't delete current program.
066	Program stopped while safe door is opened.
067	System main board error, please contact with manufacturer.
068	Main arm can't down while rotate vertical.
070	The next position of Y servo will exceed the max software distance.
071	The next position of Z servo will exceed the max software distance.
072	Robot in mold safe area but no safety signal.
073	Robot outside mold safe area but no safety signal.
075	Main arm in above safe area but no safety signal.
076	Y08 overload, power short circuit or over temperature.
077	Y09 overload, power short circuit or over temperature.
078	Y10 overload, power short circuit or over temperature.
079	Y11 overload, power short circuit or over temperature.
080	Y12 overload, power short circuit or over temperature.
081	Y13 overload, power short circuit or over temperature.
082	Y14 overload, power short circuit or over temperature.
083	Y15 overload, power short circuit or over temperature.
084	Y16 overload, power short circuit or over temperature.
085	Y17 overload, power short circuit or over temperature.
086	Y18 overload, power short circuit or over temperature.
087	Y19 overload, power short circuit or over temperature.
088	Y20 overload, power short circuit or over temperature.
089	Y21 overload, power short circuit or over temperature.
090	Y22 overload, power short circuit or over temperature.
091	Y23 overload, power short circuit or over temperature.
128	No main arm rotate vertical signal.
129	Main arm vertical but with horizontal signal.
130	No main arm rotate horizontal signal.
131	Main arm rotate horizontal but with vertical signal.
132	No sub-arm down finished signal.
133	Sub-arm down but with up signal.
134	No sub-arm up finished signal.
135	Sub-arm up but with down finished signal.
136	No sub-arm forward finished signal.

137	Sub-arm forward but with backward finished signal.
138	No sub-arm backward finished signal.
139	Sub-arm backward but with forward signal.
143	Servo Y alarm.
144	Servo Y not ready.
145	No servo Y signal.
146	Servo Z alarm.
147	Servo Z not ready.
148	No servo Z signal.
149	IMM emergency stop.
150	Robot emergency stop.
151	Low air pressure, please check it.
152	Mold open signal disappeared while sub-arm in mold.
153	Middle mold signal disappeared while sub-arm in mold.
154	Mold open signal disappeared while main arm in mold.
155	Middle mold signal disappeared while main arm in mold.
158	Servo Y up to limited.
159	Servo Y down to limited.
160	Servo Z traverse in limited.
161	Servo Z traverse out limited.
162	Y on 0-position but no home position signal.
163	Servo axis location overtime.
164	Main arm forward but no signal.
165	Main arm backward but with forward signal.
166	No main arm backward signal.
167	Main arm backward but with forward signal.
168	No main arm vacuum on signal.
169	Main arm grasp but no signal.
170	Sub-arm grip but no signal.
171	Main arm vacuum off but with on signal.
172	Main arm grasp off but with on signal.
173	Sub-arm grip off but with on signal.
174	Invalid axis.

6. Maintenance

6.1 General

Please observe the prescribed maintenance intervals. Proper maintenance ensures trouble-free functioning of the robot. Proper maintenance is necessary in order that the warranty be fully enforceable.

Maintenance should be performed by qualified personnel only.



Maintenance responsibility for safety equipment becomes the responsibility of the system operator once he accepts the robot.



Please note, in particular, that safety instructions marked with  must be observed according to regulations so that full functionality of this equipment can be guaranteed. Before carrying out maintenance work, and entering the safety zone of the robot, the main switch and compressed air must be disconnected and the compressed air system must be evacuated.

6.2 Lubrication Requirements

Remove the old grease from the guide shafts and scraper rings of the bearing using a cloth. Then apply the new grease to the guide shafts using a brush.

As well as all roller bearing greases according to DIN 51825.

6.3 Maintenance Cycle

In accordance with the maintenance cycle, make work in the best way.

Daily Maintenance	Monthly Maintenance	Quarterly Maintenance
<ol style="list-style-type: none"> 1. Swab robot. 2. Filter drainage. 3. Check the air pressure. 4. Check bolt connection robot and injection molding machine whether tighten. 5. Check all block settings whether tightened. 	<ol style="list-style-type: none"> 1. Use air clean filter. 2. Check the screws on all part whether tightened. 3. Confirm whether the pipelines break or loose. 4. Check and adjust the operating speed. 	<ol style="list-style-type: none"> 1. Brush oil on to the axis

7. Assembly Diagram

7.1 Traverse Unit

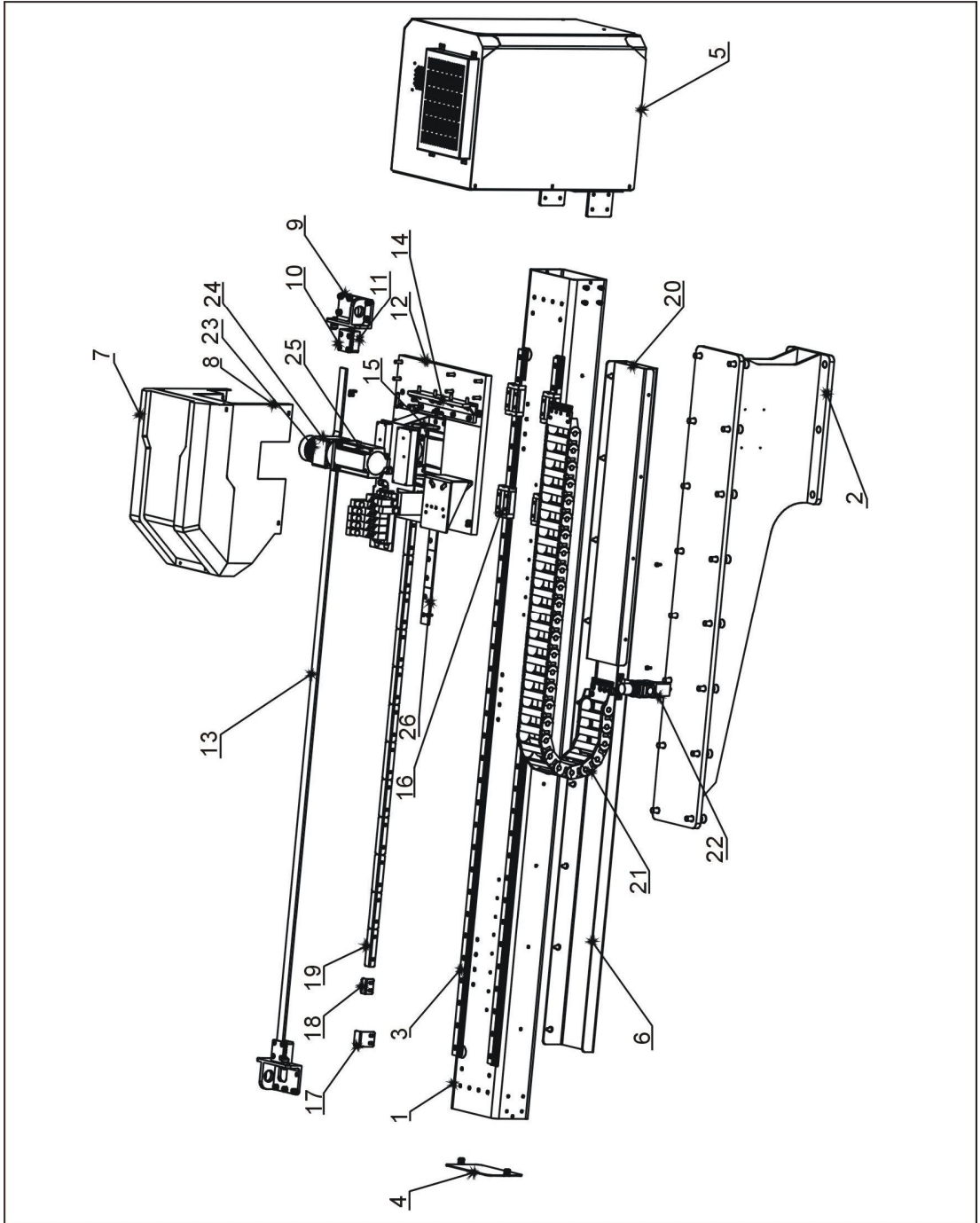

Picture 7-1: Traverse Unit

7.2 Parts List

Table 7-1: Traverse Unit Parts List

No.	Name	Part Number
		ST2-Y900-1400HT
1	Traverse profile	BH73140008610
2	Base	BH10591100010
3	linear guiderail	YW31519000000
4	Cover of traverse beam	BL81020600020
5	Cover of control box	BH81290003250
6	Supporting frame of traverse drag chain	BL70371420020
7	Cover of sliding seat	BL81000206120
8	Sliding seat 03	
9	Belt fixing frame	BL71010900020
10	Belt splint connecting piece	BL70110100020
11	Belt pressure plate	YW09564900110
12	Sliding seat 01	BH73031802110
13	Traverse belt	YR00082500100
14	Crosswise fixing aluminium	
15	Motor supporting frame	BH10155000010
16	Slider	YW31250000000
17	Limit sensor panel	BL69335000020
18	Origin sensor panel	BL69363000020
19	Safety sensor panel in mold	BL69002200020
20	Cover of traverse cable	BL73714001320
21	Traverse drag chain	YE68225000900
22	Filter regulator	YE30301000000
23	Synchronous wheel	YW08550200200
24	Speed reducer	YM50750750000
25	Servo motor	
26	Safety sensor panel outside mold	BL81023900020

*means possible broken parts. **means easy broken part, and spare backup is suggested.

Please confirm the version of manual before placing the purchase order to guarantee that the item number of the spare part is in accordance with the real object.

7.3 Main Arm Unit

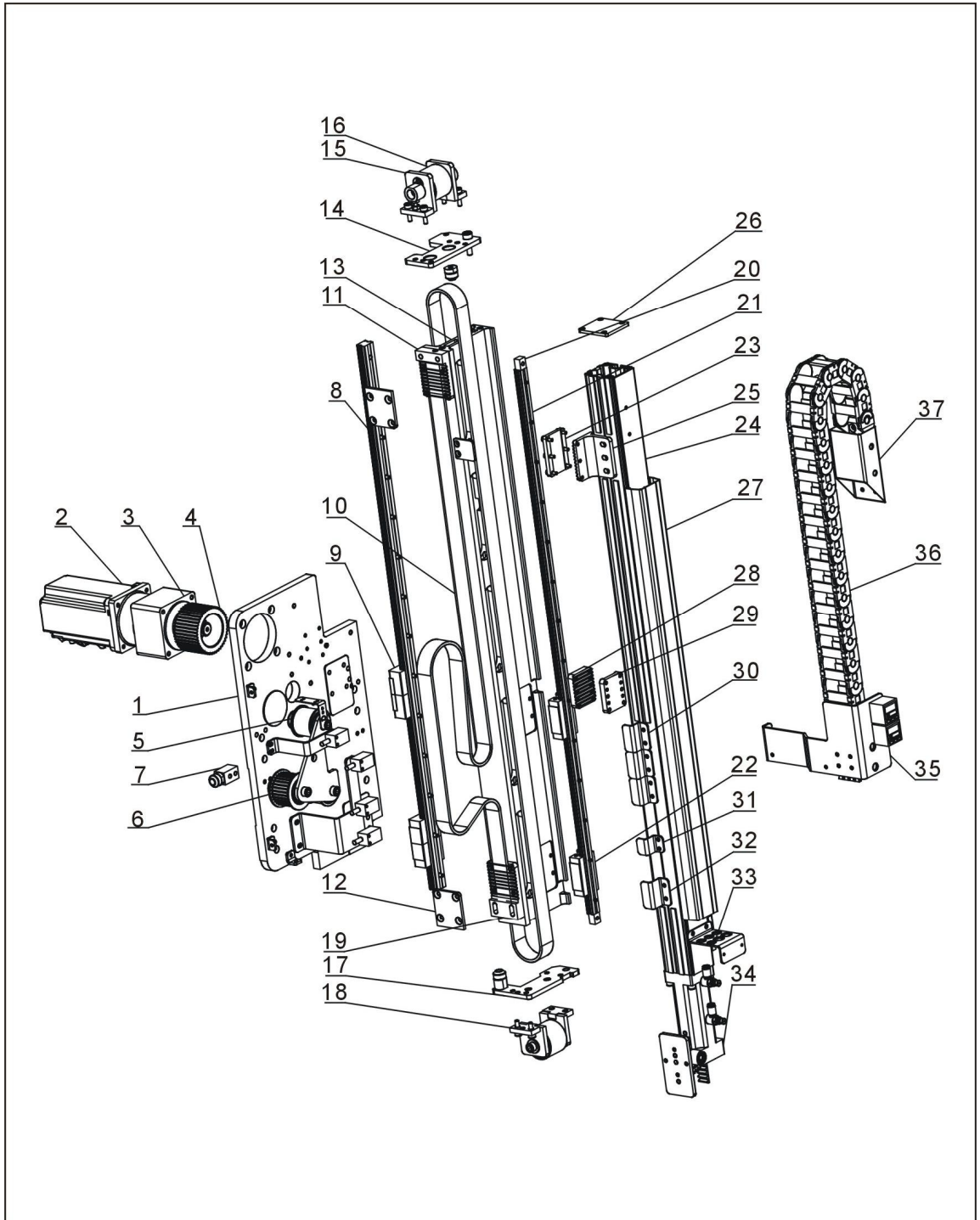

Picture 7-2: Main Arm Unit

7.4 Parts List

Table 7-2: Main Arm Parts List

No.	Name	Part Number
		ST2-Y900-1400HT
1	Mounting plate of main arm	BH81020100040
2	Servo motor	-
3	Speed reducer	YM50750750000
4	Arm driving wheel(up/down)	YW08000200100
5	Belt pulley	BH91050700010
6	Main arm driven wheel (up/down)	YW08533200100
7	Limit fixing plate	BH91051500040
8	Linear guiderail 20	YW31008202000
9	Slider 20	YW31204000000
10	Synchronous belt	YR00052500100
11	Belt pressure plate 1	BH81021700010
12	Belt splint connecting piece	BL70110100020
13	Main arm profile 1	BH81290000110
14	Main arm belt fixing plate(above)	BL81020900220
15	Pulley fixing plate 3	BL81022400220
16	Tension pulley	BH81021100010
17	Main arm belt fixing plate(below)	BL81020800220
18	Pulley fixing plate 2	BL81021300220
19	Belt pressure plate 2	BH81021600010
20	Slider limit block	BL70300000020
21	Linear guiderail 15	YW31008200000
22	Slider 15	YW31151100000
23	Synchronous belt pressure plate (down)	BH81022300010
24	Main arm profile 2	-
25	Belt pressure plate (down)	BH81021500010
26	Cover of main arm	BL81000200020
27	Main arm aluminium cover	BH81290000610
28	Belt fixing plate (up)	BL81022100220
29	Belt pressure plate (up)	BH81022200010
30	Upward safety sensor panel	BL81000200820
31	Origin sensor panel	BL81000200920
32	Limit sensor panel	BL81000201020
33	Spare supporting frame for air tube	BL70102600020
34	Flip cylinder	BH10550900020
35	Arm drag chain connector	BL81000200720
36	Main arm drag chain	YE60150000000
37	Main arm drag chain connector(up/down)2	BL77055000020

Please confirm the version of manual before placing the purchase order to guarantee that the item number of the spare part is in accordance with the real object.

7.5 Crosswise Unit

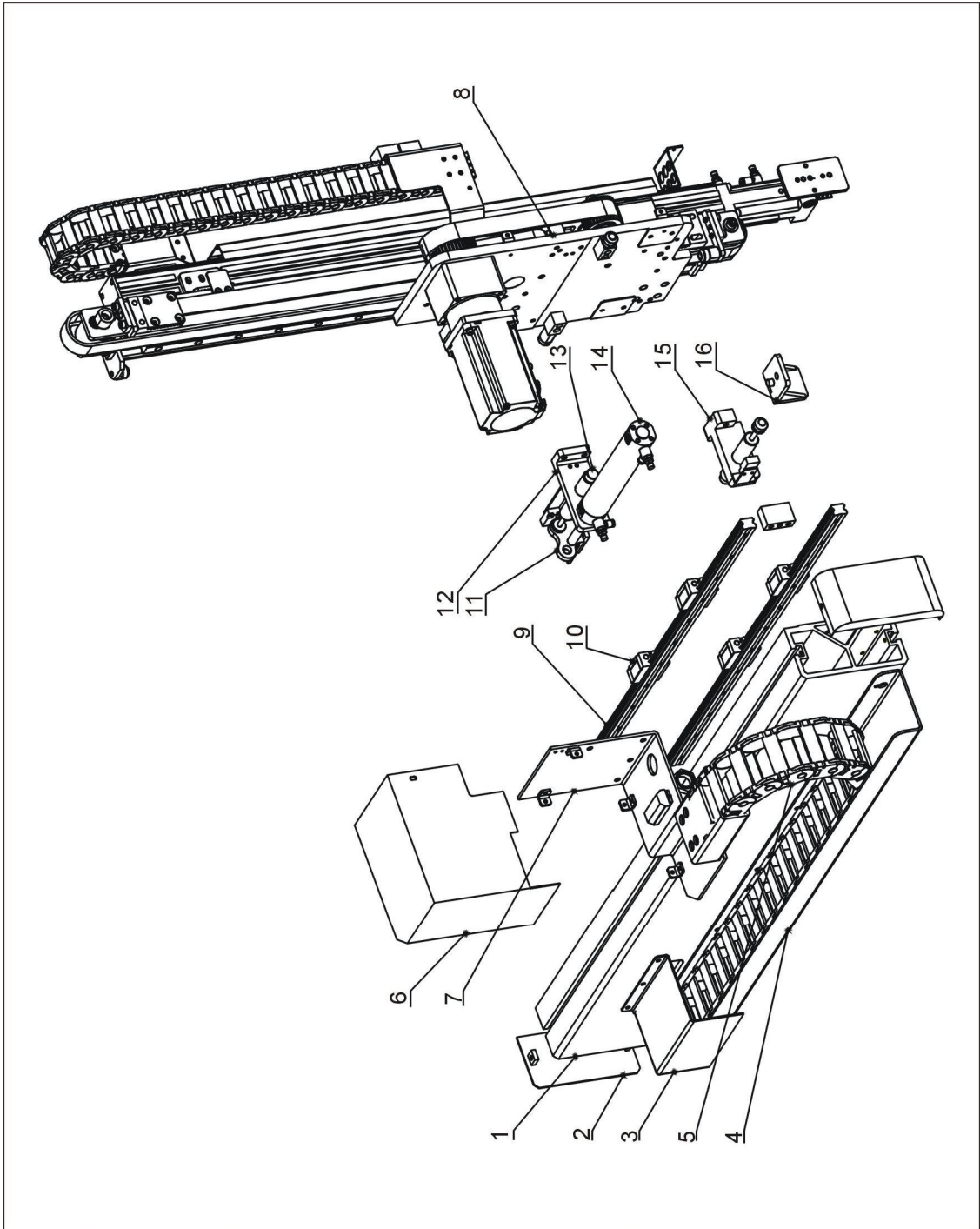

Picture 7-3: Crosswise Unit

7.6 Parts List

Table 7-3: Crosswise Parts List

No.	Name	Part Number
		ST2-Y900-1400HT
1	Crosswise beam	BH81290004210
2	Cover of crosswise arm	BL81020600120
3	Cover of crosswise drag chain	BL81020700020
4	Supporting frame of crosswise drag chain	BL81290000020
5	Crosswise drag chain	YE68250510000
6	Air tube transition base cover	BL81020800020
7	Air tube transition base	BL81020300020
8	Semi-finished main arm	
9	Linear guiderail	
10	Slider	YW31204000000
11	Crosswise fixing base	YW32200800000
12	Cylinder connecting plate	BH81020200110
13	Shock absorber	YW10203020000
14	Crosswise cylinder	YE30321500000
15	Shock absorber fixing block	BH72012200510
16	Crosswise arm limit stopper	BH72011800510

*means possible broken parts. **means easy broken part, and spare backup is suggested.

Please confirm the version of manual before placing the purchase order to guarantee that the item number of the spare part is in accordance with the real object.

8. Electric Control Chart

8.1 The Power Input Wiring Diagram

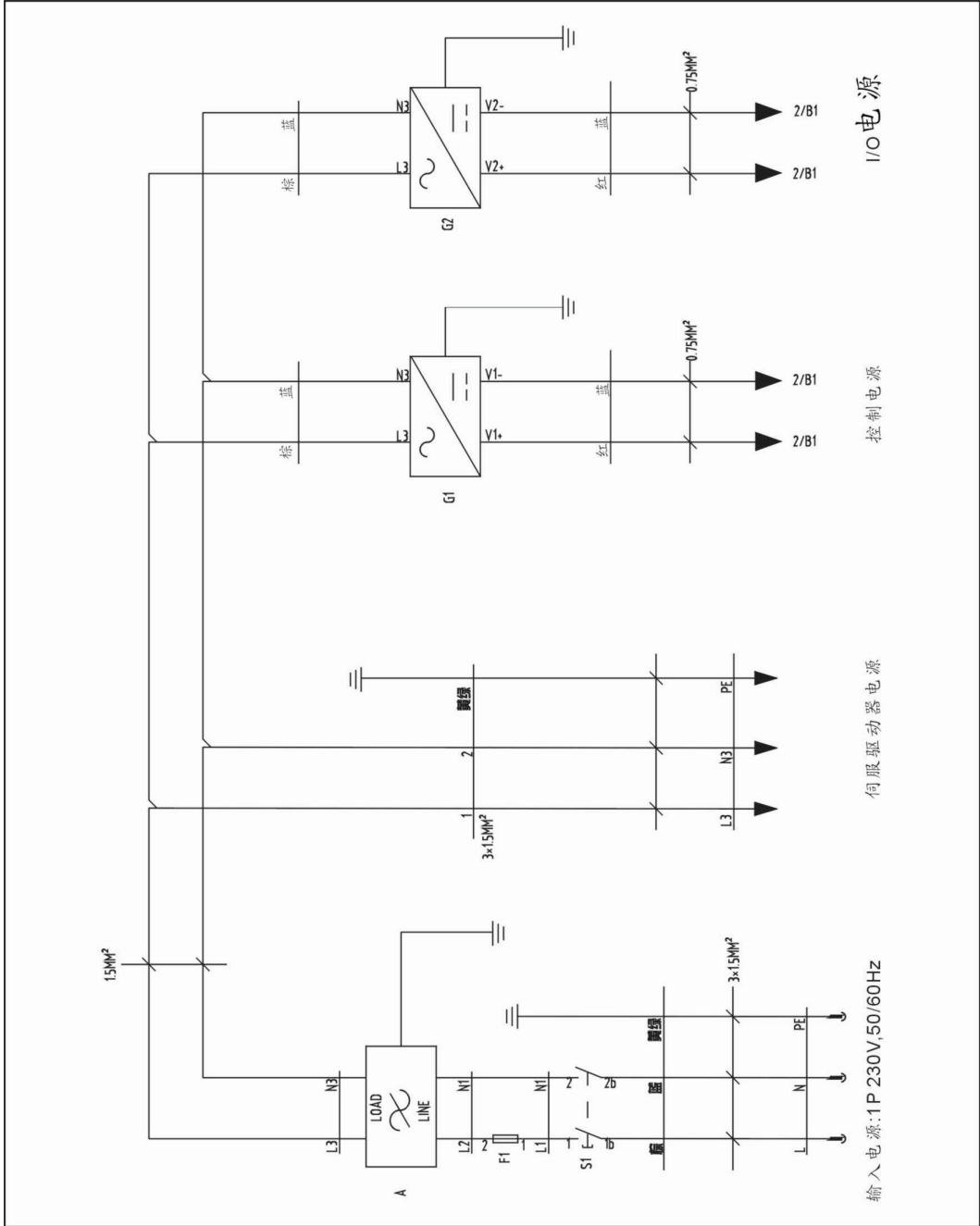

Picture 8-1: The Power Input Wiring Diagram

8.2 The Panasonic Servo Motor Wiring Diagram

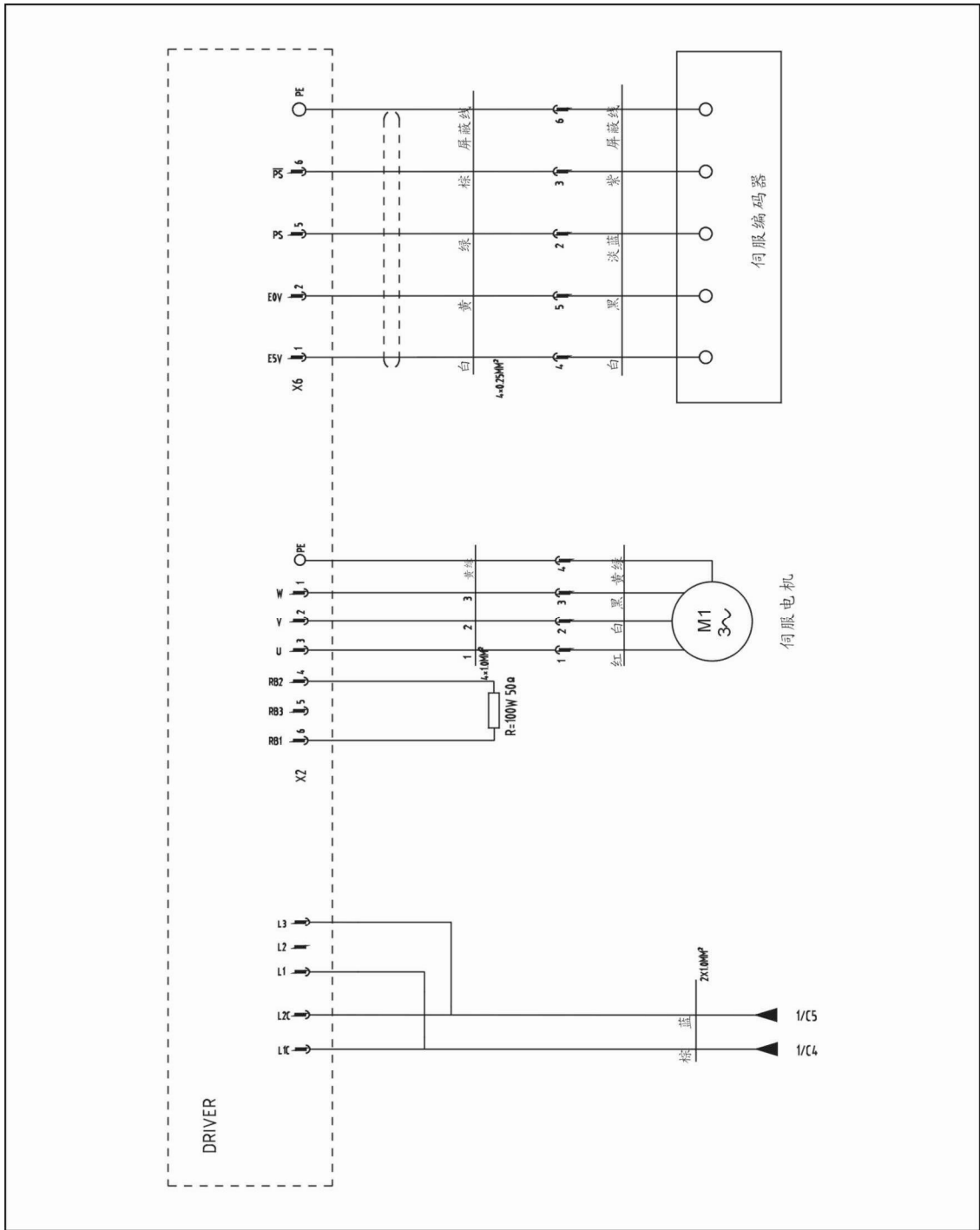

Picture 8-2: The Panasonic Servo Motor Wiring Diagram

8.3 The Panasonic Servo Motor and I/O Board Wiring Diagram

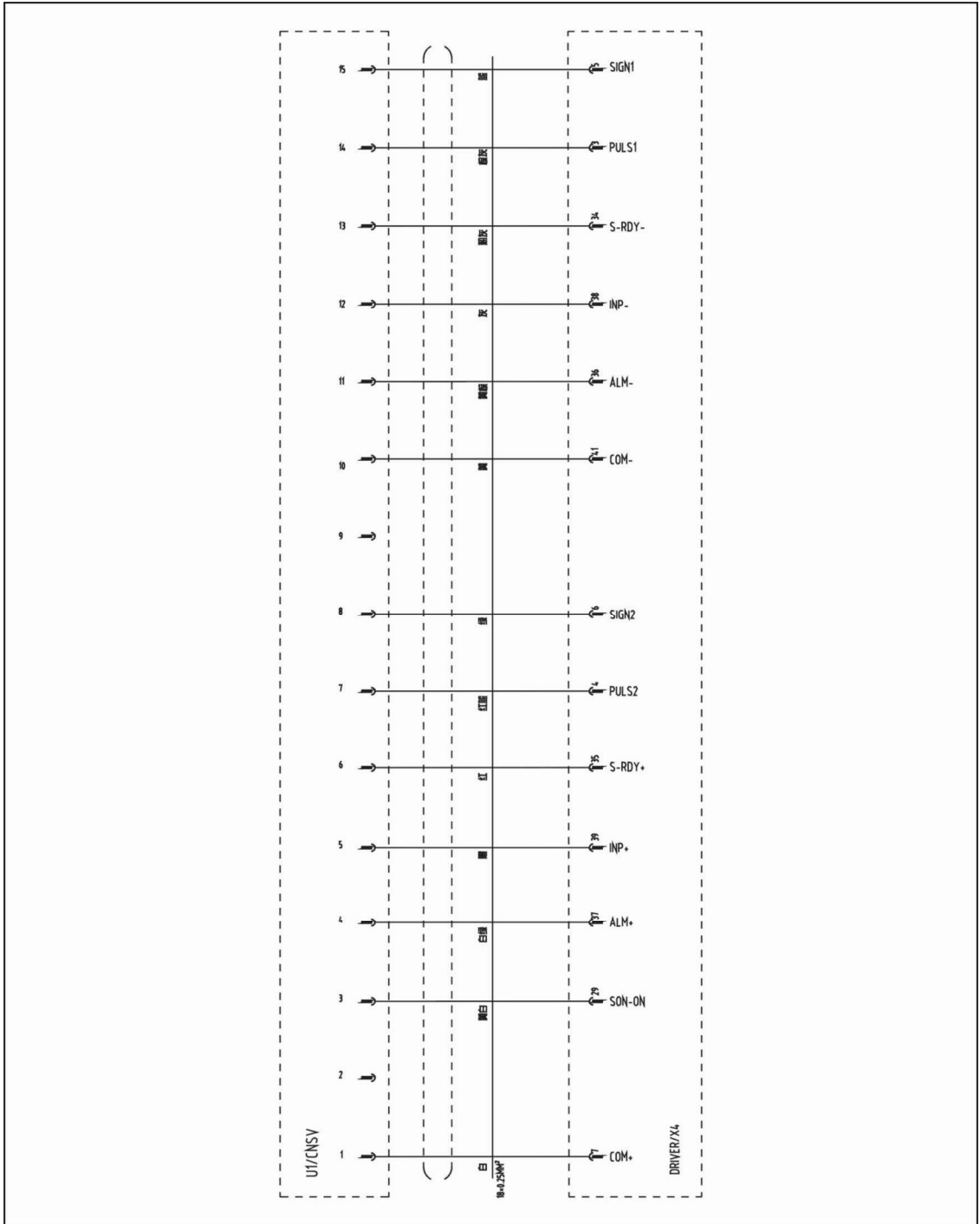

Picture 8-3: The Panasonic Servo Motor and I/O Board Wiring Diagram

8.4 The Delta Servo Motor and Servo Driver Wiring Diagram

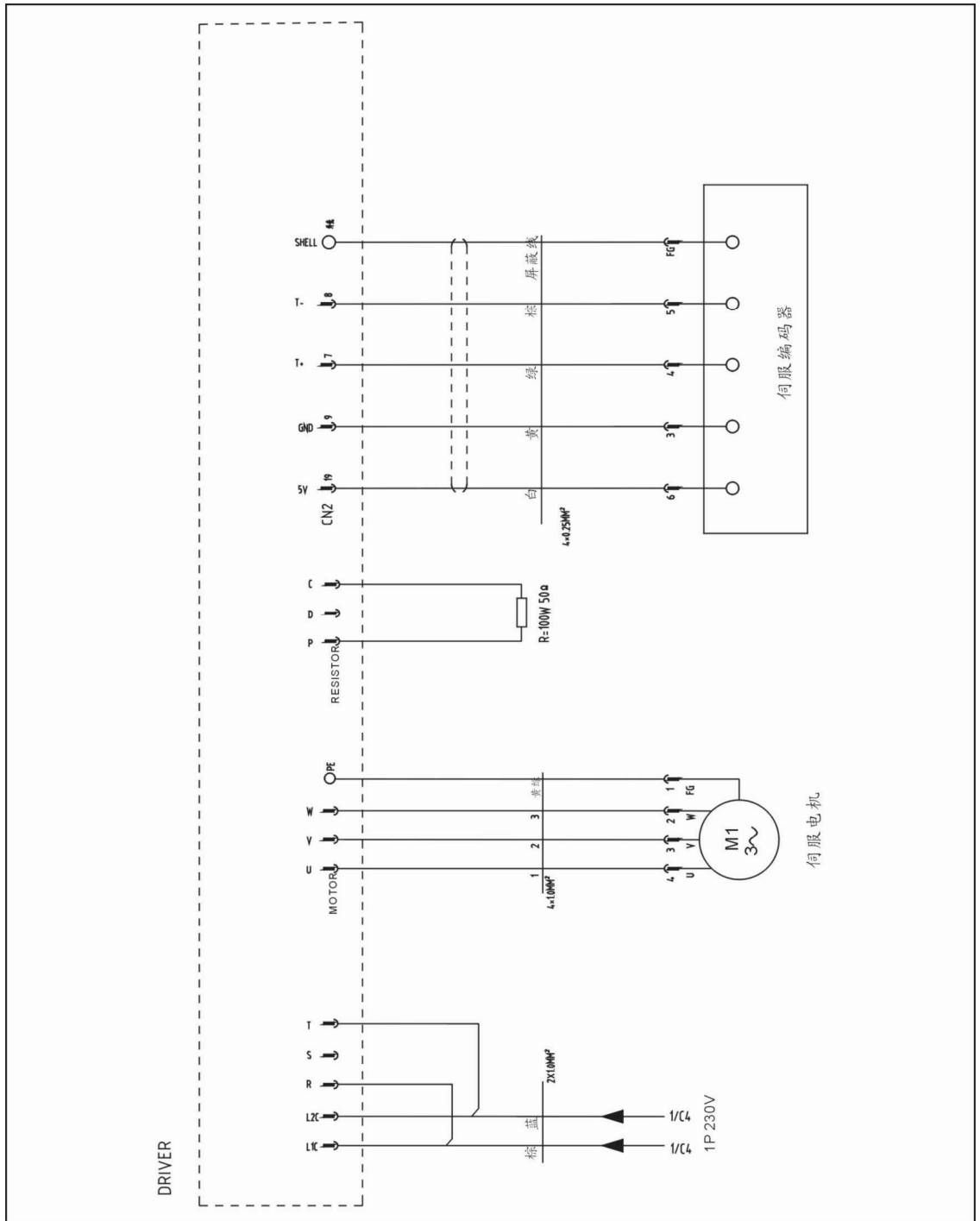

Picture 8-4: The Delta Servo Motor and Servo Driver Wiring Diagram

8.5 The Delta Servo Motor and I/O Board Wiring Diagram

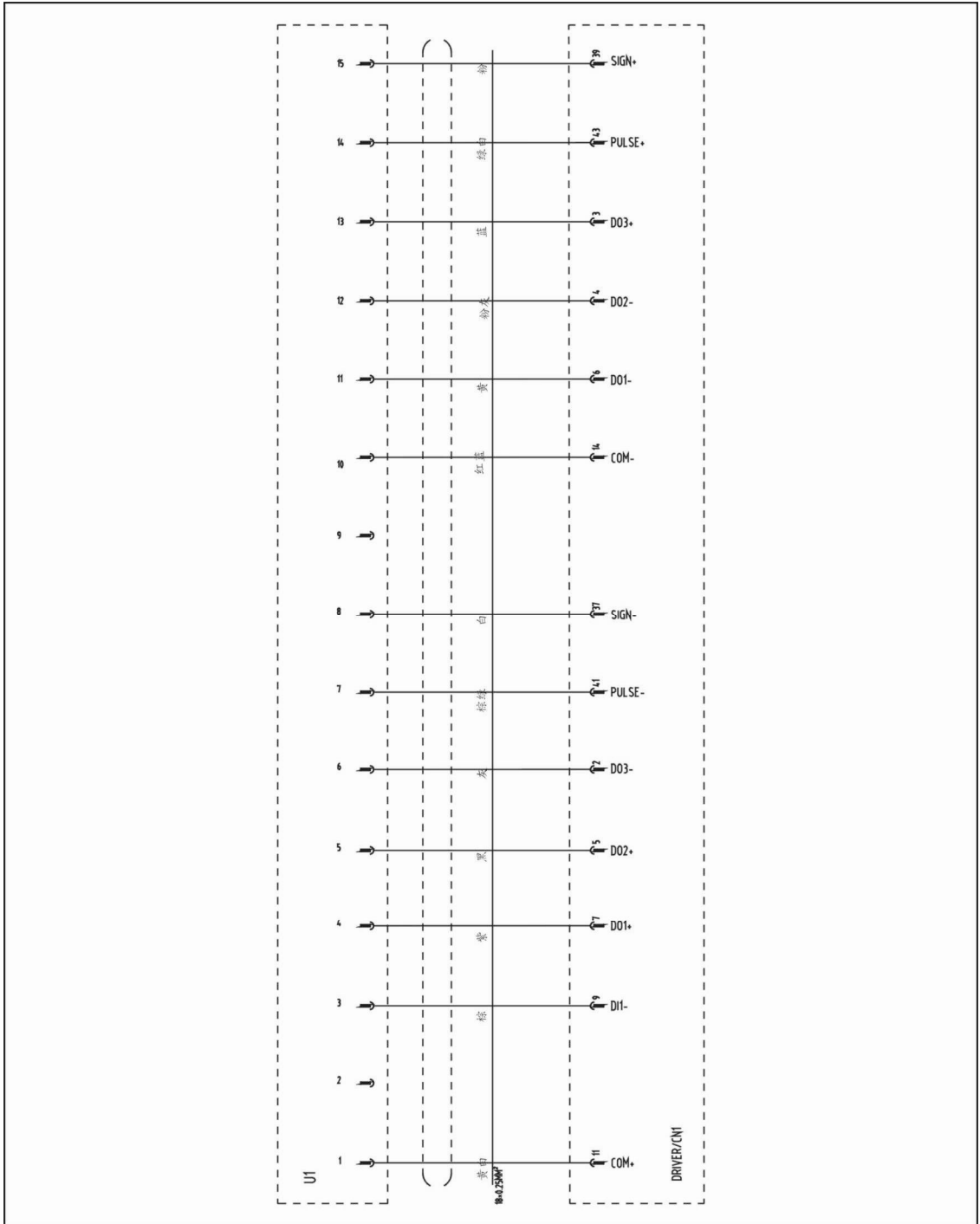

Picture 8-5: The Delta Servo Motor and I/O Board Wiring Diagram

8.6 The Cuinsico Servo Motor and Servo Driver Wiring Diagram

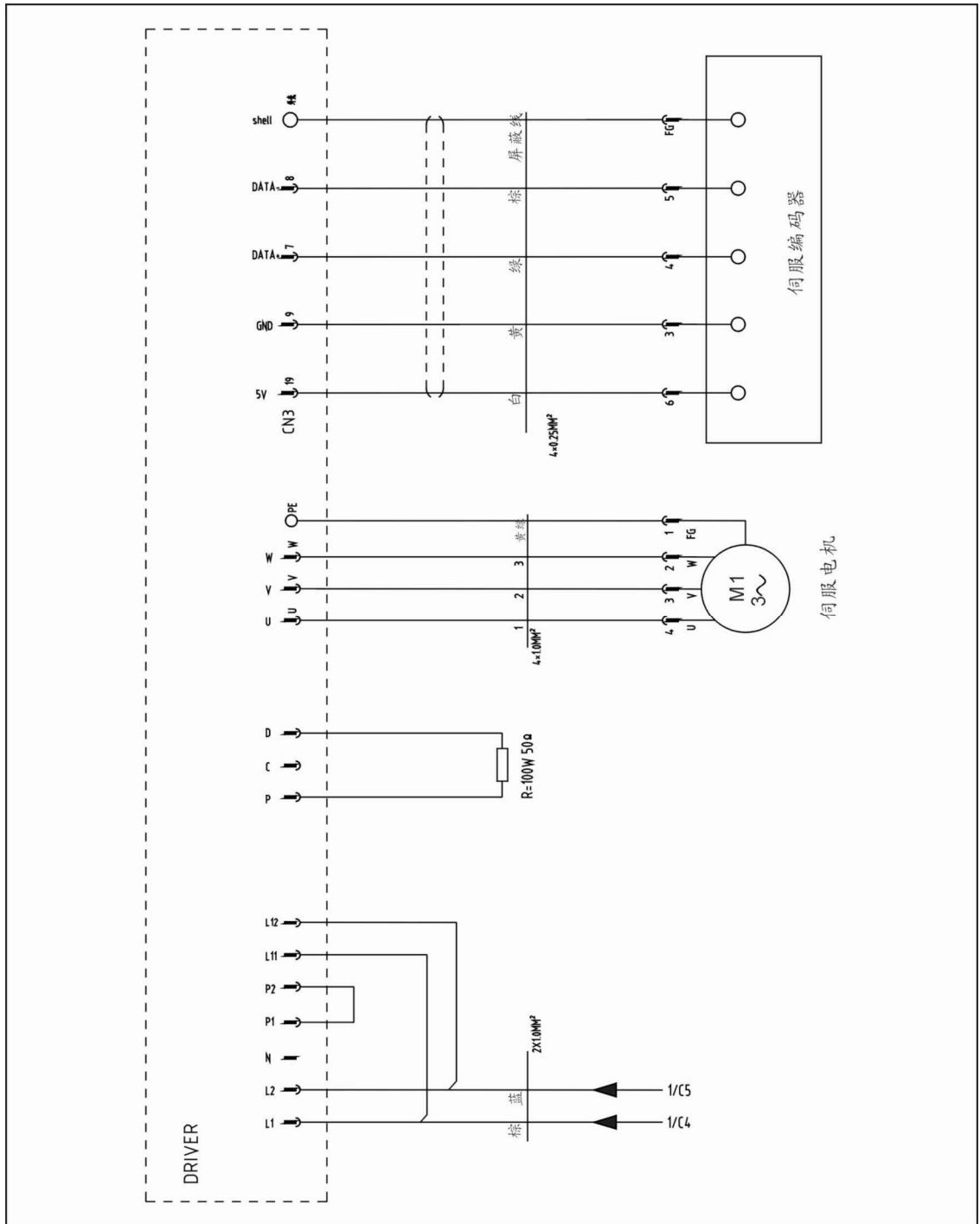

Picture 8-6: The Cuinsico Servo Motor and Servo Driver Wiring Diagram

8.7 The Cuinsico Servo Motor and I/O Board Wiring Diagram

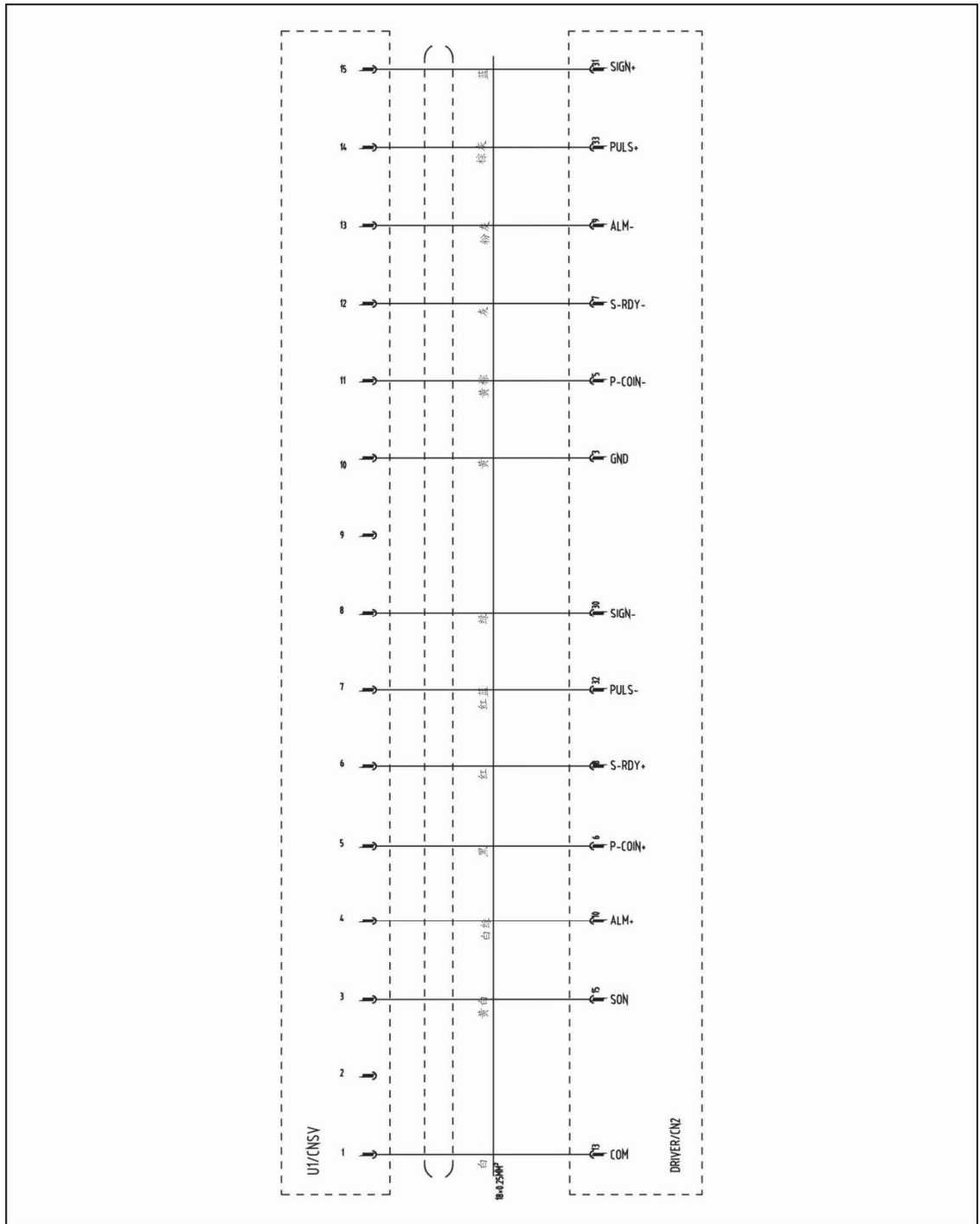

Picture 8-7: The Cuinsico Servo Motor and I/O Board Wiring Diagram

8.8 Z-axis I/O Board Wiring Diagram

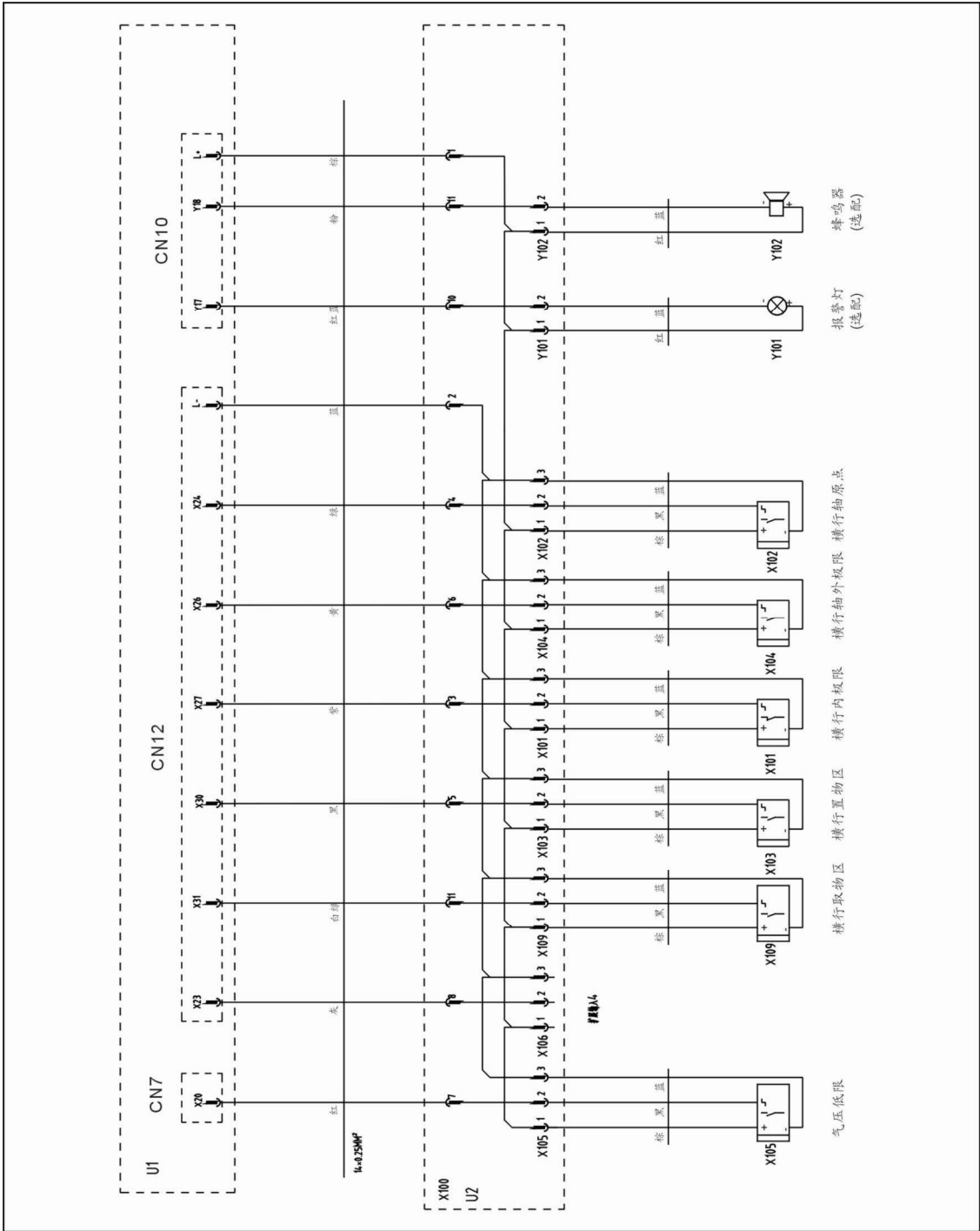

Picture 8-8: Z-axis I/O Board Wiring Diagram

8.9 Main Arm Wiring Diagram 1

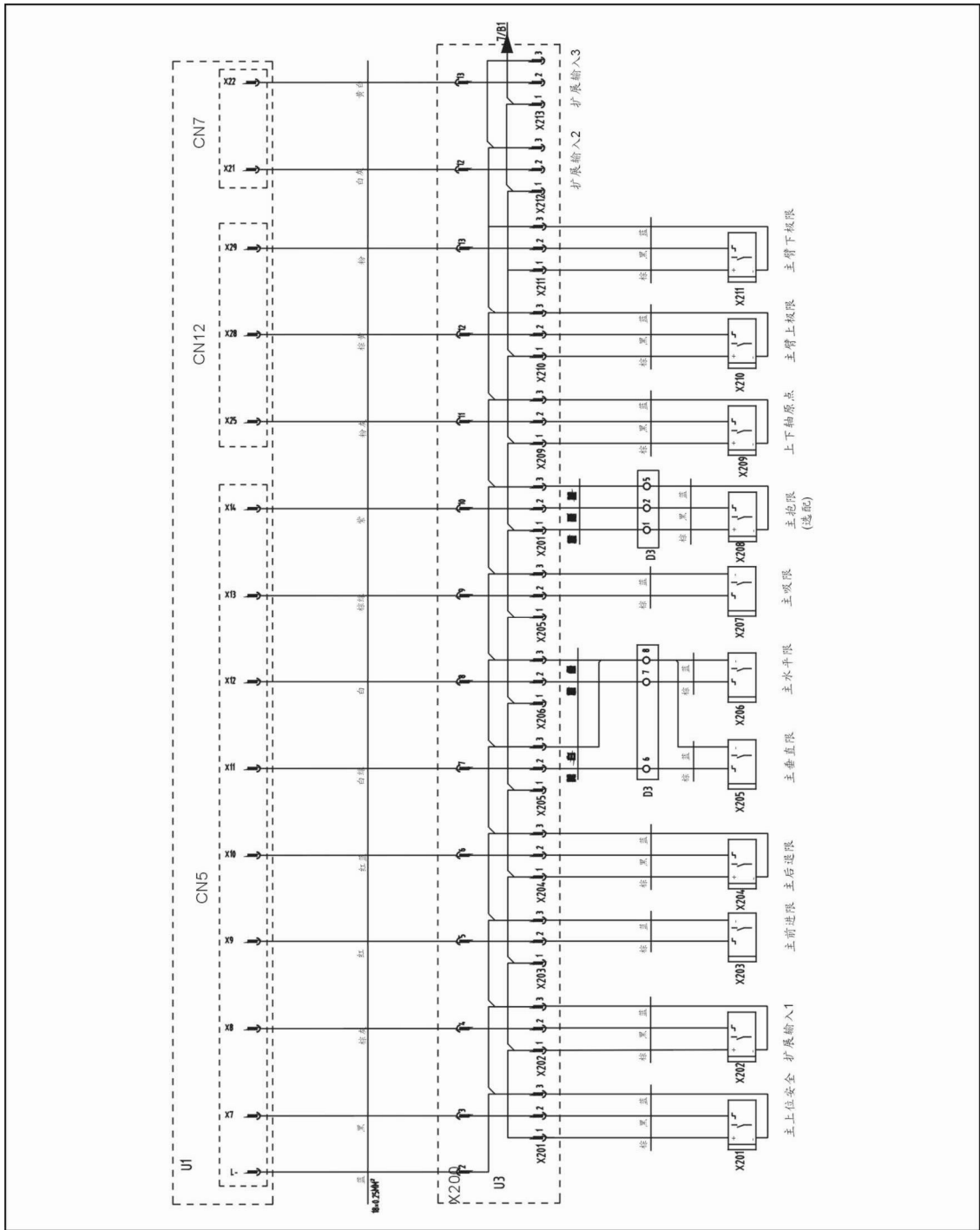

Picture 8-9: Main Arm Wiring Diagram 1

8.10 Main Arm Wiring Diagram 2

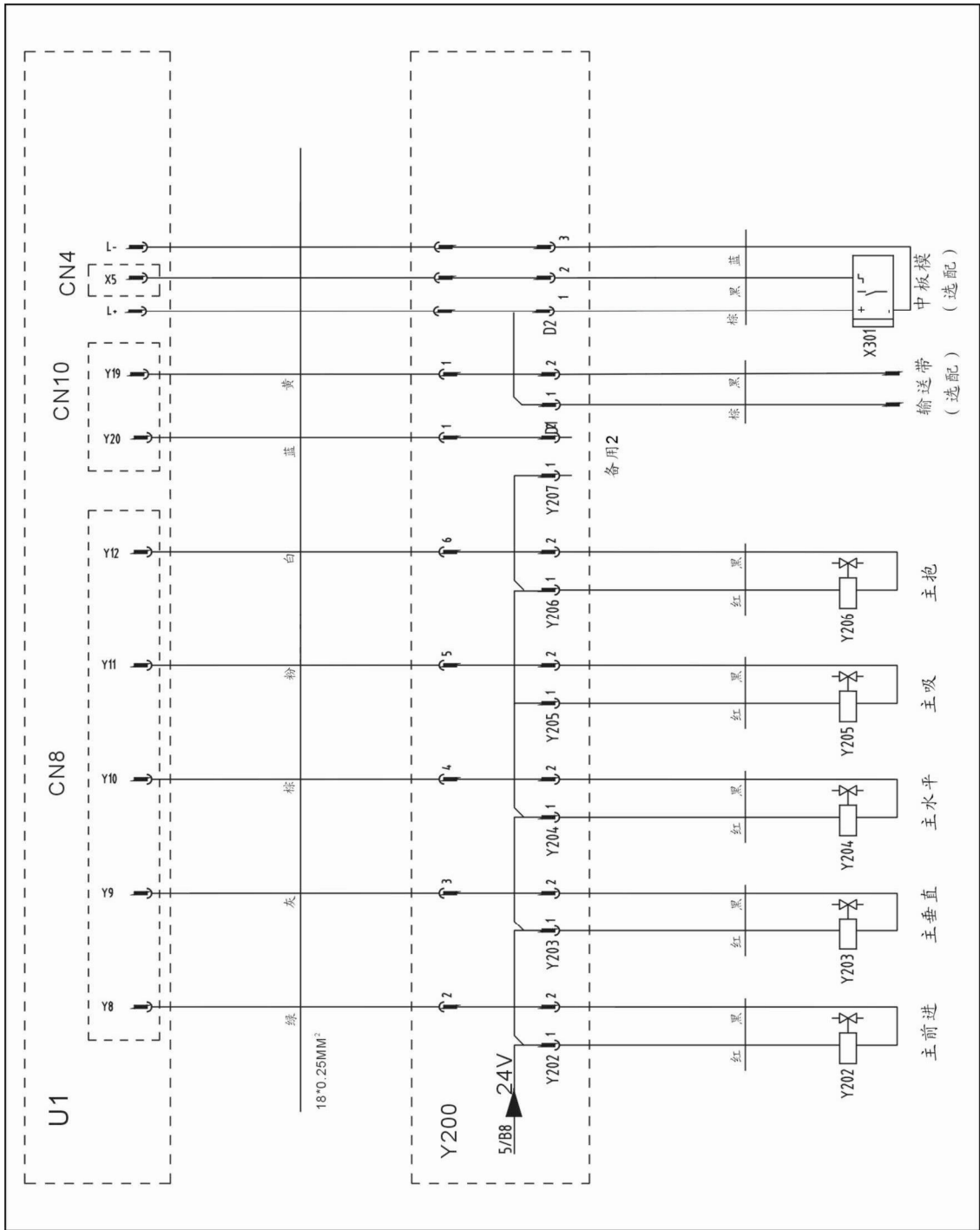

Picture 8-10: Main Arm Wiring Diagram 2

8.11 Sub-arm Wiring Diagram

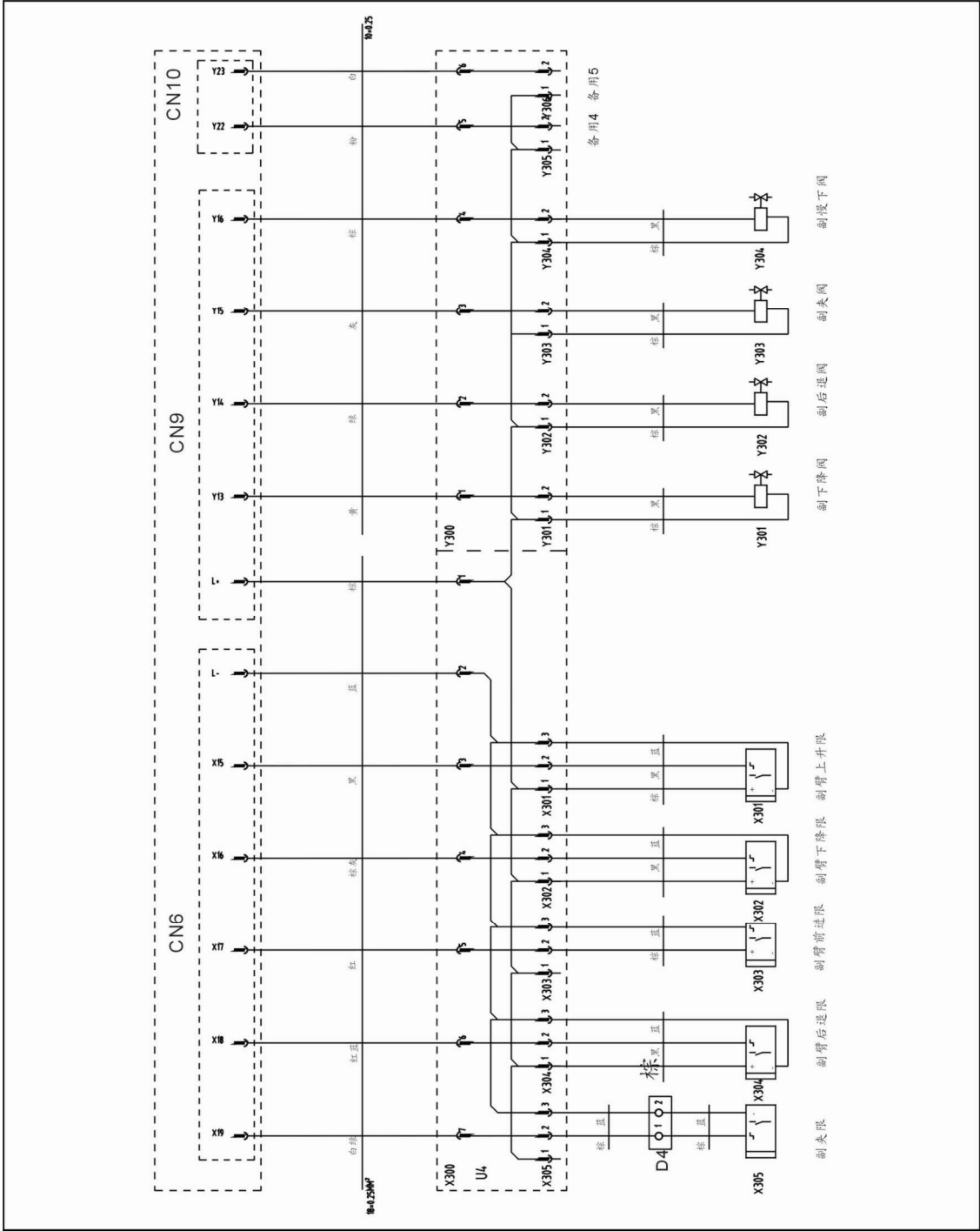

Picture 8-11: Sub-arm Wiring Diagram

8.12 IMM (injection molding machine) Wiring Diagram 1

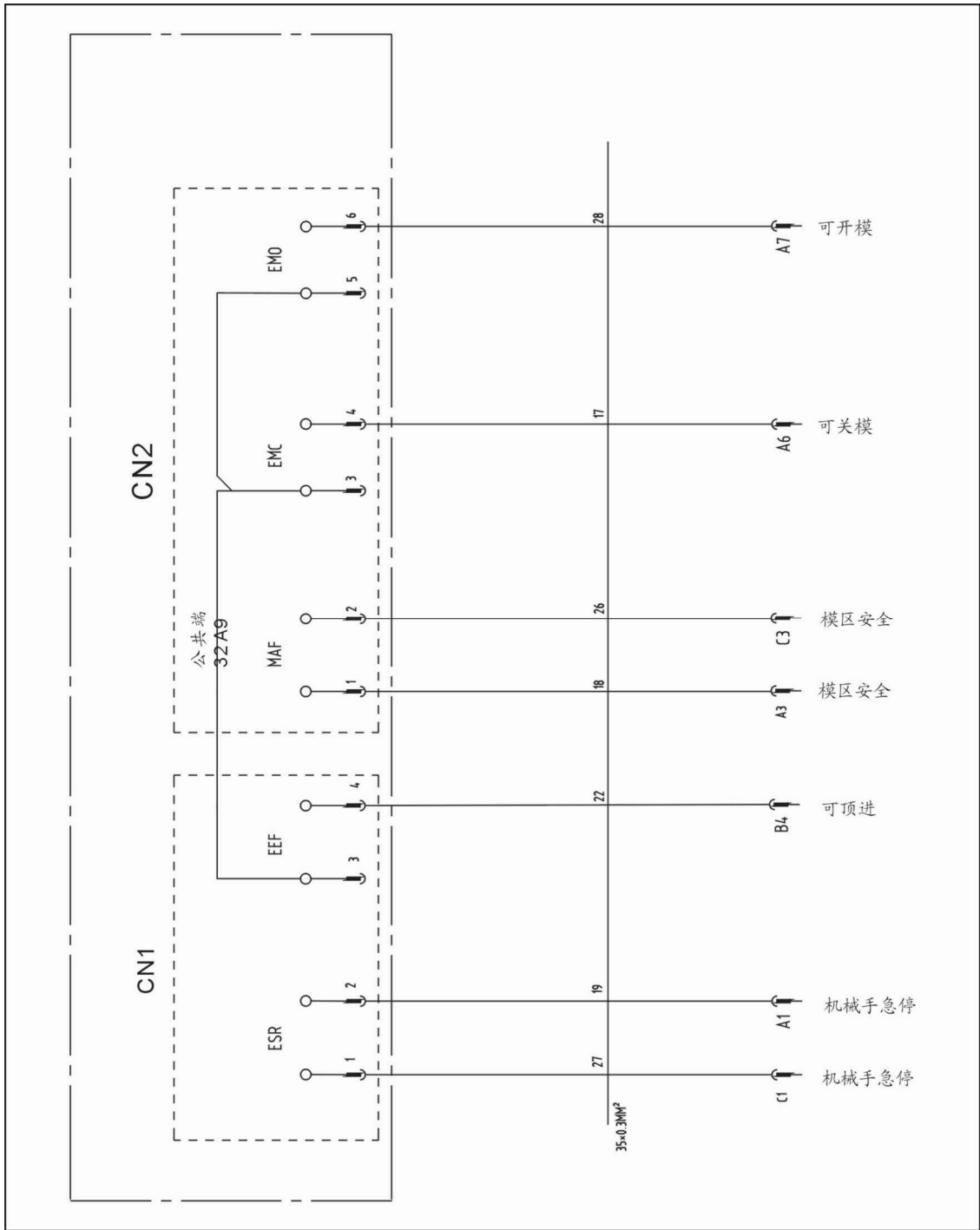

Picture 8-12: IMM (injection molding machine) Wiring Diagram 1

8.13 IMM (injection molding machine) Wiring Diagram 2

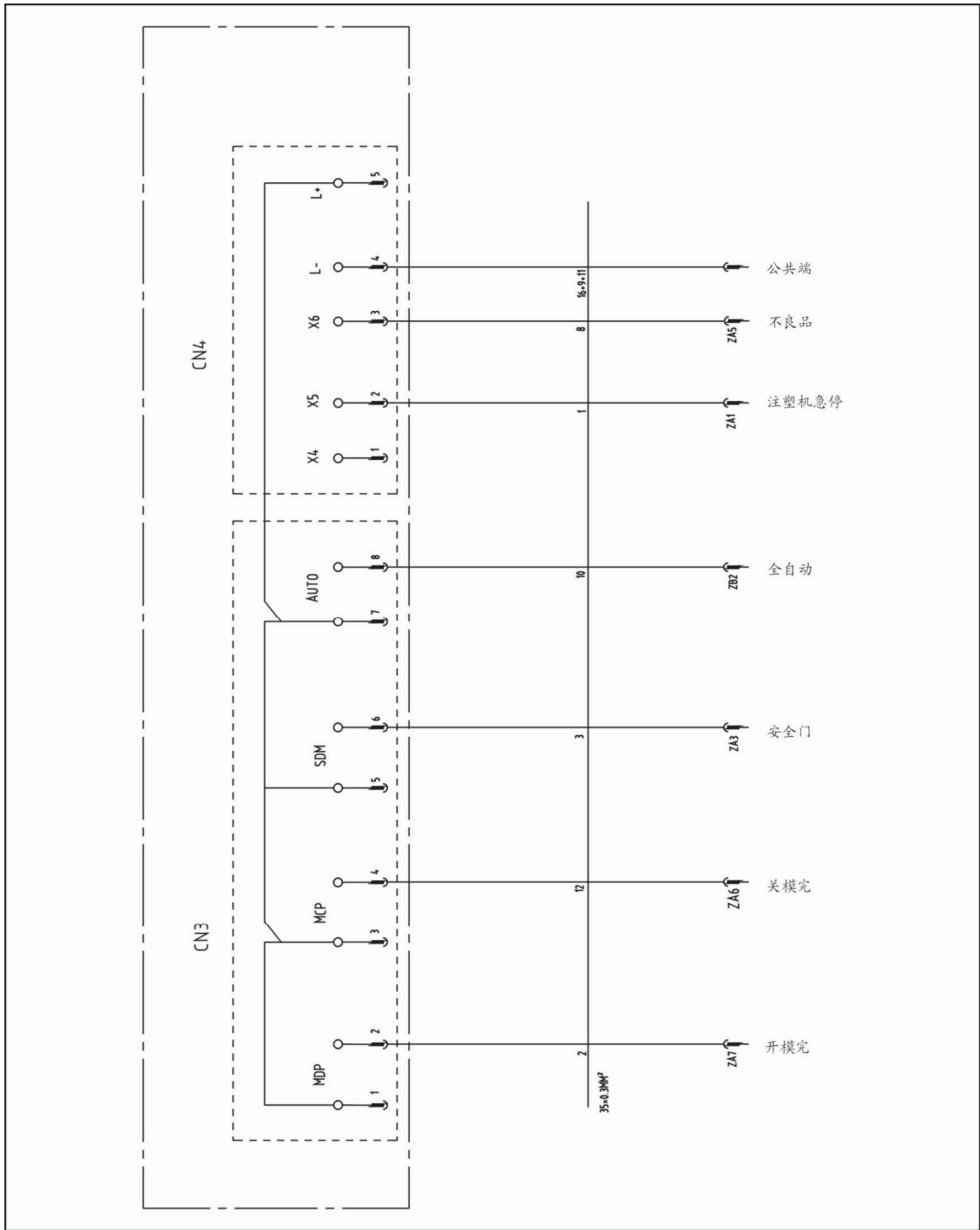

Picture 8-13: IMM (injection molding machine) Wiring Diagram 2

8.15 Pneumatic Schematic Diagram

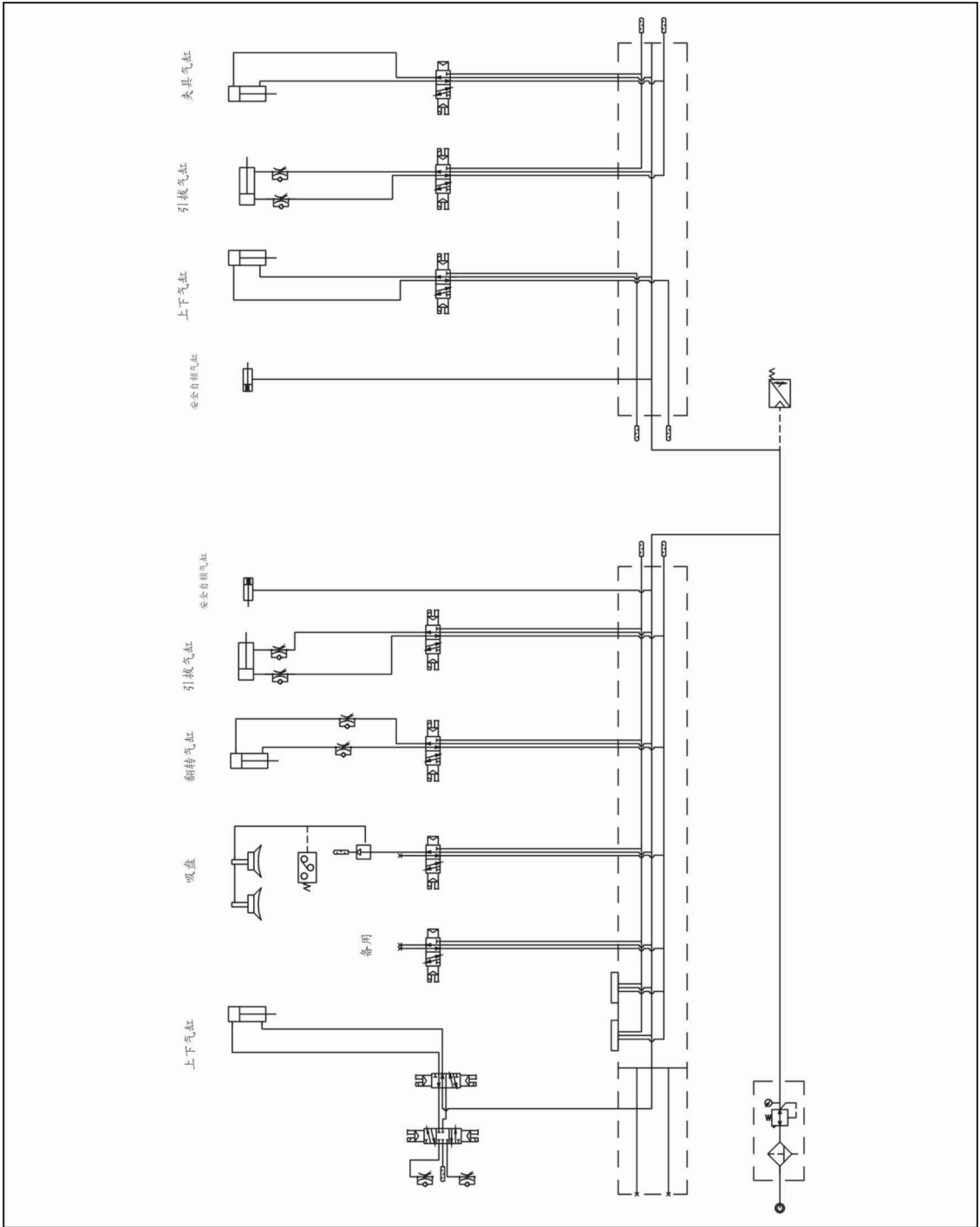

Picture 8-15: Pneumatic Schematic Diagram