

SPV-U

Proportional Valve

Date: Oct., 2021

Version: Ver.D



Content

1. General Description	4
1.1 Coding Principle.....	5
1.2 Feature	5
1.3 Technical Specifications	7
1.3.1 External Dimension	7
1.3.2 Specifications	7
1.4 Safety Regulations.....	8
1.4.1 Safety Signs and Labels.....	8
1.5 Exemption Clause.....	8
2. Structure Characteristics and Working Principle.....	9
2.1 Working Principle.....	9
3. Installation and Debugging	10
3.1 Working with SAL-U.....	10
3.2 Power Supply Connection.....	10
4. Application and Operation.....	11
4.1 SAL-U(-E)、SAL-UG Function Instruction	11
4.1.1 Parameter Settings on SPV-U working with SAL-U(-E) and SAL-UG.....	11
4.1.2 Instruction Diagram about Connecting with "SAL-U (-E)"	11
4.1.3 Instruction Diagram about Connecting with SAL-UG.....	12
4.2 SPV-U with Independent Control Box.....	12
4.2.1 About the Control Panel	12
4.2.2 Start / Stop	13
4.2.3 Settings	13
4.2.4 Connections	16
5. Trouble-shooting.....	16
6. Maintenance and Repair	17
6.1 Maintenance	17
6.2 Maintenance Schedule	18
6.2.1 About the Machine.....	18
6.2.2 Check after Installation	18

Table Index

Table 1-1: Specifications.....	7
Table 4-1: Working with SAL-U(-E)、SAL-UG parameter Settings.....	11

Picture Index

Picture 1-1: Proportional valve	7
Picture 1-2: Control box	7
Picture 2-1: Working principle illustration	9
Picture 3-1: Working with SAL-U.....	10
Picture 4-1: Instruction diagram about connecting with "SAL-U(-E)".....	11
Picture 4-2: Instruction diagram about connecting with SAL-UG	12
Picture 4-3: About the control panel.....	12
Picture 4-4: Material loading diagram of hopper (single-layer working mode) .	14
Picture 4-5: Material loading diagram of hopper (double-layer working mode)	14
Picture 4-6: Material loading diagram of hopper (three-layer working mode)...	15
Picture 4-7: Material loading diagram of hopper (four-layer working mode).....	15
Picture 4-8: Connections.....	16

1. General Description



Read this manual carefully before operation to prevent damage of the machine or personal injuries.

SPV-U series proportional valve mix regrind and new materials in a proper proportion, and then send them back to the molding machine to achieve a proportional mixing and loading effect. It features directly mounted on loaders or mounted on the pipeline. Besides, it is applicable to Euro loaders and has to equip control box to perform when in other situations.



Model: SPV-38U-C

1.1 Coding Principle

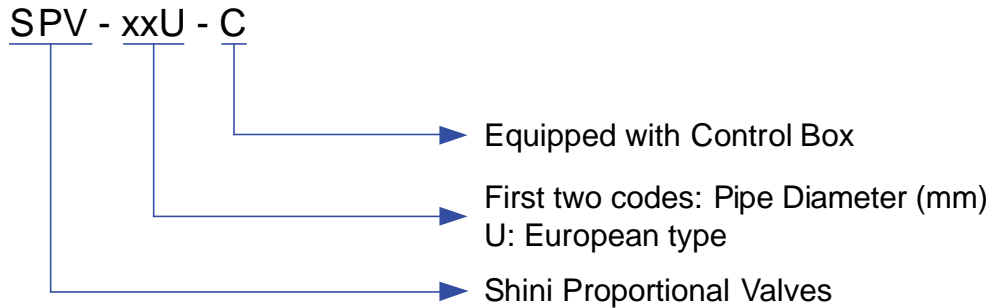

1.2 Feature

1) Standard configuration

- European type design, classy appearance, easy installation and operation.
- Unique design of valve body, make material conveying more smoothly.
- The performance of solenoid valve is so stable that the air cylinder acts accurately to ensure a proportional mixing of new and regrind materials.
- There is no need of ordering control box when working with SAL-U series hopper loaders.
- Instant recycling of regrind materials to reduce production cost.
- Equipped with 1~4 levels working function selection, making material mixing more evenly.

2) Accessory option

- When applied in other conditions, control box can be an option.

All service work should be carried out by a person with technical training or corresponding professional experience. The manual contains instructions for both handling and servicing. Chapter 6, which contains service instructions intended for service engineers. Other chapters contain instructions for the daily operator.

Any modifications of the machine must be approved by SHINI in order to avoid personal injury and damage to machine. We shall not be liable for any damage caused by unauthorized change of the machine.

Our company provides excellent after-sales service. Should you have any problem during using the machine, please contact the company or the local vendor.

Shini Hotline Service:

Headquarter and Taipei factory:

Tel: + 886 (0)2 2680 9119

Shini Plastics Technologies (Dongguan), Inc.:

Tel: +86 (0)769 8331 3588

Shini Plastics Technologies (Pinghu), Inc.:

Tel: +86 (0)573 8522 5288

Shinden Precision Machinery (Chongqing), Inc.:

+86 (0)23 6431 0898

1.3 Technical Specifications

1.3.1 External Dimension

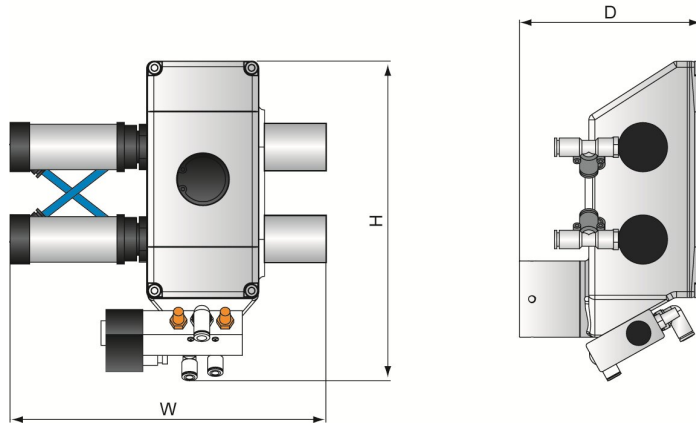

Picture 1-1: Proportional valve

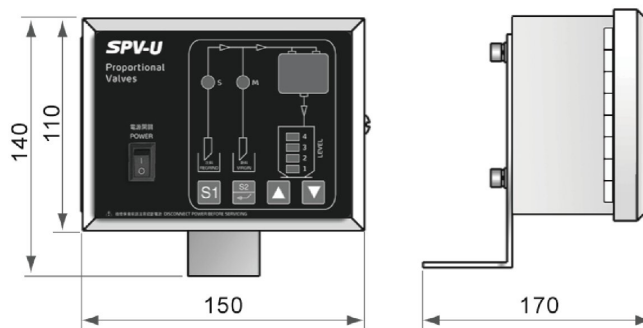

Picture 1-2: Control box

1.3.2 Specifications

Table 1-1: Specifications

Model	Ver.	Compressed Air Pressure	Driven Means	Maximum Material Flow	Pipe Size (inch)	Dimensions (mm) H×W×D	Weight (kg)
SPV-38U-(C)	D	3kgf/cm ² Compressed Air	Cylinders	350kg/hr	1.5	270 × 260 × 150	3.5
SPV-50U-(C)	D	3kgf/cm ² Compressed Air	Cylinders	550kg/hr	2	270 × 260 × 150	3.8

Note:1) "C" stands for control box, there is no need of control box when working with SAL-U loaders.

We reserve the right to change specifications without prior notice.

2) Above maximum passing rate is based on pellet material of 0.65kg/L in bulk density and 3-5mm in diameter.

2) Power supply: 1Φ, 115 / 230VAC, 50/60Hz.

1.4 Safety Regulations

To avoid any body injures and damages of the machine, please do to observe the regulations in this manual.

When operating this machine, please observe the regulations as follows.

1.4.1 Safety Signs and Labels



Warning! Be careful!

This label means that this area should be taken care!



Attention!

No need for regular inspection because all the electrical parts in the control unit are fixed tightly!

1.5 Exemption Clause

The following statements clarify the responsibilities and regulations born by any buyer or user who purchases products and accessories from Shini (including employees and agents).

Shini is exempted from liability for any costs, fees, claims and losses caused by reasons below:

1. Any careless or man-made installations, operation and maintenances upon machines without referring to the manual prior to machine using.
2. Any incidents beyond human reasonable controls, which include man-made vicious or deliberate damages or abnormal power, and machine faults caused by irresistible natural disasters including fire, flood, storm and earthquake.
3. Any operational actions that are not authorized by Shini upon machine, including adding or replacing accessories, dismantling, delivering or repairing.
4. Employing consumables or oil media that are not appointed by Shini.

2. Structure Characteristics and Working Principle

2.1 Working Principle

After setting the suction time and regrinds' proportion, the cylinder drives the closing and opening time of the diaphragm 1 and diaphragm 2 to control the proportion of the virgin materials and regrinds entering the hopper, so as to achieve the purpose of the proportional mixing.

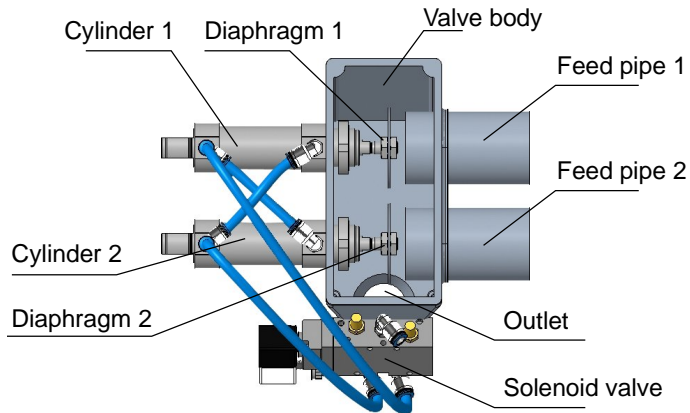

Picture 2-1: Working principle illustration

3. Installation and Debugging

Read the instruction carefully before installation, must observe the installation steps as follows!



When installing SPV, please connect to the compressed air tube according to the requirements.

Notes for Installation and Positioning:

- 1) Machine just can be mounted in vertical position. Make sure there's no pipe, fixed structure or other objects above the installing location and around the machine which may block machine's installation, hit objects or injure human person.
- 2) For easy maintenance, it's suggested to leave 1m space around the machine.
- 3) Machine should be placed on water-level surface. If it needs to be mounted on a higher surface (e.g. the scaffold or the interlayer), should ensure its structure and size could bear the weight and size of the machine.

3.1 Working with SAL-U

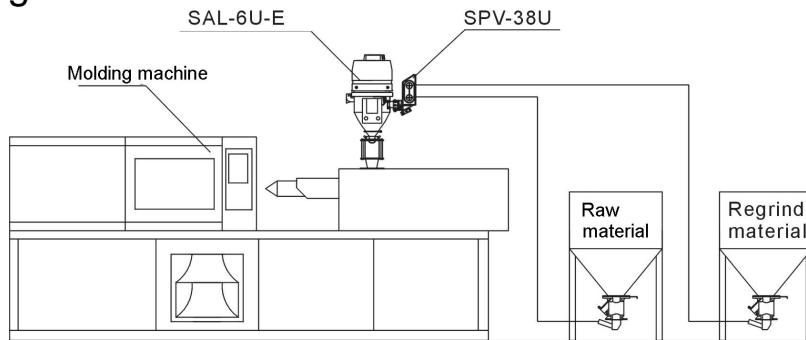

Picture 3-1: Working with SAL-U

Mount the SPV-U at material inlet of the hopper and lock up the fixing screw; connect the material inlet of SPV-U to material storage tank or outlet of machine with the steel wired plastic pipe.

Notice:

As shown in above picture, the feed box is at the bottom during installation to avoid material deposit.

3.2 Power Supply Connection

Connect the 1ΦAC230V power supply and grounding wire to the SPV-U control box.

4. Application and Operation

SAL-U(-E) or SAL-UG has integrated with the SPV-U single-layer control function. When SPV-U collocated with hopper loader SAL-U(-E) or SAL-UG, if users just need single-layer control mode, please according to the SAL-U(-E), SAL-UG operation manual to set the loading time; if users need double, three, four layers control mode, it should use SPV-U original control box to set the parameter.

4.1 SAL-U(-E)、SAL-UG Function Instruction

4.1.1 Parameter Settings on SPV-U working with SAL-U(-E) and SAL-UG

Table 4-1: Working with SAL-U(-E)、SAL-UG parameter Settings

Function Symbol	Function Instruction	Parameter value	
		Setting before Delivery	Range
F. 02	<p>Mixing time</p> <p>Starting at the same time with suction, setting the time before suction time [F.02]sec.</p> <p>Action time calculate style: suction time×[F.02]% setting "0"means stop.</p>	0% No starting	0~100%

4.1.2 Instruction Diagram about Connecting with "SAL-U (-E)"

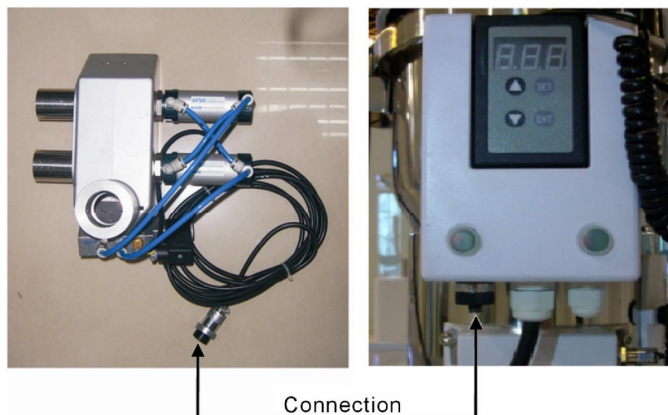

Picture 4-1: Instruction diagram about connecting with "SAL-U(-E)"

4.1.3 Instruction Diagram about Connecting with SAL-UG

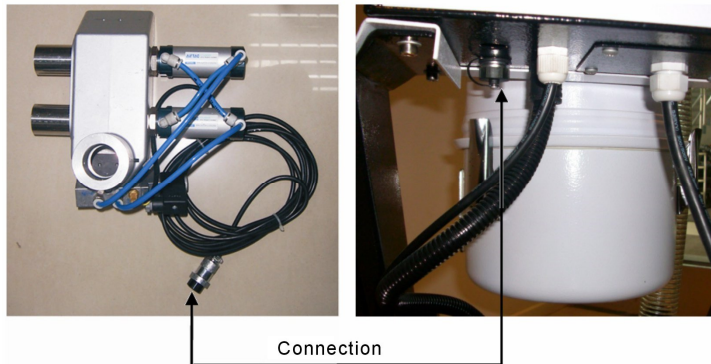

Picture 4-2: Instruction diagram about connecting with SAL-UG

4.2 SPV-U with Independent Control Box

4.2.1 About the Control Panel

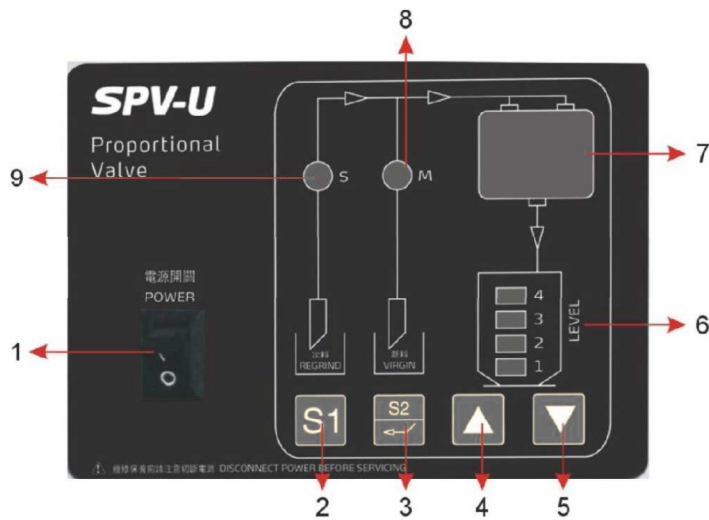

Picture 4-3: About the control panel

No	Name	Function Description
1	Power	Power on to start the machine
2	Loading time set	Press this key to set loading time
3	Regrind percentage set	Press this key to set the percentage
4	Up key	Press this key to increase set value
5	Down key	Press this key to decrease set value
6	Working mode indicator	Indicating working mode
7	Display setup value or working status	Display setup value or working status









8	New material conveying indicator	When new material suction begins, the indicator on.
9	Regrind material conveying indicator	When regrind material suction begins, the indicator on.



4.2.2 Start / Stop

1. Power on to start the machine, it will display software version "XX" (about 1second).
2. Turn off the power to stop the machine.
3. Shut off the loading signal to stop mixing.

4.2.3 Settings

Parameter Setting

1. Displaying value will blink right after press **S1** key, new material indicator  will lighten, **【F01】** loading time (5~99 secs) is available for setting. Press  or  key to adjust loading time, and to press **S1** or **S2** after setup to confirm and save the value, but it will bounce out automatically without save if there is no input for 5 seconds.
2. Displaying value will blink right after press **S2** key, regrind material indicator  will blink, **【F02】** regrind percentage (1~99 %) is adjustable. Press  or  key to adjust loading time, and to press **S2** after setup to confirm and save the value, but it will bounce out automatically without save if there is no input for 5 seconds.
3. Displaying value will lighten right after press  +  for 3 seconds, working

mode indicators  will lighten, **【F03】** (use 1, 2, 3, 4 to stand for different working modes). Press  or  key to adjust working mode, and to press **S1** or **S2** after setup to confirm and save the value, but it will bounce out automatically without save if there is no input for 5 seconds.

Working mode selection

1. Working mode 1: (1-percentage)×loading time is for new material + percentage × loading time is for regrind material.
For example: Total loading time is 10 second.
Regrind percentage is 10%. 9 → 1

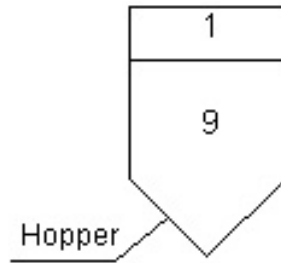

Picture 4-4: Material loading diagram of hopper (single-layer working mode)

2. Working mode 2: $(1 - \text{percentage}) \times \text{half of the loading time}$ is for new material + $\text{percentage} \times \text{half of the loading time}$ is for regrind material + $(1 - \text{percentage}) \times \text{half of the loading time}$ is for new material + $\text{percentage} \times \text{half of the loading time}$ is for regrind material.

For example: Total loading time is 20 second. Regrind percentage is 10%.

$9 \rightarrow 1 \rightarrow 9 \rightarrow 1$

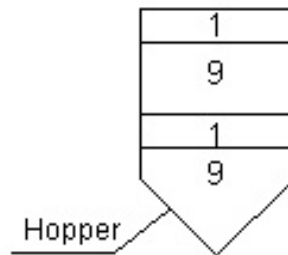

Picture 4-5: Material loading diagram of hopper (double-layer working mode)

3. Working mode 3: $(1 - \text{percentage}) \times \text{one third of the loading time}$ is for new material + $\text{percentage} \times \text{one third loading time}$ is for regrind material + $(1 - \text{percentage}) \times \text{one third of the Loading time}$ is for new material + $\text{percentage} \times \text{one third loading time}$ is for regrind material + $(1 - \text{percentage}) \times \text{one third of the loading time}$ is for new material + $\text{percentage} \times \text{one third loading time}$ is for regrind material.

For example: Total loading time is 30 second. Regrind percentage is 10%.

$9 \rightarrow 1 \rightarrow 9 \rightarrow 1 \rightarrow 9 \rightarrow 1$

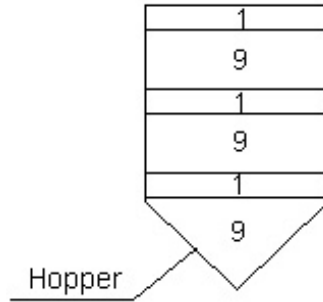

Picture 4-6: Material loading diagram of hopper (three-layer working mode)

4. Working mode 4: (1-percentage) × one fourth of the Loading time is for new material + percentage × one fourth loading time is for regrind material + (1-percentage) × one fourth of the Loading time is for new material + percentage × one fourth loading time is for regrind material + (1-percentage) × one fourth of the Loading time is for new material + percentage × one fourth loading time is for regrind material + (1-percentage) × one fourth of the Loading time is for new material + percentage × one fourth loading time is for regrind material.

For example: Total loading time is 40 second.

Regrind percentage is 20%.

8 → 2 → 8 → 2 → 8 → 2 → 8 → 2

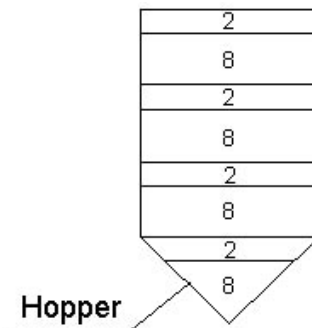

Picture 4-7: Material loading diagram of hopper (four-layer working mode)

Settings

1. Working mode 1: Applicable range 5~99sec
 2. Working mode 2: Applicable range 16~99sec
 3. Working mode 3: Applicable range 31~99sec
 4. Working mode 4: Applicable range 45~99sec
- ※ Minimal regrind loading time is 1sec

※At setting mode, if to adjust【F01~F03】, the software will automatically ensure regrind loading time be no less than 1sec

4.2.4 Connections

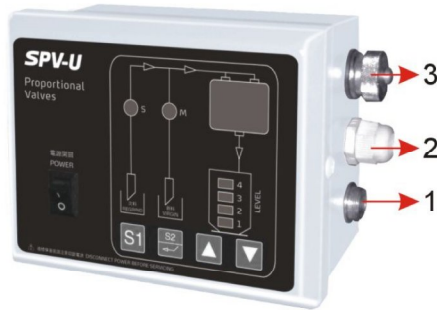

Picture 4-8: Connections

No.	Name	Function Description
1	Input loading signal	SPV-U will be receiving an activation signal when hopper loader starts
2	Power cable	SPV-U will be receiving an activation signal when hopper loader starts
3	Output signal for Proportioning solenoid valve	Proportioning solenoid valve will open when hopper loader is working

5. Trouble-shooting

Failures	Possible Reasons	Solutions
Cylinder does not work	1. Solenoid valve broken	1. Replace
	2. Did not connect the compressed air tube	2. Connect
	3. Did not connect signal wire or broken	3. Connect or changed

6. Maintenance and Repair

6.1 Maintenance

All the repair work should be done by professionals in order to prevent personal injuries and damage of the machine.

Keep the external valve body clean, pay attention to the solenoid valve's maintenance.

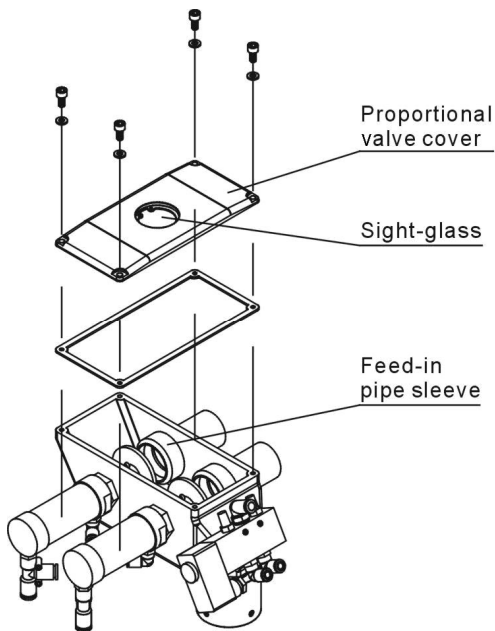

1. Open the proportional valve cap and check whether the material inlet pipe sleeve is seriously worn and teared, replace it when there is air leakage.
2. Check the wear condition of the material inlet pipe sleeve from the sight window.
Period: Daily.

6.2 Maintenance Schedule

6.2.1 About the Machine

Model _____ SN _____ Manufacture date _____

Voltage _____ Φ _____ V Frequency _____ Hz Power _____ kW

6.2.2 Check after Installation

- Make sure the pipe connecting is correct
- Make sure the connecting pipe is lock and tighten
- Make sure the mounting base is lock and tighten

Electrical Installation

- Voltage check: _____ V _____ Hz
- Signal wire connecting
- Pressure air connecting