

Ver.B

Mark	Before modification	Modified by	Modify date	Checked by	Date	Proofread by	Approved by	Version	D	Title	SSC-50	Drawing NO.	SSC-50-CE-4.00V-D-1	Scale	CE	Page	1	
	After modification				20201010					Main Circuit Diagram				Standard		Totally	4	
																	Pages	
																	Voltage	3φ400V
																	Frequency	50HZ

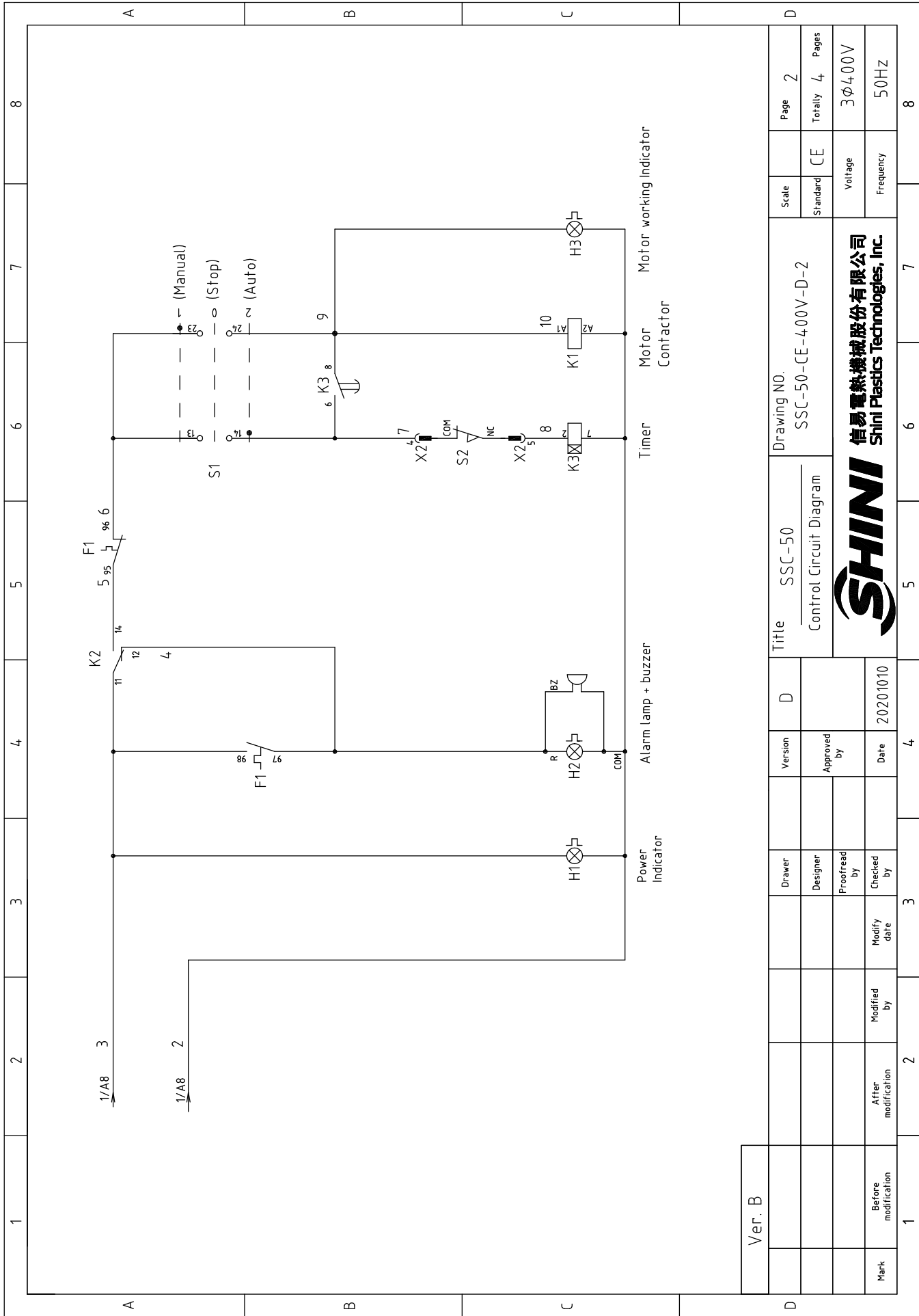



Mark	Before modification	Modified by	Modify date	Checked by	Date	Proofread by	Designer	Drawer	Version	D	Title	SSC-50 Control Circuit Diagram	Drawing NO.	SSC-50-CE-4.00V-D-2	Scale	CE	Page	2	
					20201010				Approved by								Totally	4	
																		Pages	
																			3Φ4.00V
																			50HZ

**SHINI**  
 信易電熱機械股份有限公司  
 Shini Plastics Technologies, Inc.

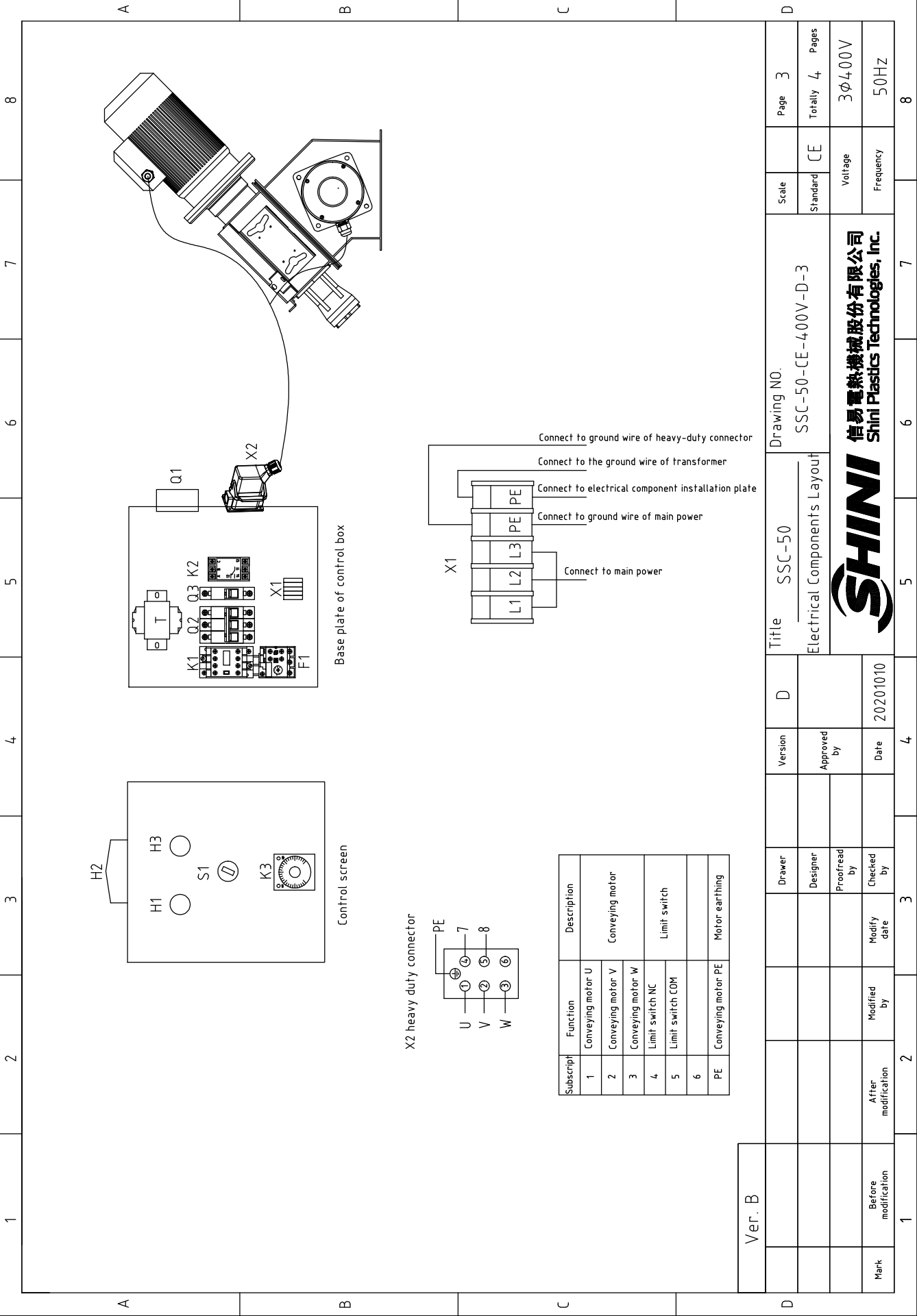

Subscript	Function	Description
1	Conveying motor U	Conveying motor
2	Conveying motor V	
3	Conveying motor W	
4	Limit switch NC	Limit switch
5	Limit switch COM	
6	Conveying motor PE	Motor earthing

Ver. B	1		2		3		4		5		6		7		8	
	Mark	Before modification	After modification	Modified by	Modify date	Checked by	Proofread by	Designer	Drawer	Version	D	Title SSC-50		Drawing NO. SSC-50-CE-400V-D-3		
											Approved by			Scale	Page 3	
														Standard	Totally 4	
															Pages	
															3Φ400V	
															Frequency	
															50HZ	



1		2		3		4		5		6		7		8	
NO.	Symbol	Name	Manufacturer	Type	Specification	Number	Material number	Remark							
1	Q1	Main power switch	EATON	TO-2-1/EA/SVB	20A	1	YE10021160000								
2	Q2	Circuit_Breakers	TECO	BM-63C/3010S	10A	1	YE40301003000								
3	Q3	Circuit_Breakers	TECO	BM-63C/1003S	3A	1	YE40100203000								
4	K1	Contactors	SIEMENS	3RT6017-1AB01	AC24V	1	YE00601702500								
5	K2	Phase sequence protector	CHAOSHI	ABJ2-12W	400VAC 50/60HZ	1	YE03103800000								
6	K3	Timer	YUYUN	TM48S-AB	24-240V	1	YE03482400000								
7	F1	Overload Relay	SIEMENS	3RU6116-1CB0	1.8-2.5A	1	YE01160180000								
8	T	Transformer	JIUXIN	IN=400V/415V OUT=24V	120VA	1	YE70040006600								
9	S1	Selection switch	ABB	C3SS1-10B-20	----	1	YE12102000000								
10	S2	Limit Switch	----	----	----	1	----	(1)							
11	H1	Green indicating lamp	ABB	CL2-502G	24VAC	1	YE83050200100								
12	H2	Three-color alarm lamp	HONGYUN	----	24VAC	1	BL90000011520								
13	H3	White indicating lamp	ABB	CL-502C	24VAC	1	YE83050200300								
14	X1	Card terminal board	HONEYWELL	2.5mm <sup>2</sup>	----	4	YE61250040000								
15		Grounding terminal board	HONEYWELL	2.5mm <sup>2</sup> PE	----	2	YE61253500000								
16		Terminal fittings E/GK series(honeywell)	HONEYWELL	GK	E	3	YE60000003900								
17	X2	Heavy-duty connector	HARTING	Han E-6F Female	6P	1	YE68000601300								
18		Heavy-duty connector	HARTING	Han E-6M Male	6P	1	YE68000601700	(1)							
19		Cable clamp	----	----	PG16	1	YE67001600000	(1)							
20	M1	Motor	WEG	0.75KW	400V 50HZ	1	----	(1)							
21															
22															
23															
24															
25															
Ver. B															
Note: (1) Means not part of control box.															
				Title		SSC-50		Drawing NO.		SSC-50-CE-400V-D-4		Scale		Page 4	
				Version		D		Electrical Components List		Standard		CE		Totally 4 Pages	
				Designer		Approved by				Voltage		3φ400V			
				Proofread by		Date		20201010		Frequency		50HZ			
Mark		Before modification		Modified by		Modify date									
1		2		3		4		5		6		7		8	



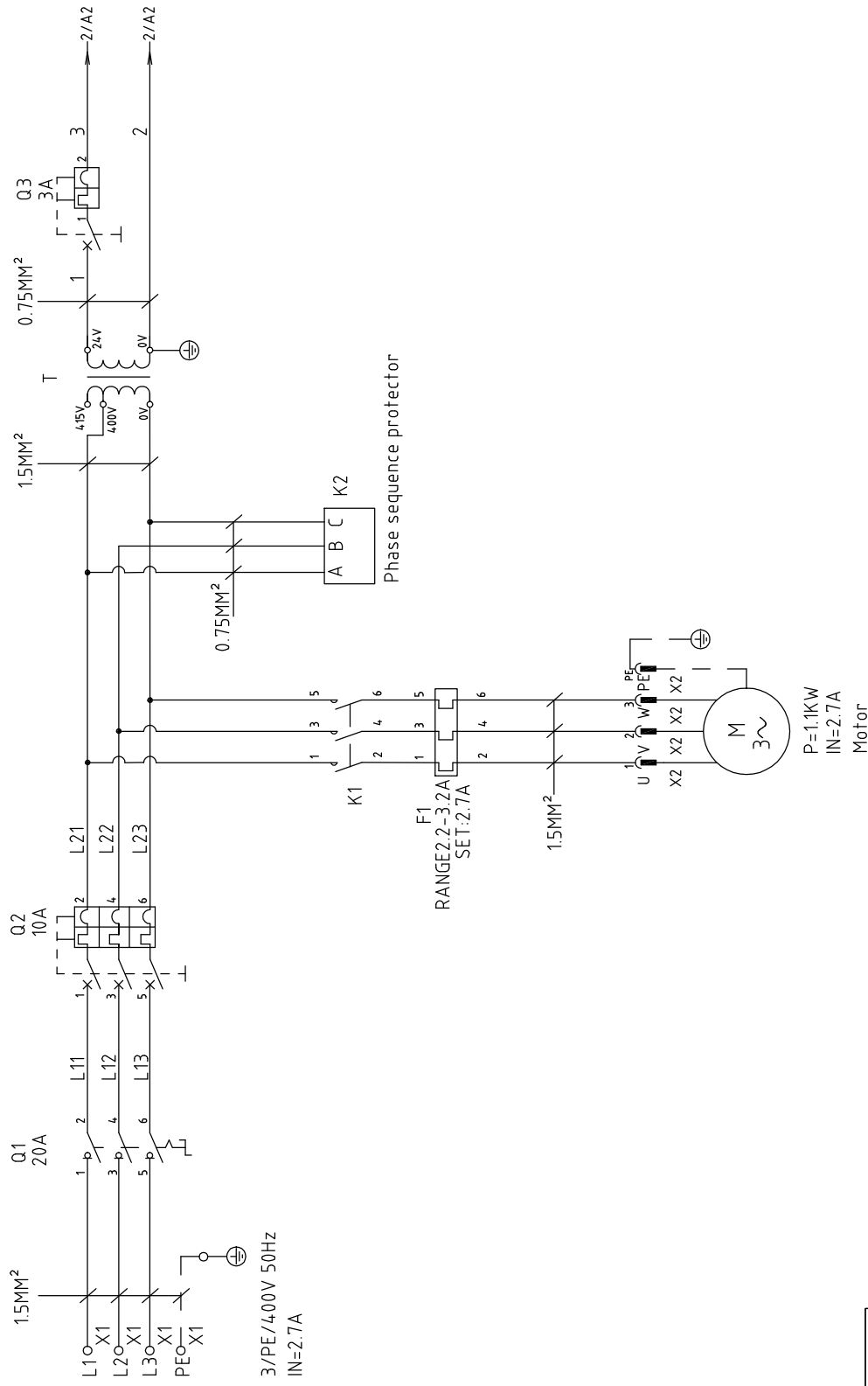

1	2		3		4		5		6		7		8	
Ver.C													Page 1	
D													Scale	
Title													Standard	
Drawing NO.													Voltage	
Main Circuit Diagram													Frequency	
SSC-65													Totally 4	
SSC-65-CE-4.00V-D-1													Pages	
SHINI													3φ400V	
信易電熱機械股份有限公司													50HZ	
Shini Plastics Technologies, Inc.													8	
Version													Date	
Approved by													20201010	
Checked by													4	
Modified by													3	
Modified date													2	
After modification													1	
Mark													1	
Before modification													2	
Date													3	
Checked by													4	
Proofread by													5	
Designer													6	
Drawer													7	
D													8	

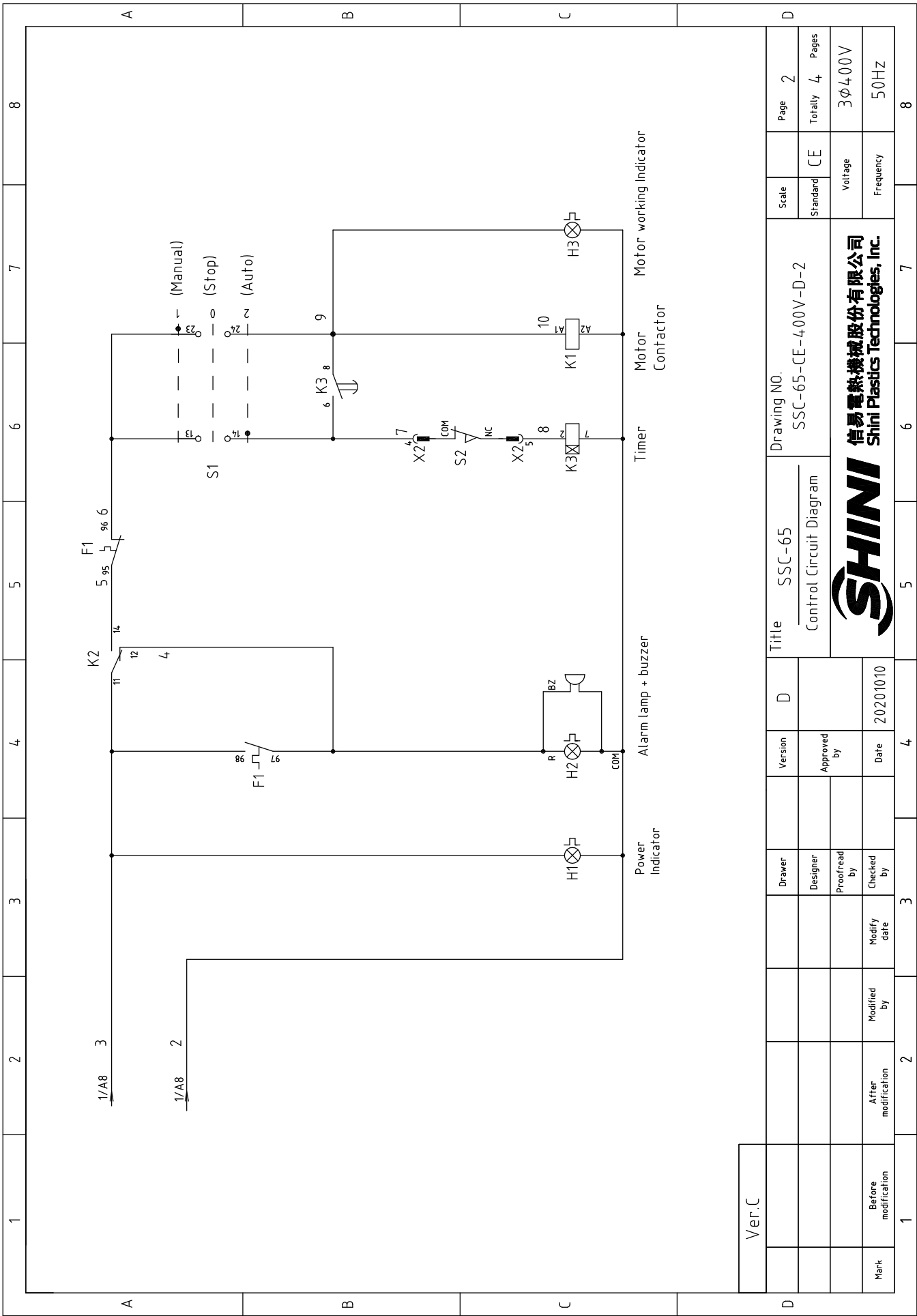

Ver.C													
Mark	Before modification	Modified by	Modify date	Checked by	Proofread by	Designer	Drawer	Version	D	Title	SSC-65	Drawing NO.	SSC-65-CE-4.00V-D-2
	After modification							Approved by		Control Circuit Diagram			Standard
								Date	20201010				CE
													Voltage
													Frequency
													3Φ4.00V
													50HZ
													Totally
													4
													Page
													2
													8

**SHINI**  
信易電熱機械股份有限公司  
Shini Plastics Technologies, Inc.

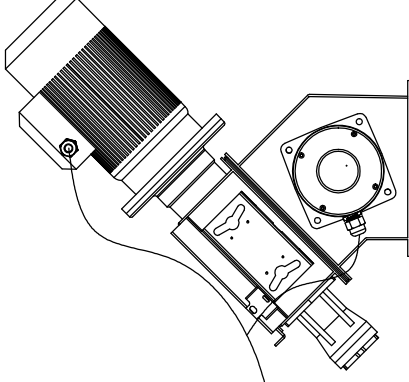
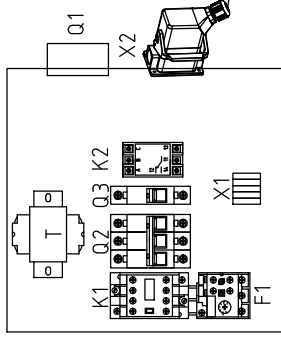
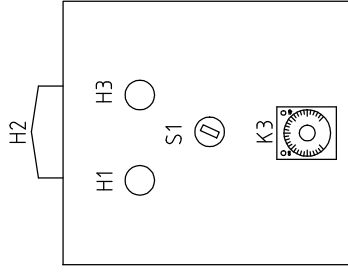

X2 heavy duty connector

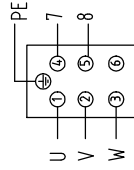

Subscript	Function	Description
1	Conveying motor-U	Conveying motor
2	Conveying motor-V	
3	Conveying motor-W	
4	Limit switch NC	Limit switch
5	Limit switch COM	
6		
PE	Conveying motor-PE	Motor earthing

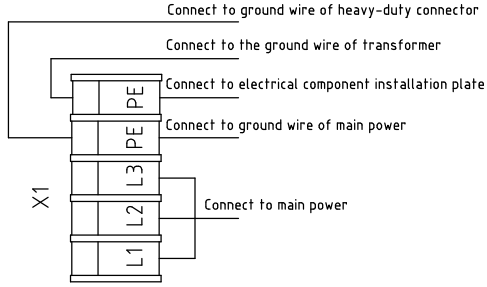

Ver.C

Mark	Before modification	Modified by	Modified date	Checked by	Proofread by	Designer	Drawer	Version	D	Title	SSC-65	Drawing NO.	SSC-65-CE-400V-D-3		Scale	Standard	CE	Totally	4	Pages	
	After modification							Approved by		Electrical Components Layout											
										20201010											
										4											

**SHINI**  
 信易電熱機械股份有限公司  
 Shini Plastics Technologies, Inc.

3φ400V  
50HZ

1		2		3		4		5		6		7		8	
NO.	Symbol	Name	Manufacturer	Type	Specification	Number	Material number	Remark							
1	Q1	Main power switch	EATON	TO-2-1/EA/SVB	20A	1	YE10021160000								
2	Q2	Circuit_Breakers	TECO	BM-63C/3010S	10A	1	YE40301003000								
3	Q3	Circuit_Breakers	TECO	BM-63C/1003S	3A	1	YE40100203000								
4	K1	Contactors	SIEMENS	3RT6017-1AB01	AC24V	1	YE00601702500								
5	K2	Phase sequence protector	CHAOSHI	ABJ2-12W	400VAC 50/60HZ	1	YE03103800000								
6	K3	Timer	YUYUN	TM48S-AB	24-240V	1	YE03482400000								
7	F1	Overload Relay	SIEMENS	3RU6116-1DB0	2.2-3.2A	1	YE01160220000								
8	T	Transformer	JIUXIN	IN=400V/415V OUT=24V	120VA	1	YE70040006600								
9	S1	Selection switch	ABB	C3SS1-10B-20	----	1	YE12102000000								
10	S2	Limit Switch	----	----	----	1	----	(1)							
11	H1	Green indicating lamp	ABB	CL2-502G	24VAC	1	YE83050200100								
12	H2	Three-color alarm lamp	HONGYUN	----	24VAC	1	BL90000011520								
13	H3	White indicating lamp	ABB	CL-502C	24VAC	1	YE83050200300								
14	X1	Card terminal board	HONEYWELL	2.5mm <sup>2</sup>	----	4	YE61250040000								
15		Grounding terminal board	HONEYWELL	2.5mm <sup>2</sup> PE	----	2	YE61253500000								
16		Terminal fittings E/GK series(honeywell)	HONEYWELL	GK	E	3	YE60000003900								
17	X2	Heavy-duty connector	HARTING	Han E-6F Female	6P	1	YE68000601300								
18		Heavy-duty connector	HARTING	Han E-6M Male	6P	1	YE68000601700	(1)							
19		Cable clamp	----	----	PG16	1	YE67001600000	(1)							
20	M1	Motor	----	1.1KW	400V 50HZ	1	----	(1)							
21															
22															
23															
24															
25															
Ver.C		Note: (1) Means not part of control box.													
D		Title		SSC-65		Drawing NO.		SSC-65-CE-400V-D-4		Scale		Page		4	
		Electrical Components List								Standard		CE		Totally 4 Pages	
												Voltage		3φ400V	
Mark		Before modification		Modified by		Modify date		Checked by		Date		Frequency		50HZ	
1		2		3		4		5		6		7		8	

