

整机版本 Ver.C

D	制图	版号	标题	图号	比例	第 1 张
	设计	核 准	SDL-40U- 主电路图	SDL-40U- CE-230V-F-1		
D	校对	日期	日期	日期	机器电压	230V
	审核	日期	日期	日期	机器频率	50Hz
1	更改前	更改后	更改人	更改日期		
2						
3						
4						
5						
6						
7						
8						



信易电热机械股份有限公司
Shini Plastics Technologies, Inc.

无热再生装置 (选配)

吹料风机
P=1.5kW
IN=5.8A

干燥风机
P=0.12kW
IN=0.48A

干燥电热
P=3.0kW
IN=7.9A

邦普K. SF878500A.04 (两机一体SDL-U控制器)

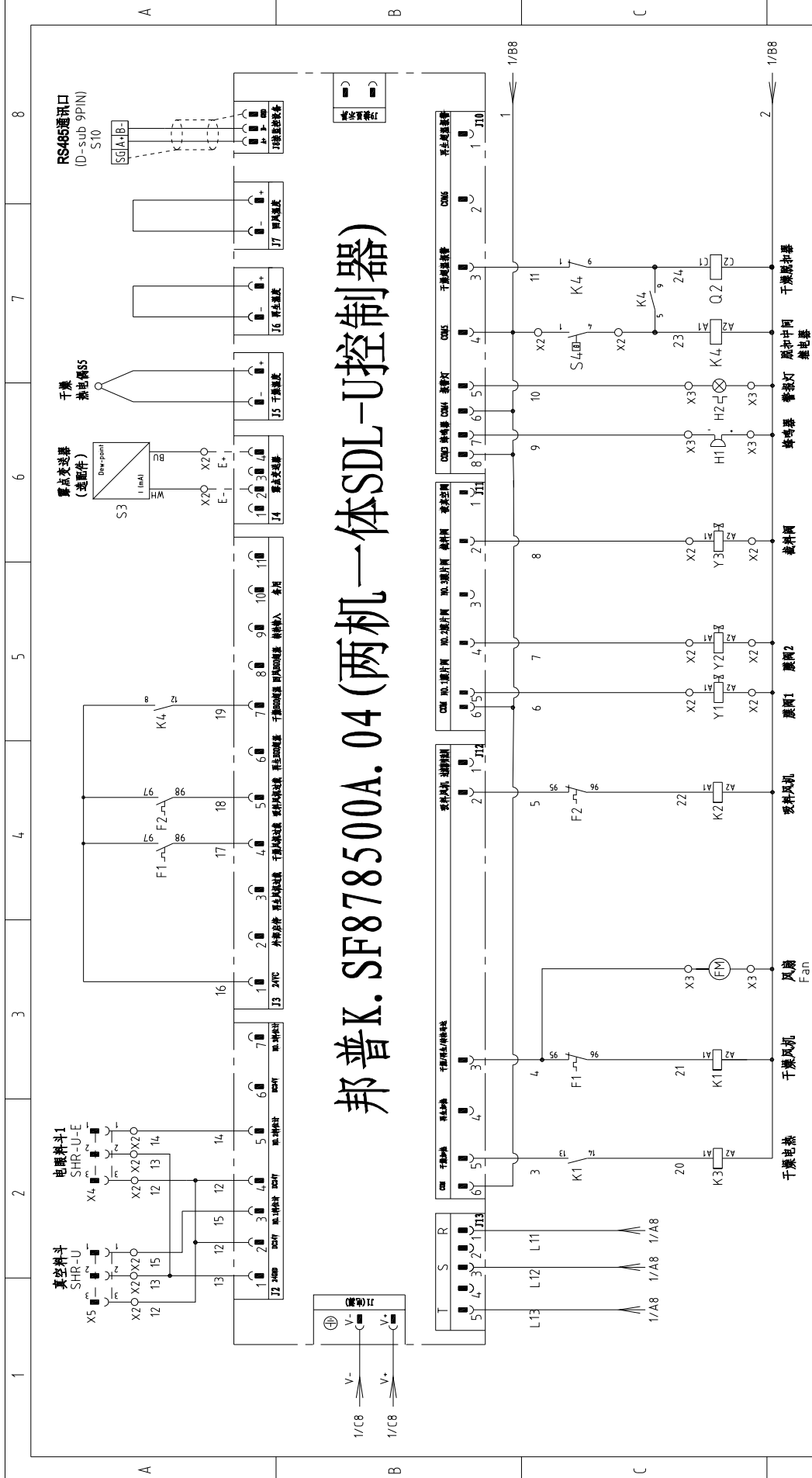

整机版本 Ver.C

D	制图		标题	SDL-40U	图号	SDL-40U- CE-230V-F-2	比例	第 2 张			
	设计		版本号	F	控制电路图		标准	共 5 张			
	校对		核 准				机器电压	230V			
	审核		日期	20170830			机器频率	50Hz			
1	更改前	更改后	更改人	日期	2	3	4	5	6	7	8



1 2 3 4 5 6 7 8

A B C D

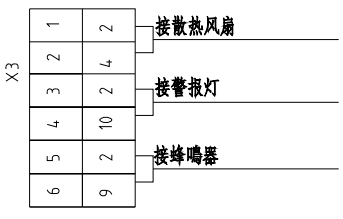
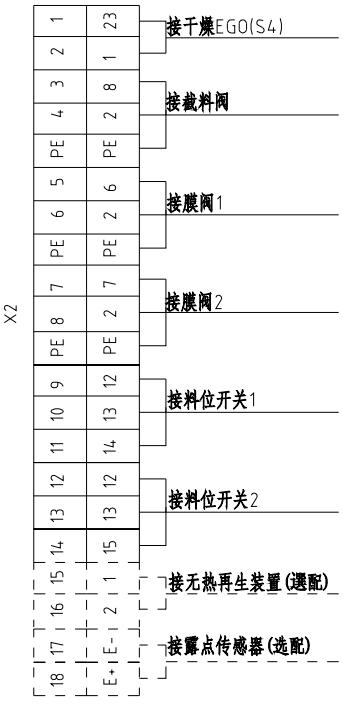
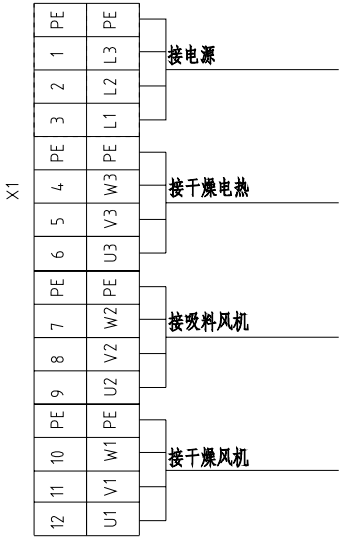
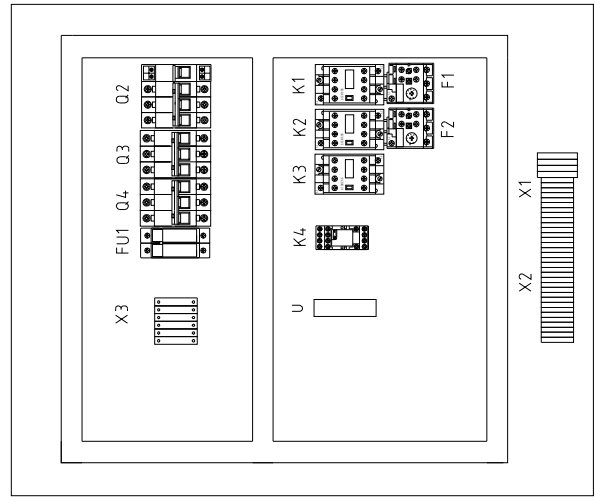
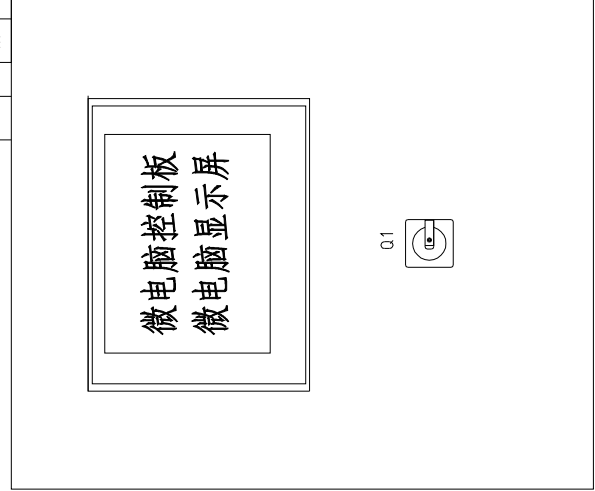

整机版本 Ver.C

图号	SDL-4.0U-CE-230V-F-3	比例	第 3 张
标题	电气元件布置图	标准	共 5 张
版号	F	机器电压	230V
制图	设计	机器频率	50Hz
设计	校对		
日期	20170830		
更改后	更改人		
更改前	日期		



1 2 3 4 5 6 7 8

1		2		3		4		5		6		7		8	
序号/NO	符号/Symbol	名称/Name	制造商/Manufacturer	型号/Type	规格/Specification	数量/Number	物料编号/Material number	备注/Remark							
1	Q1	主电源开关/Main switch	EATON	P1-25/EA/SVB	25A	1	YE10125250000								
2	Q2	断路器/Circuit-breaker	TECO	BM-63C/3010S	10A	1	YE403010030000								
3		励磁释放器/Excitation release	TECO	MX	230V 50/60Hz	1	YE400235600000								
4	Q3	断路器/Circuit-breaker	TECO	BM-63C/3006S	6A	1	YE403006030000								
5	Q4	断路器/Circuit-breaker	TECO	BM-63C/3016S	16A	1	YE403016030000								
6	K1	交流接触器/Contactor	SIEMENS	3RT6015-1AN21	7A 220V 50/60Hz	1	YE006015210000								
7	K2	交流接触器/Contactor	SIEMENS	3RT6016-1AN21	9A 220V 50/60Hz	1	YE006016210000								
8	K3	交流接触器/Contactor	SIEMENS	3RT6017-1AN21	12A 220V 50/60Hz	1	YE006017210000								
9	K4	中间继电器/Middle relay	WEIDMULLER	DRM270730LT	230V 50/60Hz	1	YE032707000000								
10	U	直流电源/DC power	MEAN WELL	NES-35-24	OUT=DC24V 15A	1	YE713524001000								
11	F1	热过载继电器/Overload relay	SIEMENS	3RU6116-0GB0	0.45-0.63A	1	YE011614500000								
12	F2	热过载继电器/Overload relay	SIEMENS	3RU6116-1HB0	5.5-8A	1	YE011605500000								
13	FU1	熔断器座 /Fuse base	CHNT	RT28-32	2P	1	YE410322000000								
14		熔断器芯 /Fuse core	CHNT	10x38 500V	2A	2	YE460020000000								
15	S3	露点变送器/Dew-point Transducer	CS	CS 217-0EM	POWER=24VDC OUT=4-20mA	1	-----	(1)(2)							
16	S4	温度保护器/Temperature protector	EGO	--	115-320°	1	-----	(1)							
17	S5	热电阻/Thermocouple	SHINI	ST-K	K	1	-----	(1)							
18	PCB	两机一体DDI-控制器	PUMP	K SF878500A.04	-----	1	YE808785003000								
19	H1	蜂鸣器/Buzzer	HITPOINT	PK-35A	220V AC/DC	1	YE840035002000								
20	H2	警报指示灯/Alarm indicator	SHINI	LED-3051	230VAC 50Hz	1	YE833051002000	(1)							
21	FM	风扇/Fan	SUNON	DP-200A	230VAC 40W	1	-----	(1)							
22	Y1,Y2,Y3	电磁阀/Solenoid valve	FESTO	MSFW-230-50/60	230VAC 50/60Hz	3	-----	(1)							
23	M1	风机/Blower	SHINI	----	230V 50/60Hz 0.12KW	1	-----	(1)							
24	M2	风机/Blower	SHINI	----	230V 50/60Hz 15KW	1	-----	(1)							
25	EH1	电热器/Heater	SHINI	----	230V 50/60Hz 3.0KW	1	-----	(1)							
整加版本 Ver.C 注: (1)表示非电控箱内材料; (2)表示选配露点计															
			制图	版号	标题	图号		比例		第 4 张					
			设计	核 准	SDL-4.0U	SDL-4.0U-CE-230V-F-4		标准 CE		共 5 张					
			校对	日期	电气元件明细表一		机器电压		230V						
			审核	日期	SHINI		机器频率		50Hz						
标记	更改前	更改后	更改人	日期	SHINI		20170830								
1	2	3	4	5	6	7	8								

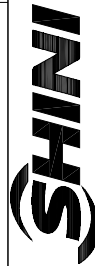

信易电热机械股份有限公司
Shini Plastics Technologies, Inc.

1		2		3		4		5		6		7		8	
序号/NO	符号/Symbol	名称/Name	制造商/Manufacturer	型号/Type	规格/Specification	数量/Number	物料编号/Material number	备注/Remark							
26	X1	端子排/Terminal board	----	4mm ²	----	9	YE60000403200								
27			----	4mm ² PE	----	3	YE60000403500								
28			----	2.5mm ²	----	3	YE60002503200								
29			----	2.5mm ² PE	----	1	YE60002503400								
30	X2	端子排/Terminal board	----	2.5mm ²	----	14	YE60002503200								
31			----	2.5mm ² PE	----	3	YE60002503400								
32			----	2.5mm ²	----	2	YE60002503200	(2)							
33			----	2.5mm ²	----	2	YE60002503200	(3)							
34	X3	端子/Terminal	----	2.5mm ²	----	6	YE60002503200								
35	X4,X5	重载插头/Heavy duty connector	SIBAS	HDC-HA-004.1	4P 10A	2	YE68041000100	(1)							
36	S10	通信接口板IS-485 (德Dsub-9pin接口)	--	--	--	1	YE90048501200	(1)							
37		外殼IS485 (SAL-7000-A-19) 0版	--	--	--	1	YR4.004.8500000	(1)							
38		终端面定伴B/GX系列 (霍尼韦尔)	--	--	--	5	YE600000003900								
<p>整机版本 Ver.C 注: (1)表示非电控箱内材料; (2)表示选配露点计; (3)表示选配无热再生装置。</p>															
D		标题		图号		比例		第 5 张							
		F		SDL-40U 电气元件明细表二		SDL-40U- CE-230V-F-5		标准		CE		共 5 张			
标记		更改前		更改后		更改人		日期		日期		机器电压		230V	
		20170830										机器频率		50Hz	
1		2		3		4		5		6		7		8	



信易电热机械股份有限公司
Shini Plastics Technologies, Inc.

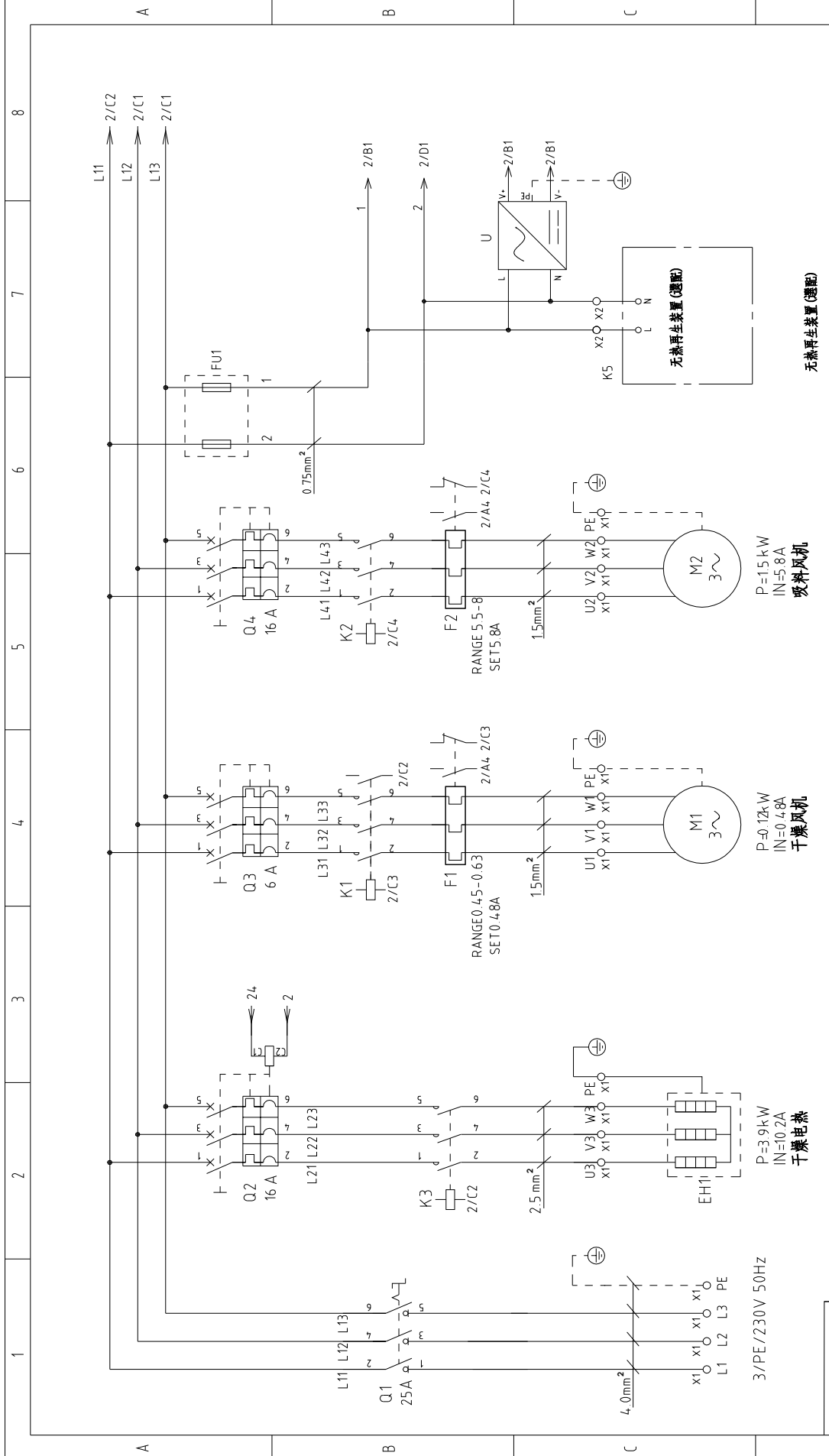

整机版本 Ver.C

1	2	3	4	5	6	7	8
A	B	C	D				
制图	设计	校对	审核	日期	更改人	更改后	更改前
版号	核准	日期	20170830	2	3	4	5
标题	SDL-80U/120U	图号	SDL-80U/120U-CE-230V-F-1	第 1 张	共 5 张	比例	CE
主电路图				机器电压	230V	机器频率	50Hz
信易电热机械股份有限公司 Shini Plastics Technologies, Inc.				无热再生装置 (选配)			
无热再生装置 (选配)				无热再生装置 (选配)			
P=0.12kW IN=0.48A 干燥风机				P=15kW IN=5.8A 吸料风机			

邦普K. SF878500A. 04 (两机一体SDL-U控制器)

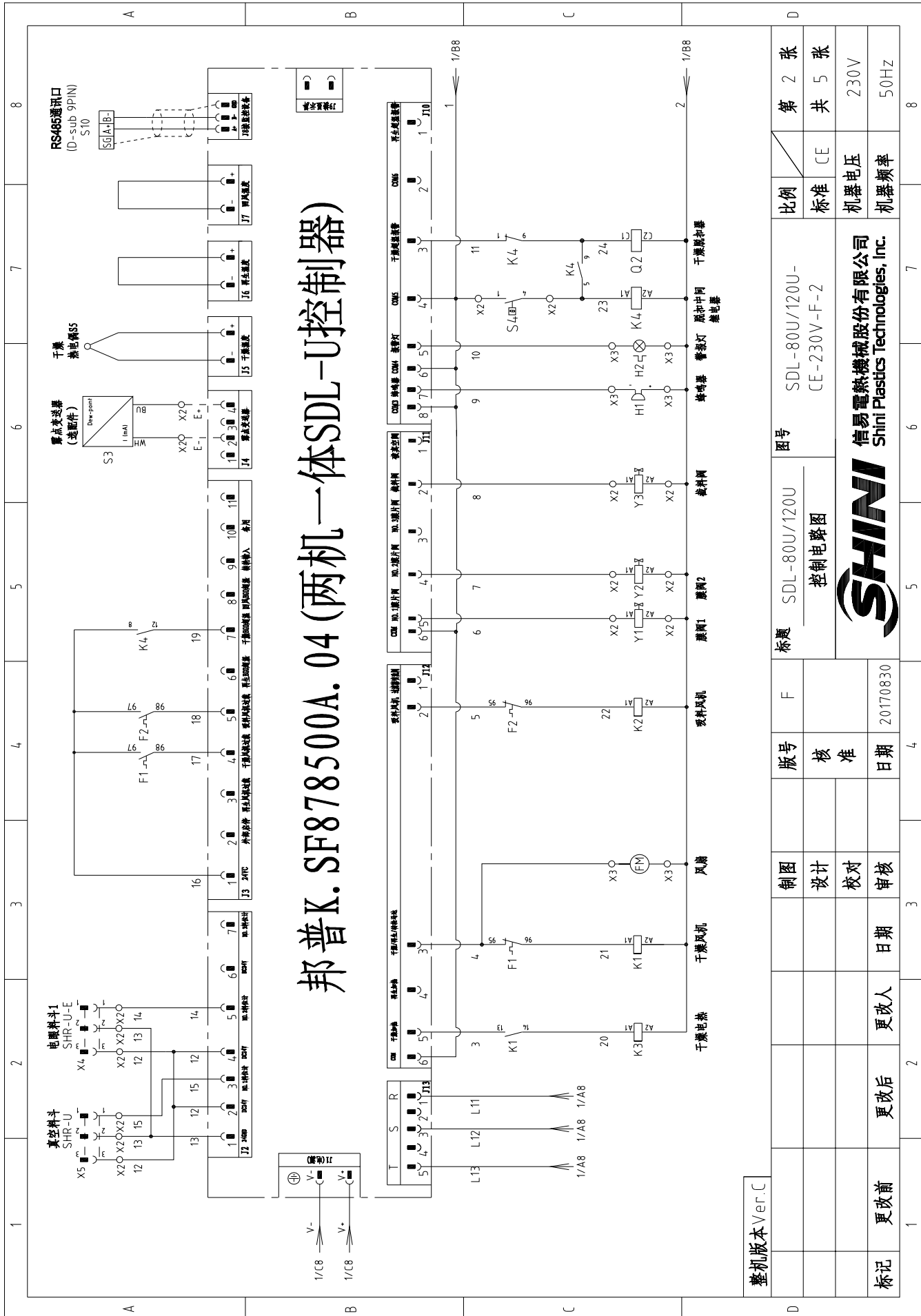

整机版本 Ver.C

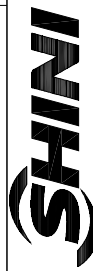
1	2	3	4	5	6	7	8
制图	设计	校对	审核	日期	更改人	日期	更改后
版号	F	核	准	日期	20170830	更改后	更改前
标题	SDL-80U/120U	控制电路图		图号	SDL-80U/120U-CE-230V-F-2	比例	第 2 张
标准	CE	共 5 张		机器电压	230V	机器频率	50Hz
				信易电热机械股份有限公司 Shini Plastics Technologies, Inc.			

1 2 3 4 5 6 7 8

A

B

C

D

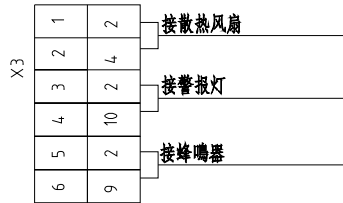
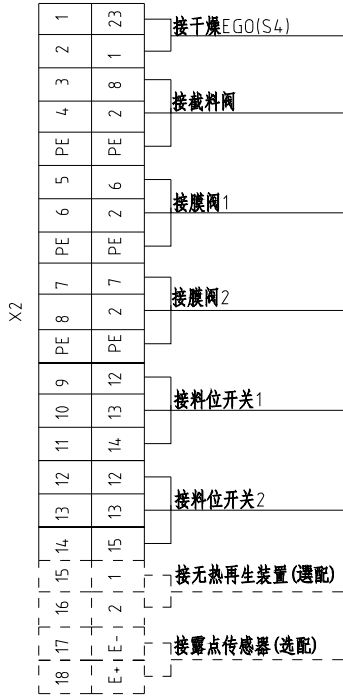
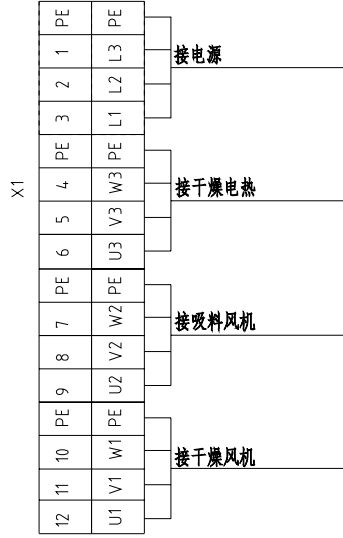
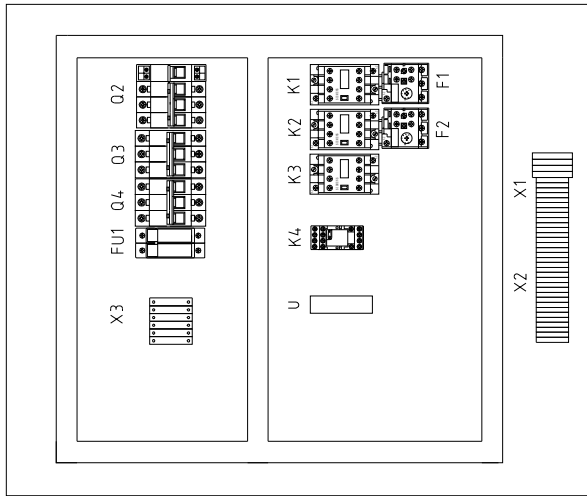
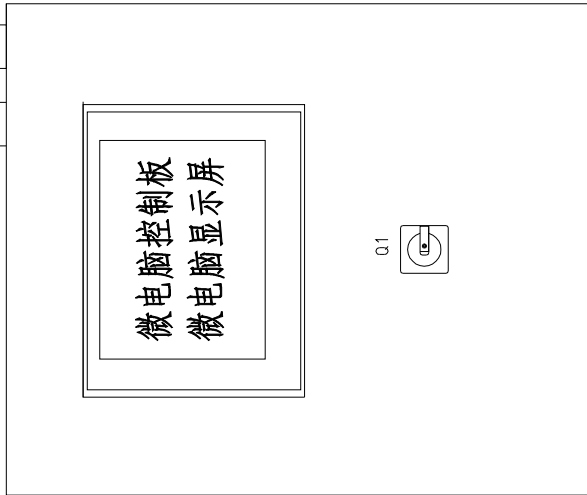

整机版本 Ver.C

比例	第 3 张
标准	共 5 张
机器电压	230V
机器频率	50Hz

图号	SDL-80U/120U-CE-230V-F-3
标题	SDL-80U/120U-电气元件布置图

版号	F	制图	
核 准		设计	
日 期	20170830	校对	
日 期		审核	
更改后	更改人	日期	
更改前			

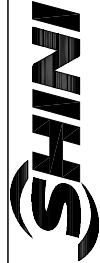

信易电热机械股份有限公司
Shini Plastics Technologies, Inc.

1 2 3 4 5 6 7 8

1		2		3		4		5		6		7		8	
序号/NO	符号/Symbol	名称/Name	制造商/Manufacturer	型号/Type	规格/Specification	数量/Number	物料编号/Material number	备注/Remark							
1	Q1	主电源开关/Main switch	EATON	P1-25/EA/SVB	25A	1	YE10125250000								
2	Q2	断路器/Circuit-breaker	TECO	BM-63C/3016S	16A	1	YE40301603000								
3		励磁释放器/Excitation release	TECO	MX	230V 50/60Hz	1	YE40023560000		A						
4	Q3	断路器/Circuit-breaker	TECO	BM-63C/3006S	6A	1	YE40300603000								
5	Q4	断路器/Circuit-breaker	TECO	BM-63C/3016S	16A	1	YE40301603000								
6	K1	交流接触器/Contactor	SIEMENS	3RT6015-1ANZ1	7A 220V 50/60Hz	1	YE00601521000								
7	K2	交流接触器/Contactor	SIEMENS	3RT6016-1ANZ1	9A 220V 50/60Hz	1	YE00601621000								
8	K3	交流接触器/Contactor	SIEMENS	3RT6018-1ANZ1	16A 220V 50/60Hz	1	YE00601800000								
9	K4	中间继电器/Middle relay	WEIDMULLER	DRM270730LT	230V 50/60Hz	1	YE03270700000								
10	U	直流电源/DC power	MEAN WELL	NES-35-24	OUT=DC24V 15A	1	YE71352400100		B						
11	F1	热过载继电器/Overload relay	SIEMENS	3RU6116-0GB0	0.45-0.63A	1	YE01161450000								
12	F2	热过载继电器/Overload relay	SIEMENS	3RU6116-1HB0	5.5-8A	1	YE01160550000								
13	FU1	熔断器座 /Fuse base	CHNT	RT28-32	2P	1	YE41032200000								
14		熔断器芯 /Fuse core	CHNT	10×38 500V	2A	2	YE46002000000								
15	S3	露点变送器/Dew-point Transducer	CS	CS 217-0EM	POWER=24VDC OUT=4-20mA	1	-----	(1)(2)							
16	S4	温度保护器/Temperature protector	EGO	--	115-320°	1	-----	(1)							
17	S5	热电偶/Thermocouple	SHINI	ST-K	K	1	-----	(1)							
18	PCB	两机一体SDI-U控制器	PUMP	K.SF878500A.04	-----	1	YE80878500300								
19	H1	蜂鸣器/Buzzer	HITPOINT	PK-35A	220V AC/DC	1	YE84003500200		C						
20	H2	警报指示灯/Alarm indicator	SHINI	LED-3051	230VAC 50Hz	1	YE83305100200	(1)							
21	FM	风扇/Fan	SUNON	DP-200A	230VAC 40W	1	-----	(1)							
22	Y1,Y2,Y3	电磁阀/Solenoid valve	FESTO	MSFW-230-50/60	230VAC 50/60Hz	3	-----	(1)							
23	M1	风机/Blower	SHINI	----	230V 50/60Hz 0.12KW	1	-----	(1)							
24	M2	风机/Blower	SHINI	----	230V 50/60Hz 15KW	1	-----	(1)							
25	EH1	电热器/Heater	SHINI	----	230V 50/60Hz 3.9KW	1	-----	(1)							
整机版本 Ver.C															
注: (1)表示非电控箱内材料; (2)表示选配露点计															
D		制图	版号	标题	图号	比例		第 4 张							
		设计	核 准	SDL-80U/120U 电气元件明细表一	SDL-80U/120U- CE-230V-F-4	标准 CE		共 5 张							
		校对	日期	SHINI 信易电热机械股份有限公司 Shini Plastics Technologies, Inc.		机器电压		230V							
标记		更改前	更改后	更改人	日期	机器频率		50Hz							
1	2	3	4	5	6	7	8								

1		2		3		4		5		6		7		8	
序号/NO	符号/Symbol	名称/Name	制造商/Manufacturer	型号/Type	规格/Specification	数量/Number	物料编号/Material number	备注/Remark							
26	X1	端子排/Terminal board	----	4mm ²	----	12	YE600004.03200								
27			----	4mm ² PE	----	4	YE600004.03500								
28	X2	端子排/Terminal board	----	2.5mm ²	----	14	YE60002503200								
29			----	2.5mm ² PE	----	3	YE60002503400								
30			----	2.5mm ²	----	2	YE60002503200	(2)							
31			----	2.5mm ²	----	2	YE60002503200	(3)							
32	X3	端子/Terminal	----	2.5mm ²	----	6	YE60002503200								
33	X4,X5	重载插头/Heavy duty connector	SIBAS	HDC-HA-004.1	4P 10A	2	YE6804.1000100	(1)							
34	S10	通信接口板DS-485 (德Dsub-9pin接口)	--	--	--	1	YE9004.8501200	(1)							
35		外壳DS485 (SAL-700G-A-19) 0版	--	--	--	1	YR4-004.8500000	(1)							
36		终端面定件/DS系列 (霍尼韦尔)	--	--	--	5	YE60000003900								
B															
C															
D															
整机版本 Ver.C 注: (1)表示非电控箱内材料; (2)表示选配露点计; (3)表示选配无热再生装置。															
			制图		F		标题		图号		比例		第 5 张		
			设计		核 准		SDL-80U/120U		SDL-80U/120U- CE-230V-F-5		标准 CE		共 5 张		
			校对		日期		电气元件明细表二		20170830		机器电压		230V		
标记 更改前			更改后		更改人		日期		审核		机器频率		50Hz		
1	2	3	4	5	6	7	8								



信易电热机械股份有限公司
Shini Plastics Technologies, Inc.

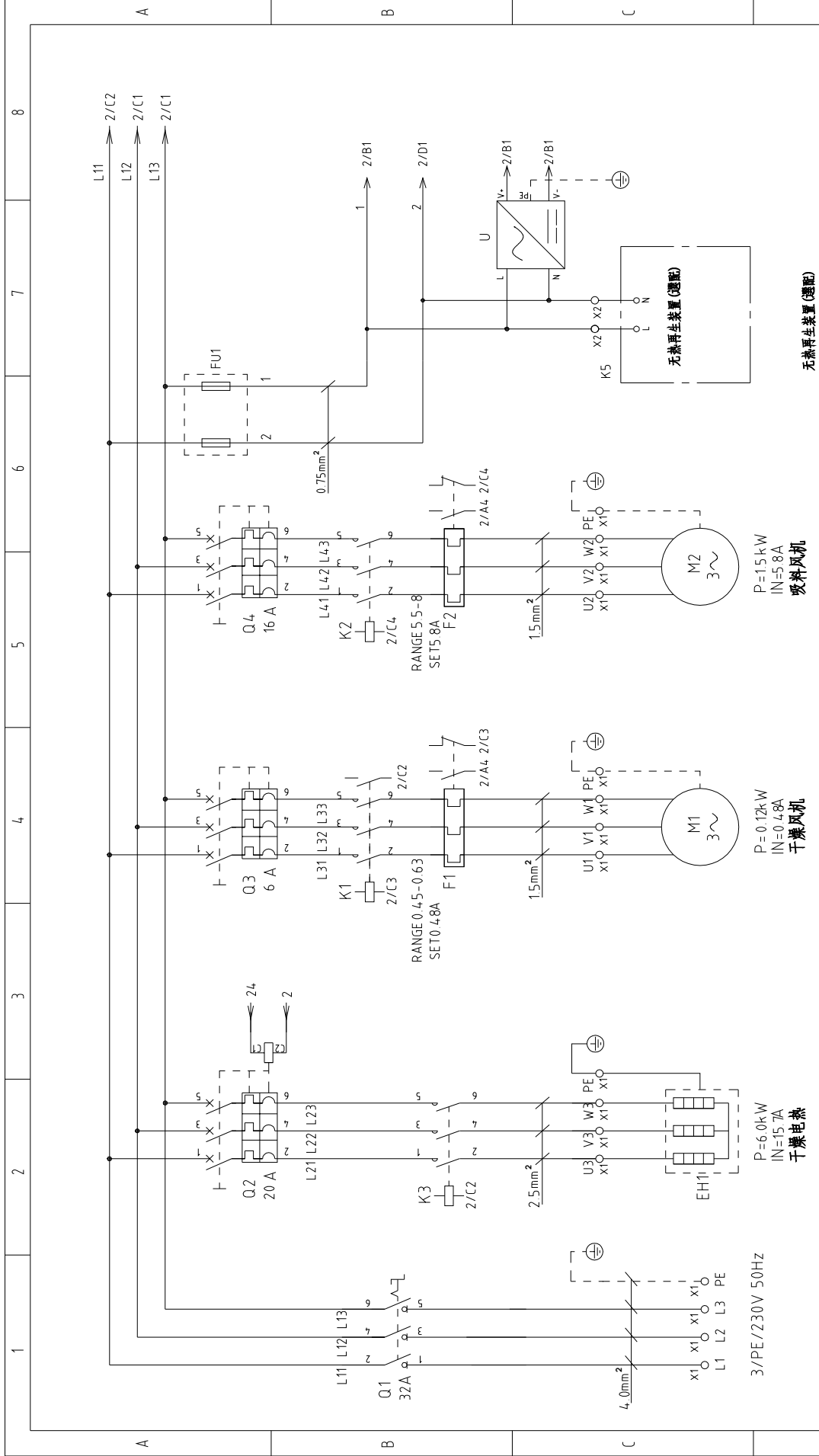

整机版本 Ver.D

图号 SDL-160U- CE-230V-F-1	标题 SDL-160U 主电路图	第 1 张 共 5 张	比例 标准 CE 机器电压 230V 机器频率 50Hz
制图 设计 校对 审核	版号 核 准 日期 20170830	更改后 更改人 更改日期	更改前 更改人 更改日期
信易电热机械股份有限公司 Shini Plastics Technologies, Inc.		图号 SDL-160U- CE-230V-F-1	比例 标准 CE 机器电压 230V 机器频率 50Hz

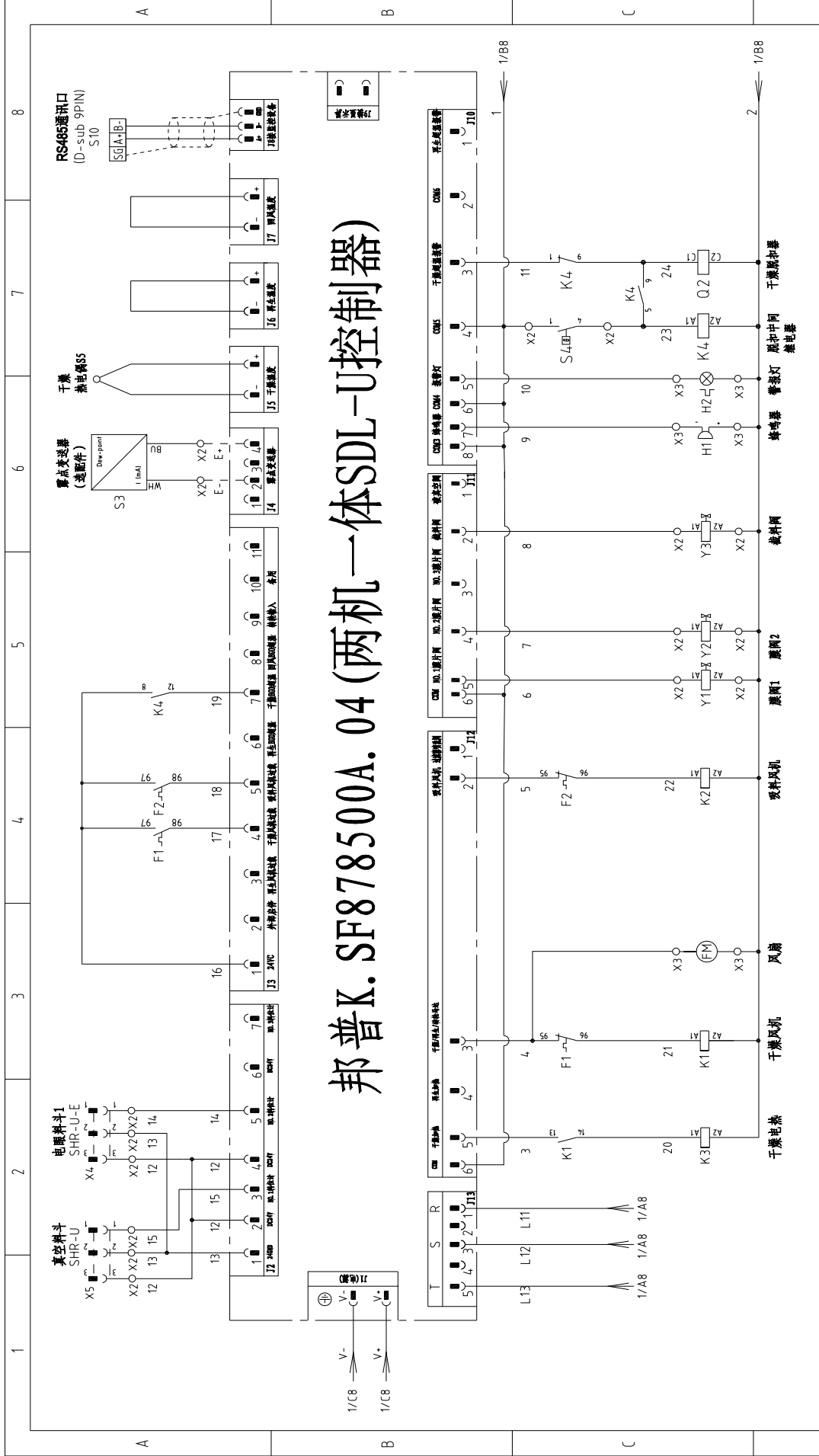

邦普K. SF878500A. 04 (两机一体SDL-U控制器)

整机版本 Ver.D	制图	版号	标题	图号	比例	张数
	设计	核 准	SDL-160U 控制电路图	SDL-160U- CE-230V-F-2	标准	第 2 张
校对	日期	日期	日期	日期	机器电压	共 5 张
更改前	更改后	更改人	更改后	更改日期	230V	50Hz
标记	更改后	更改日期	更改日期	更改日期	机器频率	8



信易电热机械股份有限公司
Shini Plastics Technologies, Inc.

1 2 3 4 5 6 7 8

A B C D

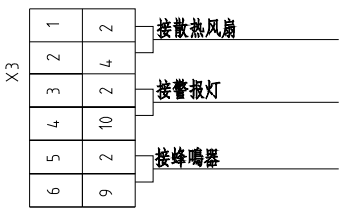
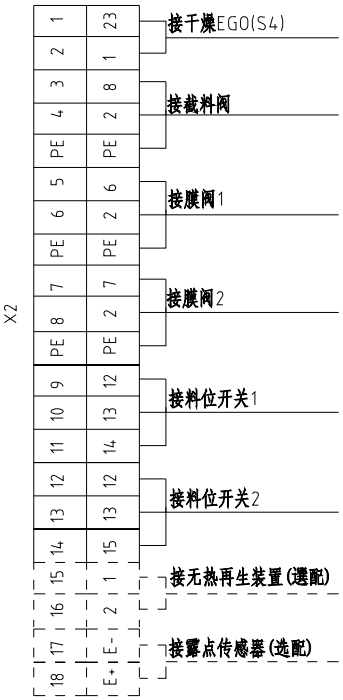
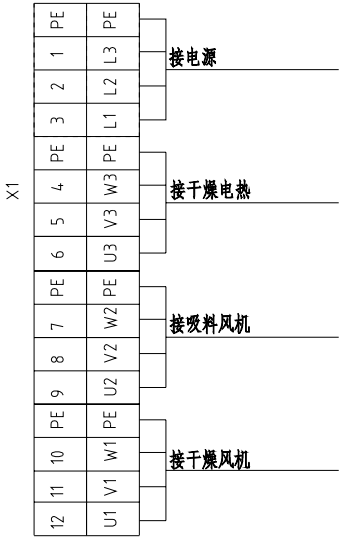
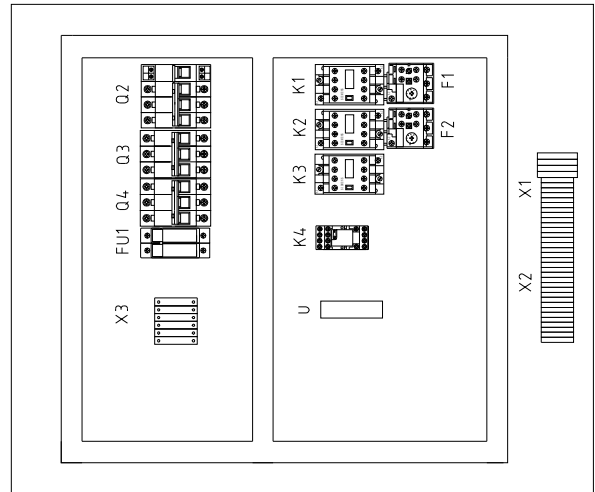
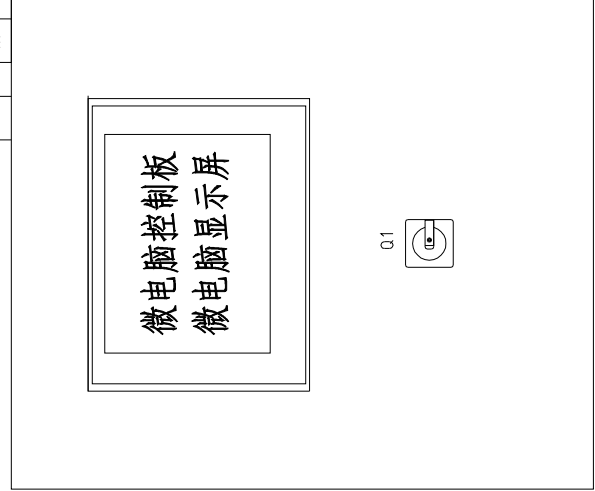

整机版本 Ver.D

图号	SDL-160U-CE-230V-F-3	比例	第 3 张
标题	SDL-160U 电气元件布置图	标准	共 5 张
版号	F	机器电压	230V
制图	设计	机器频率	50Hz
设计	校对		
日期	20170830		
更改后	更改人		
更改前	日期		
标记	更改后		
	更改前		



1 2 3 4 5 6 7 8

1		2		3		4		5		6		7		8	
序号/NO	符号/Symbol	名称/Name	制造商/Manufacturer	型号/Type	规格/Specification	数量/Number	物料编号/Material number	备注/Remark							
1	Q1	主电源开关/Main switch	EATON	P1-32/EA/SVB	32A	1	YE10323200000								
2	Q2	断路器/Circuit-breaker	TECO	BM-63C/3020S	20A	1	YE40302003000								
3		励磁脱扣器/Excitation release	TECO	MX	230V 50/60Hz	1	YE40023560000								
4	Q3	断路器/Circuit-breaker	TECO	BM-63C/3006S	6A	1	YE40300603000								
5	Q4	断路器/Circuit-breaker	TECO	BM-63C/3016S	16A	1	YE40301603000								
6	K1	交流接触器/Contactor	SIEMENS	3RT6015-1AN21	7A 220V 50/60Hz	1	YE00601521000								
7	K2	交流接触器/Contactor	SIEMENS	3RT6016-1AN21	9A 220V 50/60Hz	1	YE00601621000								
8	K3	交流接触器/Contactor	SIEMENS	3RT6026-1AN20	25A 220V 50/60Hz	1	YE00602622000								
9	K4	中间继电器/Middle relay	WEIDMULLER	DRM270730LT	230V 50/60Hz 12A	1	YE03270700000								
10	U	直流电源/DC power	MEAN WELL	NES-35-24	OUT=DC24V 15A	1	YE71352400100								
11	F1	热过载继电器/Overload relay	SIEMENS	3RU6116-0GB0	0.45-0.63A	1	YE01161450000								
12	F2	热过载继电器/Overload relay	SIEMENS	3RU6116-1HB0	5.5-8A	1	YE01160550000								
13	FU1	熔断器座 /Fuse base	CHNT	RT28-32	2P	1	YE41032200000								
14		熔断器芯 /Fuse core	CHNT	10x38 500V	2A	2	YE46002000000								
15	S3	露点变送器/Dew-point Transducer	CS	CS 217-0EM	POWER=24VDC OUT=4-20mA	1	-----	(1)(2)							
16	S4	温度保护器/Temperature protector	EGO	--	115-320°	1	-----	(1)							
17	S5	热电偶/Thermocouple	SHINI	ST-K	K	1	-----	(1)							
18	PCB	两机一体SDI-控制柜	PUMP	K SF878500A 04	-----	1	YE80878500300								
19	H1	蜂鸣器/Buzzer	HITPOINT	PK-35A	220V AC/DC	1	YE84003500200								
20	H2	警报指示灯/Alarm indicator	SHINI	LED-3051	230VAC 50Hz	1	YE83305100200	(1)							
21	FM	风扇/Fan	SUNON	DP-200A	230VAC 40W	1	-----	(1)							
22	Y1,Y2,Y3	电磁阀/Solenoid valve	FESTO	MSFW-230-50/60	230VAC 50/60Hz	3	-----	(1)							
23	M1	风机/Blower	SHINI	----	230V 50/60Hz 0.12KW	1	-----	(1)							
24	M2	风机/Blower	SHINI	----	230V 50/60Hz 15KW	1	-----	(1)							
25	EH1	电热器/Heater	SHINI	----	230V 50/60Hz 6.0KW	1	-----	(1)							
整机版本 Ver.D															
注: (1) 表示非电控箱内材料; (2) 表示选配露点计															
				制图	标题		图号		比例		第 4 张				
				设计	SDL-160U		SDL-160U-CE-230V-F-4		标准		共 5 张				
				校对	电气元件明细表一				机器电压		230V				
				审核	SHINI				机器频率		50Hz				
标记	更改前	更改后	更改人	日期	日期	日期	日期	日期	日期	日期	日期	日期	日期	日期	日期



信易电热机械股份有限公司
Shini Plastics Technologies, Inc.

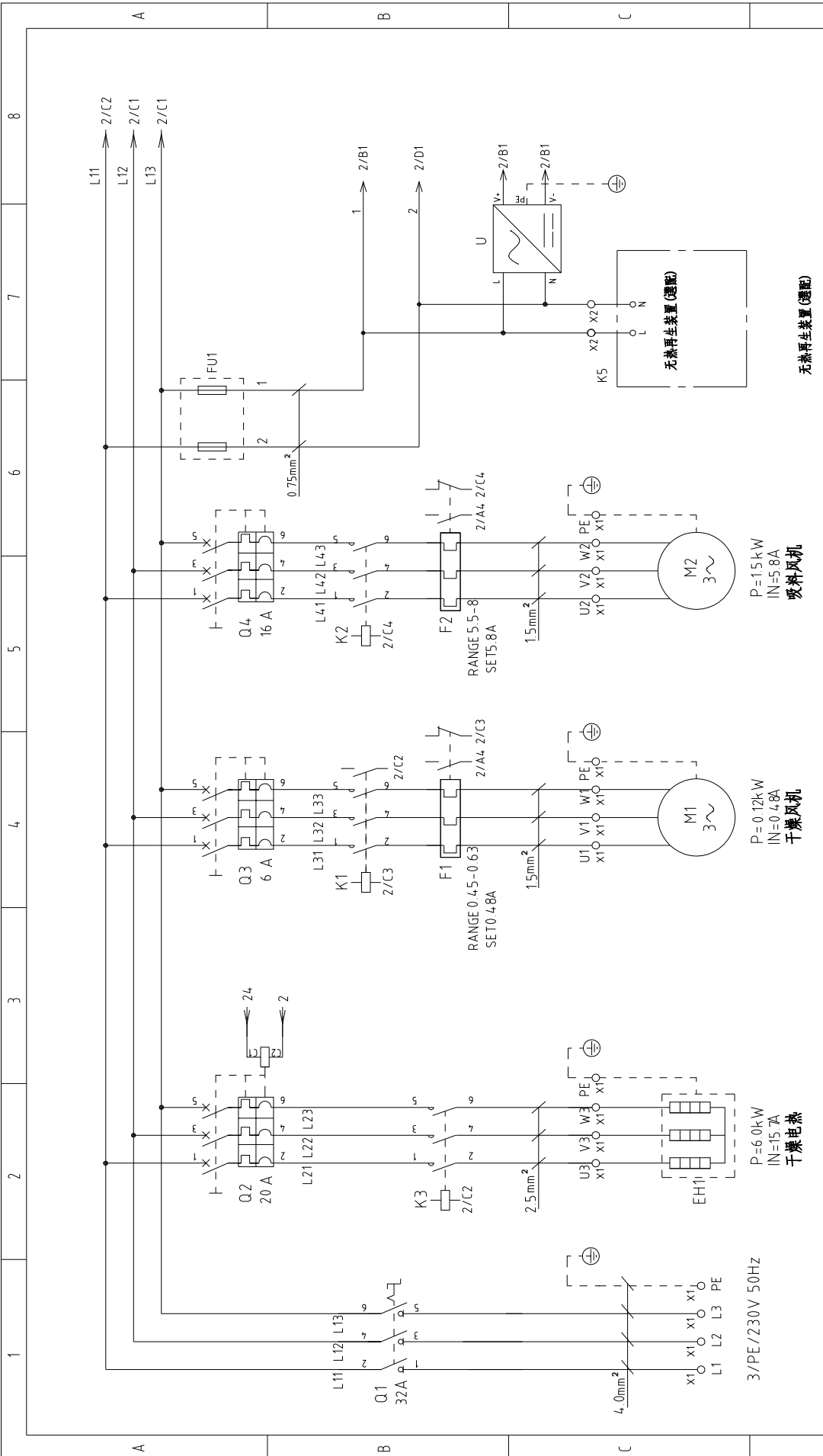

SDL-230U 整机版本 Ver.B | SDL-230U-HD 整机版本 Ver.C

1	2	3	4	5	6	7	8
A		B		C		D	
制图	版号	标题	图号	比例	第 1 张		
设计	F	SDL-230U	SDL-230U- CE-230V-F-1	标准	共 5 张		
校对	核准	主电路图		标准	CE		
审核	日期	20170830		机器电压	230V		
更改前	更改后	更改人	日期	机器频率	50Hz		
1	2	3	4	5	6	7	8



无热再生装置 (选配)

P=15kW
IN=5.8A
塑料风机

P=0.12kW
IN=0.48A
干燥风机

P=6.0kW
IN=15.7A
干燥电热

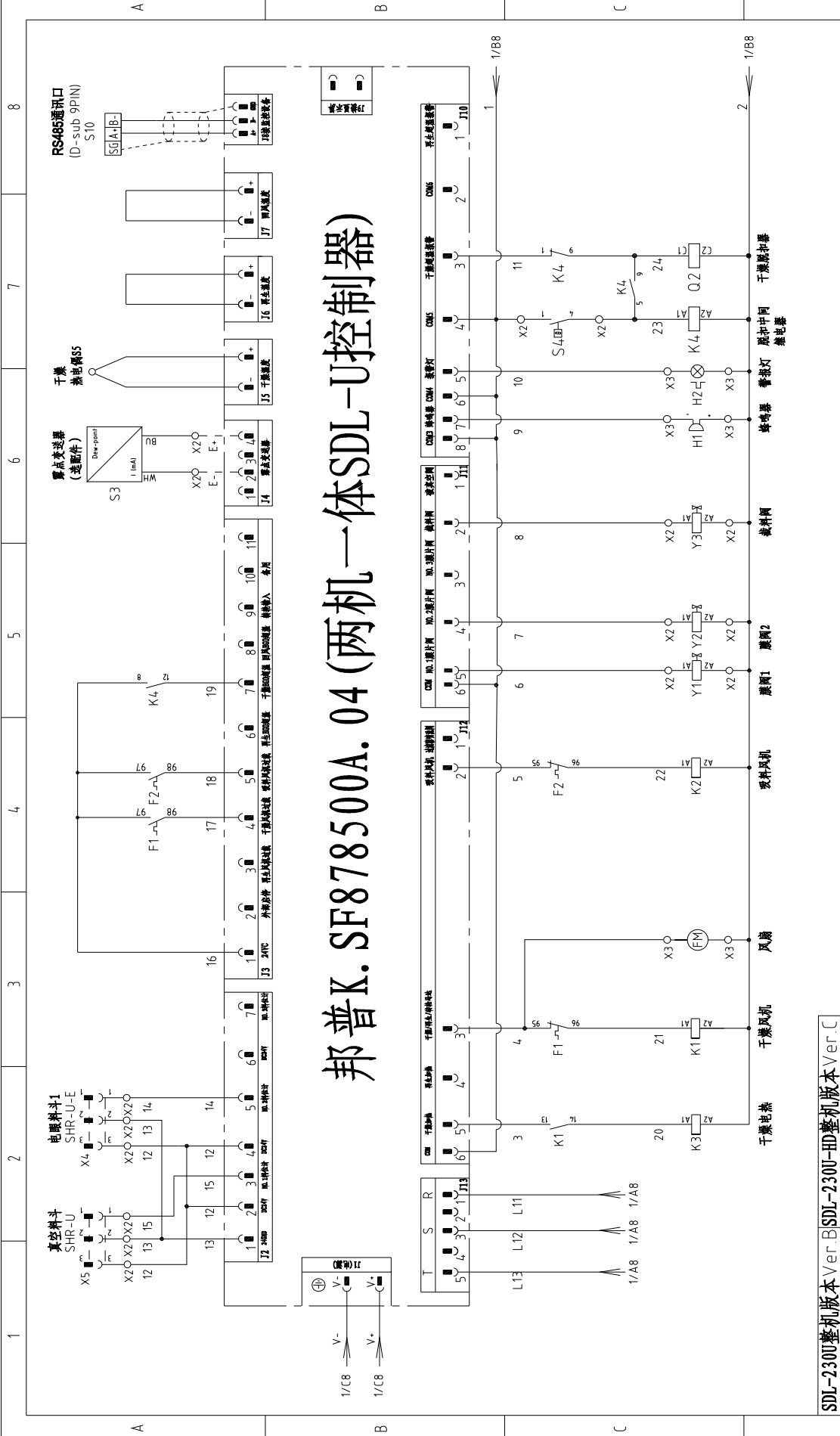

邦普K.SF878500A.04 (两机一体SDL-U控制器)

SDL-230U整机版本Ver.B | SDL-230U-HD整机版本Ver.C

制图	版号	F	图号	SDL-230U- CE-230V-F-2		第 2 张
	设计	核 准		标准	CE	共 5 张
校对	日期	20170830	比例	1:1	机器电压	230V
审核	日期		比例	1:1	机器频率	50Hz
更改前	更改后	更改人				
更改后	更改后	更改人	信易电热机械股份有限公司 Shini Plastics Technologies, Inc.			

1 2 3 4 5 6 7 8

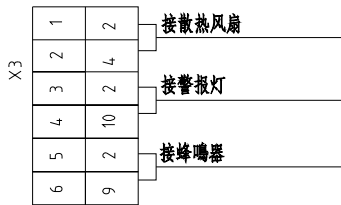
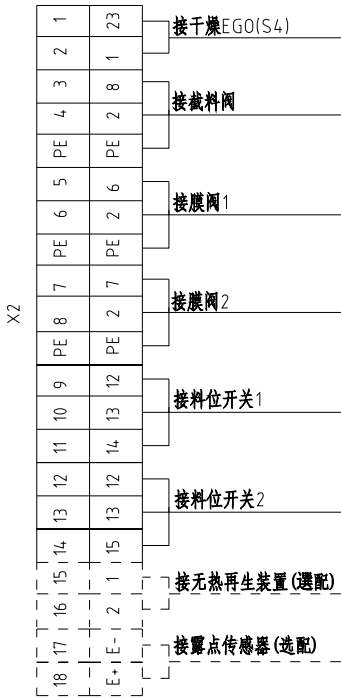
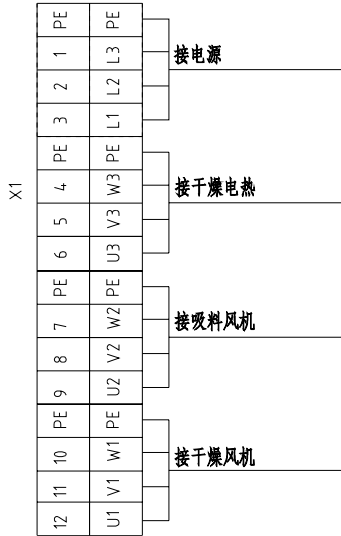
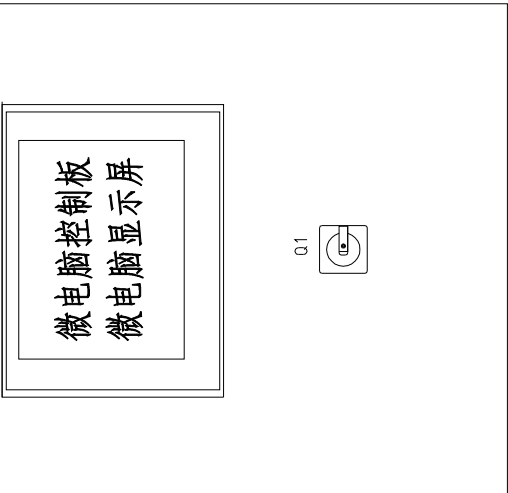
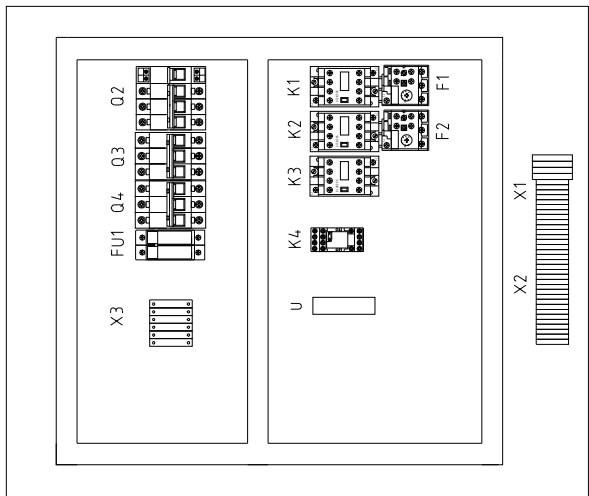

SDL-230U整机版本Ver.B SDL-230U-HD整机版本Ver.C

标题		图号	比例		第 3 张
SDI-230U 电气元件布置图		SDL-230U- CE-230V-F-3	标准	CE	共 5 张
版号		F	机器电压		230V
核 准			机器频率		50Hz
制 图	设计	校 对	审 核	日期	
			更改后	更改前	
			更改人	更改日期	
日期	20170830				



1 2 3 4 5 6 7 8

1	2	3	4	5	6	7	8	
序号/NO	符号/Symbol	名称/Name	制造商/Manufacturer	型号/Type	规格/Specification	数量/Number	物料编号/Material number	备注/Remark
1	Q1	主电源开关/Main switch	EATON	P1-32/EA/SVB	32A	1	YE10323200000	
2	Q2	断路器/Circuit-breaker	TECO	BM-63C/3020S 3P	20A	1	YE40302003000	
3		励磁释放器/Excitation release	CHINT	MX	230V 50/60Hz	1	YE40023560000	A
4	Q3	断路器/Circuit-breaker	TECO	BM-63C/3006S 3P	6A	1	YE40300603000	
5	Q4	断路器/Circuit-breaker	TECO	BM-63C/3016S 3P	16A	1	YE40301603000	
6	K1	交流接触器/Contactor	SIEMENS	3RT6015-1ANZ1	7A 220V 50/60Hz	1	YE00601521000	
7	K2	交流接触器/Contactor	SIEMENS	3RT6016-1ANZ1	9A 220V 50/60Hz	1	YE00601621000	
8	K3	交流接触器/Contactor	SIEMENS	3RT6026-1ANZ0	25A 220V 50/60Hz	1	YE00602622000	
9	K4	中间继电器/Middle relay	WEIDMULLER	DRM270730LT	230V 50/60Hz 12A	1	YE03270700000	
10	U	直流电源/DC power	MEAN WELL	NES-35-24	OUT=DC24V 15A	1	YE71352400100	
11	F1	热过载继电器/Overload relay	SIEMENS	3RU6116-0GB0	0.45-0.63A	1	YE01161450000	B
12	F2	热过载继电器/Overload relay	SIEMENS	3RU6116-1HB0	5.5-8A	1	YE01160550000	
13	FU1	熔断器座 /Fuse base	CHNT	RT28-32	2P	1	YE41032200000	
14		熔断器芯 /Fuse core	CHNT	10x38 500V	2A	2	YE46002000000	
15	S3	露点变送器/Dew-point Transducer	CS	CS 217-0EM	POWER=24VDC OUT=4-20mA	1	-----	(1)(2)
16	S4	温度保护器/Temperature protector	EGO	--	115-320°	1	-----	(1)
17	S5	热电阻/Thermocouple	SHINI	ST-K	K	1	-----	(1)
18	PCB	两机一体SDI-UI控制器	PUMP	K.SF878500A.04	-----	1	YE80878500300	
19	H1	蜂鸣器/Buzzer	HITPOINT	PK-35A	220V AC/DC	1	YE84003500200	C
20	H2	警报指示灯/Alarm indicator	SHINI	LED-3051	230VAC 50Hz	1	YE83305100200	(1)
21	FM	风扇/Fan	SUNON	DP-200A	230VAC 40W	1	YM60121200400	(1)
22	Y1,Y2,Y3	电磁阀/Solenoid valve	FESTO	MSFW-230-50/60	230VAC 50/60Hz	3	-----	(1)
23	M1	风机/Blower	SHINI	----	230V 50/60Hz 0.12KW	1	----	(1)
24	M2	风机/Blower	SHINI	----	230V 50/60Hz 15KW	1	----	(1)
25	EH1	电热器/Heater	SHINI	----	230V 50/60Hz 6.0KW	1	----	(1)

SDL-230U整机版本Ver.B SDL-230U-HD整机版本Ver.C 注: (1)表示非电控箱内材料; (2)表示选配露点计.

D		标题		图号		比例		第 4 张	
		SDL-230U		SDI-230U-CE-230V-F-4		标准 CE		共 5 张	
		电气元件明细表一				机器电压		230V	
		SHINI		SHINI		机器频率		50Hz	
标记	更改前	更改后	更改人	日期	日期	日期	日期	日期	日期
				20170830					



信易电热机械股份有限公司
Shini Plastics Technologies, Inc.

1		2		3		4		5		6		7		8																																																																																																		
序号/NO	符号/Symbol	名称/Name	制造商/Manufacturer	型号/Type	规格/Specification	数量/Number	物料编号/Material number	备注/Remark																																																																																																								
26	X1	端子排/Terminal board	----	4.0mm ²	----	12	YE600004.03200																																																																																																									
27			----	4.0mm ² PE	----	4	YE600004.03500																																																																																																									
28	X2	端子排/Terminal board	----	2.5mm ²	----	14	YE60002503200																																																																																																									
29			----	2.5mm ² PE	----	3	YE60002503400																																																																																																									
30			----	2.5mm ²	----	2	YE60002503200	(2)																																																																																																								
31			----	2.5mm ²	----	2	YE60002503200	(3)																																																																																																								
32	X3	端子/Terminal	----	2.5mm ²	----	6	YE60002503200																																																																																																									
33	X4, X5	重载接头/Heavy duty connector	SIBAS	HDC-HA-004.1	4P 10A	2	YE6804.1000100	(1)																																																																																																								
34	S10	通信接口板RS-485 (德Dsub-9pin接口)	--	--	--	1	YE9004.8501200	(1)																																																																																																								
35		外壳RS485 (SAL-7000-A-19) 0版	--	--	--	1	YR4.004.8500000	(1)																																																																																																								
36		终端固定件B/GX系列 (霍尼韦尔)	--	--	--	5	YE60000003900																																																																																																									
B																																																																																																																
C																																																																																																																
D																																																																																																																
SDL-230U整机版本 Ver.B/SDL-230U-HD整机版本 Ver.C 注: (1) 表示非电控箱内材料; (2) 表示选配露点计; (3) 表示选配无热再生装置。																																																																																																																
<table border="1" style="width: 100%;"> <tr> <td colspan="3" style="text-align: center;">标题</td> <td colspan="3" style="text-align: center;">图号</td> <td colspan="3" style="text-align: center;">比例</td> <td colspan="3" style="text-align: center;">第 5 张</td> </tr> <tr> <td colspan="4" style="text-align: center;">SDI-230U</td> <td colspan="4" style="text-align: center;">SDL-230U-CE-230V-F-5</td> <td colspan="4" style="text-align: center;">标准 CE</td> <td colspan="3" style="text-align: center;">共 5 张</td> </tr> <tr> <td colspan="4" style="text-align: center;">电气元件明细表二</td> <td colspan="3" style="text-align: center;">核准</td> <td colspan="3" style="text-align: center;">日期</td> <td colspan="3" style="text-align: center;">机器电压 230V</td> </tr> <tr> <td colspan="4" style="text-align: center;">校对</td> <td colspan="3" style="text-align: center;">日期</td> <td colspan="3" style="text-align: center;">审核</td> <td colspan="3" style="text-align: center;">机器频率 50Hz</td> </tr> <tr> <td colspan="3" style="text-align: center;">更改前</td> <td colspan="3" style="text-align: center;">更改后</td> <td colspan="3" style="text-align: center;">更改人</td> <td colspan="3" style="text-align: center;">日期</td> <td colspan="3" style="text-align: center;">20170830</td> </tr> <tr> <td colspan="15" style="text-align: center;"> <table border="1" style="width: 100%;"> <tr> <td colspan="7" style="text-align: center;"> </td> <td colspan="8" style="text-align: center;"> 信易电热机械股份有限公司 Shini Plastics Technologies, Inc. </td> </tr> </table> </td> </tr> </table>															标题			图号			比例			第 5 张			SDI-230U				SDL-230U-CE-230V-F-5				标准 CE				共 5 张			电气元件明细表二				核准			日期			机器电压 230V			校对				日期			审核			机器频率 50Hz			更改前			更改后			更改人			日期			20170830			<table border="1" style="width: 100%;"> <tr> <td colspan="7" style="text-align: center;"> </td> <td colspan="8" style="text-align: center;"> 信易电热机械股份有限公司 Shini Plastics Technologies, Inc. </td> </tr> </table>																						信易电热机械股份有限公司 Shini Plastics Technologies, Inc.							
标题			图号			比例			第 5 张																																																																																																							
SDI-230U				SDL-230U-CE-230V-F-5				标准 CE				共 5 张																																																																																																				
电气元件明细表二				核准			日期			机器电压 230V																																																																																																						
校对				日期			审核			机器频率 50Hz																																																																																																						
更改前			更改后			更改人			日期			20170830																																																																																																				
<table border="1" style="width: 100%;"> <tr> <td colspan="7" style="text-align: center;"> </td> <td colspan="8" style="text-align: center;"> 信易电热机械股份有限公司 Shini Plastics Technologies, Inc. </td> </tr> </table>																						信易电热机械股份有限公司 Shini Plastics Technologies, Inc.																																																																																										
							信易电热机械股份有限公司 Shini Plastics Technologies, Inc.																																																																																																									