

整機版本 Ver.C

Title		SGB-1200-4		Drawing NO.		Page 1	
Electrical Diagram 1		SGB-1200-4-CE-230V-A-1		Standard		CE	
Version		A		Voltage		3/230V	
Approved by		Date		Frequency		50/60Hz	
Date		20170608		Totally		10	
Pages		3		Voltage		3/230V	
Frequency		50/60Hz		Frequency		50/60Hz	

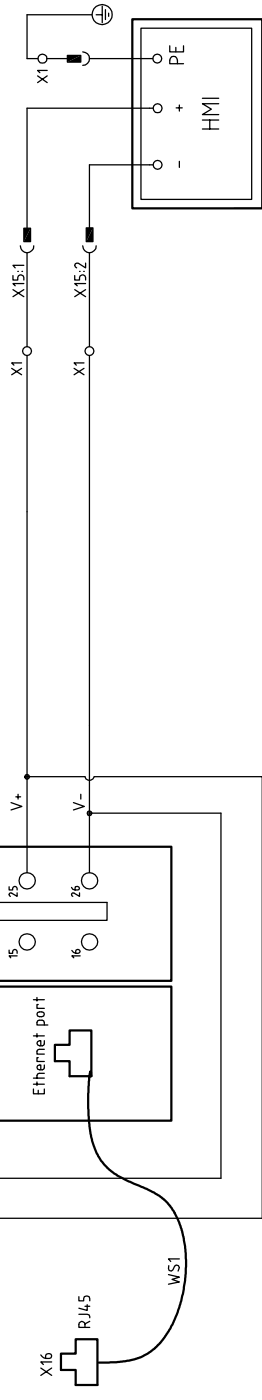

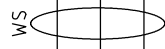
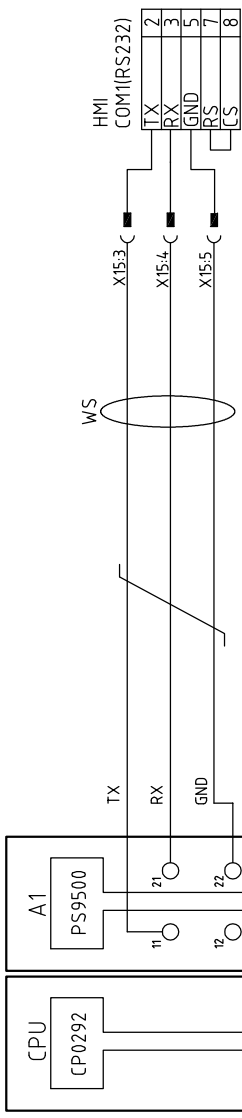
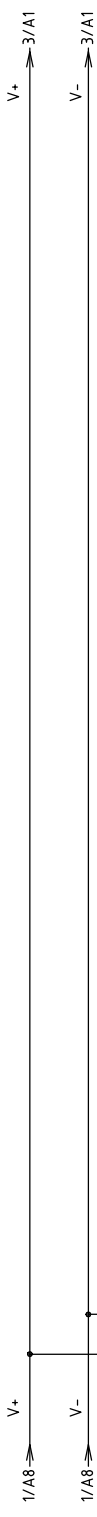

整机版本 Ver.C

Title		Drawing NO.		Scale		Page 2	
SGB-1200-4		SGB-1200-4-CE-230V-A-2		Standard		CE	
Electrical Diagram 2				Voltage		3/230V	
				Frequency		50/60HZ	
Version		Approved by		Totally		10	
A				Pages		3/230V	
Date		Date		Voltage		50/60HZ	
20170608		20170608		Frequency		50/60HZ	
Mark		Modified by		Voltage		50/60HZ	
		Modify date		Frequency		50/60HZ	
				Voltage		50/60HZ	
				Frequency		50/60HZ	





- Mixing hopper upper material level switch
- Storage tank upper material level switch
- Safety door
- Hopper 1 low material level switch (optional)
- Hopper 3 low material level switch (optional)
- Phase sequence protector
- Air pressure switch
- Hopper 2 low material level switch (optional)
- Hopper 4 (low material level switch (optional)
- Overload detecting of suction motor
- Overload detecting of mixing motor

整机版本 Ver.C

Title		SGB-1200-4		Drawing NO.		Page 3	
Version		A		Standard		CE	
Electrical Diagram 3		SGB-1200-4-CE-230V-A-3		Voltage		3/230V	
Date		20170608		Frequency		50/60HZ	
Designer		Approved by		Totally		10 Pages	
Proofread by		Date		Voltage		3/230V	
Checked by		Date		Frequency		50/60HZ	
Modify date		Date		Voltage		3/230V	
Modified by		Date		Frequency		50/60HZ	
Before modification		Date		Voltage		3/230V	
After modification		Date		Frequency		50/60HZ	
Mark		Date		Voltage		3/230V	
2		4		6		8	



1 2 3 4 5 6 7 8

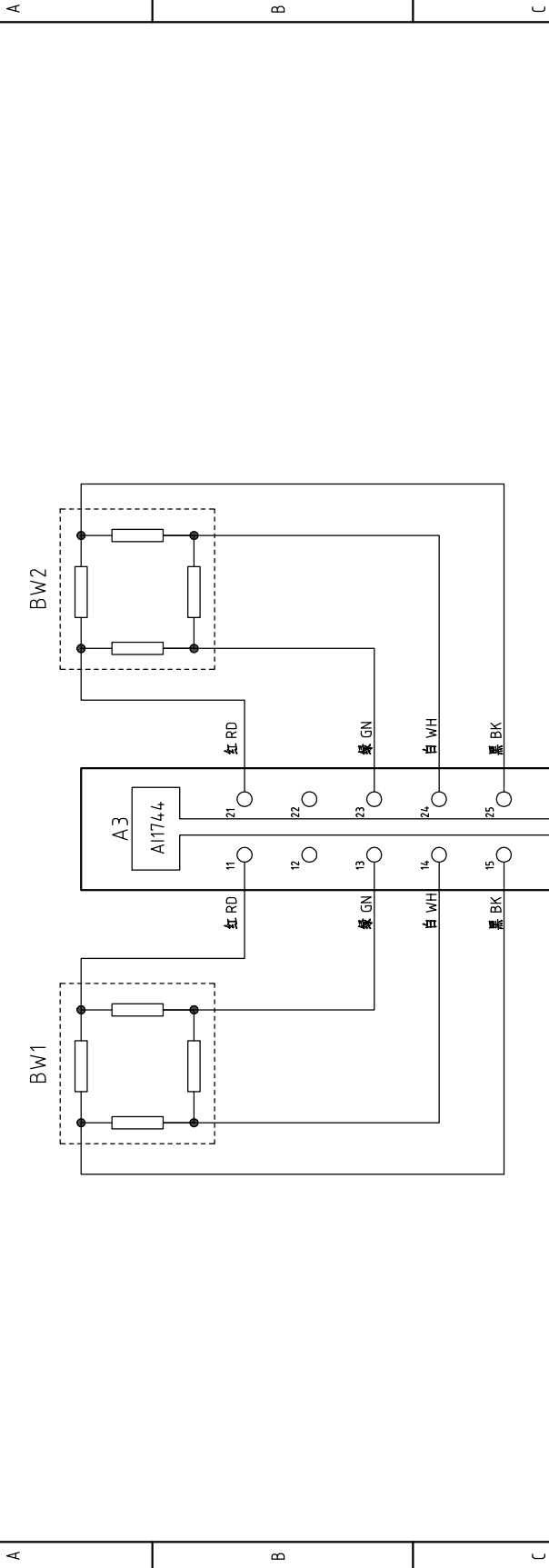

整机版本 Ver.C

Title		SGB-1200-4		Drawing NO.		Scale		Page	
Version		A		SGB-1200-4-CE-230V-A-4		Standard		4	
Drawer		Designer		Electrical Diagram 4		Voltage		10	
Proofread by		Approved by		SHINI		Frequency		3/230V	
Checked by		Date		信易塑料机械股份有限公司		Frequency		50/60HZ	
Modified by		Date		Shini Plastics Technologies, Inc.		Frequency		8	
Mark		Date		20170608		Frequency		8	
Before modification		Date		20170608		Frequency		8	
After modification		Date		20170608		Frequency		8	

3/A8 → V- 6/A1

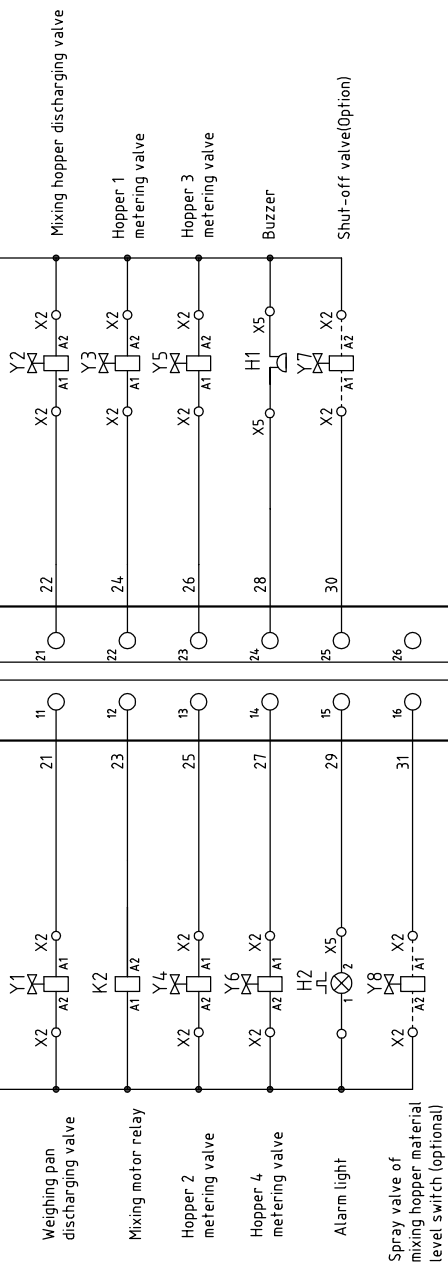
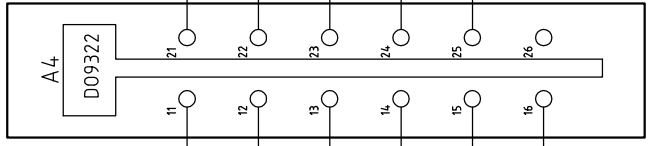

整机版本 Ver.C

Title		SGB-1200-4		Drawing NO.		Scale		Page 5	
Electrical Diagram 5		SGB-1200-4-CE-230V-A-5		Standard		CE		Totally 10 Pages	
Date		20170608		Voltage		3/230V		Frequency	
Date		20170608		Frequency		50/60HZ			



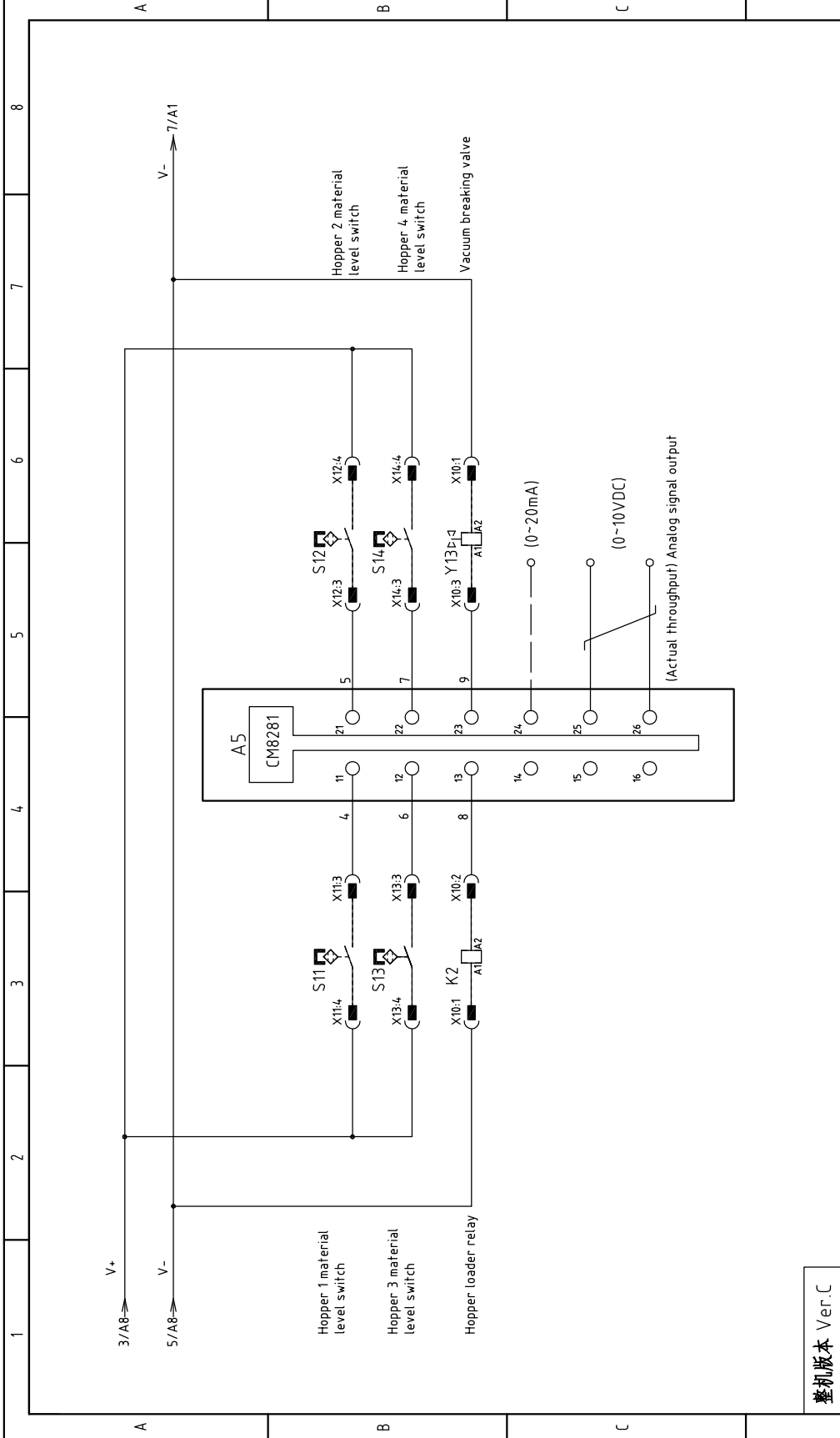

整机版本 Ver.C

Title		Version		Drawer		Scale		Page	
SGB-1200-4		A				Standard		6	
Drawing NO.		Approved by		Designer		Voltage		Totally	
SGB-1200-4-CE-230V-A-6						3/230V		10	
Electrical Diagram 6		Date		Proofread by		Frequency		Pages	
		20170608				50/60HZ		3/230V	
Mark		Modified by		Checked by		SHINI		SHINI	
Before modification		After modification		Modify date		信易塑料机械股份有限公司		SHINI	
						Shini Plastics Technologies, Inc.		SHINI	
1		2		3		4		5	
6		7		8		9		10	

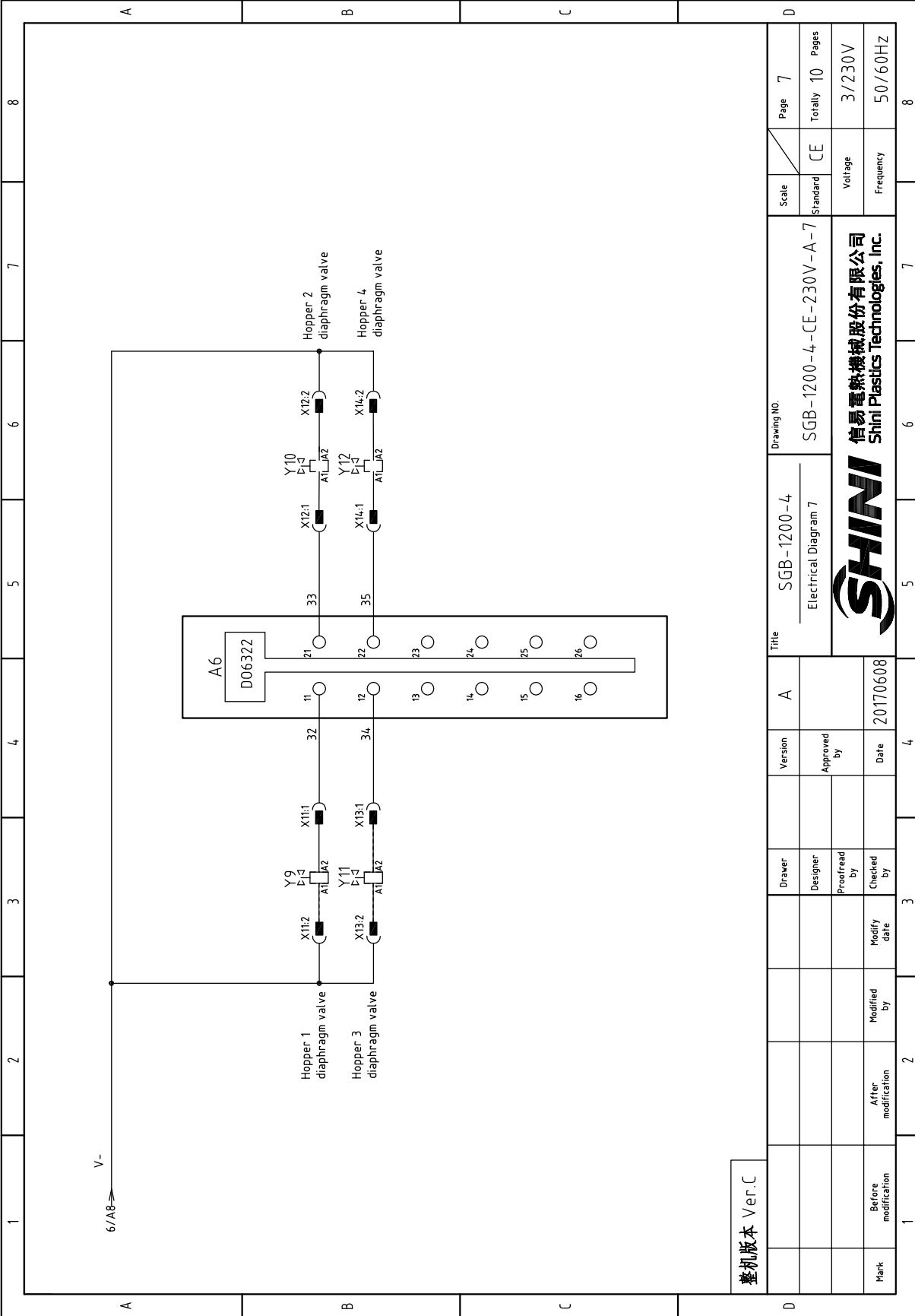

整机版本 Ver.C

Title		SGB-1200-4		Drawing NO.		Page 7	
Version		A		Standard		CE	
Designer		Approved by		Voltage		3/230V	
Proofread by		Date		Frequency		50/60HZ	
Checked by		20170608		Standard		CE	
Modified by				Voltage		3/230V	
Modify date				Frequency		50/60HZ	
Before modification				Standard		CE	
After modification				Voltage		3/230V	
Mark				Frequency		50/60HZ	
Title		SGB-1200-4		Drawing NO.		Page 7	
Version		A		Standard		CE	
Designer		Approved by		Voltage		3/230V	
Proofread by		Date		Frequency		50/60HZ	
Checked by		20170608		Standard		CE	
Modified by				Voltage		3/230V	
Modify date				Frequency		50/60HZ	
Before modification				Standard		CE	
After modification				Voltage		3/230V	
Mark				Frequency		50/60HZ	

**SHINI**  
信易电热机械股份有限公司  
Shini Plastics Technologies, Inc.

Electrical Diagram 7  
SGB-1200-4-CE-230V-A-7

1 2 3 4 5 6 7 8

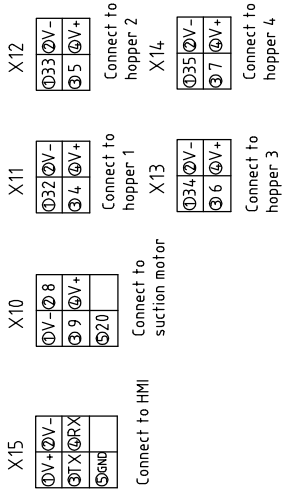
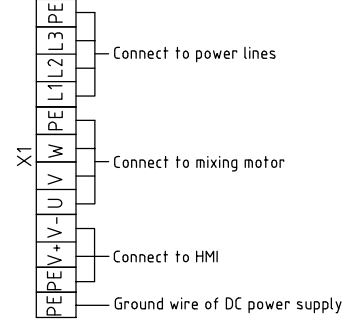
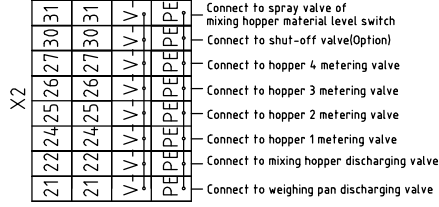
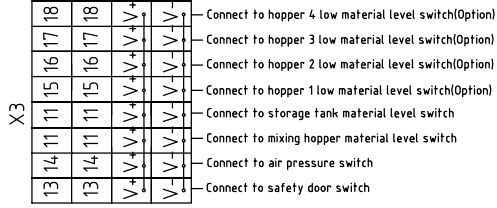
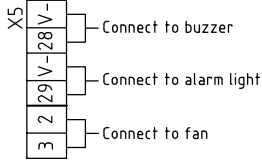
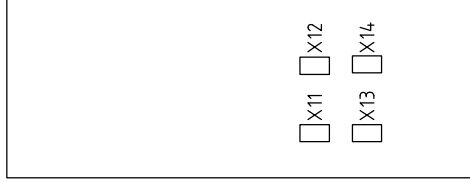
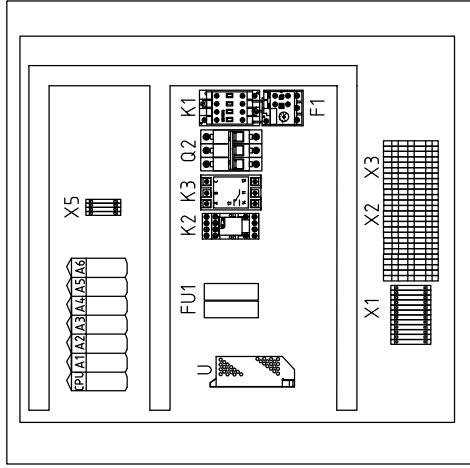

整机版本 Ver.C

Title		SGB-1200-4		Drawing NO.		Page 8	
Version		A		SGB-1200-4-CE-230V-A-8		Scale	
Designer		Approved by		Electrical Components Layout		Standard	
Proofread by		Date		SHINI		Voltage	
Checked by		20170608		信易塑料机械股份有限公司 Shini Plastics Technologies, Inc.		Frequency	
Modified by		Modify date		SHINI		3/230V	
Before modification				SHINI		50/60HZ	
Mark				SHINI		Totally 10 Pages	
				SHINI		CE	
				SHINI		8	



1	2		3	4	5	6	7	8
NO.	Symbol	Name	Manufacturer	Type	Specification	Number	Material number	Remark
1	Q1	Main switch	MOELLER	T0-2-1/EA/SVB	16A	1	YE10021160000	
2	Q2	Circuit breakers	TECO	BM-63C	6A	1	YE40603000000	
3	S2 S3	Capacitive proximity switch	IFM	KI 5082	10~36VDC	2	YE15508200000	(1)
4	S7-S10	Capacitive proximity switch	IFM	KI 5082	10~36VDC	4	YE15508200000	(1) (2)
5	S5	Safety switch	SCHMERSRC	AZ152VK-1476	AC-15	1	YE16147600100	(1)
6	S6	Pressure switch	FOX	K4SA02	1~12KG	1	YE15401000000	(1)
7	K1	Contactors	SIEMENS	3RT6015-1AN21	230V 50/60Hz	1	YE00601521000	
8	K3	Phase sequence protector	CHAO SHI	ABJ-10W	230V	1	YE03103800000	
9	K2	Middle relay	WEIDMULLER	DRM270024LT	24VDC 12A	1	YE03272400000	
10	F1	Overload relays	SIEMENS	3RU6116-1DB0	2.3-3.2A	1	YE01160220000	
11	FU1	Fuse base	CHINT	RT18-32	2P	1	YE41032200000	B
12		Fuse	CHINT	10x38 500V	2A	2	YE46002000100	
13	U	DC power	MEAN WELL	S-100-24	+24V 4.5A	1	YE71102400000	
14	CPU,A1-A6	Controller	B&R	----	----	1	YE80024000100	
15	HMI	Human-machine interface	SCHNEIDER	GXU3512	24VDC	1	YE80351200100	
16	H1	Buzzer	SHINI	PK-27A	24VDC 50Hz	1	YE84002700000	
17	H2	Indicator	---	LTE-3051	24VDC 50Hz	1	YE83305100300	
18	BW1/BW2	Dose transducer	VISHAY	LPS	10VDC 2mV/V	2	----	(1)
19	X1	Terminal	Honeywell	SK2.5	2.5mm <sup>2</sup>	8	YE60002503200	
20			----	GK2.5PE	2.5mm <sup>2</sup> PE	4	YE60002503400	
21	X2	Terminal		SK2.5-TL	250V 2.5	7	YE60002503600	
22	X2	Terminal		SK2.5-TL	250V 2.5	1	YE60002503600	(2)
23	X3	Terminal		SK2.5-TL	250V 2.5	4	YE60002503600	
24	X3	Terminal		SK2.5-TL	250V 2.5	4	YE60002503600	(2)
25	X5	Terminal	----	2.5mm <sup>2</sup>	----	6	YE61250040000	
<b>整机版本 Ver.C</b> Note: (1) means not part of control box. (2)stands for optional								
				Version	A	Drawing NO.		Page 9
				Designer		SGB-1200-4-CE-230V-A-9		Totally 10 Pages
				Proofread by		Electrical Components List 1		CE
				Checked by		Voltage		3/230V
				Modified by		Frequency		50/60Hz
				Modify date	20170608			8
Mark	Before modification	After modification		Date	20170608	SHINI 信易塑料机械股份有限公司 Shini Plastics Technologies, Inc.		50/60Hz







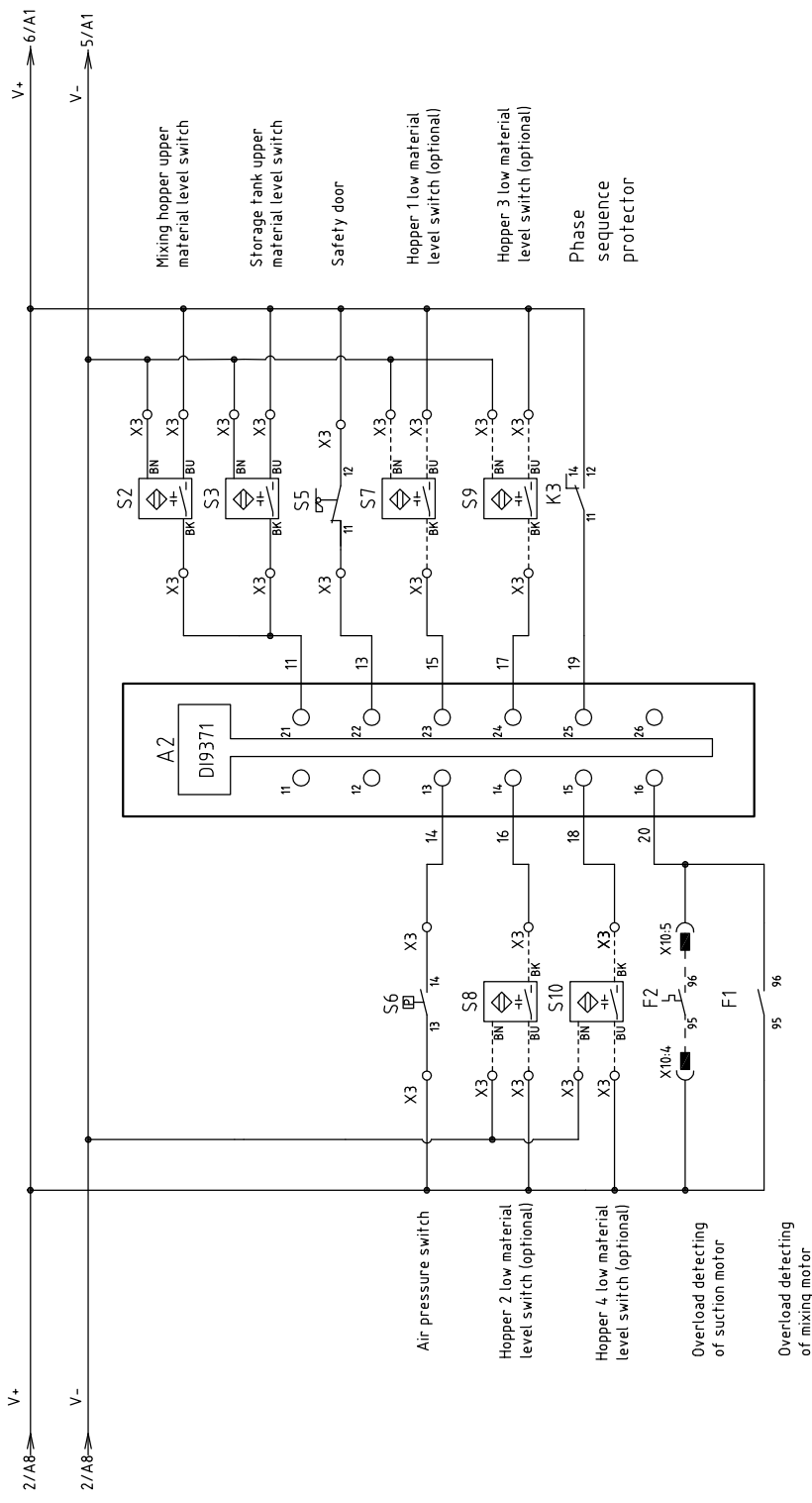

整机版本 Ver.B

1	2	3	4	5	6	7	8
Title			Version		Drawing No.		Page
SGB-2000/3000-4			C		SGB-2000/3000-4-CE-230V-C-3		3
Electrical Diagram 3			Approved by		Standard		Totally
Date			Checked by		CE		12
Date			Modify date		Voltage		3/230V
Date			Modify date		Frequency		50/60Hz
Date			Date		Frequency		50/60Hz
Date			Date		Frequency		50/60Hz



1 2 3 4 5 6 7 8

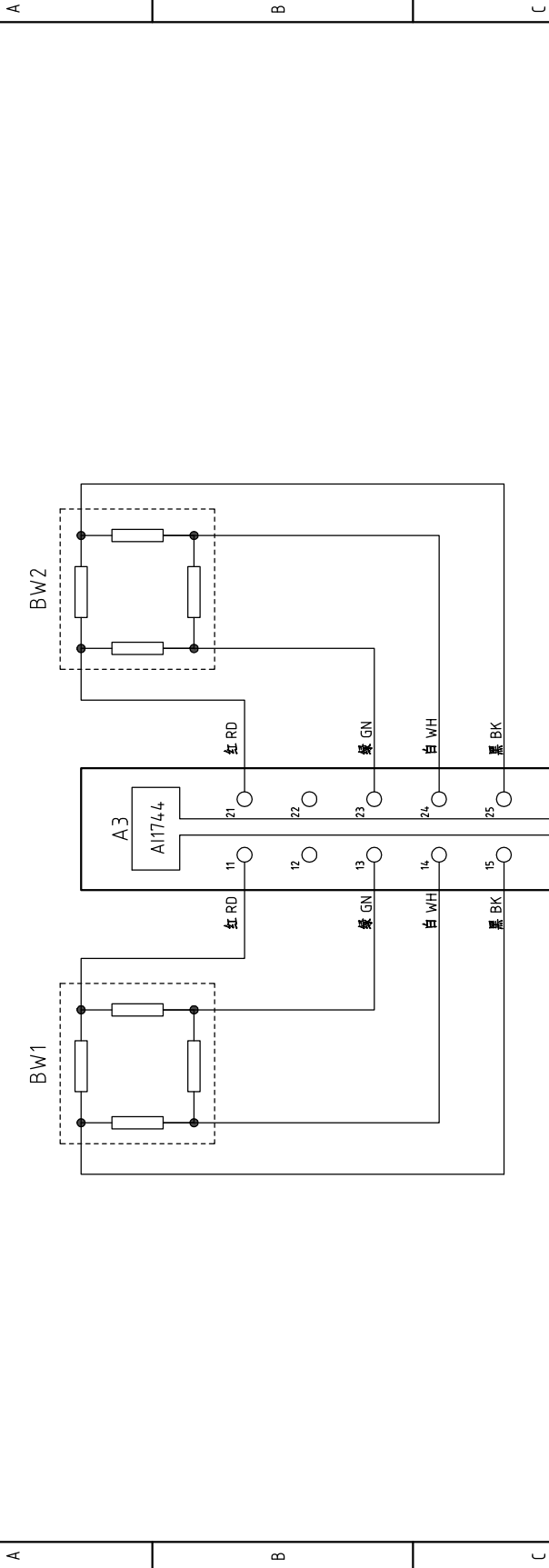

整机版本 Ver.B

Mark	Before modification	After modification	Modify date	Checked by	Proofoad by	Designer	Drawer	Version	C	Title	SGB-2000/3000-4 Electrical Diagram 4	Drawing NO.	SGB-2000/3000-4-CE-230V-C-4	Scale	Standard	CE	Page	4			
								Approved by										Totally	12		
								Date	20170608										Pages	3/230V	
																				Frequency	50/60HZ



1 2 3 4 5 6 7 8

3/A8 → V- 6/A1

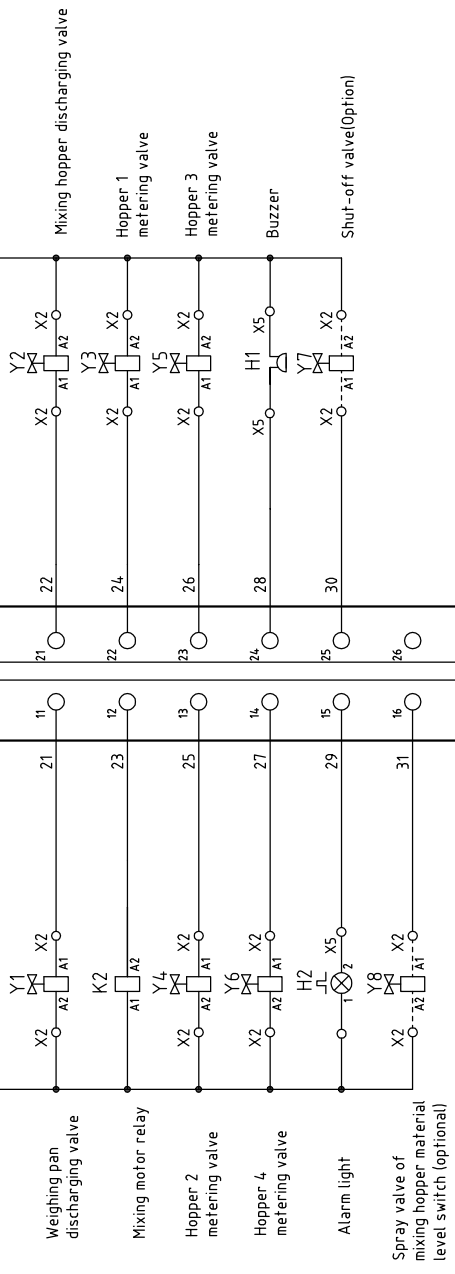
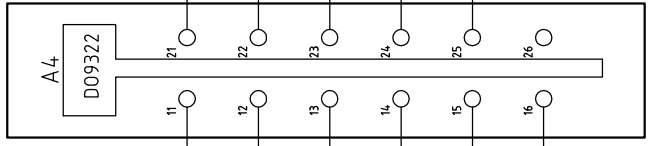

整机版本 Ver.B

Title		Version		Page	
SGB-2000/3000-4 Electrical Diagram 5		C		5	
Drawing NO.		Designer		Standard	
SGB-2000/3000-4-CE-230V-C-5		Proofread by		CE	
SHINI 信易塑料机械股份有限公司 Shini Plastics Technologies, Inc.		Checked by		Voltage	
20170608		Modify date		Frequency	
Date		Modified by		3/230V	
Date		After modification		50/60HZ	
20170608		Before modification		8	
20170608		Mark		8	

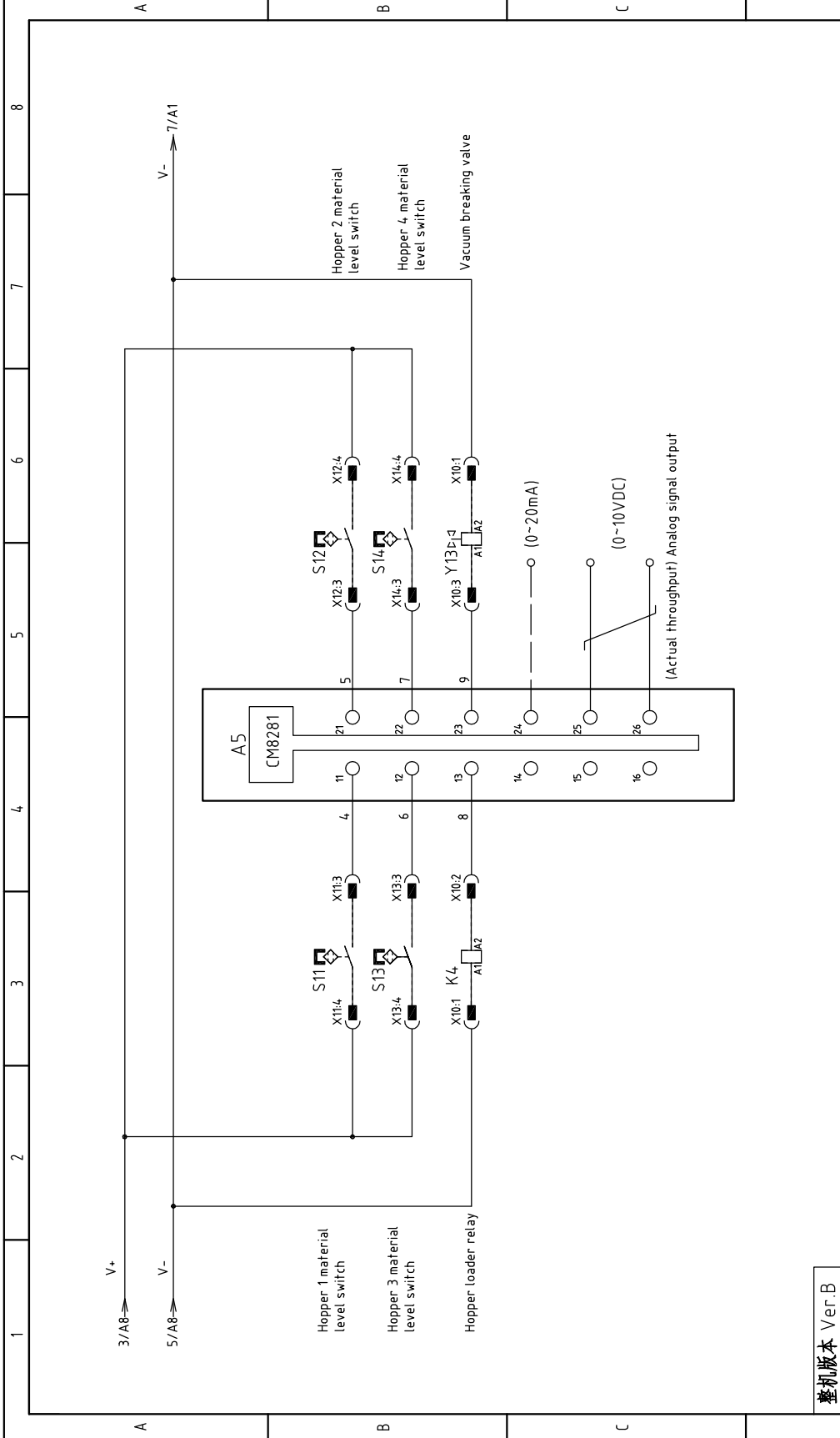

整机版本 Ver.B

Mark	Before modification	Modified by	20170608	Version	C	Title	SGB-2000/3000-4 Electrical Diagram 6		Drawing NO.	SGB-2000/3000-4-CE-230V-C-6		Scale	Page	6
Before modification	After modification	Modify date	Date	Designer	Approved by	SHINI 信易塑料机械股份有限公司 Shini Plastics Technologies, Inc.		Standard	CE	Totally	12	Standard	Voltage	3/230V
				Proofread by						Frequency	50/60Hz		Frequency	50/60Hz
				Checked by										



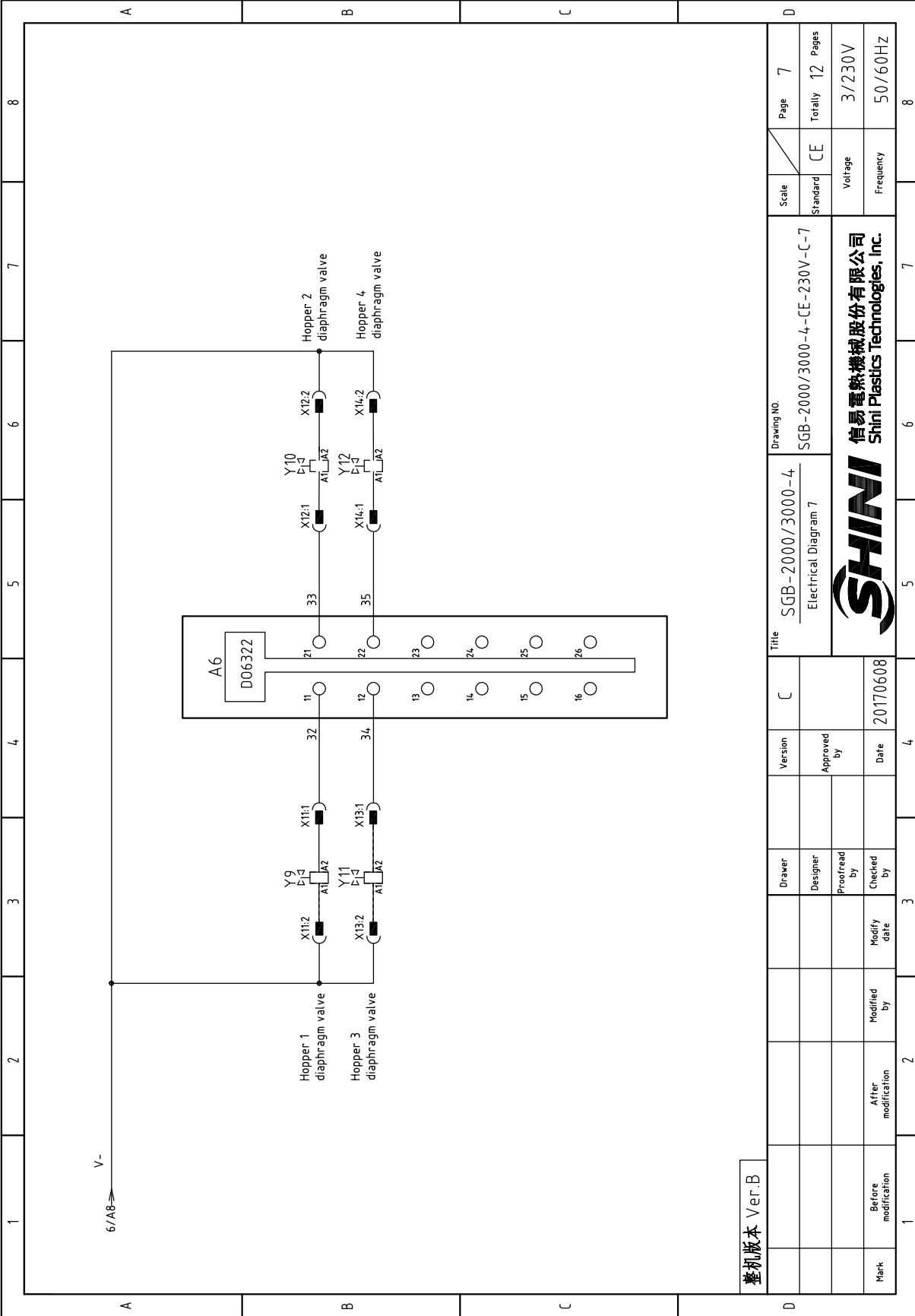

整机版本 Ver.B

Mark	Before modification	Modified by	Modify date	Checked by	Date	20170608
	After modification	Modified by	Modify date	Checked by	Date	
Designer	Designer	Proofread by	Proofread by	Approved by	Approved by	
Drawer	Drawer	Version	Version	C	C	
Title			SGB-2000/3000-4 Electrical Diagram 7			
Drawing NO.			SGB-2000/3000-4-CE-230V-C-7			
Scale	Standard	CE	Standard	CE	Page	7
Voltage	3/230V	Frequency	50/60HZ	Totally	12	Pages



1 2 3 4 5 6 7 8

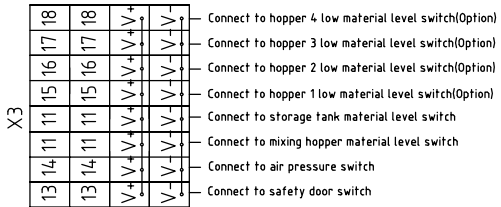
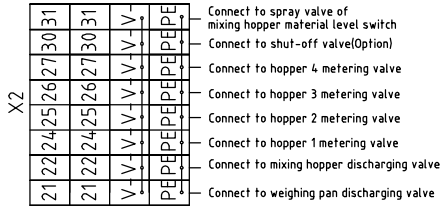
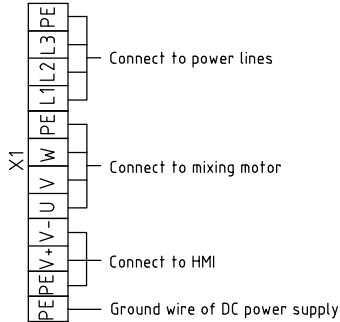
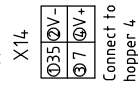
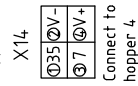
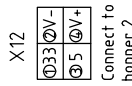
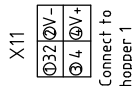
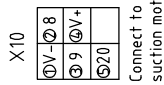
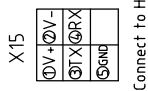
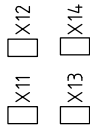
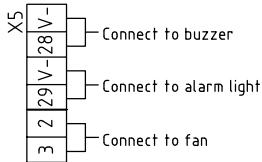
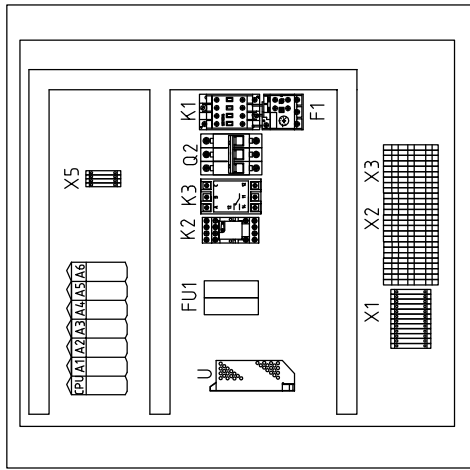

整机版本 Ver.B

Mark	Before modification	Modified by	Modify date	Checked by	Date	20170608	Version	C	Title	Drawing NO.	Page	8	
	After modification	Modified by	Modify date	Checked by	Date						Scale		Page
Electrical Components Layout										SGB-2000/3000-4-CE-230V-C-8		Totally	12
SHINI 信易塑料机械股份有限公司 Shini Plastics Technologies, Inc.										Standard	CE	Voltage	3/230V
										Frequency	50/60Hz		

1 2 3 4 5 6 7 8

1	2		3	4	5	6	7	8	
NO.	Symbol	Name	Manufacturer	Type	Specification	Number	Material number	Remark	
1	Q1	Main switch	MOELLER	T0-2-1/EA/SVB	16A	1	YE10021160000		
2	Q2	Circuit breakers	TECO	BM-63C	6A	1	YE40603000000		
3	S2 S3	Capacitive proximity switch	IFM	KI 5082	10~36VDC	2	YE15508200000	(1)	
4	S7-S10	Capacitive proximity switch	IFM	KI 5082	10~36VDC	4	YE15508200000	(1) (2)	
5	S5	Safety switch	SCHMERSRC	AZ152VK-1476	AC-15	1	YE16147600100	(1)	
6	S6	Pressure switch	FOX	K4SA02	1~12KG	1	YE15401000000	(1)	
7	K1	Contactors	SIEMENS	3RT6015-1AN21	230V 50/60Hz	1	YE00601521000		
8	K3	Phase sequence protector	CHAO SHI	ABJ-10W	230V	1	YE03103800000		
9	K2	Middle relay	WEIDMULLER	DRM270024LT	24VDC 12A	1	YE03272400000		
10	F1	Overload relays	SIEMENS	3RU6116-1DB0	2.3-3.2A	1	YE01160140000		
11	FU1	Fuse base	CHINT	RT18-32	2P	1	YE41032200000	B	
12		Fuse	CHINT	10x38 500V	2A	2	YE46002000100		
13	U	DC power	MEAN WELL	S-100-24	+24V 4.5A	1	YE71102400000		
14	CPU,A1-A6	Controller	B&R	----	----	1	YE80024000100		
15	HMI	Human-machine interface	SCHNEIDER	GXU3512	24VDC	1	YE80351200100		
16	H1	Buzzer	SHINI	PK-27A	24VDC 50Hz	1	YE84002700000		
17	H2	Indicator	---	LTE-3051	24VDC 50Hz	1	YE83305100300		
18	BW1/BW2	Dose transducer	VISHAY	LPS20KG	10VDC 2mV/V	2	----	(1)	
19	X1	Terminal	Honeywell	SK2.5	2.5mm <sup>2</sup>	8	YE60002503200		
20			----	GK2.5PE	2.5mm <sup>2</sup> PE	4	YE60002503400		
21	X2	Terminal		SK2.5-TL	250V 2.5	7	YE60002503600		
22	X2	Terminal		SK2.5-TL	250V 2.5	1	YE60002503600	(2)	
23	X3	Terminal		SK2.5-TL	250V 2.5	4	YE60002503600		
24	X3	Terminal		SK2.5-TL	250V 2.5	4	YE60002503600	(2)	
25	X5	Terminal	Honeywell	SK2.5	2.5mm <sup>2</sup>	6	YE60002503200		
整机版本 Ver.B		Note: (1) means not part of control box. (2)stands for optional							
D		Title		Drawing NO.		Scale		Page	
		SGB-2000-4		SGB-2000-4-CE-230V-C-9		CE		9	
		Electrical Components List 1				Voltage		3/230V	
						Frequency		50/60Hz	
Mark		Before modification		After modification		Modified by		Modify date	
		Designer		Proofread by		Checked by		Date	
		Version		Approved by		Date		20170608	
		C							
		D							
		SHINI		SHINI		SHINI		SHINI	
		信易塑料机械股份有限公司		Shini Plastics Technologies, Inc.					
		5		6		7		8	



1	2		3	4	5	6	7	8
NO.	Symbol	Name	Manufacturer	Type	Specification	Number	Material number	Remark
1	Q1	Main switch	MOELLER	T0-2-1/EA/SVB	16A	1	YE10021160000	
2	Q2	Circuit breakers	TECO	BM-63C	10A	1	YE40301003000	
3	S2 S3	Capacitive proximity switch	IFM	KI 5082	10~36VDC	2	YE15508200000	(1)
4	S7-S10	Capacitive proximity switch	IFM	KI 5082	10~36VDC	4	YE15508200000	(1) (2)
5	S5	Safety switch	SCHMERSRC	AZ152VK-1476	AC-15	1	YE16147600100	(1)
6	S6	Pressure switch	FOX	K4SA02	1~12KG	1	YE15401000000	(1)
7	K1	Contactors	SIEMENS	3RT6016-1AN21	230V 50/60Hz	1	YE00601621000	
8	K3	Phase sequence protector	CHAO SHI	ABJ-10W	230V	1	YE03103800000	
9	K2	Middle relay	WEIDMULLER	DRM270024LT	24VDC 12A	1	YE03272400000	
10	F1	Overload relays	SIEMENS	3RU6116-1GB0	4.5-6.32A	1	YE01160450000	
11	FU1	Fuse base	CHINT	RT18-32	2P	1	YE41032200000	B
12		Fuse	CHINT	10x38 500V	2A	2	YE46002000100	
13	U	DC power	MEAN WELL	S-100-24	+24V 4.5A	1	YE71102400000	
14	CPU,A1-A6	Controller	B&R	----	----	1	YE80024000100	
15	HMI	Human-machine interface	SCHNEIDER	GXU3512	24VDC	1	YE80351200100	
16	H1	Buzzer	SHINI	PK-27A	24VDC 50Hz	1	YE84002700000	
17	H2	Indicator	---	LTE-3051	24VDC 50Hz	1	YE83305100300	
18	BW1/BW2	Dose transducer	VISHAY	LPS50KG	10VDC 2mV/V	2	----	(1)
19	X1	Terminal	Honeywell	SK2.5	2.5mm <sup>2</sup>	8	YE60002503200	
20			----	GK2.5PE	2.5mm <sup>2</sup> PE	4	YE60002503400	
21	X2	Terminal		SK2.5-TL	250V 2.5	7	YE60002503600	
22	X2	Terminal		SK2.5-TL	250V 2.5	1	YE60002503600	(2)
23	X3	Terminal		SK2.5-TL	250V 2.5	4	YE60002503600	
24	X3	Terminal		SK2.5-TL	250V 2.5	4	YE60002503600	(2)
25	X5	Terminal	Honeywell	SK2.5	2.5mm <sup>2</sup>	6	YE60002503200	
整机版本 Ver.B Note: (1) means not part of control box. (2)stands for optional								
D				Title		Drawing NO.		Page
				SGB-3000-4		SGB-3000-4-CE-230V-C-11		11
				Electrical Components List 1		CE		12
						Voltage		3/230V
						Frequency		50/60Hz
								8



