

SIC-A

Air-cooled Water Chillers

Date: Mar., 2022

Version: Ver.C (English)



Contents

1. General Description	6
1.1 Coding Principle.....	7
1.2 Features.....	7
1.3 Technical Specifications	9
1.3.1 External Dimensions.....	9
1.3.2 Specification List.....	10
1.4 Safety Regulations.....	12
1.4.1 Security Labels.....	12
1.5 Exemption Clause.....	13
2. Structural Features and Working Principle.....	14
2.1 Main Functions.....	14
2.1.1 Working Principle.....	14
2.2 Main Components and Functions	16
2.2.1 Compressor.....	16
2.2.2 Condenser.....	16
2.2.3 Drying Filter	16
2.2.4 Thermal Expansion Valve.....	17
2.2.5 Evaporator.....	17
2.2.6 High and Low Pressure Controller.....	17
2.2.7 Fluid Reservoir	18
2.3 Options	19
2.3.1 Refrigerant Indicator.....	19
2.3.2 Liquid Pipe Solenoid Valve.....	19
2.3.3 Hot-gas By-pass Valve	19
2.3.4 Flow Switch	20
2.3.5 Liquid Level Indicator.....	20
2.4 Main Electrical Components	21
2.4.1 Thermal Overload Relay.....	21
3. Installation and Debugging.....	22
3.1 Installation Notices.....	22
3.2 Installation Diagram	24
3.3 Power Connection.....	24

4. Application and Operation	25
4.1 Panel Diagram	25
4.2 Common Screens	25
4.3 Quick Operation	26
4.4 Startup	27
4.5 Shutdown	27
4.6 User Menu	28
4.6.1 Parameter Operation	28
4.6.2 User Setting.....	28
4.6.3 Machine Set	29
4.6.4 System Time Set	29
5. Trouble-shooting	30
6. Repair and Maintenance	34
6.1 Filling the Refrigerant.....	36
6.2 Components Maintenance	37
6.2.1 Condenser.....	37
6.2.2 Evaporator.....	37
6.3 Maintenance Schedule	39
6.3.1 About the Machine.....	39
6.3.2 Check after Installation	39
6.3.3 Daily Checking	39
6.3.4 Weekly Checking.....	39
6.3.5 Montly Checking.....	39
6.3.6 Trimonthly Checking.....	40
6.3.7 Half-yearly Checking	40
6.3.8 Yearly Checking	40
6.3.9 3 year Checking	40

Table Index

Table 1-1: Specifications	9
Table 1-2: Specifications List (1)	10
Table 1-3: Specifications List (2)	11

Table 6-1: SIC-A Series Filling Quantity 36

Picture Index

Picture 1-1: Outline Dimensional Drawing 9

Picture 2-1: Working Principle Diagram 14

Picture 2-2: Compressor 16

Picture 2-3: Condenser 16

Picture 2-4: Drying Filter 17

Picture 2-5: Thermal Expansion Valve 17

Picture 2-6: Evaporator 17

Picture 2-7: High and Low Pressure Controller 18

Picture 2-8: Fluid Reservoir 18

Picture 2-9: Refrigerant Indicator 19

Picture 2-10: Liquid Pipe Solenoid Valve 19

Picture 2-11: Hot-gas By-pass Valve 19

Picture 2-12: Flow Switch 20

Picture 2-13: Liquid Level Indicator 20

Picture 2-14: Thermal Overload Relay 21

Picture 3-1: Machine Installation Location 24

Picture 6-1: Fill in the Refrigerant (1) 36

Picture 6-2: Fill in the Refrigerant (2) 36

Picture 6-3: Water Drainage Port 38

1. General Description



Please read through this operation manual before using and installation to avoid damage of the machine and personal injuries.

SIC-A series air-cooled chiller adopts single-stage vapour compressed circuit, with compressor overload protection, pump overload protection, phase reverse alarm, anti-freezing protection, high & low pressure protector, which features stable performance and long service life. It can quickly cool down, and maintain stable temperature to meet the requirements of customers. This series of products work following the heating and cooling exchange principle, which is an indispensable device for cooling applications in modern industry.



Model: SIC-7.5A

1.1 Coding Principle

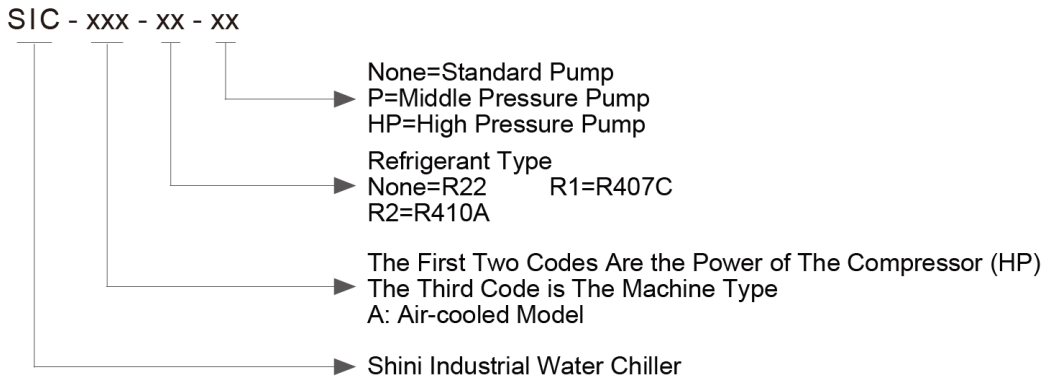

1.2 Features

Standard configuration

- Cooling range 7~25°C.
- Stainless steel insulated water tank and evaporator
- Anti-freezing protector
- Adopt R22 refrigerant, and cooling effect
- The refrigeration system adopts high and lower pressure controller for protection
- Low pressure pumps are standard configurations.
- Compressor and pump overload relays.
- Adopt Italian temperature controller that can maintain the accuracy of $\pm 0.1^\circ\text{C}$.
- All adopt branded compressors with low noise, high efficiency and long service life.
- SIC-A adopts fin style condenser design without any need of cooling water for excellent heat transfer and rapid cooling.

Accessory option

- Medium and high pressure pumps are optional to meet different water pressure requirements.
- Water tank level sensor is optional to check whether the water level is in normal condition.
- Hot-gas bypass valve is optional that can maintain the temperature control accuracy up to $\pm 1^\circ\text{C}$;
- The liquid pipe solenoid valve is optional to prevent evaporator freezing by cutting the refrigerant immediately after downtime.

- Level sensor can be opted to detect the refrigerant and ensure its quality and water ratio.
- Optional flow switches to detect chilled water flow.

All service work should be carried out by a person with technical training or corresponding professional experience. The manual contains instructions for both handling and servicing. Chapter 7, which contains service instructions intended for service engineers. Other chapters contain instructions for the daily operator.

Any modifications of the machine must be approved by SHINI in order to avoid personal injury and damage to machine. We shall not be liable for any damage caused by unauthorized change of the machine.

Our company provides excellent after-sales service. Should you have any problem during using the machine, please contact the company or the local vendor.

Shini Hotline Service:

Headquarter and Taipei factory:

Tel: + 886 (0)2 2680 9119

Shini Plastics Technologies (Dongguan), Inc.:

Tel: +86 (0)769 8331 3588

Shini Plastics Technologies (Pinghu), Inc.:

Tel: +86 (0)573 8522 5288

Shinden Precision Machinery (Chongqing), Inc.:

+86 (0)23 6431 0898

1.3 Technical Specifications

1.3.1 External Dimensions

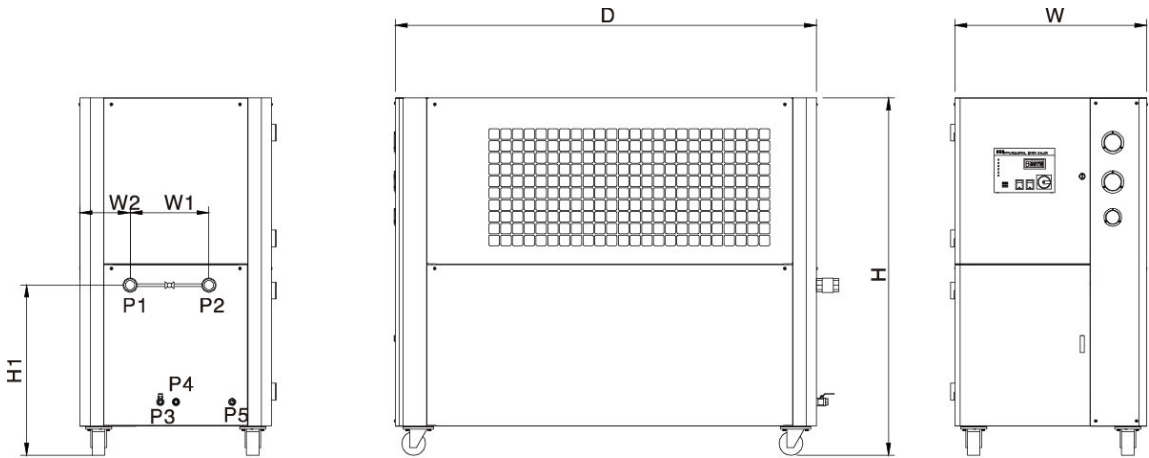

Picture 1-1: Outline Dimensional Drawing

Table 1-1: Specifications

Model	H (mm)	H1 (mm)	W (mm)	W1 (mm)	W2 (mm)	D (mm)	P1 (inch) Chilled Water Inlet	P2 (inch) Chilled Water Outlet	P3 (inch) Water Tank Outfall	P4 (inch) Water Tank Overfall	P5 (inch) Water Tank Refill Port	Weight (kg)
SIC-3A	1200	625	685	277	200	1190	1	1	1/2	1/2	1/2	260
SIC-5A	1400	640	735	360	174	1320	1	1	1/2	1/2	1/2	315
SIC-8A	1350	640	735	300	204	1610	1½	1½	1/2	1/2	1/2	400
SIC-10A	1440	640	735	300	204	1610	1½	1½	1/2	1/2	1/2	420
SIC-12.5A	1520	648	905	457	189	1780	2	2	1/2	1/2	1/2	520
SIC-15A	1520	648	905	457	189	1780	2	2	1/2	1/2	1/2	560
SIC-20A	1950	700	1200	450	150	2920	2	2	1	1/2	1/2	775
SIC-25A	1950	700	1200	450	150	2920	2	2	1	1/2	1/2	800
SIC-30A	1950	760	1200	430	160	2920	2½	2½	1	1/2	1/2	840
SIC-40A	1970	780	1300	450	200	3390	2½	2½	1	1	1	1400
SIC-45A	1970	780	1300	450	200	4230	2½	2½	1	1	1	1800
SIC-50A	1970	823	1420	700	360	4000	2½	2½	1	1	1	2000

1.3.2 Specification List

Table 1-2: Specifications List (1)

Item/ Parameters		Model		SIC-3A	SIC-5A	SIC-8A	SIC-10A	SIC-12.5A	SIC-15A	
Refrigerant Capacity ¹⁾	kW			7.35	12.5	19.5	26	30	38	
	Kcal/hr			6,321	10,750	16,770	22,360	25,800	32,680	
Compressor	Power(50Hz z/60Hz)	kW		2.55/	3.96/	6.11/	8.06/	9.11/	11.8/	
		HP		3	5	8	10	12.5	15	
Refrigerant	Weight (kg)			3.6	4.3	7	8	11	13	
	Control Mode		Thermostatic expansion valve							
	Type		R22							
Evaporator	Type		Tube-in-shell style							
Condenser	Type		Tube-fin style							
	Blower (kW) (50Hz/60Hz)			0.18	0.45	0.25×2	0.45×2	0.6×2	0.78×2	
Water Tank Capacity (L)				30		85		150		
Pump ²⁾ (50Hz)	Power (kW)			0.75/0.75/1.1		1.1		1.1/1.5/2.2		
	(L/Min) Pump Flow (L/min)			50/83/67		80/100/89		130/150/133		
	Working Pressure (kgf/cm ²)			2.0/2.6/3.8		2.0/2.6/3.5		2.0/3/4.2		
Total Power (kW) (50Hz/60Hz)(kW) ³⁾				3.48	5.16	7.71	10.06	11.41	14.81	
Pipe Coupling (inch)	Cooling Water Outlet			1		1 ¹ / ₂		2		
	Cooling Water Inlet			1		1 ¹ / ₂		2		
	Water Tank Outlet			1/2						
	Water Tank Port			1/2						
Protective Devices	Compressor		Overload relay							
	pump		Overload relay							
	Cooling Water Circuit		High and low pressure switch/anti-freeze switch							
	Water Circuit		Flow switch (optional) / water tank level sensor (optional) / bypass valve							
Power(VAC) ⁴⁾			3Φ,400V,AC 50HZ							
Measures Exchange			1Kw=860 kcal/hr 1RT=3,024kcal/hr 10,000Btu/hr=2,520kcal/hr							

We reserve the right to change specifications without prior notice.

Note:

- 1) Refrigeration capacity is measured based on the flow 0.172 m³ / (h.k W) and the outlet temperature (7°C) of chilled water under the environment temperature of 35°C.
- 2) Low pressure pump is for domestic and Southeast Asia export, customers can change for medium pressure pumps (use P for short; e.g.: SIC-5A-P) or high pressure pumps (use HP for short; e.g.: SIC-5A-HP), specific parameters in turn as shown above.
- 3) Pump power is included in total power.
- 4) Special orders of machine voltage can be acceptable according to customers' requests.

Table 1-3: Specifications List (2)

Item/ Parameters		Model						
		SIC-20A	SIC-25A	SIC-30A	SIC-40A	SIC-45A	SIC-50A	
Refrigerant Capacity ¹⁾¹	kW	52	60	76	104	114	120	
	Kcal/hr	44,720	51,600	65,360	87,720	98,040	103,200	
Compressor	output power (Hz)	kW	16.12	19.94	23.6	26.28	35.4	36.44
		HP	20	25	30	40	45	50
Refrigerant	Weight (kg)	18	22	26	34	42	48	
	Control Mode	Thermostatic expansion valve						
	Type	R22						
Evaporator	Type	Tube-in-shell style						
Condenser	Type	Tube-fin style						
	Blower power (kW)	0.8×2	1.1×2	1.5×2	1.1×3	1.5×3	1.5×4	
Water Tank Capacity (L)		180	200	270	400	650		
Water pump ²⁾ (50Hz)	Power (kW)	2.2/3/4		4/3/4		4/4/5.5		
	Pump flow (L/Min)	200/300/300		300/300/300		533/366/367		
	Pump pressure (kgf/cm ²)	2.5/3/4.2			2.7/3.4/4.3			
Total Power (kW) ³⁾		19.92	22.62	31.3	39.66	44.95	46.44	
Pipe	Cooling Water Outlet	2		2 ¹ / ₂		2 ¹ / ₂		
Coupling (inch)	Cooling Water Inlet	2		2 ¹ / ₂		2 ¹ / ₂		
	Water Tank Outlet	1						
	Water Tank Port	1/2			1			
Protective Devices	Compressor	Overload relay						
	pump	Overload relay						
	Cooling Water Circuit	High and low pressure switch/anti-freeze switch						
	Water Circuit	Flow switch (optional) / water tank level sensor (optional) / bypass valve						
Power(VAC) ⁴⁾		3Φ,400V,AC 50HZ						
Measures Exchange		Kw=860 kcal/hr 1RT=3,024kcal/hr 10,000Btu/hr=2,520kcal/hr						

We reserve the right to change specifications without prior notice.

Note:

- 1) Refrigeration capacity is measured based on the flow 0.172 m³ / (h.k W) and the outlet temperature (7°C) of chilled water under the environment temperature of 30°C.
- 2) Low pressure pump is for domestic and Southeast Asia export, customers can change for medium pressure pumps (use P for short; e.g.: SIC-5A-P) or high pressure pumps (use HP for short; e.g.: SIC-5A-HP), specific parameters in turn as shown above.
- 3) Pump power is included in total power.
- 4) Special orders of machine voltage can be acceptable according to customers' requests.

1.4 Safety Regulations

Operation should be carried out according to the safety regulations this manual to avoid damage of the machine and personal injuries.

Abide by the following regulations during operation.

1.4.1 Security Labels



Attention!

Installation of the device is allowed only to the professional electrician.
Before maintaining and repairing the device, be sure to turn off the main switch and control switch.



Warning!

High Voltage!

This label is posted on enclosure of the electrical control cabinet!



Warning!

Be careful!

Pay more attentions at the places where this sign is attached!



Attention!

Drain the water inside when power off at the cold day to avoid freezing!



Attention!

No need for regular inspection because all the electrical parts in the control unit are fixed tightly!

	<p>Please note the correct running direction. It indicates the pump running direction, please confirm. When the pump reverses, the alarm will sound and the control panel will display pump reverses. Please exchange any two power wires</p>
	<p>Pump pressure gauge: display actual pressure of the freezing water system.</p>
	<p>High pressure gauge: display the high pressure of the refrigerant system.</p>



Low pressure gauge: display the low pressure of the refrigerant system.

1.5 Exemption Clause

The following statements clarify the responsibilities and regulations born by any buyer or user who purchases products and accessories from Shini (including employees and agents).

Shini is exempted from liability for any costs, fees, claims and losses caused by reasons below:

1. Any careless or man-made installations, operation and maintenances upon machines without referring to the Manual prior to machine using.
2. Any incidents beyond human reasonable controls, which include man-made vicious or deliberate damages or abnormal power, and machine faults caused by irresistible natural disasters including fire, flood, storm and earthquake.
3. Any operational actions that are not authorized by Shini upon machine, including adding or replacing accessories, dismantling, delivering or repairing.
4. Employing consumables or oil media that are not appointed by Shini.

2. Structural Features and Working Principle

2.1 Main Functions

SIC-A air-cooled water chillers include consists of four main components, which are compressor, condenser, thermostatic expansion valve, and evaporator. The system adopts single-stage vapour compressed refrigeration system, which uses refrigerant gas-liquid conversion to absorb and release heat, thus achieving the cooling effect.

2.1.1 Working Principle

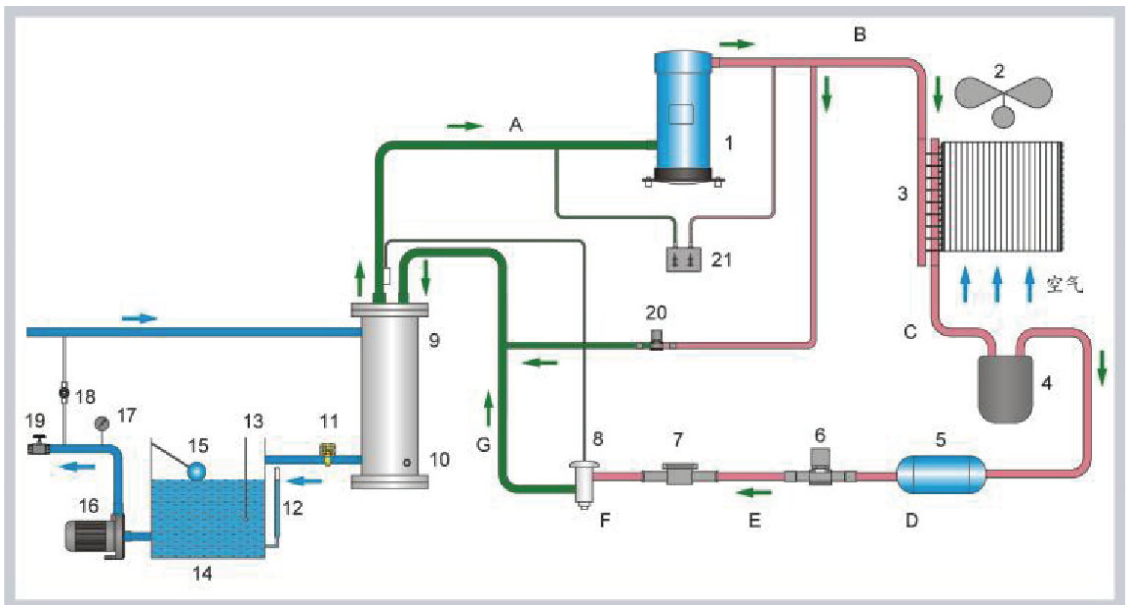

- | | | |
|--|--------------------------------------|---|
| 1.Compressor | 8.Expansion valve | 15.Float ball switch |
| 2.Fan | 9.Evaporator | 16.Pump |
| 3.Fin type condenser | 10.Anti-freezing switch | 17.Water-pre. Gauge |
| 4.Fluid Reservoir | 11.Flow switch(option) | 18.By-pass valve |
| 5.Drying filter | 12.Water tank liquid sensor (option) | 19.Sluice valve (for med. and high pressure pump) |
| 6. Liquid pipe solenoid valve (optional) | 13.Temp. sensor | 20.Hot-gas by pass valve(option) |
| 7. Refrigerant indicator (optional) | 14.Water tank | 21.Pressure controller |

Picture 2-1: Working Principle Diagram

When the machine is started, compressor (1) starts working. Refrigerant is compressed into high pressure and high temperature gas in the process from B to C to enter the condenser 3 to exchange heat with the air, which changes from gas to liquid and the heat is taken away by the air; In the C-D-E-F process, the liquid

refrigerant from the condenser flows through the fluid reservoir r4 to the filter 5 after drying, which finally reaches the expansion valve 8 via the liquid pipe solenoid valve 6 and refrigerant indicator 7 by drying and impurity filtering. In the F-G process, the temperature of high pressure liquid refrigerant decreases after thermal expansion valve throttling and depressurizing. In the G-A process, the low pressure and low temperature refrigerant exchanges heat with the chilled water through the evaporator 9, and the temperature of cooling the chilled water reach the set value; The low temperature gas refrigerant from the evaporator returns to the compressor, which circulates in this way.

Hot-gas bypass function: when the temperature of chilled water reaches the set temperature, the compressor continues to work. When the temperature drops to the set temperature of the hot gas bypass valve, the hot gas bypass valve opens. Part of the compressed high-temperature and high-pressure refrigerant directly reaches the evaporator through the hot gas bypass valve, which neutralizes some refrigerants and returns the compressor (without passing the condenser). The refrigeration system achieves the balanced load and cooling capacity through the hot-gas bypass valve, so that the compressor can work all the time while keeping chilled water temperature accuracy at $\pm 1^{\circ}\text{C}$.

2.2 Main Components and Functions

2.2.1 Compressor

- 1) It compresses and conveys the refrigerant vapor that results in low and middle of the evaporator, and middle and high pressure of the refrigerant, which is the core part of whole system.
- 2) Our company produces scroll and piston compressors.
- 3) The power of common compressors is 25%-30% cooling capacity of the water chiller.



Picture 2-2: Compressor

2.2.2 Condenser

- 1) It is the heat output device, which can discharge the heat absorbed by the refrigerant in the evaporator and the heat converted by the compressor consumption to the cooling medium.
- 2) Our company uses the air-cooled condenser (Tube-fin style).

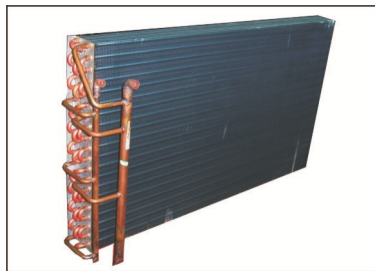

Picture 2-3: Condenser

2.2.3 Drying Filter

- 1) Drying filter function: Remove the impurities in the refrigerant, and absorb the free moisture in the refrigerant to prevent ice blocked in the narrow section of the pipeline (especially at the thermal expansion valve port).
- 2) The filter size is usually selected according to the refrigerant pipe diameter.

- 3) It is mounted in front of the thermal expansion valve to protect the valve's tightness

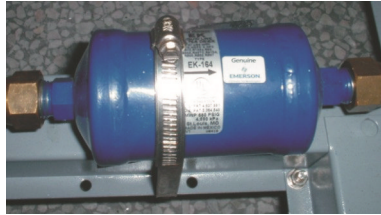

Picture 2-4: Drying Filter

2.2.4 Thermal Expansion Valve

- 1) The thermostatic expansion valve can throttle and depressurize the refrigerant and regulate the refrigerant flow into the evaporator.
- 2) The heat expansion valve is installed in front of the evaporator.



Picture 2-5: Thermal Expansion Valve

2.2.5 Evaporator

- 1) The evaporator is a device that outputs the refrigerant, which absorbs the heat of the cooled object in the evaporator, so as to achieve the refrigerating purpose.
- 2) Our company uses the horizontal shell and tube evaporator.

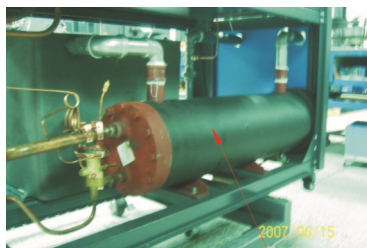

蒸发器

Picture 2-6: Evaporator

2.2.6 High and Low Pressure Controller

- 1) The high and low pressure controller is used to control the working pressure at the compressor air inlet and outlet.
- 2) The high-pressure controller is set to 25bar, and the low-pressure controller is set to 2bar.
- 3) It will give the alarm when the compressor outlet air pressure is higher than 25bar, or the compressor suction port is lower than 2bar,

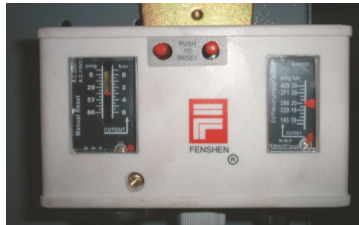

Picture 2-7: High and Low Pressure Controller

2.2.7 Fluid Reservoir

- 1) It is used to store the liquid refrigerants from the condenser to ensure that the heat transfer area of the condenser can play a full role.
- 2) The pipe installed between the condenser and drying filter.



Picture 2-8: Fluid Reservoir

2.3 Options

2.3.1 Refrigerant Indicator



Picture 2-9: Refrigerant Indicator

- 1) The refrigerant indicator is used to detect whether the refrigerant is filled appropriately.
- 2) The refrigerant indicator is used to detect the water ratio of the system.

2.3.2 Liquid Pipe Solenoid Valve



Picture 2-10: Liquid Pipe Solenoid Valve

Cut off the refrigerant supply circuit immediately after shutdown to prevent the evaporator from freezing.

2.3.3 Hot-gas By-pass Valve



Picture 2-11: Hot-gas By-pass Valve

It is used for bypass refrigerant gas at low temperature to avoid compressor frequent start-up for accurate temperature control.

2.3.4 Flow Switch



Picture 2-12: Flow Switch

The flow switch is adopted to avoid system damage caused by the cold water circulation failure of the water chiller.

2.3.5 Liquid Level Indicator

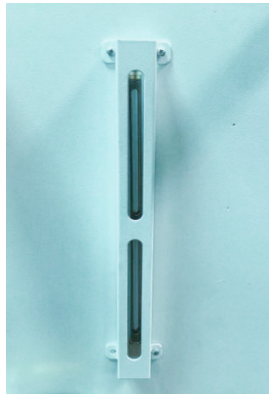

Picture 2-13: Liquid Level Indicator

With the liquid level indicator, it can check whether the water level in the tank is in normal range.

2.4 Main Electrical Components

2.4.1 Thermal Overload Relay

When delivers the machine, the thermal relay is set to the manual reset mode. So when the system indicates motor overload fault, please troubleshoot first. Then, it must open the door of the control box, and press the reset button of the thermal relay (If it can't be pressed, please wait about 1 min. and then press it again), so that the thermal relay can resume working.

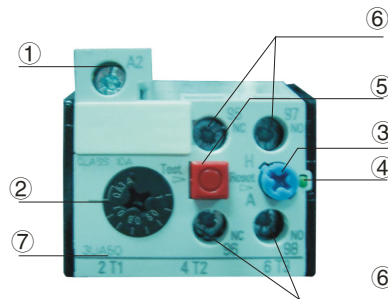

Picture 2-14: Thermal Overload Relay

The description of thermal overload relay:

- 1) Setting current adjusting scale
- 2) Reset button (blue)
H: Manual reset
A: Auto reset
- 3) Release indicator (green)
- 4) In case of manual reset, the indicator bar will be push-out after tripping, and there is no tripping indication in case of automatic reset.
- 5) Test button (red)
- 6) 95, 96, 97 and 98 are the wiring terminals of the auxiliary contacts, 95 and 96 are normally closed contacts and 97 and 98 are normally open contacts.
- 7) The terminal numbers of the main circuit must be consistent with that of the contactor.

3. Installation and Debugging



Attention !

Please read through this chapter carefully before installation, and install according to the following order!

The air-cooled water chiller needs a good cooling environment, so install the water chiller near the window with good air ventilation. If installing the water chiller in the workshop, the ambient temperature should not exceed 35°C. Besides, it should use the ventilator to make a good air circulation or use the ventilation pipe to discharge the hot air generated by the chiller to the room; If installing the water chiller outdoors, it must cover the top of the machine.

3.1 Installation Notices

- 1) Make sure that the voltage and frequency corresponds with the requirements on manufacturer's name plate.
- 2) Connection cable and ground wire must abide by local rules and regulations.
- 3) Use independent electrical wires and power switch, and the diameter of electrical wire should not be smaller than that of the electric wire used in control box.
- 4) Wiring connections should be firmly fixed.
- 5) The power of this series of water chiller is three phase five wire, the power supply is connected to the power live wire, (N) is connected to the null wire and (G) is connected to the earth wire.
- 6) Power supply:
- 7) Main power voltage and nameplate specified voltage: $\pm 5\%$
- 8) Main power frequency and nameplate specified voltage: $\pm 2\%$
- 9) Install the pipe system according to the installation configuration diagram, and use thermal insulation materials to preserve the heat of the cold water pipe.
- 10) The diameter of the circulating pump pipe shall not be smaller than that of the condenser pipe (The inlet and outlet piping system shall be installed

according to the assembly drawing). Large diameter water pipe shall be used to connect cooling water during long distance transmission.

- 11) The water discharge valve must be installed at the lowest part of the chilled water circulation system.
- 12) When the water source quality is poor, and the ambient environment of the cooling tower is harsh, the cooling water and chilled water loop must be equipped with the filters and cleaned regularly.
- 13) The circulating circuit of chilled water shall be covered with insulation layer to avoid the loss of cooling capacity and pipeline dripping.



The power wire connection of the water chiller must be done by the professional electrician! The circuit of the water chiller is not allowed to be modified without the consent of the company. If it is changed, our company is not liable for the machine damage.

3.2 Installation Diagram

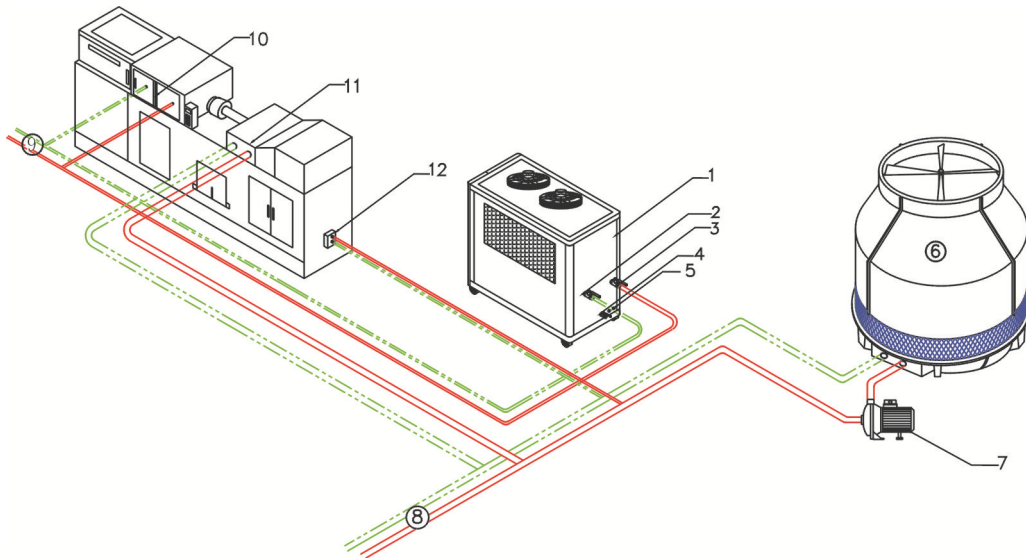

Parts Name :

- | | | |
|-------------------------|------------------------------|------------------------------|
| 1. Water chiller | 5. Water refill port | 9. Chilled water circulation |
| 2. Chilled water inlet | 6. Chilled water tower | 10. Mould Cooling |
| 3. Chilled water outlet | 7. Cooling water pump | 11. Cooling tank |
| 4. Drain port | 8. Cooling water circulation | 12. Oil Cooling |

Picture 3-1: Machine Installation Location

3.3 Power Connection

The SIC-A series must be connected with the power of 3Φ 400V 50Hz and earth wire.



Attention!

Before power connection, please make sure that the main power switch is turned off!

4. Application and Operation

4.1 Panel Diagram

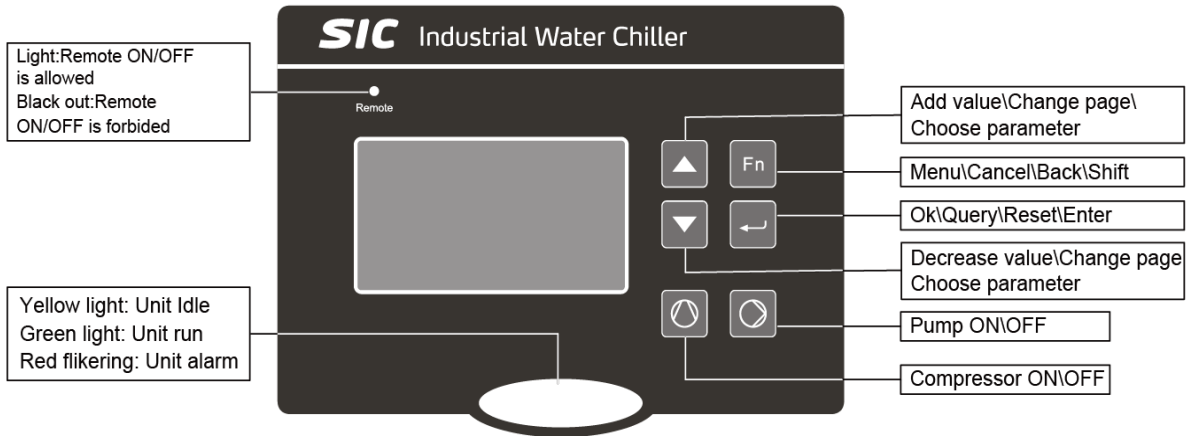

4.2 Common Screens

Commonly used screens include the main screen and the alarm screen.

1. Main Screen

The system will enter the main screen after countdown, which displays as follows:



2. Alarm Screen

In case of unit failure, the alarm screen is as follows:

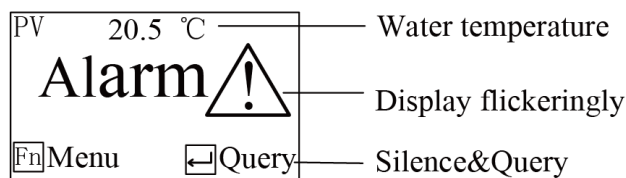

4.3 Quick Operation

1. Changing and Setting Temperature

If the user parameter [Lock Temp.] is set to "No", the setting temperature can be modified directly in the main screen, with operation details as follows:

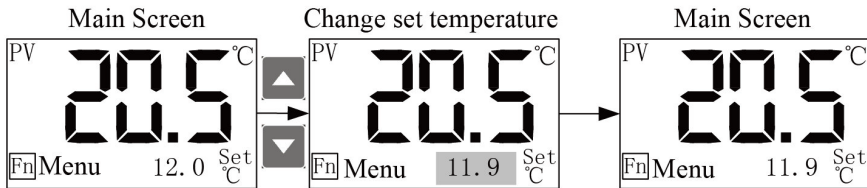

Note: the setting temperature can also be modified in the user parameters.

2. Query/Reset Fault

In case of fault, the alarm screen will automatically pop up. The operation details of query and reset faults are as follows:

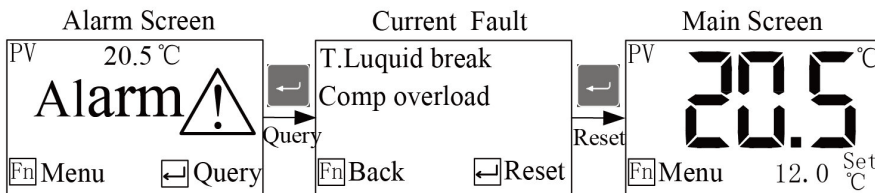

Attention!

Pump rotating direction should be correct.



Attention!

Before starting the system, make sure that cooling water pump is turned on. Check the water tank of the chiller. Do not start the machine when there is no water left in water tank. We shall not be liable for any damages caused by this reason.



Attention!



In order to reduce the possibilities of machine damage and prolong the life, start the machine with correct methods.



Attention!

The compressor can't be started frequently because of its characteristics (Frequent start will shorten its service life.). If emergency shut-down happens, the compressor will run again 3 minutes later.

4.4 Startup

- 1) Open the main power switch.
- 2) Set the temperature of chilling water (if the temp. has already been set, omit this step). The minimum temperature of this series machine should be set as 7°C.
- 3) Press  button to start the water pump.
- 4) Press  button to start the compressor.

4.5 Shutdown

- 1) Turn off the switch of compressor.
- 2) Turn off the pump switch. If it adopts the quick molding cycle and low cooling water temperature, keep continuous running of water pump till the mould temperature rises to non-condensated temperature, then turn off the pump switch.
- 3) Switch the main power switch to OFF position.



Attention!

When main power switch is at ON position, please be careful the electric shock!



Attention!

As to reduce the machine damage and prolong its service life, please turn off the machine in correct orders.

4.6 User Menu

Press the button  on the main screen to enter the User Menu, which includes five items as the table below:

No.	Menu Item	Funtion	Remark
1	User Setting	To set the user parameters	-
2	Unit Status	To display the current operating status of the unit	--
3	Fault Record	Allowing the query of the last 10 faults	Press  for 2s to clear the fault history.
4	Machine Set	To set language, backlight, time and so on.	--
5	Temp Query	To query all the temperature value	It is not display these item If measure the water temperature only.

4.6.1 Parameter Operation

For the modification operation of parameter value, the user's modification of setting temperature will be described as an example.

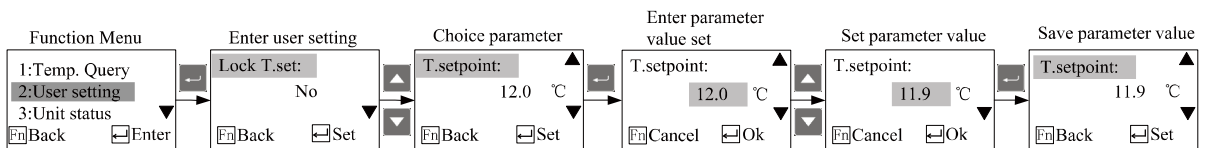

4.6.2 User Setting

All the parameters in user settings please refer to following table:

No.	Parameter Name	Factory Default	Setting Range	Remark
1	Lock Temp.	No	Yes ~ No	Yes: the [Set Temp.] can not be modified on the main screen when locked. No: the [Set Temp.] can be modified on the main screen.
2	Set Temp.	20.0°C	7.0~25°C	Setting range is limited by the manufacturer parameters [max. Temp.], [min. Temp.].
3	On/Off Mode	Local	Local / Local + Remote / Remote	Local: the unit can only start and stop locally. Local + Remote: the start and stop of the unit can be controlled both locally and remotely. Remote: the unit can only start and stop remotely.

4.6.3 Machine Set

The machine set includes six items as the table below:

No.	Item	Function	Remark
1	Language	To set the display language.	Chinese and English
2	Backlight Time	Setting range: 0~255min	0: backlight is not turned off.
3	Compr Use Time	To query the cumulative operation time of the compressor	
4	Comm. Setting	To set baud rate, parity bit, stop bit and communication address.	Communication protocol: Modbus RTU
5	Machine Info.	To query the machine version information.	
6	Clock setting	To query and set the system time.	

4.6.4 System Time Set

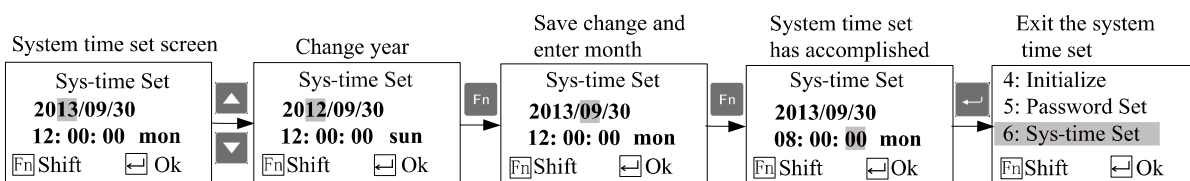

Note: Press the button  can exit the system time set quickly, and the set value will be saved when exit.

5. Trouble-shooting

Table 5-1: Single Compressor

Fault	Test Conditions	Troubleshooting	Solution
Compressor pressure High	Test when the compressor button has pressed	Stop compressor only without affect other equipments to work.	Check if the input is consistent with the switch setting.
Compressor pressure Low	If the [LP Check Delay] is 0, test when the compressor button has pressed;If the [LP Check Delay] is not 0, then compressor runs the test.		
Compressor Overload	Compressor runs the test		
Water Temp. Low	Test after pump starts	Stop the compressor, and do not stop the pump.	Check if the water temperature is lower than the set temperature of Liquid protection.
Water Temp. High		Stop the compressor, and do not stop the pump.	Check if the water temperature is higher than the set temperature of Liquid protection.
Anti-freeze Err	Power on to test	Stop the compressor, and do not stop the pump.	Check if the antifreeze input is consistent with the switch setting.
Water-temp. Sensor breaks			Check if the temperature probe is in proper contact.
Water-temp. Sensor short circuit			
Anti-freeze Sensor breaks			
Anti-freeze Sensor short circuit			
Anti-freeze Temp Low			Check if the antifreeze temperature is lower than the set temperature of antifreeze protection.
Blower fault (Only applicable for air-cooled series)	Compressor 1 runs the test	Stop the compressor, and do not stop the pump.	Check if the input is consistent with the switch setting.
Water Flow Short	Test after the pump starts for [Pump on Delay] time	Stop the unit	Check if the water flow input is consistent with the switch setting.
Pump Overload	Test after pump starts	Stop the unit	Check if the pump overload input is consistent with the switch setting.
Phase Err	Power on to test	Stop the unit	Check if there is default phase or anti-phase in the three-phase power input and if the switch is correct.
Water Level Low	Power on to test	Stop the unit	Check if the water level input is consistent with the switch setting.
Need Maintenance	Test after pump starts	The unit cannot start once stops (the accumulative operation time of compressor exceeds the set value).	Need Maintenance

Table 5-2: Double Compressor

Fault	Test Conditions	Troubleshooting	Solution
Compressor 1 pressure high	Test when the compressor button has pressed	Stop compressor 1 only without affect other equipments to work.	Check if the input is consistent with the switch setting.
Compressor 1 pressure low	If the [LP Check Delay] is 0, test when the compressor button has pressed;If the [LP Check Delay] is not 0, then compressor 1 runs the test.		
Compressor 1 overload	Compressor 1 runs the test		
Compressor 2 pressure high	Test when the compressor button has pressed	Stop compressor 2 only without affect other equipments to work.	Check if the input is consistent with the switch setting.
Compressor 2 pressure low	If the [LP Check Delay] is 0, test when the compressor button has pressed;If the [LP Check Delay] is not 0, then compressor 2 runs the test.		
Compressor 2 overload	Compressor 2 runs the test		
Water Temp. Low	Runs test	Stop the compressor, and do not stop the pump.	Check if the water temperature is lower than the set temperature of Liquid protection.
Water Temp. High		Stop the compressor, and do not stop the pump.	Check if the water temperature is higher than the set temperature of Liquid protection.
Anti-freeze Err	Power on to test	Stop the compressor, and do not stop the pump.	Check if the antifreeze input is consistent with the switch setting.
Water-temp. Sensor breaks			Check if the temperature probe is in proper contact.
Water-temp. Sensor short circuit			
Anti-freeze Sensor breaks			
Anti-freeze Sensor short circuit			
Anti-freeze temperature is too low		Stop the compressor, and do not stop the pump.	Check if the antifreeze temperature is lower than the set temperature of antifreeze protection
Blower 1 fault (Only applicable for air-cooled series)	Compressor 1 runs the test	Stop the compressor, and do not stop the pump.	Check if the blower 1 fault input is consistent with the switch setting.
Blower 2 fault (Only applicable for air-cooled series)	Compressor 2 runs the test		Check if the blower 2 fault input is consistent with the switch setting.
Water flow short	Test after the pump starts for (Pump on delay)time	Stop the unit	Check if the water flow input is consistent with the switch setting
Pump Overload	Test after pump starts	Stop the unit	Check if the pump overload input is consistent with the switch setting.
Phase Err	Power on to test	Stop the unit	Check if there is default phase or anti-phase in the three-phase power input and if the switch is correct.
Water Level Low	Power on to test	Stop the unit	Check if the water level input is consistent with the switch setting.
Need Maintenance	Test after pump starts	The unit cannot start once stops(the accumulative operation time of compressor exceeds the set value)	

Table 5-3: Triple, Quadruple Compressor

Fault	Test Conditions	Troubleshooting	Solution
Compressor 1 pressure high	Test when the compressor button has pressed	Stop compressor 1 only without affect other equipments to work.	Check if the input is consistent with the switch setting.
Compressor 1 pressure low	If the [LP Check Delay] is 0, test when the compressor button has pressed; If the [LP Check Delay] is not 0, then compressor 1 runs the test.		
Compressor 1 overload	Compressor 1 runs the test		
Compressor 2 pressure high	Test when the compressor button has pressed	Stop compressor 2 only without affect other equipments to work.	Check if the input is consistent with the switch setting.
Compressor 2 pressure low	If the [LP Check Delay] is 0, test when the compressor button has pressed; If the [LP Check Delay] is not 0, then compressor 2 runs the test.		
Compressor 2 overload	Compressor 2 runs the test		
Compressor 3 pressure high	Test when the compressor button has pressed	Stop compressor 3 only without affect other equipments to work.	Check if the input is consistent with the switch setting.
Compressor 3 pressure low	If the [LP Check Delay] is 0, test when the compressor button has pressed; If the [LP Check Delay] is not 0, then compressor 3 runs the test.		
Compressor 3 overload	Compressor 3 runs the test		
Compressor 4 pressure high	Test when the compressor button has pressed	Stop compressor 4 only without affect other equipments to work.	Check if the input is consistent with the switch setting.
Compressor 4 pressure low	If the [LP Check Delay] is 0, test when the compressor button has pressed; If the [LP Check Delay] is not 0, then compressor 4 runs the test.		
Compressor 4 overload	Compressor 4 runs the test		
Water Temp. Low	Test after pump starts	Stop the compressor, and do not stop the pump.	Check if the water temperature is lower than the set temperature of Liquid protection.
Water Temp. High		Stop the compressor, and do not stop the pump.	Check if the water temperature is higher than the set temperature of Liquid protection.
Anti-freeze Err	Power on to test	Stop the compressor, and do not stop the pump.	Check if the antifreeze input is consistent with the switch setting.
Water-temp. Sensor breaks			Check if the temperature probe is in proper contact.
Water-temp. Sensor short circuit			
Anti-freeze Sensor breaks			
Anti-freeze Sensor short circuit			
Anti-freeze temperature is too low		Stop the compressor, and do not stop the pump.	Check if the antifreeze temperature is lower than the set temperature of antifreeze protection

Fault	Test Conditions	Troubleshooting	Solution
Blower 1 fault (Only applicable for air-cooled series)	Compressor 1 runs the test	Stop the compressor, and do not stop the pump.	Check if the blower 1 fault input is consistent with the switch setting.
Blower 2 fault (Only applicable for air-cooled series)	Compressor 2 runs the test		Check if the blower 2 fault input is consistent with the switch setting.
Blower 3 fault (Only applicable for air-cooled series)	Compressor 3 runs the test		Check if the blower 3 fault input is consistent with the switch setting.
Blower 4 fault (Only applicable for air-cooled series)	Compressor 4 runs the test		Check if the blower 4 fault input is consistent with the switch setting.
Water flow short	Test after the pump starts for (Pump on delay)time	Stop the unit	Check if the water flow input is consistent with the switch setting
Pump Overload	Test after pump starts	Stop the unit	Check if the pump overload input is consistent with the switch setting.
Phase Err	Power on to test	Stop the unit	Check if there is default phase or anti-phase in the three-phase power input and if the switch is correct.
Water Level Low	Power on to test	Stop the unit	Check if the water level input is consistent with the switch setting.
Need Maintenance	Test after pump starts	The unit cannot start once stops(the accumulative operation time of compressor exceeds the set value)	

6. Repair and Maintenance

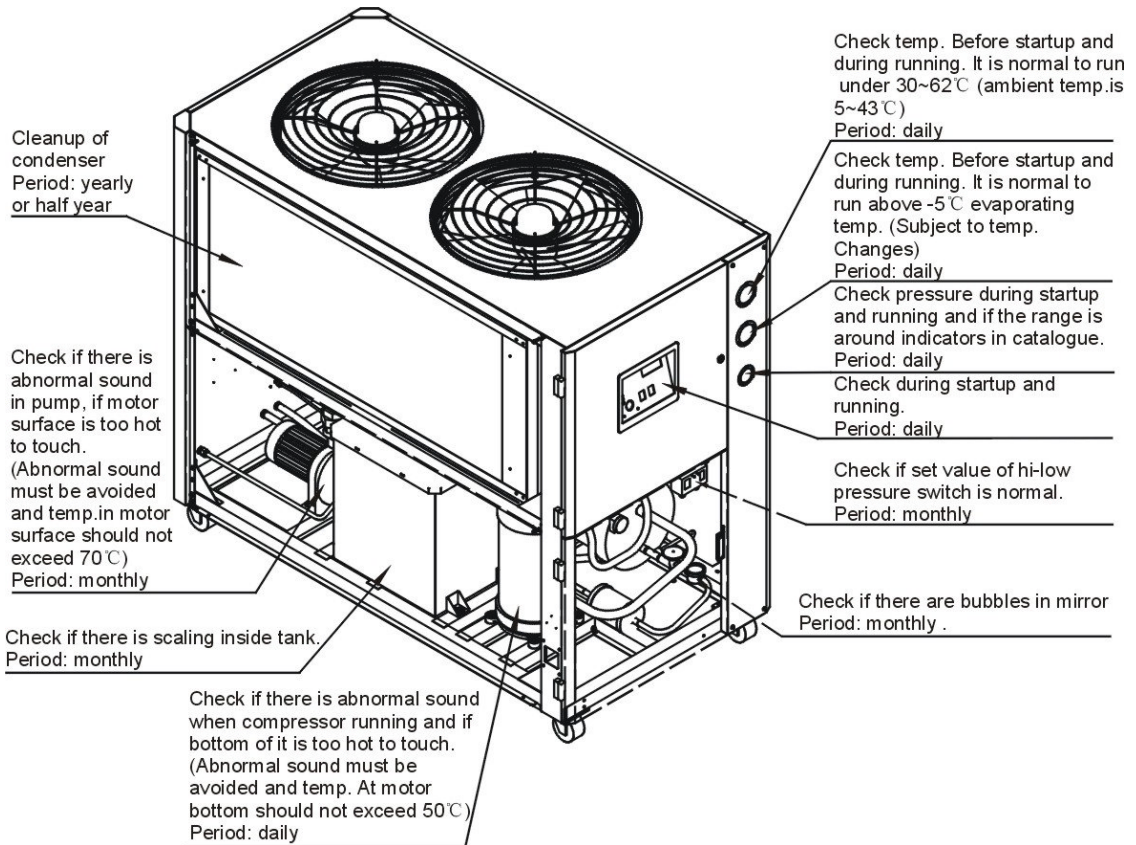



Attention!

All repair work should be done by qualified personnel only to avoid damage to the machine or personnel injury.

In order to operate the machine rightly and safely, please caution the matter follows:

- 1) Don't turn off the main power switch to stop the machine, except emergency situation.
- 2) When the machine shuts down, first press down the main power switch of the machine (the alarm light will be off); Then, check the cause of the fault again, and don't start the machine forcibly before troubleshooting.
- 3) Please check periodically to prolong the machine's service life and prevent the safety accident.
- 4) The water used in the system must have water treatment, because the high alkaline water will accelerate the corrosion of the copper pipe, and reduce the service life of the heat exchanger. The PH value of water is in the range of 7.0-8.5.
- 5) Keep the machine room dry, clean and well ventilated.
- 6) The operation and service of the machine should be done by qualified technician only (Please take notice that the disassembly and the inspection of the machines are hazardous when the machines are running!)

6.1 Filling the Refrigerant

- 1) Unscrew the cover of the liquid thimble valve, and connect the air pipe of the vacuum pump to the liquid thimble valve to vacuumize, which takes about 1 to 2 hours.

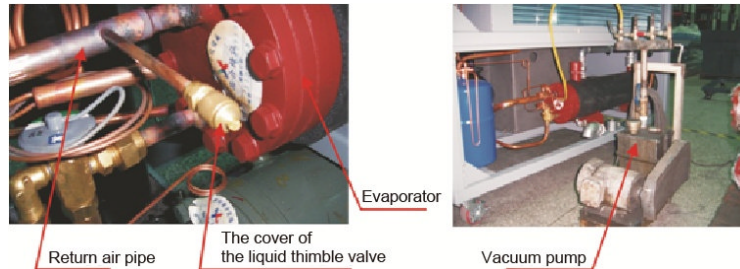

Picture 6-1: Fill in the Refrigerant (1)

- 2) After vacuumizing, connect the air pipe of the refrigerant tank to the liquid thimble valve, and add the refrigerant to the return air pipe. Monitor the weight change of the electronic scale, and stop filling the refrigerant when it reaches the rated filling weight.

When the machine is powered on, the display pressure of the high-pressure gauge is about: 13~15bar; and the display pressure of the low-pressure gauge is about: 3~5bar (Note: the ambient temperature is 30 °C, and the ice water temperature is about 12 °C).

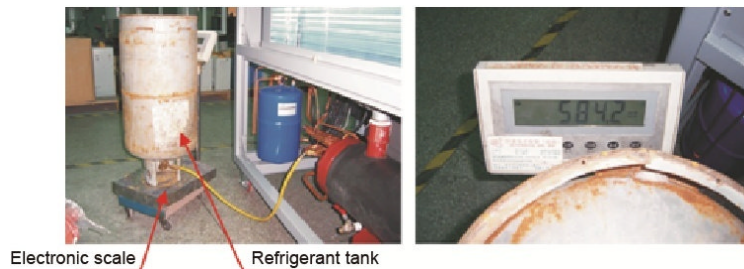

Picture 6-2: Fill in the Refrigerant (2)

Table 6-1: SIC-A Series Filling Quantity

Model	Refrigerant (kg)	Model	Refrigerant (kg)
SIC-3A	4.0	SIC-20A	18
SIC-5A	4.5	SIC-25A	20
SIC-8A	7.0	SIC-30A	26
SIC-10A	9.0	SIC-40A	34
SIC-12.5A	10	SIC-45A	42
SIC-15A	13	SIC-50A	48



Attention!

1. Don't replace with other refrigerant without permission.
2. Don't replace the components of the refrigerating system unauthorized.
3. The medium used is water. If you need to use other media, please consult the manufacturer in advance.

6.2 Components Maintenance

6.2.1 Condenser

The air-cooled tube-fin style condenser of the SIC-A series is installed in an open way. In the use process, it will inevitably adhere to dust and sundries, which reduces the heat exchange rate. The condenser should be cleaned regularly so that the machine can run stably. Use a brush, dust collector or compressed air to clean the dust and sundries on the condenser fins and copper pipe, and then use low-pressure water to spray the coil from the top to bottom or from inside to outside. Be careful not to sprinkle water on the fan motor.



Attention!

Do the cleaning work every half-year in the environment with little dust, but you must do the work every month in the environment with a great deal of dusts, and under the severe environment you had better see the situation to do the work.

6.2.2 Evaporator

The inner flank of the heat emission pipe will pile up a great deal of water scale after a long time use of the evaporator, which will influence the heat emission effect, so it is necessary to clean the evaporator at fixed periods in order to keep its working performance. If the circulation has been under water treatment, it is advised that firstly use hydrogen peroxide to kill bacteria and then use a high pressure water rifle to flush it, at last check whether there is still scale. If the circulation is not processed under water treatment, clean it with citric acid and sulfamic acid along with inhibitor, and then flush it with a high pressure water rifle. Passivation is need after acid washing, and the dirt will be discharged from the water outfall.



Attention!

Drain the water inside the evaporator and the condenser away when the machine stop running under 0°C . If the evaporator freezes, drain the water in it before restarting.



Water Drainage Port

Picture 6-3: Water Drainage Port

6.3 Maintenance Schedule

6.3.1 About the Machine

Model _____ SN _____ Production date _____

Voltage _____ Φ _____ V Frequency _____ Hz

Total power _____ kW

6.3.2 Check after Installation

- Check the pipes are all correctly connected.
- Check if there are leakages in the piping system.
- Check if there are breaks in welding joint.

Electrical Installation

- Voltage: _____ V _____ Hz
- Fuse specification: 1 Phase _____ A 3 Phase _____ A
- Check phase sequence of power supply.

6.3.3 Daily Checking

- Check switch functions.
- Check all the electrical wires.
- Check whether pressure gauges are accurate.
- Check whether compressor temperature is normal.
- Check whether cooling water circulation is normal.

6.3.4 Weekly Checking

- Check electrical connections.
- Check protection & alarm function of the water chiller.
- Check whether set point of high-low pressure switch is normal.

6.3.5 Montly Checking

- Check the refrigerant circulation pipe.
- Check whether there are bubbles in liquid indicator.
- Check whether there is abnormal sound in pump.

- Check whether there is scale formation in tank.

6.3.6 Trimonthly Checking

- Check whether condenser is under blockage.

6.3.7 Half-yearly Checking

- Check and clean the condenser and evaporator.
- Check and clean the filter and expansion valve.
- Check system performance.
- Clean condenser.

6.3.8 Yearly Checking

- Check whether the contactor is normal.

6.3.9 3 year Checking

- PC board renewal.
- No fuse breaker renewal.