

# **SICC-A Series**

## **Air-cooled Central Water Chiller**

Date: Aug, 2017

Version: Ver.B (English)





## Contents

<b>1. General Description .....</b>	<b>7</b>
1.1 Coding Principle .....	8
1.2 Feature .....	8
1.3 Technical Specifications .....	10
1.3.1 SICCC-A Series Outline Dimensions .....	10
1.3.2 The Illustrative Drawing of SICCC-A Modules Grouping .....	11
1.3.3 Specification .....	12
1.4 Safety Regulations .....	13
1.4.1 Notice Items for Safe Operation .....	13
1.4.2 Safety Signs and Labels .....	14
1.4.3 Signs and Labels .....	14
1.5 Exemption Clause .....	15
<b>2. Structure Characteristics and Working Principle .....</b>	<b>16</b>
2.1 Working Principle .....	16
<b>3. Installation and Debugging .....</b>	<b>17</b>
3.1 Installation Notice Items .....	17
3.2 Select Installation Site .....	17
3.2.1 Bearing Platform .....	18
3.2.2 Hanging and Transporting of the Unit .....	19
3.3 Combined Installation of Modules .....	20
3.4 Water System Tubing .....	21
3.5 Essentials for Electric Wiring .....	23
3.6 Communication Connection .....	24
3.6.1 Setting the Controller Address of the Host Machine .....	24
3.6.2 Controller Address Setting of the Slave Machine .....	24
3.6.3 Displayer Reset .....	25
3.6.4 Communication Connection .....	25
<b>4. Operation Guide .....</b>	<b>27</b>
4.1 Introduction of Operation Menu .....	27
4.2 Interface Operation .....	27

4.2.1	Initial Interface .....	27
4.2.2	Main Interface.....	28
4.2.3	Interface of “on” and “off” .....	28
4.2.4	Current Fault Checking and Resetting.....	30
4.2.5	Password Input and Change .....	31
4.3	Instruction of Menu Interface.....	32
4.3.1	Menu Instruction of “A Setting” .....	32
4.3.2	Menu Instruction of “B Clock” .....	33
4.3.3	Menu Instruction of “C input and output”.....	34
4.3.4	Menu Instruction of “D alarm record” .....	34
4.3.5	Menu Instruction of “E Unit Switch”.....	34
4.3.6	Menu Instruction of “F Maintenance” .....	35
<b>5.</b>	<b>Trouble-shooting .....</b>	<b>37</b>
<b>6.</b>	<b>Maintenance and Repair .....</b>	<b>38</b>
6.1	Daily Repair and Check Items.....	39
6.2	Monthly Periodical Checking Items .....	39
6.3	Monthly Periodical Checking.....	39
6.4	Maintenance Schedule.....	40
6.4.1	About the Machine.....	40
6.4.2	Installation & Inspection.....	40
6.4.3	Daily Checking.....	40
6.4.4	Weekly Check.....	40
6.4.5	Monthly Check.....	40
6.4.6	Trimonthly Checking.....	41
6.4.7	Check Half-yearly .....	41
6.4.8	Yearly Checking.....	41
6.4.9	3 year Checking.....	41

### Table Index

Table 1-1:	Specification .....	12
Table 3-1:	Notice for Lifting Matters.....	19
Table 4-1:	Instruction of Keys .....	27

## Picture Index

Picture 1-1: Series Outline Dimensions .....	11
Picture 1-2: The Illustrative Drawing of SICC-A Modules Grouping.....	11
Picture 2-1: Working Principle .....	16
Picture 3-1: Installation Space .....	18
Picture 3-2: Platform Installation .....	19
Picture 3-3: Hanging and Transporting of the Unit.....	20
Picture 3-4: Combined Installation of Modules .....	20
Picture 3-5: Same Direction Way 1.....	22
Picture 3-6: Same Direction Way 2.....	22
Picture 3-7: Essentials for Electric Wiring.....	24
Picture 3-8: Communication Line Connection.....	26
Picture 3-9: Communication Interface Diagram.....	26
Picture 4-1: Operation Menu.....	27



# 1. General Description



Read this manual carefully before operation to prevent damage of the machine or personal injuries.

SICC-A series are applicable for cooling moulds to reduce products molding cycle, also they are available in the cooling of equipments in order to maintain a normal temperature. Besides, they are suitable for other industries with the need of cooling.



Model: SICC-60A

## 1.1 Coding Principle

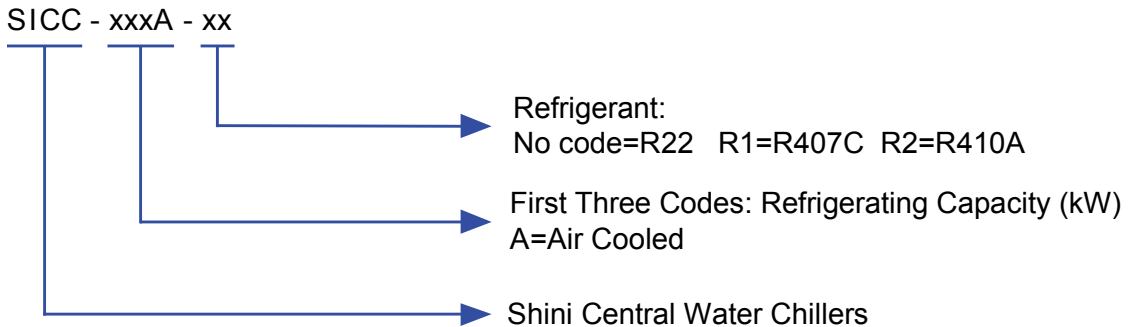

Note:

CE=CE Conformity

## 1.2 Feature

- Modularized design makes it easier to combine module units 1 to 15. Cooling capacity can be enlarged by increasing the number of modules or choose appropriate modules to connect to existing system.
- The water route of the modules can be linked via linking one module to the inlet/outlet water tube. No need to install the inlet/outlet water tube for each module alone. The soft rubber tube is used to connect the modules, thus it is very convenient to construct.
- Compact structure of module unit is convenient for maintenance, and the certain adjacent distance could be left for installation as construction demand.
- Adopts imported components like scroll compressor, expansion valve which ensure stable performance. The whole unit will not stop due to one module failure.
- When the whole unit is running, the microcomputer will auto adjust the performance of each module or open / shut respective module unit according to system load. The module unit adopts double compressors and its power adjustable range is enlarged after combination to save up power whenever possible.
- Wired control system enables the main unit and its controller to be separated from each other.



All service work should be carried out by a person with technical training or corresponding professional experience. The manual contains instructions for both handling and servicing. Chapter Six, which contains service instructions intended for service engineers. Other chapters contain instructions for the daily operator.

Any modifications of the machine must be approved by SHINI in order to avoid personal injury and damage to machine. We shall not be liable for any damage caused by unauthorized change of the machine.

Our company provides excellent after-sales service. Should you have any problem during using the machine, please contact the company or the local vendor.

Headquarter and Taipei factory:

Tel: (886) 2 2680 9119

Shini Plastics Technologies (Dongguan), Inc:

Tel: (86) 769 8111 6600

Shini Plastics Technologies India Pvt.Ltd.:

Tel: (91) 250 3021 166

## 1.3 Technical Specifications

### 1.3.1 SICC-A Series Outline Dimensions

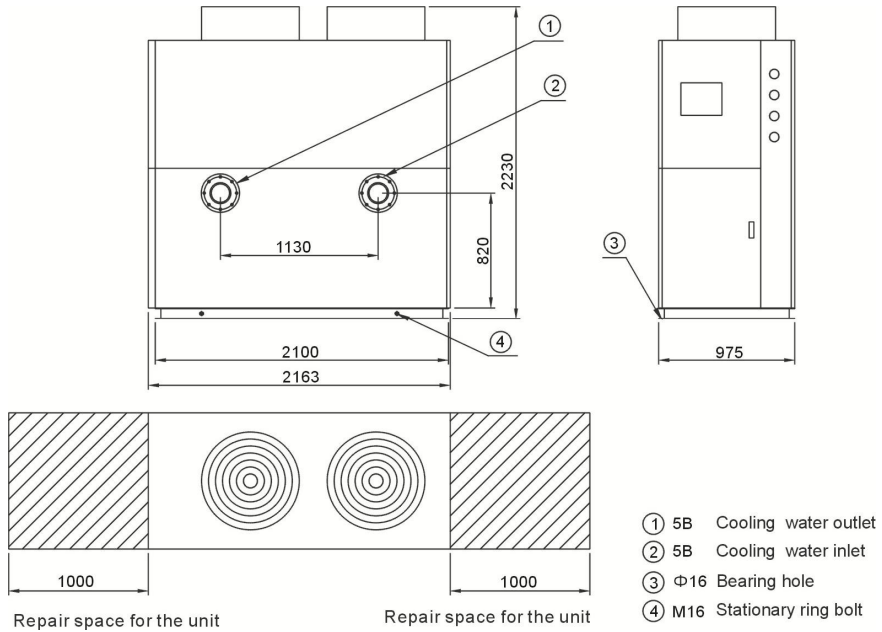

(SICC-60A)

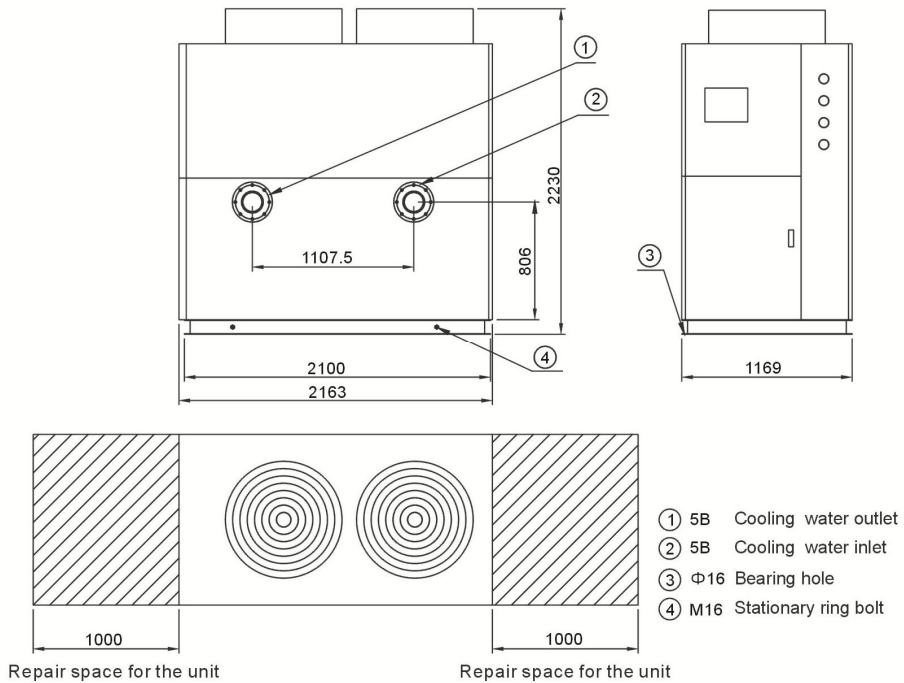

(SICC-90A)

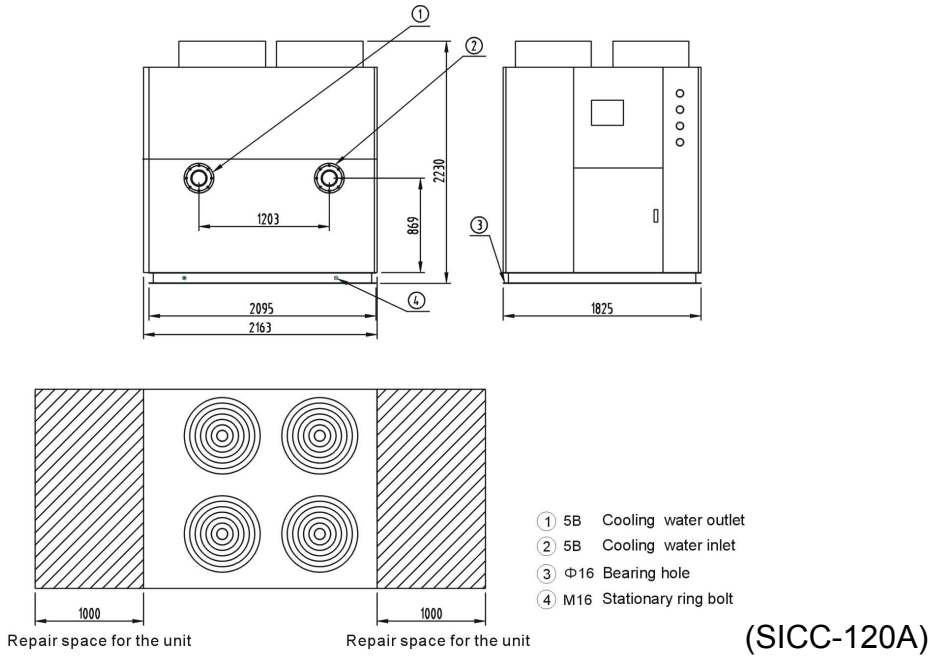

Picture 1-1: Series Outline Dimensions

### 1.3.2 The Illustrative Drawing of SICC-A Modules Grouping

The illustrative drawing of SICC-A modules grouping

Unitage: mm

Type	Model	Unit size(A)	Combination size
Module machine	SICC-60A	975	$N \times A + (N-1) \times 200$
	SICC-90A	1170	
	SICC-120A	1825	

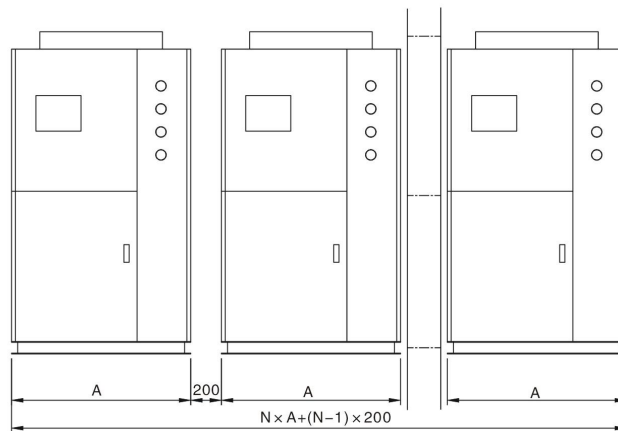

Note: The space of module unit installation should be 200mm.  
 For air ventilation and effect cooling. Refer to figure guidance.

Picture 1-2: The Illustrative Drawing of SICC-A Modules Grouping

### 1.3.3 Specification

Table 1-1: Specification

Items		Model			
		SICC-60A	SICC-90A	SICC-120A	
Refrigeration capacity	kW	60	90	120	
	kcal/hr	51,600	77,400	103,200	
Power		3 $\Phi$ , 400VAC, 50Hz			
Total power	kW	19	28	37	
Running current	A	33	48	61	
Startup current	A	140	175	230	
Compressor	Type	--	Hermetic scroll		
	Power	kW	8.5 $\times$ 2	13.6 $\times$ 2	18.8 $\times$ 2
	Cank case heater	kW	0.07 $\times$ 2	0.07 $\times$ 2	0.09 $\times$ 2
Refrigerant	Type	--	R22		
	Filling quantity	kg	15	18	36
Evaporator	Type	--	Shell and tube evaporator		
	Cooling flow	m <sup>3</sup> /hr	10.3	15.5	20.6
	Pressure loss	kPa	27	40	49
	Water coupler	inch	5	5	5
Condenser	Type	--	Tube-fin air-cooled condenser		
	Blower power	kW	1.68	1.68	3.72
	Air quantity	m <sup>3</sup> /hr	26,000	39,000	52,000
Machine Dimensions	Width (W)	mm	2163	2163	2163
	Depth (D)	mm	975	1170	1825
	Height (H)	mm	2230	2230	2230
Weight	Before packing	kg	720	820	1300
	After packed	kg	760	870	1350
Noise level dB(A)	dB(A)	71	82	74	
Measures exchange		1 kW = 860 kcal/hr    1 RT = 3,024 kcal/hr 10,000 Btu/hr = 2,520 kcal/hr			

Note: 1) Refrigeration capacity is measured based on the flow 0.172 m<sup>3</sup> / (h.k W) and the outlet temperature 7°C of chilled water under the environment temperature of 35°C

## 1.4 Safety Regulations

Strictly abide by the following safety regulations to prevent damage of the machine or personal injuries.

### 1.4.1 Notice Items for Safe Operation

Read the following regulations before installation or using under the consideration of safety.

- 1) Do not drop water in the electrical part to avoid insulation damage.
- 2) Put device connect to ground according to electrician operating regulation to avoid creepage.
- 3) Any tubes or electrical device mount on air conditioner must be installed by professional technicians.
- 4) Please install units in flat and ventilative place and keep suitable distances.
- 5) Keep away from fire source, such as water heater.gas and electric stove.
- 6) Avoid being exposed to weather.
- 7) Construct according to installation instructions and notice.
- 8) This type of air-conditioner is designed for adults. Keep children away from it.
- 9) Any deeds trying to change its specification are dangerous.
- 10) Don't use evaporable solvents, oil or toluene to avoid accidents.
- 11) Ensure this machine not to press on the electrical wires to avoid creepage and burning.
- 12) Do not touch the machine with wet hands in case of accident.
- 13) Under no circumstances should you try to repair the water chiller. Because the untrained may cause greater damages or failures, please inquire local service agents.
- 14) Do not pour water or detergent on the surface of machine when cleaning it. Please wipe it with cloth or neutral detergent.
- 15) Do not place things on the upper surface of the water chiller inorder to avoid danger during running.
- 16) Connect the water chiller to special electricity supply. It is forbidden to share circuit with other devices.
- 17) Do not change or repair the electrical wires without authority.
- 18) Do not insert anything into air outlet of the water chiller to avoid damage or danger.

### 1.4.2 Safety Signs and Labels



Attention!

The installation of electrical devices should be conducted by professional electricians.

During repairing and maintenance, must turn off the main switch and control switch.



Warning!

High voltage danger!

Put up this symbol in the shell of the electric cabinet!



Warning!

Be careful! This symbol stands that take careful hereby!



Attention!

No need for regular inspection because all the electrical parts in the control unit are fixed tightly!

### 1.4.3 Signs and Labels

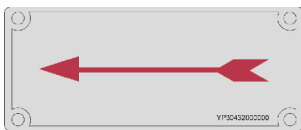

This is for indicating motor rotating direction.

It indicates the pump running direction, please confirm it.

When phase reversal happens, the alarm sounds and indicator on control panel will indicate. Please exchange the place of the two electrical wires to solve this problem.

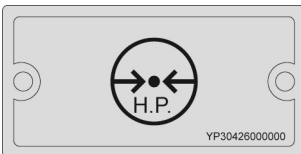

High pressure gauge: display pressure in the high-pressure side of refrigerant system.

	<p>Low pressure gauge: display pressure in the low-pressure side of refrigerant system.</p>
	<p>Drainage port: water outlet of water system.</p>
	<p>Chilled Water Outlet (To Mould)</p>
	<p>Chilled Water Return(From Mould)</p>

## 1.5 Exemption Clause

The following statements clarify the responsibilities and regulations born by any buyer or user who purchases products and accessories from Shini (including employees and agents).

Shini is exempted from liability for any costs, fees, claims and losses caused by reasons below:

1. Any careless or man-made installations, operation and maintenances upon machines without referring to the Manual prior to machine using.
2. Any incidents beyond human reasonable controls, which include man-made vicious or deliberate damages or abnormal power, and machine faults caused by irresistible natural disasters including fire, flood, storm and earthquake.
3. Any operational actions that are not authorized by Shini upon machine, including adding or replacing accessories, dismantling, delivering or repairing.
4. Employing consumables or oil media that are not appointed by Shini.

## 2. Structure Characteristics and Working Principle

### 2.1 Working Principle

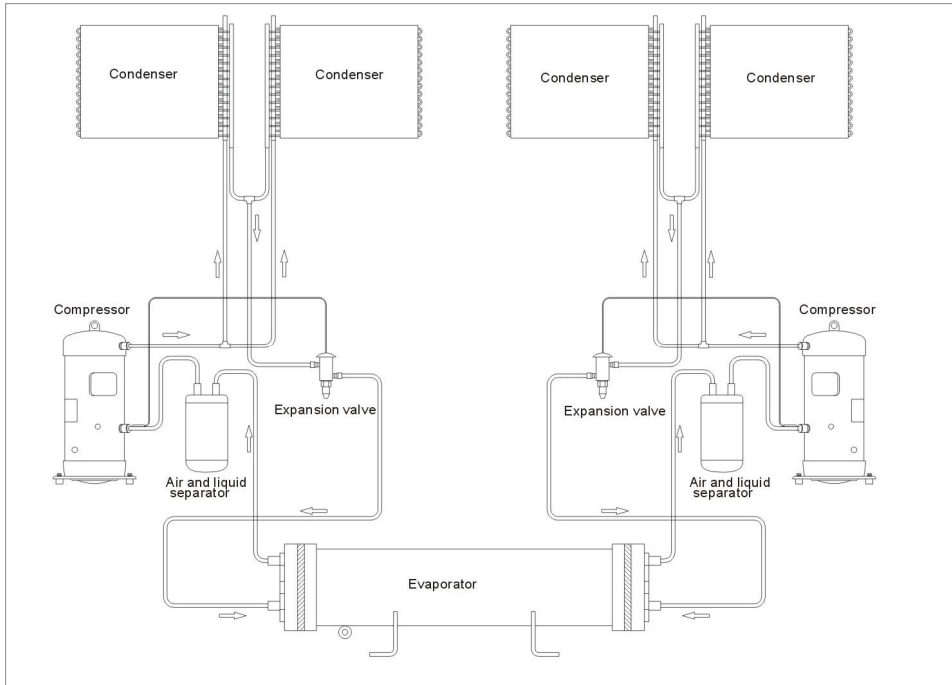

Picture 2-1: Working Principle

Cooling cycle: The high temp. high pressure air exhausted from high pressure air output of the compressor enters the fin-style airside heat exchanger. At the same time, worked as condenser, the fin-style airside heat exchanger condenses the high temp. high pressure air to the liquid, which enters the expansion valve after filtration. It then gets into the tube evaporator after depressurized expansion. The low temp. low pressure saturated refrigerant absorbs the heat of cooling water to reduce the temperature. The refrigerant is at the low temp. low pressure gas state at the refrigerant outlet of the tube evaporator, which enters gas-liquid separator for gas and liquid separation. Then, the gas returns to the low pressure suction end of the compressor. High pressure air output of compressor → condenser (airside heat exchanger) → filter → expansion valve → evaporator (waterside heat exchanger) → gas-liquid separator → low pressure suction end of compressor.



### 3. Installation and Debugging

**Note: Before installation, please read this chapter carefully and install according to the procedures as follows!**

Install the water chiller near windows or places with good air flowing because air-cooled central water chiller needs a good heat-releasing condition. If the water chiller is installed inside the factory, then the surrounding temperature should not be higher than 35 centigrade and there must have fans to make air-flow flow fluently or air tube piping the hot air produced by water chiller outside. If the water chiller is installed outdoor, a veil is needed to cover the top of the chiller.

#### 3.1 Installation Notice Items

- 1) Install pipe work system according to scheme of wiring. Protect water chilling pipes with hear-insulating materials.
- 2) Make sure that the diameter of the recycling pump pipeline not less than that of condenser's connection tube. (Install the inlet or outlet pipeline system according to the drawing of the assembly line) Large-diameter tube should be used to connect to cooling water for long-range transmission.
- 3) The very top of the cooling water recycling loop system must be configured with self-discharging valve, the lowest with drain valve.
- 4) Install filter in the cooling water recycling loop due to bad water quality in the water source and wash the filter at certain times.
- 5) Test if the pipeline leaks after installation. Wrap insulating layer onto the cooling water recycling pipe to aviod loss of refrigeration capacity and pipeline leakage.

**Note: Power connection must be conducted by professional electricians! Do not change the circuit of the water chiller without our company's authority. If the machine is damaged by unauthorized change we are not responsible for this.**

#### 3.2 Select Installation Site

- 1) No heat source existence nearby to acoid efficiency reduction due to absorbing hot air.
- 2) No impact imposed by high temperature, vapor or oil stain.

- 3) Avoid being splattered by water vapor when choosing installation site near cooling water tower, so to avoid any short circuit or creepage.
- 4) Proper ventilation without hindrance for air inhaled exhaled.
- 5) No existence of inflammable substance.
- 6) When using concrete bearing platform, the platform must be firm and flat. Install shockproof mat in the bolt of bearing platform if necessary.
- 7) Set apart some service space. Space ranges are recommended as shown in figure 3-1.

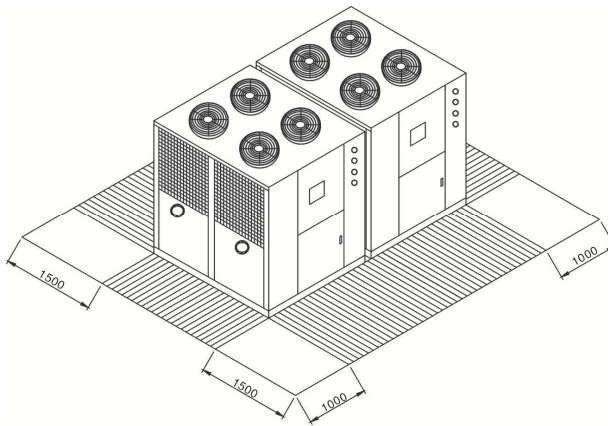

Length unit: mm

Picture 3-1: Installation Space

### 3.2.1 Bearing Platform

- 1) The unit should be installed on concrete or steel structure bearing platform that is firm and the surface of the bearing platform should be smooth and flat. The intensity of the platform should hold the whole unit, if the intensity is not strong enough, it is easy to cause vibration and noise.
- 2) The surface of the concrete base platform normally has a composition as horizontal ornament and with waterproof treatment, the surrounding of it should have drainage sink placed, and the slope angle should be no less than 0.5%, and the slope should lead to drainage outlet.
- 3) In order to maintain quiet operation and prevent the vibration and noise transmission from interfering the under floors, the absorber should be laid between the unit base and base platform. Please maintain horizontal when install the unit and mount anti vibration pad when it is necessary.
- 4) In order to keep connection pipe from being twisted to crack by earthquake, typhoon, or by long time running caused movement. The fixation method

should be taken into consideration, refers to following examples for platform installation and fixation:

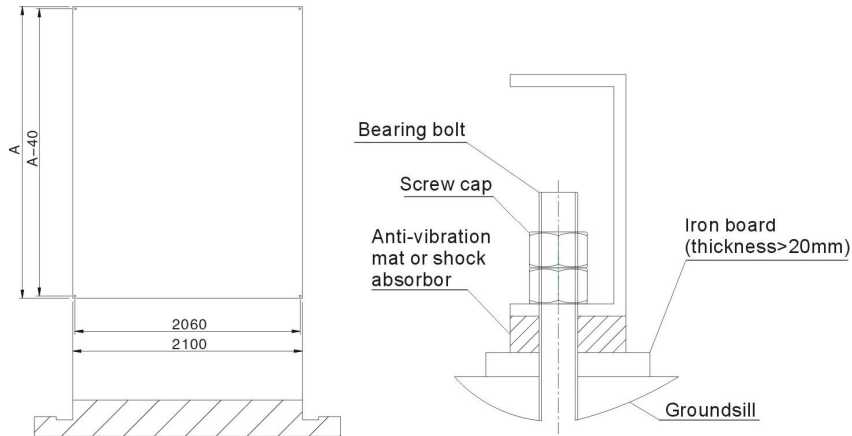

Picture 3-2: Platform Installation

**Note: Photo 3-2 the platform size is for module unit, pay special attention to the real location and size of installation holes.**

### 3.2.2 Hanging and Transporting of the Unit

- 1) Propose plans of hanging and transporting should be made before practice, which include entering date for each unit, external dimension, weight, transport path, reserved holes, and hanging and transporting device as well.

Table 3-1: Notice for Lifting Matters

Items		Check points
Transporting	Path	1. Check aisle, stair gate and transporting path. 2. Check roof, base room and hanging path.
	Unload	1. Check the weight of the unit. 2. Prepare unload devices. 3. Check the temporary laying place and keep the unit clean.
	Transporting	1. If the large-scale machine can be decomposed, then decompose it and transport each part respectively and then combine them finally. 2. If the large-scale machine cannot be decomposed, then dig hole in the wall or earth to transport it.
Path adjustment		Adjust with the wall, floor to facilitate transporting.
Others		Arrangement of Labor and hanging device; problems of worker and unit safety.

- 2) According to safety command, when hanging and transporting units, assign special person to direct and there must be warning and precaution measures

to ensure safety of people and machines.

- 3) Consider the weight of the unit. Take woven belt as hanging device and add bearing articles to avoid damage to metal board. Keep horizontal or vertical state. It is forbidden the unit inclined by over 30 degrees.
- 4) Protect the unit from being cut or deformation. Place protective mat or wood poles in the contact places between woven belt and the unit.

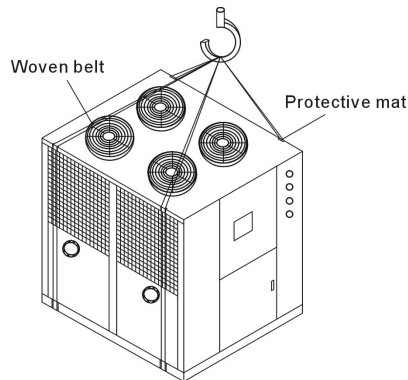

Picture 3-3: Hanging and Transporting of the Unit

### 3.3 Combined Installation of Modules

- 1) Disassembly the sideplates around the machine, calibrate the cooling water inlet to combine the modules. Use rubber soft pipe to connect the module's chilling water pipe.
- 2) The non-exist end of the cooling water pipe should be fixed by flange.
- 3) Refers to wiring diagram to tandem the communication line to next submodule, the communication line of which tandems to next submodule thereby, and set the address of the module (As Chapter 3.6 to set up the communication).

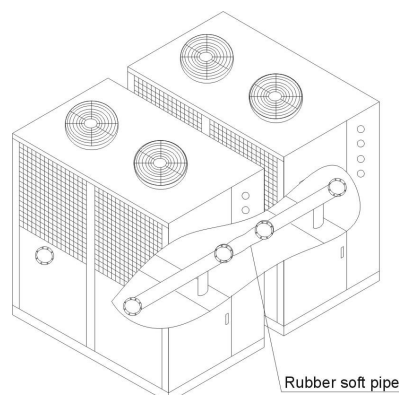

Picture 3-4: Combined Installation of Modules

### 3.4 Water System Tubing

- 1) The inlet /outlet pipes and valves of the unit should have themselves insulated. The outside parts should have protective veil to prevent the thermo lost and dewfall happen and this brings no impact on building structure and anti-freezing when it is in winter.
- 2) To ensure that there is enough water in the water-side exchanger and pipeline system so to avoid its internal icy water comes to freeze up, over low pressure and bad oil return rate within system when refrigerating, there after lead to the failure of the compressor and burn down to the worse. So water flow switch should be mounted at the water outlet side and was controlled chainly with compressor.
- 3) If closed circuit type water distribution pipelines are used, an inflated water tank should be placed higher by at least 1m than top of the whole set of water distribution pipelines to buffer the water volume's expansion or contraction and the isolated backup water pressure to water distribution pipelines' influence. Check valve should not be mounted at the outlet of inflated water tank so to avoid pipe leakage or crack.
- 4) The pump of the unit should be mounted at the water inlet of the main module machine.
- 5) Avoid air left in the water system, Install automatic exhaust steam discharging valve in the highest position of all the water distribution pipes. The horizontal pipe of the water distribution system must be laid with an inclination of 1/250.
- 6) There should have flexible joint, flange joint and break valve for later maintenance.
- 7) There mameter and pressure meter should be set in the inlet and outlet of the unit to facilitate daily check.
- 8) There are same directions way and opposite direction way to install the water pipe of the module unit.

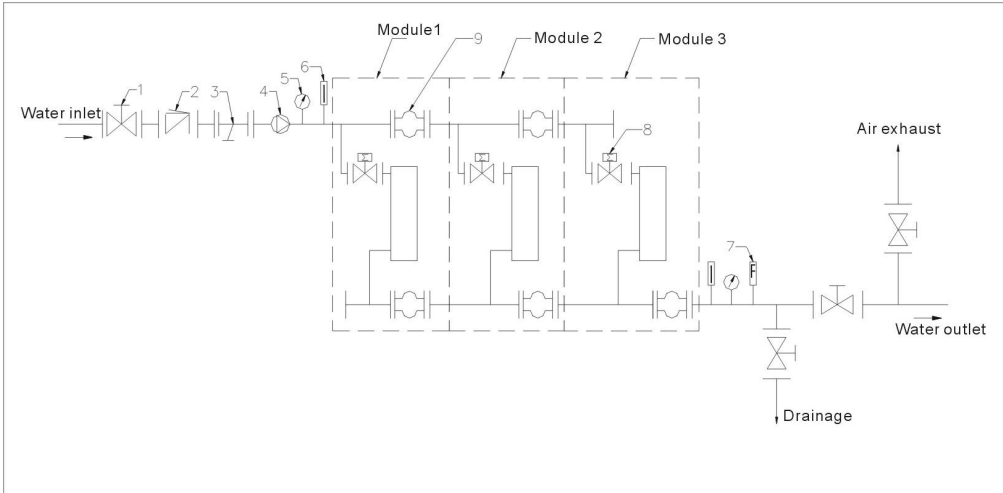

Names of Parts:

- |               |                   |                            |
|---------------|-------------------|----------------------------|
| 1. Stop valve | 2. One way valve  | 3. Y type filtration valve |
| 4. Pump       | 5. Pressure meter | 6. Thermometer             |
| 7. Flowmeter  | 8. Solenoid valve | 9. Rubber soft pipe        |

Picture 3-5: Same Direction Way 1

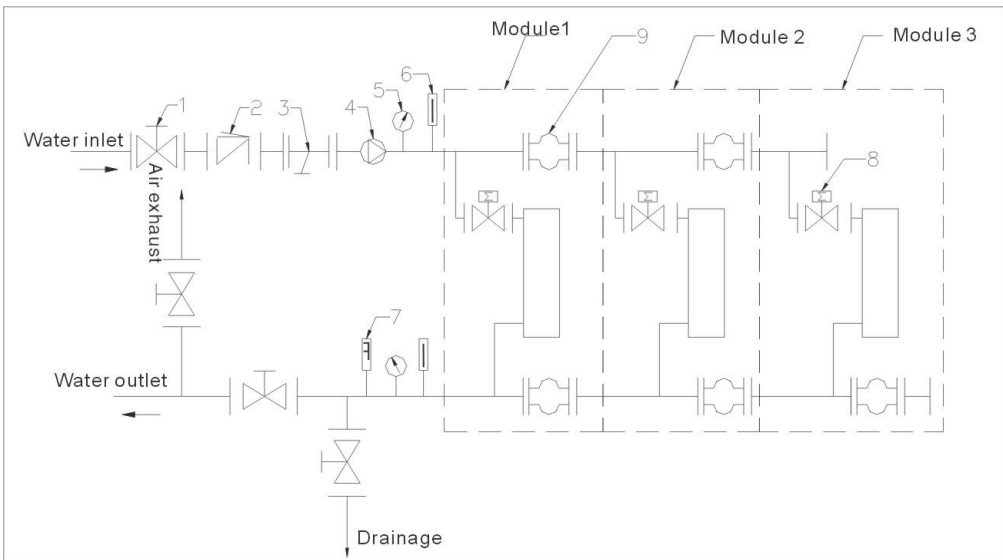

Names of Parts:

- |               |                   |                            |
|---------------|-------------------|----------------------------|
| 1. Stop valve | 2. One Way valve  | 3. Y type Filtration valve |
| 4. Pump       | 5. Pressure meter | 6. Thermometer             |
| 7. Flowmeter  | 8. Solenoid valve | 9. Rubber soft pipe        |

Picture 3-6: Same Direction Way 2

## 3.5 Essentials for Electric Wiring

- 1) The electricity supply should use special branch circuit.
- 2) Wiring work should be conducted according to relevant national electric standards and grounding.
- 3) Refer to wiring diagram to conduct wiring work. Lock up every contact screws, do not let them loosen.
- 4) The voltage has to be stable when in operation, take all the voltage down fall into consideration, the unit working voltage should maintain at  $\pm 10\%$  within rated voltage. Over high or over low voltage will bring bad effect to the unit.
- 5) The length of the power cable must ensure the voltage gap value between the head and tail of cable be less than  $\pm 2\%$  within rated voltage, if the length can not be shorter. Then enlarge the diameter of the cable.
- 6) The wiring connection between power and unit should be conducted according to electrical regulations with good insulation, after the unit being connected to the power; the terminals of the electrical components resistance should be at least more than  $3M\Omega$ .
- 7) In order to avoid the damage to those electrical devices such as transformer or wiring due to short circuit, and helps to separately control the start/stop of every compressor, every incoming cable needs to equip proper amount of non-fuse breaker (NFB). Showed in the following photo:
- 8) In order to ensure personal safety, to avoid electric shock due to creepage the housing of the unit needs to have a good grounding protective device to avoid electric shock, all the work should be carried out by strictly follow the electrical regulations.
- 9) Specific power supply specifications please refer to the schematic model.

***Note: Make sure the power switch is off before power cable connection.***

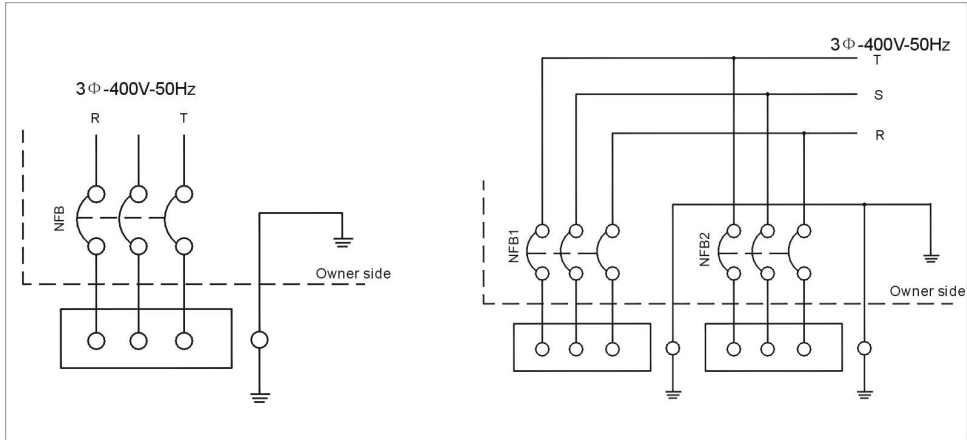

Picture 3-7: Essentials for Electric Wiring

### 3.6 Communication Connection

This series machine adopts modular structure, and signals between modules are communicated based on CPP bus. So the controller of each module should have the only address.

**Note: Please refer to Chapter 4 for the function of each press key on the displayer.**

#### 3.6.1 Setting the Controller Address of the Host Machine

The Water Chiller with displayer has been set as the host machine before delivery. The default of the controller address is 1 (If it isn't 1, modify it to 1, please refer to controller address setting of the slave machine), which doesn't need additional settings.

#### 3.6.2 Controller Address Setting of the Slave Machine

The Water Chiller without displayer has been set as the slave machine before delivery.

The controller of slave machine requires the slave machine to connect with the 220V power cable, which can't use the shielded cable. The common two-core cable is available to connect between the slave machines.

The default of the slave machine's controller address is 1, which requires modification according to actual situation on site. The method is as following:



- 1) Dismantle the displayer from the host machine and connect it to the control board of the salve machine.

***Note: Make sure the communication between the host machine and salve machine is disconnected, and the controller must be powered off when disconnecting the communication.***

- 2) Water Chiller Start
- 3) Press the <Up key>, <Down key> and <Confirm key> , the screen displays the display address, and use the <Up key> or <Down key> to modify the address. If it needs to use the displayer to set the controller address of the Water Chiller, the displayer address must be set as 00 at first.
- 4) Restart the Water Chiller
- 5) When the displayer shows Self test and please wait, continuously press the <alarm key> and <Up key> till the screen displays plan address, and use the <Up key> or <Down key> to modify the address to 2 or other value (it is set according to actual demand on site. For machine No.3, set it as 3).
- 6) Set the controller address of each machine in turn according to this method.

### 3.6.3 Displayer Reset

- 1) After setting the controller address of all the Water Chillers, install the displayer back to the host.
- 2) Start the mainframe of Water Chiller
- 3) Press the <Up key>, <Down key> and <Confirm key> at the same time, and the screen shows display address; use <Up key> or <Down key> to modify the address. If it needs to use Water Chillers of displayer control, it must ensure the displayer address is set as 32.

### 3.6.4 Communication Connection

- 1) Specification of Communication Connection

If the control cable needs to be crossed with the power cable, the angle of cross point must be ensured around the 90 degrees as much as possible, and the control cable can't be parallel to the power cable.

If it needs to be connected parallelly, please refer to the national standard

(*Integrated Wiring System Project Acceptance Specification of Architectural and Architectural Complex GB / T50312-2000* ) and keep enough wire distance ( $> 130\text{mm}$  unshielded communication line,  $> 70\text{mm}$  shielded communication line);

The distance of wire connection and heating pipeline in National standard (GB / T50312-2000) is specified as below: parallel net distance  $> 500\text{mm}$  (unsealed heating pipe) or parallel net distance  $> 300\text{mm}$  (sealed heating pipe).

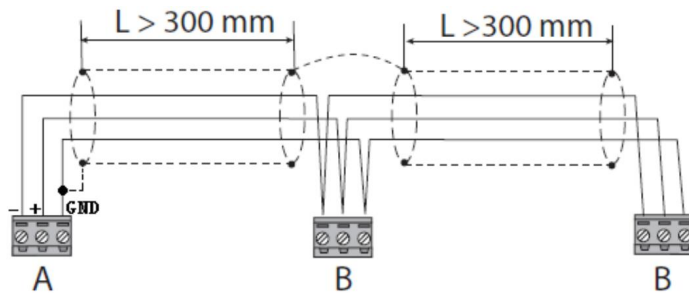

Picture 3-8: Communication Line Connection

## 2) Communication Interface

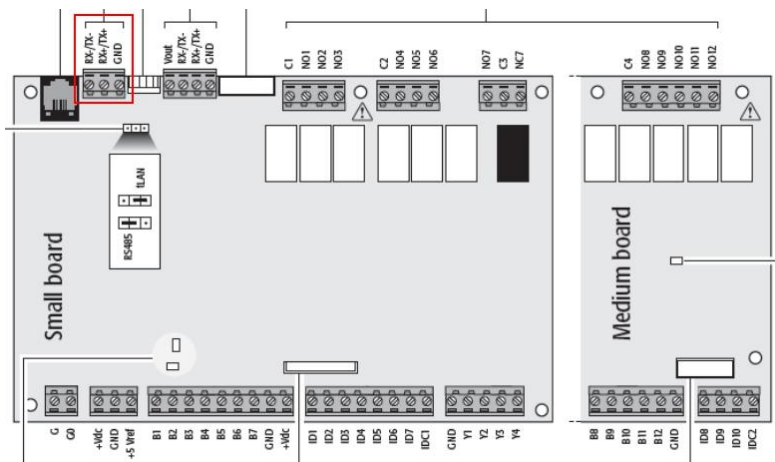

Picture 3-9: Communication Interface Diagram

**Note: The communication cable plug-in and plug-out must be carried out when the controller is powered off. Otherwise, the communication interface would be damaged easily.**

**Note: The communication cable must be connected according to the specification. Otherwise the communication may be abnormal.**

## 4. Operation Guide

### 4.1 Introduction of Operation Menu

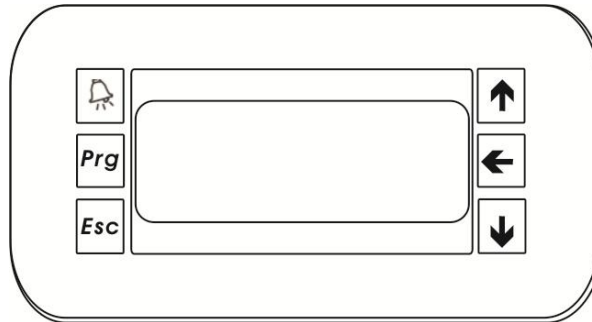

Picture 4-1: Operation Menu

Table 4-1: Instruction of Keys

Keys	Function
-Alarm	Display the alarm list of operations or manual resetting of faults
Prg	Enter the main menu tree
Esc	Return to the last screen
-Up	Turn the list up or increase the value on the displayer
-Down	Turn the list down or decrease the value on the displayer
-Enter	Enter the selected sub-menu, or confirm the set value

## 4.2 Interface Operation

### 4.2.1 Initial Interface

“Initial interface” first appears after the controller is electrified for 40 seconds. If the preheat time of oil has been set, countdown of oil heating would also be shown.

Interface display: If the preheat time of oil has not been set, the interface would automatically skip to “main interface” after 20 seconds.

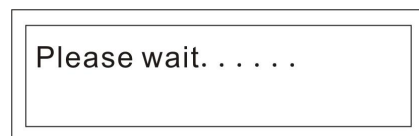

Interface display: the preheat time of oil has been set, and the interface would automatically skip to “main interface” after oil heating.

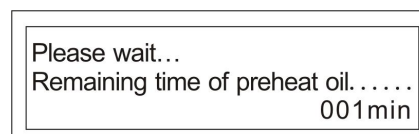

#### 4.2.2 Main Interface

Display the inlet/outlet water temp of the system.

Display the “on” and “off” state of the unit.

Display the operation state of the unit: refrigeration/ heating.

Display the “on” and “off” state of water pump, compressor and blower.

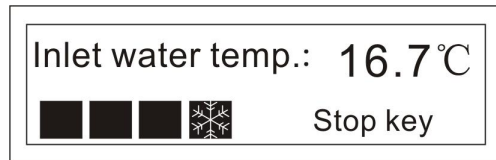

#### 4.2.3 Interface of “on” and “off”

There are three kinds of startup and shutdown of the unit: keyboard startup and shutdown, timed startup and shutdown as well as startup and shutdown with remote-control digital value.



The unit can be activated when it meets the following conditions:

- 1) The input function of remote-control digital value has not been activated, or the digital value is in “on” state when the function is running.
- 2) Timing switch is not activated or the current time is in the period of “on”.
- 3) There is no severe alarm.

- 4) The unit has been activated by keyboard.
- 5) The main machine unit has been activated (this function only works in the subordinate machine).

***Note: If any of the above conditions is not met, the unit will be shut down and its state will show the cause. The priority of keyboard startup and shutdown is higher than that of other models, so the system state will first show the keyboard shutdown when there are several causes resulting in the system shutdown.***

##### 4.2.3.1 Interface of Keyboard Startup and Shutdown

Under the main interface, you can enter the “keyboard startup interface” after pressing the key of . And keyboard startup can be achieved after  is pressed again, under the condition that the unit is in “off” state and both timed and remote-control startup as well as shutdown are not activated.

This is the “keyboard startup interface”. When neither timed startup and shutdown nor remote-control one is not

activated, the key of ← can be pressed to turn on the machine. At that time, the keyboard of the unit is in “on” state.

State: Stop key	0.01
Pressure ENTER key	startup

When the unit is in “on” state, press the key of "ENTER" under the main menu, and then “keyboard shutdown interface” appears. Under this interface, the key of "ENTER" can be pressed to turn the keyboard off.

This is the “keyboard shutdown interface”, in which the key of "ENTER" is pressed to turn the keyboard off.

State: Machine start	0.01
Pressure ENTER key	shutdown

Keyboard startup and shutdown consists of two ways: startup and shutdown of the whole network and that of subordinate machine.

- 1) Startup and shutdown of whole network: when the unit gains access to the Internet, the whole network unit is managed by the main machine. Once the main machine is turned on, all

subordinate machines will be forced to start. And when the main machine is in “off” state, all subordinate machines will be turned off.

- 2) Startup and shutdown of subordinate machine: provided that the unit has access to the Internet, the subordinate machine can be turned on and off only when the main machine is in “on” state.

**Note: when “U: 01” is displayed on the upper right corner of “interface of keyboard startup and shutdown” and data setter shows the state of main machine, keyboard startup and shutdown means the startup and shutdown of whole network. When any value from “U: 02” to “U: 16” is displayed and data setter shows the state of subordinate machine, keyboard startup and shutdown refers to the startup and shutdown of subordinate machine.**

#### 4.2.3.2 Interface of Timed Startup and Shutdown

Users can set different periods of time to turn on and turn off the unit in a day or a week. Timed startup and shutdown consists of 4 time

zones, which expand from F1 to F4. The interface setting is illustrated in detail in the menu interface instruction [B04] and [B05].

F1: F1 is divided into two zones, in which timed startup and shutdown can be set.

F2: F2 has only one zone, where timed startup and shutdown can be set.

F3: always “on”    F4: always “off”

Take “F1” for example, the switch unit of a day is presented above:

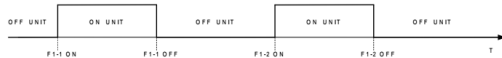

Take “F2” for example, the switch unit of a day is presented above:



In a week, one can choose any one from F1 to F4 when setting timed startup and shutdown, and the interface setting is illustrated in detail in the menu interface instruction [B06].

Provided the settings are: F1 8:00-12:00 and 14:00-17:00; F2 8:00-17:00, and the followings are set in the interface [B06]: F1 for Monday, F2 Tuesday, F3 Wednesday and F4 Thursday.

Thus, on Monday, the unit is “on” in the periods of 8:00-12:00 and 14:00-17:00, and is “off” in the rest of time. On Tuesday, the unit is “on” in 8:00-17:00 and “off” in the rest of time. Besides, the unit is always open on Wednesday and always closed on Thursday.

Note: timed startup and shutdown only works when keyboard is in the state of “on” and long-distance startup and shutdown is not used.

#### 4.2.3.3 Interface of Startup and Shutdown with Remote- control Digital Value.

Users can turn on and turn off the unit remotely with “on” and “off” signals of digital value, and the interface setting is illustrated in detail in the menu interface instruction [B07].

**Note: long-distance startup and shutdown only works when keyboard is in the state of “on” and timed startup and shutdown is not adopted.**

#### 4.2.4 Current Fault Checking and Resetting



When there is something wrong with the unit,  will light up, and if you press this key, you can enter the “interface of fault checking”.

Display the unit code that has fault

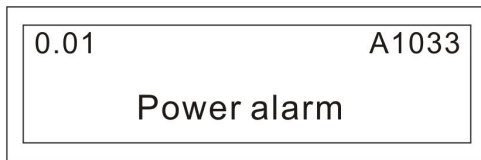
Display the cause of fault







When the external alarm signal of current fault becomes free, the key of  under the “interface of fault checking” can be pressed to give a reset alarm, and then the unit will start again and the screen will automatically skip to the “main interface”.

If there are many faults, keys of  and  can be pressed to check other alarms of them.

**Note: under the “interface of fault checking”,  can only be pressed to reset the fault of current selected unit. If you want to reset the fault of other units, you must firstly switch to the target unit and then repeat the operation.**





#### 4.2.5 Password Input and Change

Enter the interface of password input, and the cursor blinks after  is pressed. At that time, keys of  and  can be pressed to

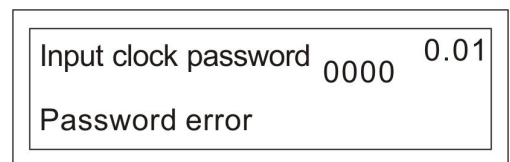
change the value. When you are sure the displayed number is correct, press the key of . If the password is correct, the interface would automatically skip to the next one; if the password is not the right one, you would be prompted to input the password again.

Password error:







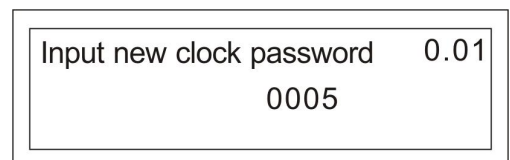

Enter the interface of password input, and the cursor blinks after  is pressed. At that time, keys of  and  can be pressed to change the value. When you are sure the displayed number is correct, press the key of , and the password can be changed.

Change the value into 5 after pressing the key of , and press this key again to affirm the current clock password.



## 4.3 Instruction of Menu Interface

Press “Prg” in any interface of function tree to enter the main menu.

Main Menu Catalogue	
A	 Setting
B	 Clock
C	 Input and Output
D	 Alarm Record
E	 Switch Unit
F	 Maintenance
G	 Plant

In the main menu, press the keys of  $\uparrow$  and  $\downarrow$  to select a submenu of the first stage with cursor, and then press  $\leftarrow$  to enter this submenu, in which  $\uparrow$  and  $\downarrow$  are pressed to page up and down. If there is also a second submenu, the previous step can be repeated to enter this submenu. The followings are the detailed interface instruction of all submenus:

### 4.3.1 Menu Instruction of “A Setting”





In the “main menu”, select the “A  set point” with cursor and then enter its submenu by pressing  $\leftarrow$ . Keys of  $\uparrow$  and  $\downarrow$  can be pressed to page up and down in this submenu.

Interface Index	Description of Displayer	Default	Unit	Description of Function
A01	Current set point	12	°C	Display the target temp of control, and select the set point according to winter/summer and water outlet/inlet
A02	Set point of controlled water inlet in summer	12	°C	Alter the target temp of water inlet control in summer, and the temp is only displayed when water inlet is controlled
	Set point of controlled water inlet in winter	40	°C	Alter the target temp of water inlet control in winter, and the temp is only displayed when water inlet is controlled
A02	Set point of controlled water outlet in summer	7	°C	Alter the target temp of water outlet control in summer, and the temp is only displayed when water outlet is controlled.
	Set point of controlled water outlet in winter	45	°C	Alter the target temp of water outlet control in winter, and the



				temp is only displayed when water outlet is controlled.
A03	Control return difference	2	°C	Alter the control range, i.e. control the deviation value of target temp
A04	Water inlet resetting in summer	10	°C	Only when water outlet temp is in loading zone and water inlet temp is higher than the reset temp can the compressor be turned up. The temp is only displayed when water outlet is controlled.
	Water inlet resetting in winter	42	°C	Only when water outlet temp is in loading zone and water inlet temp is lower than the reset temp can the compressor be turned up. The temp is only displayed when water outlet is controlled.

#### 4.3.2 Menu Instruction of “B Clock”

In the “main menu”, select “B  clock” with the cursor, and then press  to enter the submenu of “input and output”, where keys of  and  can be pressed to page up and down.

Interface Index	Description of Displayer	Default	Unit	Description of Function
B01	Clock	-	-	Alter the current time
B02	Input the password of clock	0	-	Enter after inputting the correct password. Factory default password: 0000.
B03	Turn on and turn off the unit at fixed time	Yes	-	If “Yes”, startup and shutdown of the unit will be in accordance with the time.
	Change the set point at fixed time	No	-	It can't be set
B04	F1 fixed opening time 1	0	-	The unit will be open in these two periods of time, and be closed in the rest of time.
	F1 fixed ending time 1	0	-	
	F1 fixed opening time 2	0	-	
	F1 fixed ending time 2	0	-	
B05	F2 fixed opening time	0	-	The unit will be open in this period of time, and be closed in the rest of time.
	F2 fixed ending time	0	-	
	F3 always on	0	-	The unit will be open within a day.
	F4 always off	0	-	The unit will be closed within a day.
B06	Weekly fixed time setting	F1	-	Set the way of timed startup and shutdown in a week, with F1-F4 all being available.
B07	Long-distance control	No	-	If “Yes”, startup and shutdown of the unit will be in accordance with the long-distance digital value
B08	Input a new alarm password	0	-	Press the key of  after inputting the

				new password, so the clock password can be changed.
--	--	--	--	---

### 4.3.3 Menu Instruction of “C input and output”

In the “main menu”, select “C  input and output” with the cursor, and then press ← to enter the submenu of “input and output”, where keys of ↑ and ↓ can be pressed to page up and down and to look up the input and output state of the current unit.

### 4.3.4 Menu Instruction of “D alarm record”

In the “main menu”, select “D  alarm record” with the cursor, and then press ← to enter the submenu of “alarm record”, where keys of ↑ and ↓ can be pressed to page up and down and to look up the alarm record of the current unit.

### 4.3.5 Menu Instruction of “E Unit Switch”



In the “main menu”, select “E  Unit Switch” with the cursor, and then press ← to enter the submenu of “unit switch”, where keys of ↑ and ↓ can be pressed to page up and down. Address 1: is the main machine, and address 2-16: is the subordinate one. Data setter can be shared by controller, so one displayer can be shared by 16 controllers. That is to say, datum of 16 controllers can be viewed in one displayer.

When the controller has access to the Internet, unit switch can be made, which is divided into automatic switch and manual one. Condition of automatic switch: when some controller gives an alarm, it will be automatically connected to the displayer. For example, the displayer is connected to the No.1 controller, while it will be automatically connected to the No.2 controller when the latter sounds an alarm. Condition of manual switch: enter the interface of unit switch, and change the value of switching to unit into the one of connecting to controller. Detailed instruction is given in the following table:

Interface Index	Description of Displayer	Default	Unit	Description of Function
E01	Unit address	1	-	Address of the current unit is displayed.
	Switch to the unit	1	-	The displayer switches to the address of another unit.
E02	State of units 1-8	-	-	Display the Internet connection state of module units 1-8. “Yes” means Internet is available.

E03	State of units 9-16	-	-	Display the Internet connection state of module units 9-16. "Yes" means Internet is available.
-----	---------------------	---	---	--

#### 4.3.6 Menu Instruction of "F Maintenance"

In the "main menu", select "F Maintenance" with cursor and then press  to enter the submenu of "maintenance", where there is a submenu of the second stage. Press the keys of  and , select the submenu of the second stage, and then enter it by pressing the keys again. Here is a detailed instruction of all submenus:

Interface Index	Description of Displayer	Default	Unit	Description of Function
Fa Language switch				
Fa01	Current language	Chinese	-	Press "Enter" to switch between Chinese and English.
Fa02	Forbidden language when startup	Yes	-	The interface of language switch doesn't appear when startup.
	Countdown	20	Second	Countdown to the appearance of language switch interface.
Fb System Information				
Fb01	Version	-	-	Display the version of current program and hardware
Fc Summer/ Winter				
Fc01	State	Summer	-	Press "Enter" to switch between summer and winter
Fd Operation Time				
Fd01	Pump operation	0	-	Display the pump's operation time in the current module unit
	Compressor 1 running	1 0	-	Display the running time of compressor 1 in machine unit of current module
Fd02	Compressor 2 running	2 0		Display the running time of compressor 2 in machine unit of current module
Fe Monitoring configuration (used for debugging of manufacturer, so users needn't to set)				
Ff Repair setting (used for debugging of manufacturer, so users needn't to set)				
Fg Manual operation (used for debugging of manufacturer, so users needn't to set)				

##### 1. Summer/Winter

Only in the state of shutdown can the refrigeration and heating operation of the unit be changed, and the change can only be made in the main engine. We can choose refrigeration or heating by the input signal of remote-control digital value and keyboard (1= the top priority)

- 1) Switch between refrigeration and heating: remote control is activated, and the model is chosen through the input signal of digital value.
- 2) Keyboard switch: choose either refrigeration or heating by the menu maintenance parameter, which is presented in the interface [FC01] in detail. No matter which model is chosen, it takes effect only in the state of shutdown.

## 5. Trouble-shooting

Failures	Possible reasons	Solutions
Fan, pump and compressor can not start up	<ol style="list-style-type: none"> <li>1. NO power</li> <li>2. Power switch jumps</li> <li>3. Power fuse is burnt.</li> <li>4. Pump overloads.</li> </ol>	<ol style="list-style-type: none"> <li>1. Wait for power recovery</li> <li>2. Check the power and make it normal</li> <li>3. Change power fuse</li> <li>4. Check and reset or repair the failure.</li> </ol>
Pump runs but compressor can not start.	<ol style="list-style-type: none"> <li>1. The setup value for temperature switch is too high.</li> <li>2. Failure in temperature switch.</li> <li>3. Compressor overloads.</li> <li>4. The setup temperature for compressor is too low (for heat flow)</li> <li>5. No restore after the protective switch jumps.</li> </ol>	<ol style="list-style-type: none"> <li>1. Edit the value.</li> <li>2. Check or change.</li> <li>3. Check and reset.</li> <li>4. Edit the value (for heat flow)</li> <li>5. Check and reset.</li> </ol>
Compressor stops immediately after it starts.	<ol style="list-style-type: none"> <li>1. Air inlet or outlet gets hindered.</li> <li>2. Condenser is dirty.</li> <li>3. Bad ventilation due to bad landform.</li> <li>4. Fan fails.</li> <li>5. The cooling water valve has not been opened.</li> <li>6. Overflow cooling water quantity.</li> <li>7. Cooling medium leaks.</li> <li>8. Compressor overloads.</li> </ol>	<ol style="list-style-type: none"> <li>1. Remove the hindering articles.</li> <li>2. Wash and clean.</li> <li>3. Improve gy client.</li> <li>4. Check and repair.</li> <li>5. Open the valve.</li> <li>6. Check the pump to remove the tube air.</li> <li>7. Repair the leak spot.</li> <li>8. Edit setup value.</li> </ol>
Big Inlet/outlet water temperature difference and over low low-pressure (when cooling flow runs).	<ol style="list-style-type: none"> <li>1. Pipeline blocks due to wrong pipeline switching</li> <li>2. Too much gas in the pipeline.</li> </ol>	<ol style="list-style-type: none"> <li>1. Check the valve of the pipeline and attachments.</li> <li>2. Exhaust the air in the pipeline.</li> </ol>

## 6. Maintenance and Repair

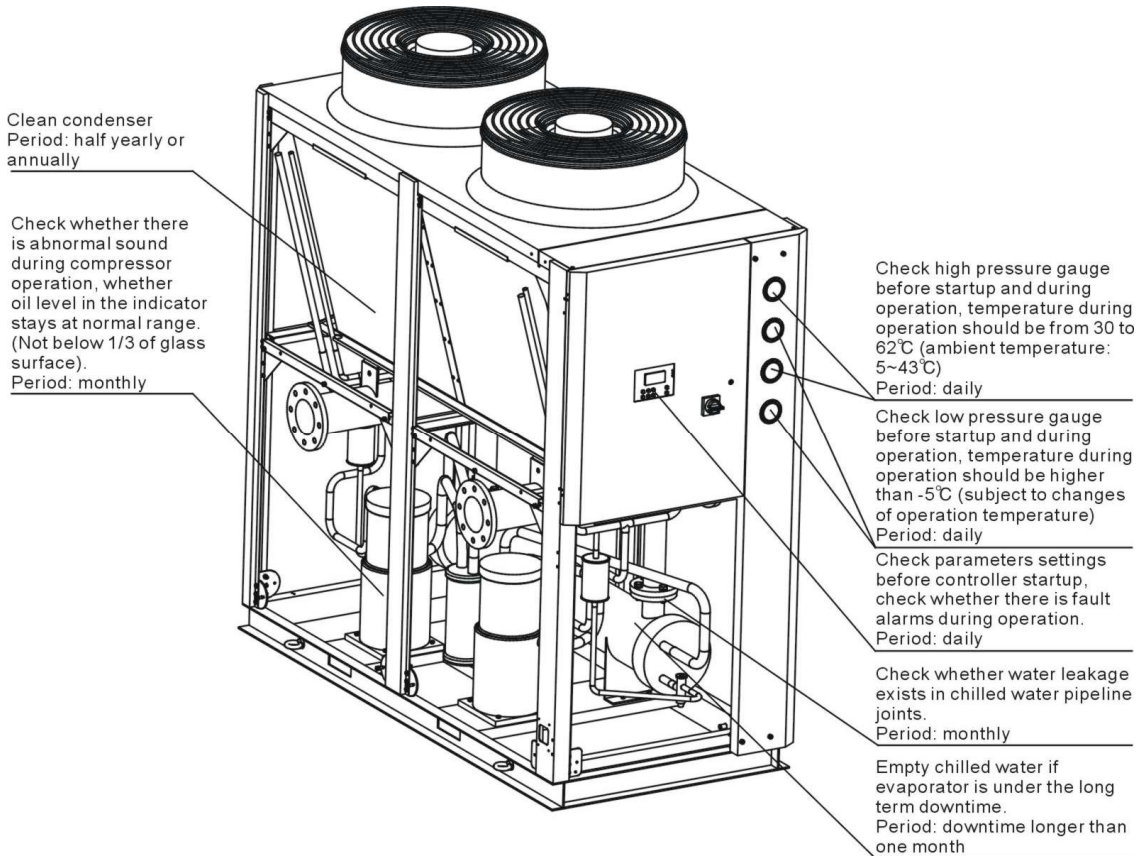

### Note!

All repairing work must be conducted by professional person to avoid personal injury and damage of machine.

Matters require attention when do machine maintenance are as follows:

- 1) Do not stop the machine via cut the power supply unless emergency occurs.
- 2) When failure occurs and machine stops, press the main power switch (alarm light will go out). Check the failure and do not start the machine before trouble-shooting.
- 3) Check the system periodically to expand the system's lifespan and avoid safety accident.
- 4) Dispose the water because water with high PH will accelerate the rust to the copper tube and decrease the heat exchanger's lifespan. Keep the water PH in the scale of 7.0~8.5.

- 5) Keep the unit dry, clean and ventilative.
- 6) The daily operation, unit management, maintenance and repair must be conducted by professional technicians. (Danger exists when disassembling and checking the unit, please take care!)

**Note: Don't disassemble or inspect during machine running!**

## 6.1 Daily Repair and Check Items

- 1) Operation, startup, stop, maintenance and repair works must be conducted by professional technicians to expand the unit's lifespan.
- 2) Daily check includes recording indoor/outdoor temperature, cooled water temperature, voltage, current for further reference, such as adjustment and maintenance.
- 3) Clean the appearance of the unit.

## 6.2 Monthly Periodical Checking Items

- 1) Check if the screws loosen.
- 2) Clean indoor air conditioner box or filter of cool air blower.
- 3) Check if the joint of the pipelines leaks.
- 4) Check the wire to see if there is any damage, the connection is firm and whether contact points are burnt.
- 5) Check the compressor oil level (notice there is no-oil-indicating window).
- 6) Check the cooling water system to see if it is air proof. If there is air, please exhaust it.
- 7) Check the cooling medium pressure.
- 8) Clean the dirt of the condenser.
- 9) Check the inflated tank to see if the supplementary feed water is normal.

## 6.3 Monthly Periodical Checking

- 1) Check according to monthly check items.
- 2) Check the insulation resistance of the compressor to see if it is above 10MΩ.
- 3) Check high voltage switch and low voltage switch to see if their trip off values are normal.

## 6.4 Maintenance Schedule

### 6.4.1 About the Machine

Model \_\_\_\_\_ SN \_\_\_\_\_ Manufacture date \_\_\_\_\_

Voltage  $\Phi$  \_\_\_\_\_ V Frequency \_\_\_\_\_ Hz Power \_\_\_\_\_ kW

### 6.4.2 Installation & Inspection

- Check if the pipe are connected correctly
- Check if the pipe has any leakage
- Check if the sealed joint has any crack

#### Electrical component installation

- Voltage: \_\_\_\_\_ V \_\_\_\_\_ Hz
- Fuse melting current: 1 Phase \_\_\_\_\_ A 3 Phase \_\_\_\_\_ A
- Power phase sequence check

### 6.4.3 Daily Checking

- Check the function of switches.
- Check all wires of the machine.
- Check whether pressure gauges are accurate.
- Check whether compressor temperature is normal.
- Check whether cooling water circulation is normal.

### 6.4.4 Weekly Check

- Check if the joint point is loose.
- Check chiller's protective alarming function.
- Check whether set point of hi-low pressure switch is normal.

### 6.4.5 Monthly Check

- Check the circulated pipe to see if there is any leakage.
- Check whether there are bubbles in liquid indicator.
- Check whether there is abnormal sound in pump.



Check whether there is scale formation in tank.

#### 6.4.6 Trimonthly Checking

Check whether condenser is under blockage.

#### 6.4.7 Check Half-yearly

Check and clean filter and expansion valve.

Check the whole machine condition.

Clean condenser.

#### 6.4.8 Yearly Checking

Check whether the contactor is normal.

#### 6.4.9 3 year Checking

PC board renewal.

No fuse breaker renewal.

# Attachment: Electrical Diagram

