

SYMBOL		MODE					
型号	符号	(a)	(b)	(c)	(d)	(e)	(f)
SG-4360		110	50	160	45-63	55	16
SG-4360H		137	70	160	57-75	70	25

SYMBOL		MODE			
型号	符号	(g)	(h)	(i)	(j)
送料风机		20	7-10	8.1	1.5
加大功率送料风机		63	27-32	28	6

P=30kW
IN=95.8A
粉碎电机
Grinder Motor
(SG-4360)

P=37kW
IN=122A
粉碎电机
Grinder Motor
(SG-4360H)

P=2.2kW
IN=8.1A
分离式送料风机
Suction Motor

P=7.5kW
IN=28A
加大功率
送料风机
Suction Motor

P=0.75kW
IN=3.06A
除尘风机(选配项)
Clean Motor (Option)

机型版本 Ver.E

制图	版号	1
设计	核准	
校对	日期	20220805
标记	更改前	更改后
	更改人	日期

标题	SG-4360(H)	图号	SG-4360(H)-CE-230V-I-1
主电路图		比例	第 1 张
		标准	CE
		机器电压	3φ230V
		机器频率	50Hz



信易電熱機械股份有限公司
Shini Plastics Technologies, Inc.

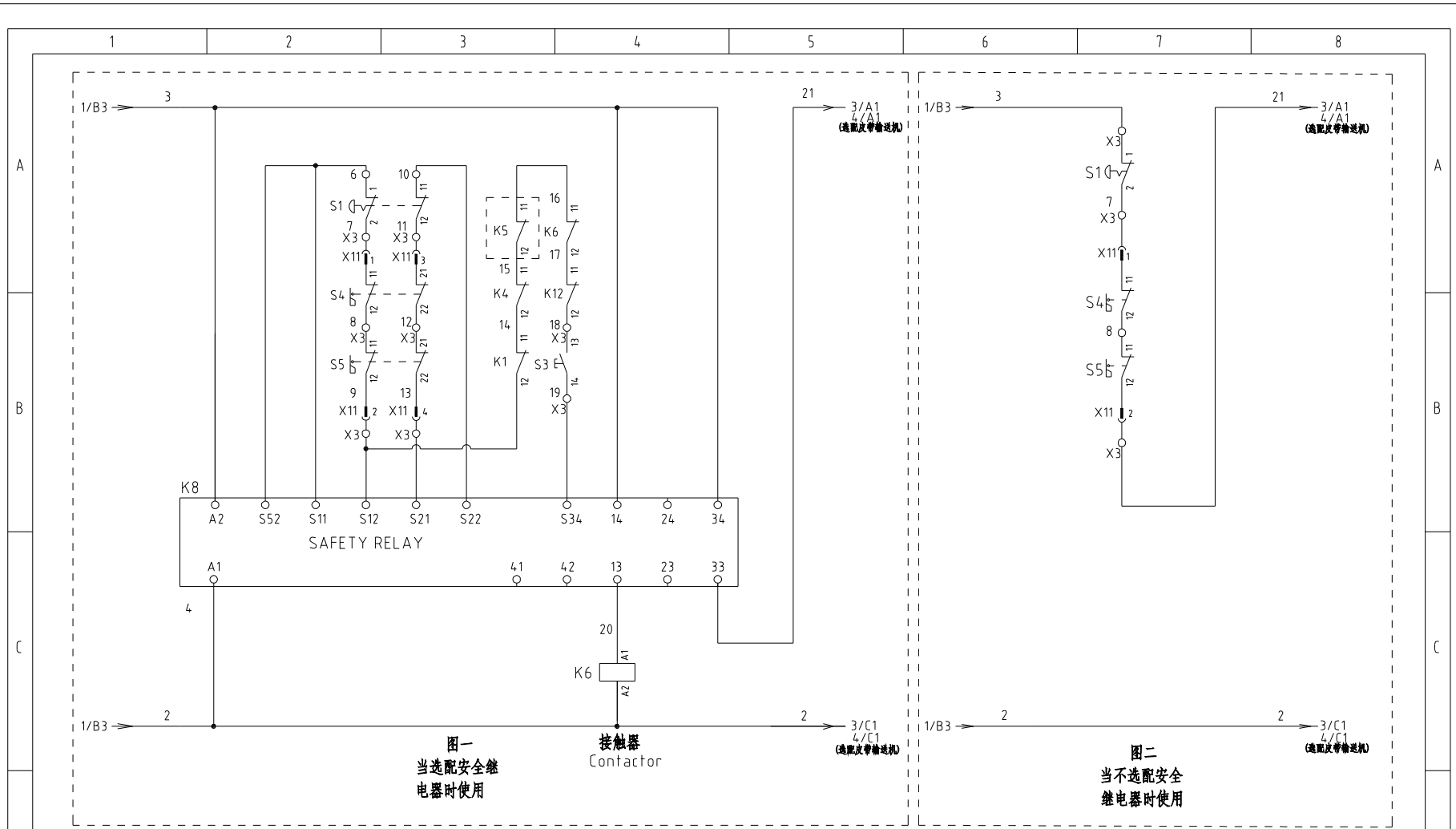

机型版本 Ver.E

制图	版号	I	标题	SG-4360(H) 控制电路图一	图号	SG-4360(H)-CE-230V-I-2	比例	第 2 张
设计	核准						标准	CE 共 12 张
校对							机器电压	3φ230V
标记	更改前	更改后	更改人	日期	20220805		机器频率	50Hz



信易電熱機械股份有限公司
Shini Plastics Technologies, Inc.

比例	第 2 张
标准	CE 共 12 张
机器电压	3φ230V
机器频率	50Hz

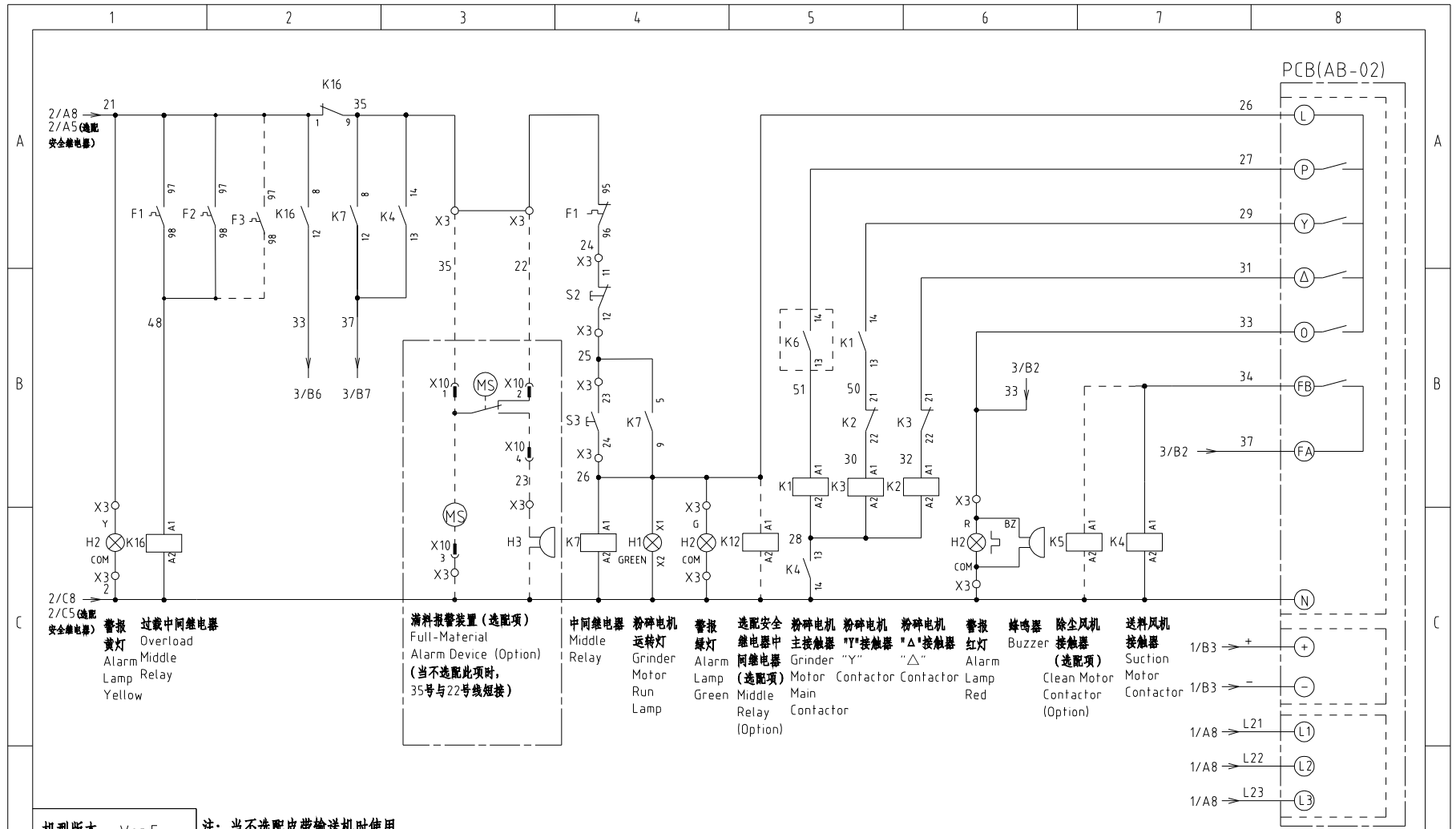

2/C8
2/C5 (选配
安全继电器)

警报 过载中间继电器
黄灯 Overload
Alarm Middle
Lamp Relay
Yellow

送料报警装置 (选选项)
Full-Material
Alarm Device (Option)
(当不选配此项时,
35号与22号线短接)

中间继电器 粉碎机
Middle Relay Grinder
Run Lamp

警报 选配安全
继电器中
间继电器
绿灯 Alarm
Middle Relay (Option)

粉碎机 粉碎机 粉碎机
主接触器 "Y"接触器 "Δ"接触器
Grinder "Y" "Δ" Contactor
Contactor Contactor Contactor

警报 蜂鸣器 除尘风机
红灯 Buzzer 接触器
Alarm (Option)
Lamp Contactor

送料风机
接触器
Suction
Motor
Contactor

机型版本 Ver.E

注: 当不选配皮带输送机时使用。

制图	版号	1	标题	SG-4360(H) 控制电路图二	图号	SG-4360(H)-CE-230V-I-3	比例	第 3 张
设计	核准		标准	CE	机器电压	3φ230V	共 12 张	
校对	日期	20220805	SHINI	信易電熱機械股份有限公司 Shini Plastics Technologies, Inc.	机器频率	50Hz		
标记	更改前	更改后	更改人	日期				



信易電熱機械股份有限公司
Shini Plastics Technologies, Inc.

比例	第 3 张
标准	CE
机器电压	3φ230V
机器频率	50Hz

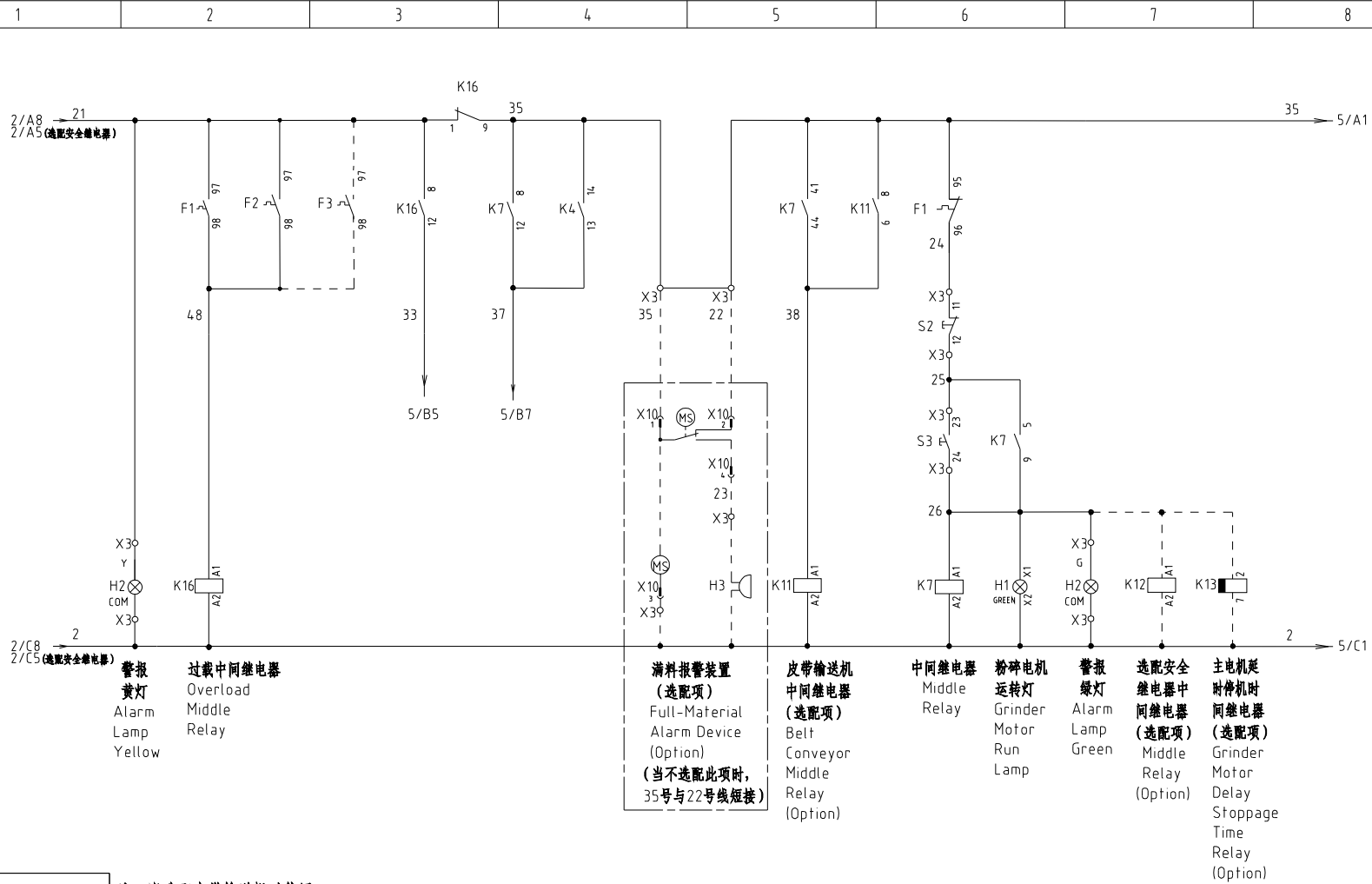

报警
黄灯
Alarm
Lamp
Yellow

过载中间继电器
Overload
Middle
Relay

满料报警装置
(选项)
Full-Material
Alarm Device
(Option)
(当不选配此项时,
35号与22号线短接)

皮带输送机
中间继电器
(选项)
Belt
Conveyor
Middle
Relay
(Option)

中间继电器
Middle
Relay

粉碎电机
运转灯
Grinder
Motor
Run
Lamp

报警
绿灯
Alarm
Lamp
Green

选配安全
继电器中
间继电器
(选项)
Safety
Relay
Middle
Relay
(Option)

主机延时
停机时
间继电器
(选项)
Grinder
Motor
Delay
Stoppage
Time
Relay
(Option)

机型版本 Ver E

注: 当选配皮带输送机时使用。

				制图		版号	1	标题 SG-4360(H) 控制电路图四
				设计		核准		
				校对		核准		
标记	更改前	更改后	更改人	日期	审核	日期	20220805	图号 SG-4360(H)-CE-230V-I-4
1								
2								



信易电热机械股份有限公司
Shini Plastics Technologies, Inc.

比例	第 4 张
标准	CE 共 12 张
机器电压	3Φ230V
机器频率	50Hz

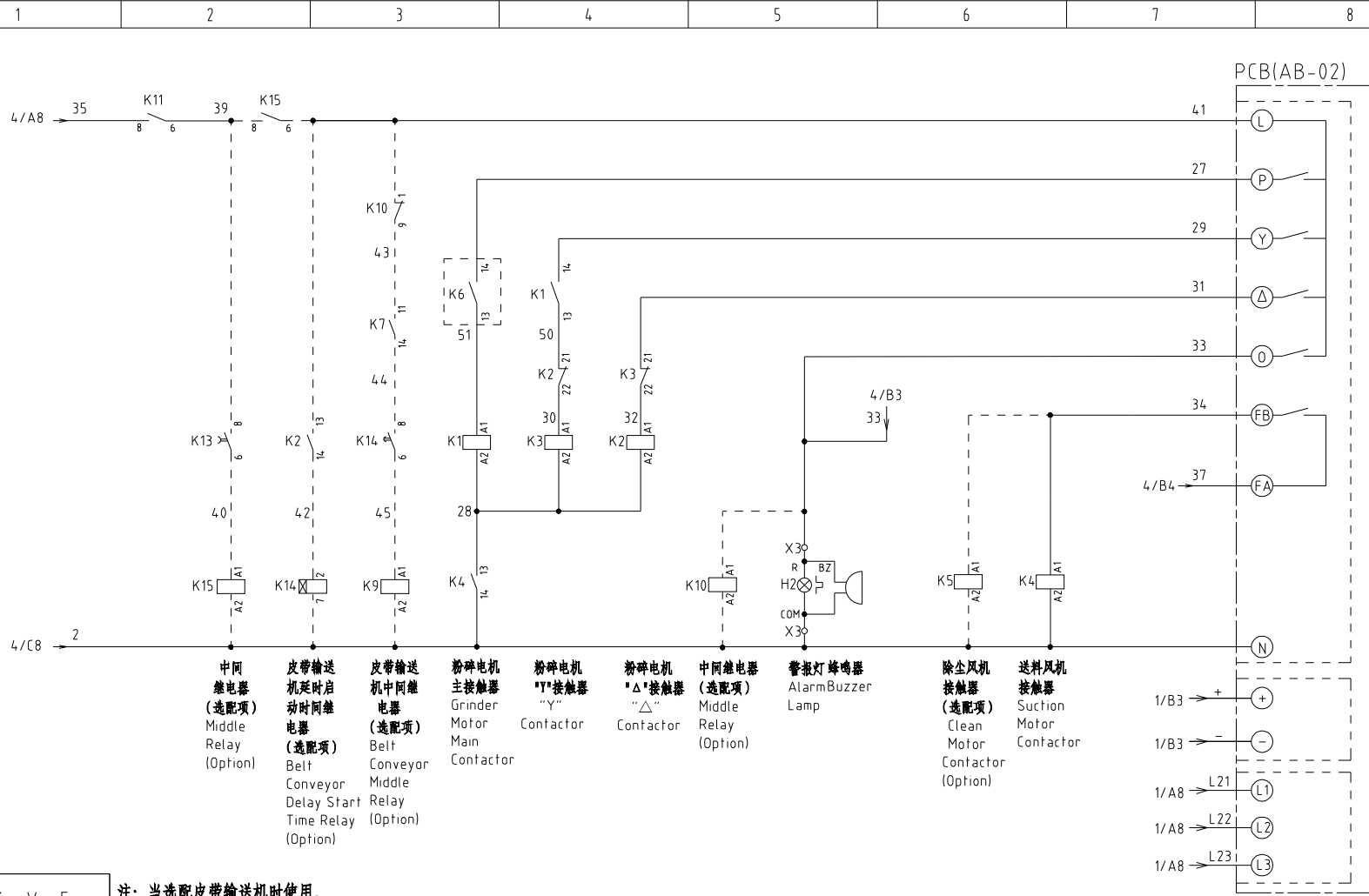

机型版本 Ver E 注: 当选配皮带输送机时使用。

制图		版号		标题		图号		比例		第 5 张	
设计		核准		SG-4360(H)		SG-4360(H)-CE-230V-I-5		标准		CE	
校对		日期		控制电路图六				机器电压		3φ230V	
审核		日期		SHINI 信易電熱機械股份有限公司		Shini Plastics Technologies, Inc.		机器频率		50Hz	
1	2	3	4	5	6	7	8				

标记	更改前	更改后	更改人	日期	审核	日期	20220805
----	-----	-----	-----	----	----	----	----------

选配皮带输送机控制触点接线示意图

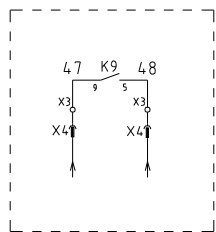

X4金属接头接线示意图
接皮带输送机
(选选项)

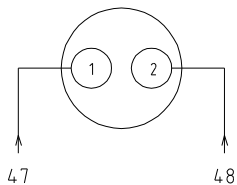

X10金属接头接线示意图
接满料报警装置
(选选项)

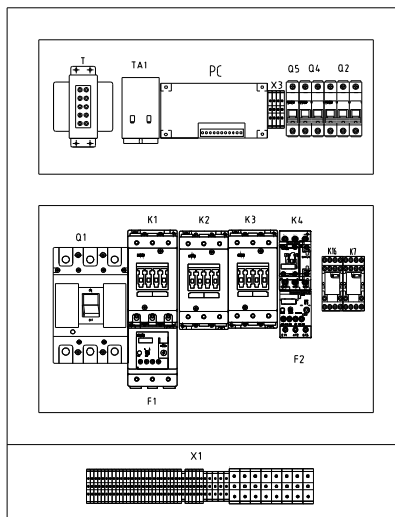
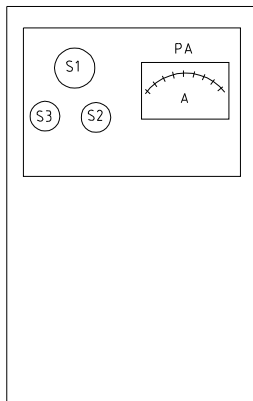
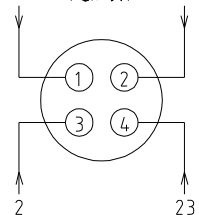

标准机型布局图

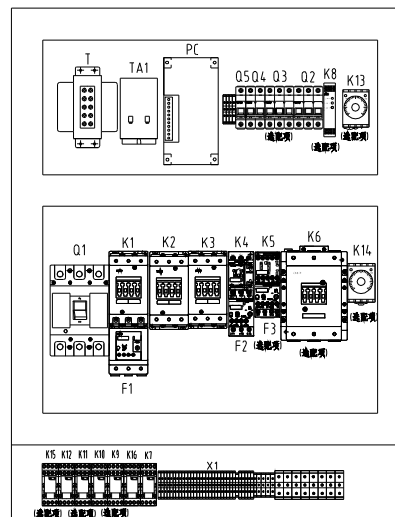

选配机型布局图

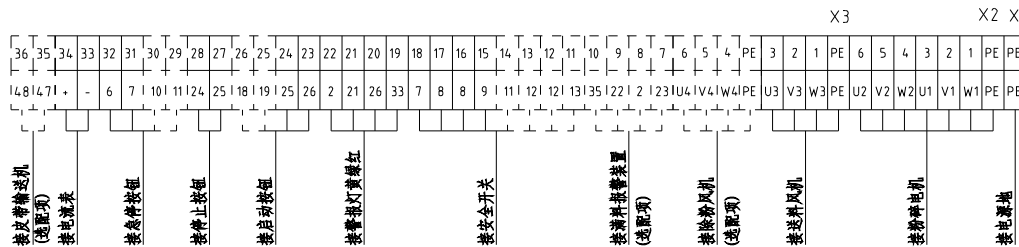

X11: 16P重载接插件

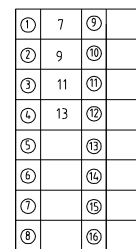

注: 当不选配安全继电器时将9号端子改为21号, 11号端子和13号端子不用接

机型版本 Ver.E 注: 当不选配安全继电器时将6号端子改为3号, 9号端子改为21号。

制图		版号		标题		图号		比例		第 6 张	
设计		核准		SG-4360(H)		SG-4360(H)-CE-230V-I-6		标准		共 12 张	
校对		日期		SHINI		信易电热机械股份有限公司		机器电压		3φ230V	
审核		日期		Shini Plastics Technologies, Inc.				机器频率		50Hz	
标记	更改前	更改后	更改人	日期	20220805						

1

2

3

4

5

6

7

8

1	2	3	4	5	6	7	8	
序号/NO	符号/Symbol	名称/Name	制造商/Manufacturer	型号/Type	规格/Specification	数量/Number	物料编号/Material number	备注/Remark
1	Q1	门连锁断路器/Gate Circuit-breaker	TECO	TAX-250L3160 3P	160A	1	YE40250300400	
2		断路器外部操作把手/External operating handle	TECO	FB1R-CS1-C-D1(TAX-250)	----	1	YE90211200300	
3	Q2	断路器/Circuit-breaker	TECO	BM-63C/3020S	20A	1	YE40302003000	
4	Q2	断路器/Circuit-breaker	TECO	BM-63C/3P	63A	1	YE40306303000	(6)
5	Q3	断路器/Circuit-breaker	TECO	BM-63C/3010S	10A	1	YE40301003000	(2)
6	Q4	断路器/Circuit-breaker	TECO	BM-63C/2006S 2P	6A	1	YE40200600000	
7	Q5	断路器/Circuit-breaker	TECO	BM-63C/1010S 1P	10A	1	YE40101000100	
8	K1,K2	接触器/Contactor	SIEMENS	3RT5045-1AC20	80A 24 VAC 50/60Hz	2	YE00504502600	
9		辅助触点/Auxiliary Contactor	SIEMENS	3RH5921-1CA01	1NC	1	YE00592110100	(4)
10		辅助触点/Auxiliary Contactor	SIEMENS	3RH5921-1CA01	1NC	1	YE00592110100	
11		辅助触点/Auxiliary Contactor	SIEMENS	3RH5921-1CA10	1NO	1	YE00592110000	(5)
12		辅助触点/Auxiliary Contactor	SIEMENS	3RH5921-1CA10	1NO	1	YE00592110000	
13	K3	接触器/Contactor	SIEMENS	3RT5044-1AC20	65A 24 VAC 50/60Hz	1	YE00504402600	
14	K4	接触器/Contactor	SIEMENS	3RT6025-1AC20	17A 24 VAC 50/60Hz	1	YE00602502600	
15	K4	接触器/Contactor	SIEMENS	3RT6028-1AC20	38A 24 VAC 50/60Hz	1	YE00602802600	(6)
16		辅助触点/Auxiliary Contactor	SIEMENS	3RH6911-1HA11	1NC+1NO	1	YE00691100100	
17	K5	接触器/Contactor	SIEMENS	3RT6016-1AB02	9A 24 VAC 50/60Hz	1	YE00601602600	(2)
18	K6	接触器/Contactor	SIEMENS	3RT5054-1AB36	115A 24 VAC 50/60Hz	1	YE00505400900	(4)
19		辅助触点/Auxiliary Contactor	SIEMENS	3RH5921-1CA01	1NC	1	YE00592110100	(4)
20		辅助触点/Subsidiary Contactor	SIEMENS	3RH5921-1CA10	1NO	1	YE00592110000	(4)
21	K7	中间继电器/Middle relay	Honeywell	GR-2C-AC24V	24 VAC	1	YE03022400300	
22	K7	中间继电器/Middle relay	Honeywell	GR-4C-AC24V	24 VAC	1	YE03042400300	(5)
23	K8	安全继电器/Safety relay	PILZ	PN0Z×2 8P	24V AC/DC	1	YE04023000000	(4)
24	T	互感变压器/Transformer	----	IN=230/200V OUT=24VAC	300VA	1	YE70023005000	
25	K9 K10 K11 K15	中间继电器/Middle relay	Honeywell	GR-2C-AC24V	24 VAC	4	YE03022400300	(5)
机型版本 Ver.E		注: (1)表示非电控箱内材料; (2)表示除尘马达选配配件; (3)表示满料报警装置选配配件; (4)表示安全继电器选配配件; (5)表示皮带输送机选配配件; (6)表示加大风机功率选配项。						
D			制图	版号	标题	图号	比例	第 7 张
			设计	核准	SG-4360	SG-4360(H)-CE-230V-I-7	标准 CE	共 12 张
			校对		 信易電熱機械股份有限公司 Shini Plastics Technologies, Inc.		机器电压	3φ230V
	标记	更改前	更改后	更改人			日期	20220805
1	2	3	4	5	6	7	8	

1	2	3	4	5	6	7	8						
序号/NO	符号/Symbol	名称/Name	制造商/Manufacturer	型号/Type	规格/Specification	数量/Number	物料编号/Material number	备注/Remark					
26	K12	中间继电器/Middle relay	Honeywell	GR-2C-AC24V	24 VAC	1	YE03022400300	(4)					
27	K13	定时器/Timer	YUYUN	TRF-N/3M	24 VAC	1	YE86032400000	(5)					
28	K14	定时器/Timer	YUYUN	TH3A-NAB 60S	24 VAC	1	YE86602400300	(5)					
29	F1	热过载继电器/Overload relay	SIEMENS	3RU5146-4 JB0	45-63A	1	YE01514640000						
30	F2	热过载继电器/Overload relay	SIEMENS	3RU6126-1JB0	7-10A	1	YE01260700000						
31	F2	热过载继电器/Overload relay	SIEMENS	3RU6126-4EB0	27-32A	1	YE01612600600	(6)					
32	F3	热过载继电器/Overload relay	SIEMENS	3RU1116-1EB0	2.8-4 A	1	YE01160280000	(2)					
33	K16	中间继电器/Middle relay	Honeywell	GR-2C-AC24V	24 VAC	1	YE03022400300						
34	S1	急停按钮/Emergency stop button	SCHNEIDER	XB2BS542C	400VAC	1	YE11254200000	(1)					
35		触点块/Contact block	SCHNEIDER	ZB2BE102C	1NC	1	YE00210203100	(1)(4)					
36	S2	停止按钮/Stop button	SCHNEIDER	XB2BA22C	400VAC	1	YE11222000000	(1)					
37	S3,H1	启动按钮(带灯)/Start button	SCHNEIDER	XB2BW33B1C	24 VAC	1	YE11233100000	(1)					
38		触点块/Contact block	SCHNEIDER	ZB2BE101C	1NO	1	YE00210103100	(1)(4)					
39	S4,S5	安全开关/Safety switch	SCHMERSRC	AZ15-02ZVRK-1476	24 VAC	2	YE16147600100	(1)					
40	S4,S5	安全开关/Safety switch	SCHMERSRC	AZ16-02ZVRK-1476	24 VAC	2	YE16147600000	(1)(4)					
41	H2	三色警报灯/Alarm lamp	SHINI	红绿黄优先顺序+蜂鸣器	24 VAC/DC 50/60Hz	1	BL90002401520	(1)					
42	H3	蜂鸣器/Buzzer	TEND	EA-2	24 VAC	1	YE84240200000	(1)(3)					
43	MS	料位马达/Feed position motor	SHINI	SR-80	24 VAC	1	YE15802400100	(1)(3)					
44	X1	端子排/Terminal	Honeywell	GK35PE	35mm ² PE	1	YE60003503500						
45	X2	端子排/Terminal	Honeywell	GK16	16mm ²	6	YE60001603200						
46			Honeywell	GK16PE	16mm ² PE	1	YE60001603500						
47	X3	端子排/Terminal	Honeywell	SK2.5	2.5mm ²	21	YE60002503200						
48			Honeywell	GK2.5PE	2.5mm ² PE	1	YE60002503400						
49			Honeywell	SK2.5	2.5mm ²	5	YE60002503200	(2)					
50			Honeywell	GK2.5PE	2.5mm ² PE	1	YE60002503400	(2)					
机型版本 Ver.E		注: (1)表示非电控箱内材料;(2)表示除尘马达选配件;(3)表示满料报警装置选配件;(4)表示安全继电器选配件;(5)表示皮带输送机选配件;(6)表示加大风机功率选配项。											
		制图		版号		标题		图号		比例		第 8 张	
		设计		核 准		SG-4360		SG-4360(H)-CE-230V-I-8		标准		CE 共 12 张	
		校对				 信易電熱機械股份有限公司 Shini Plastics Technologies, Inc.		机器电压		3φ230V			
标记		更改前		更改后				更改人		机器频率		50Hz	
日期		20220805											

1		2		3		4		5		6		7		8	
序号/NO	符号/Symbol	名称/Name		制造商/Manufacturer	型号/Type		规格/Specification		数量/Number	物料编号/Material number		备注/Remark			
51				Honeywell	SK2.5		2.5mm ²		4	YE60002503200		(3)			
52				Honeywell	SK2.5		2.5mm ²		2	YE60002503200		(5)			
53				Honeywell	SK2.5		2.5mm ²		8	YE60002503200		(4)			
54				Honeywell	SK6		6mm ²		3	YE60000603200		(6)			
55				Honeywell	SK6PE		6mm ² PE		1	YE60000603500		(6)			
56		终端固定件E/GX系列		Honeywell	----		PCS		4	YE60000003900					
57	X4	金属接头/Metal tie in		SHINI	PLT-162-RR(公)		2P		1	YE68016200100		(1)(5)			
58	X10	金属接头/Metal tie in		SHINI	PLT-254-PM		4P		1	YE68025400000		(1)(3)			
59		金属接头/Metal tie in		SHINI	PLT-254-RF		4P		1	YE68025400100		(1)(3)			
60	X11	重载接插件/Heavy duty connector		HARTING	16P+PE(公插+母座)		16P		1	YE68001601300		(1)			
61	PCB	微电脑板/PCB		YUYUN	AB-02		24VAC		1	YE80022400100					
62		塑膠外壳SI-4T線路板用		----	----		----		1	YR40000400100					
63	PA	电流表/Galvanometry		SFIM	DH-670		100/5A		1	YE25671000000		(1)			
64	TA1	电流互感器/Current mutual inductance		RATIO	RQT-10		100/5A		1	YE04100500000					
65	TA2	电流互感器/Current mutual inductance		YUYUN	----		5-100A		1	----		线路板自带			
66	M1	粉碎电机/Granulating motor		----	----		400V 50Hz 30kW		1	----		(1)			
67	M2	送料风机/Solution blower		----	----		400V 50Hz 2.2kW		1	----		(1)			
68	M2	送料风机/Solution blower		----	----		400V 50Hz 7.5kW		1	----		(1)(6)			
69	M3	除尘风机/Dust blower		----	----		400V 50Hz 0.75kW		1	----		(1)(2)			
机型版本 Ver.E		注: (1)表示非电控箱内材料; (2)表示除尘马达选配件; (3)表示满料报警装置选配件; (4)表示安全继电器选配件; (5)表示皮带输送机选配件; (6)表示加大风机功率选配项。													
制图		版号		标题		图号		比例		第 9 张					
设计		核准		SG-4360		SG-4360-CE-230V-I-9		标准		CE		共 12 张			
校对		日期		SHINI		信易電熱機械股份有限公司		机器电压		3φ230V					
标记		更改人		Shini Plastics Technologies, Inc.		机器频率		50Hz							
更改前		更改后		日期		20220805									

1		2		3		4		5		6		7		8	
序号/NO	符号/Symbol	名称/Name		制造商/Manufacturer	型号/Type		规格/Specification		数量/Number	物料编号/Material number		备注/Remark			
A	1	Q1	门连锁断路器/Gate Circuit-breaker		TECO	TAX-250L3160 3P		160A		1	YE40250300400				
	2		断路器外部操作把手/External operating handle		TECO	FB1R-CS1-C-D1(TAX-250)		----		1	YE90211200300				
	3	Q2	断路器/Circuit-breaker		TECO	BM-63C/3020S		20A		1	YE40302003000				
	4	Q2	断路器/Circuit-breaker		TECO	BM-63C/3P		63A		1	YE40306303000		(6)		
	5	Q3	断路器/Circuit-breaker		TECO	BM-63C/3010S		10A		1	YE40301003000		(2)		
	6	Q4	断路器/Circuit-breaker		TECO	BM-63C/2006S 2P		6A		1	YE40200600000				
	7	Q5	断路器/Circuit-breaker		TECO	BM-63C/1010S 1P		10A		1	YE40101000100				
B	8	K1,K2	接触器/Contactor		SIEMENS	3RT5046-1AC20		95A 24 VAC 50/60Hz		2	YE00504602600				
	9		辅助触点/Auxiliary Contactor		SIEMENS	3RH5921-1CA10		1NO		1	YE00592110000				
	10	K3	接触器/Contactor		SIEMENS	3RT5045-1AC20		80A 24 VAC 50/60Hz		1	YE00504502600				
	11		辅助触点/Auxiliary Contactor		SIEMENS	3RH5921-1CA01		1NC		2	YE00592110100				
	12		辅助触点/Auxiliary Contactor		SIEMENS	3RH5921-1CA10		1NO		1	YE00592110000		(5)		
	13		辅助触点/Auxiliary Contactor		SIEMENS	3RH5921-1CA01		1NC		1	YE00592110100		(4)		
	14	K4	接触器/Contactor		SIEMENS	3RT6025-1AC20		17A 24 VAC 50/60Hz		1	YE00602502600				
C	15	K4	接触器/Contactor		SIEMENS	3RT6028-1AC20		38A 24 VAC 50/60Hz		1	YE00602802600		(6)		
	16		辅助触点/Auxiliary Contactor		SIEMENS	3RH6911-1HA11		1NC+1NO		1	YE00691100100				
	17	K5	接触器/Contactor		SIEMENS	3RT6016-1AB02		9A 24 VAC 50/60Hz		1	YE00601602600		(2)		
	18	K6	接触器/Contactor		SIEMENS	3RT5055-6AB36		150A 24 VAC 50/60Hz		1	YE00505500600		(4)		
	19		辅助触点/Auxiliary Contactor		SIEMENS	3RH5921-1CA01		1NC		1	YE00592110100		(4)		
	20		辅助触点/Subsidiary Contactor		SIEMENS	3RH5921-1CA10		1NO		1	YE00592110000		(4)		
	21	K7	中间继电器/Middle relay		Honeywell	GR-2C-AC24V		24 VAC		1	YE03022400300				
D	22	K8	中间继电器/Middle relay		Honeywell	GR-4C-AC24V		24 VAC		1	YE03042400300		(5)		
	23	K9 K10 K11 K15	安全继电器/Safety relay		PILZ	PNOZx2 8P		24V AC/DC		1	YE04023000000		(4)		
	24	K12	中间继电器/Middle relay		Honeywell	GR-2C-AC24V		24 VAC		4	YE03022400300		(5)		
	25		中间继电器/Middle relay		Honeywell	GR-2C-AC24V		24 VAC		1	YE03022400300		(4)		
	机型版本 Ver.E		注: (1)表示非电控箱内材料; (2)表示除尘风机选配件; (3)表示满料报警装置选配件; (4)表示安全继电器选配件; (5)表示皮带输送机选配件; (6)表示加大风机功率选配件。												
				制图	版号		标题 SG-4360H		图号		比例		第 10 张		
				设计	核 准		电气元件明细一		SG-4360(H)-CE-230V-I-10		标准 CE		共 12 张		
				校对			 信易電熱機械股份有限公司 Shini Plastics Technologies, Inc.		机器电压		3φ230V				
标记		更改前		更改后		更改人			机器频率		50Hz				
1		2		3		4		5		6		7		8	

1		2		3		4		5		6		7		8	
序号/NO	符号/Symbol	名称/Name		制造商/Manufacturer	型号/Type		规格/Specification		数量/Number	物料编号/Material number		备注/Remark			
26	K13	定时器/Timer		YUYUN	TRF-N/3M		24VAC		1	YE86032400000		(5)			
27	K14	定时器/Timer		YUYUN	TH3A-NAB 60S		24VAC		1	YE86602400300		(5)			
28	F1	热过载继电器/Overload relay		SIEMENS	3RU5146-4KB0		57-75A		1	YE01514650000					
29	F2	热过载继电器/Overload relay		SIEMENS	3RU6126-1JB0		7-10A		1	YE01260700000					
30	F2	热过载继电器/Overload relay		SIEMENS	3RU6126-4EB0		27-32A		1	YE01612600600		(6)			
31	F3	热过载继电器/Overload relay		SIEMENS	3RU1116-1EB0		2.8-4A		1	YE01160280000		(2)			
32	K16	中间继电器/Middle relay		Honeywell	GR-2C-AC24V		24VAC		1	YE03022400300					
33	S1	急停按钮/Emergency stop button		SCHNEIDER	XB2BS542C		400VAC		1	YE11254200000		(1)			
34		触点块/Contact block		SCHNEIDER	ZB2BE102C		1NC		1	YE00210203100		(1)(4)			
35	S2	停止按钮/Stop button		SCHNEIDER	XB2BA22C		400VAC		1	YE11222000000		(1)			
36	S3,H1	启动按钮(带灯)/Start button		SCHNEIDER	XB2BW33B1C		24VAC		1	YE11233100000		(1)			
37		触点块/Contact block		SCHNEIDER	ZB2BE101C		1NO		1	YE00210103100		(1)(4)			
38	S4,S5	安全开关/Safety switch		SCHMERSRC	AZ16-02ZVRK-1476		230VAC		2	YE16147600000		(1)(4)			
39	S4,S5	安全开关/Safety switch		SCHMERSRC	AZ15-02ZVRK-1476		230VAC		2	YE16147600100		(1)			
40	H2	三色警报灯/Alarm lamp		SHINI	红绿黄优先顺序+蜂鸣器		24VAC/DC 50/60Hz		1	BL90002401520		(1)			
41	H3	蜂鸣器/Buzzer		TEND	EA-2		24VAC		1	YE84240200000		(1)(3)			
42	MS	料位马达/Feed position motor		SHINI	SR-80		24VAC		1	YE15802400100		(1)(3)			
43	T	互感变压器/Transformer		----	IN=230/200V OUT=24VAC		300VA		1	YE70023005000					
44	TA1	电流互感器/Current mutual inductance		RATIO	RQT-35		100/5A		1	YE04100500000					
45	PA	电流表/Galvanometry		SFIM	DH-670		100/5A		1	YE25671000000		(1)			
46	PCB	微电脑板/PCB		YUYUN	AB-02		24VAC		1	YE80022400100					
47		塑膠外壳SI-4T線路板用		----	----		----		1	YR40000400100					
48	TA2	电流互感器/Current mutual inductance		YUYUN	----		5-100A		1	----		线路板自带			
49	X1	端子排/Terminal		Honeywell	GK35PE		35mm ² PE		1	YE60003503500					
50	X2	端子排/Terminal		Honeywell	GK35		35mm ²		6	YE60003503200					
机型版本 Ver.E		注: (1)表示非电控箱内材料; (2)表示除尘风机选配件; (3)表示满料报警装置选配件; (4)表示安全继电器选配件; (5)表示皮带输送机选配件; (6)表示加大风机功率选配件。													
				制图		版号		标题 SG-4360H		图号		比例		第 11 张	
				设计		核准		电气元件明细二		SG-4360(H)-CE-230V-I-11		标准 CE		共 12 张	
				校对						信易電熱機械股份有限公司 Shini Plastics Technologies, Inc.		机器电压		3φ230V	
标记		更改前		更改后		更改人						日期		20220805	
1		2		3		4		5		6		7		8	

1		2		3		4		5		6		7		8	
序号/NO	符号/Symbol	名称/Name		制造商/Manufacturer	型号/Type		规格/Specification		数量/Number	物料编号/Material number		备注/Remark			
51		端子排/Terminal		Honeywell	GK16PE		16mm ² PE		1	YE60001603500					
52	X3	端子排/Terminal		Honeywell	SK2.5		2.5mm ²		21	YE60002503200					
53				Honeywell	GK2.5PE		2.5mm ² PE		1	YE60002503400					
54				Honeywell	SK2.5		2.5mm ²		5	YE60002503200		(2)			
55				Honeywell	GK2.5PE		2.5mm ² PE		1	YE60002503400		(2)			
56				Honeywell	SK2.5		2.5mm ²		4	YE60002503200		(3)			
57				Honeywell	SK2.5		2.5mm ²		2	YE60002503200		(5)			
58				Honeywell	SK2.5		2.5mm ²		8	YE60002503200		(4)			
59				Honeywell	SK6		6mm ²		3	YE60000603200		(6)			
60				Honeywell	SK6PE		6mm ² PE		1	YE60000603500		(6)			
61		终端固定件E/GX系列		Honeywell	----		PCS		4	YE60000003900					
62	X4	金属接头/Metal tie in		SHINI	PLT-162-RR(公)		2P		1	YE68016200100		(1)(5)			
63	X10	金属接头/Metal tie in		SHINI	PLT-254-PM		4P		1	YE68025400000		(1)(3)			
64		金属接头/Metal tie in		----	PLT-254-RF		4P		1	YE68025400100		(1)(3)			
65	X11	重载接插件/Heavy duty connector		HARTING	16P+PE(公插-母座)		16P		1	YE68001601300		(1)			
66	M1	粉碎电机/Granulating motor		----	----		400V 50Hz 37kW		1	----		(1)			
67	M2	送料风机/Solution blower		----	----		400V 50Hz 2.2kW		1	----		(1)			
68	M2	送料风机/Solution blower		----	----		400V 50Hz 7.5kW		1	----		(1)(6)			
69	M3	除尘风机/Dust blower		----	----		400V 50Hz 0.75kW		1	----		(1)(2)			
机型版本 Ver.E		注: (1)表示非电控箱内材料; (2)表示除尘风机选配件; (3)表示满料报警装置选配件; (4)表示安全继电器选配件; (5)表示皮带输送机选配件; (6)表示加大风机功率选项。													
D					制图		版号	1	标题	SG-4360H	图号		比例	第 12 张	
					设计		核		电气元件明细三	SG-4360(H)-CE-230V-I-12		标准	CE	共 12 张	
					校对		准		 信易電熱機械股份有限公司 Shini Plastics Technologies, Inc.			机器电压	3φ230V		
	标记	更改前	更改后	更改人	日期	审核	日期	20220805					机器频率	50Hz	
1		2		3		4		5		6		7		8	

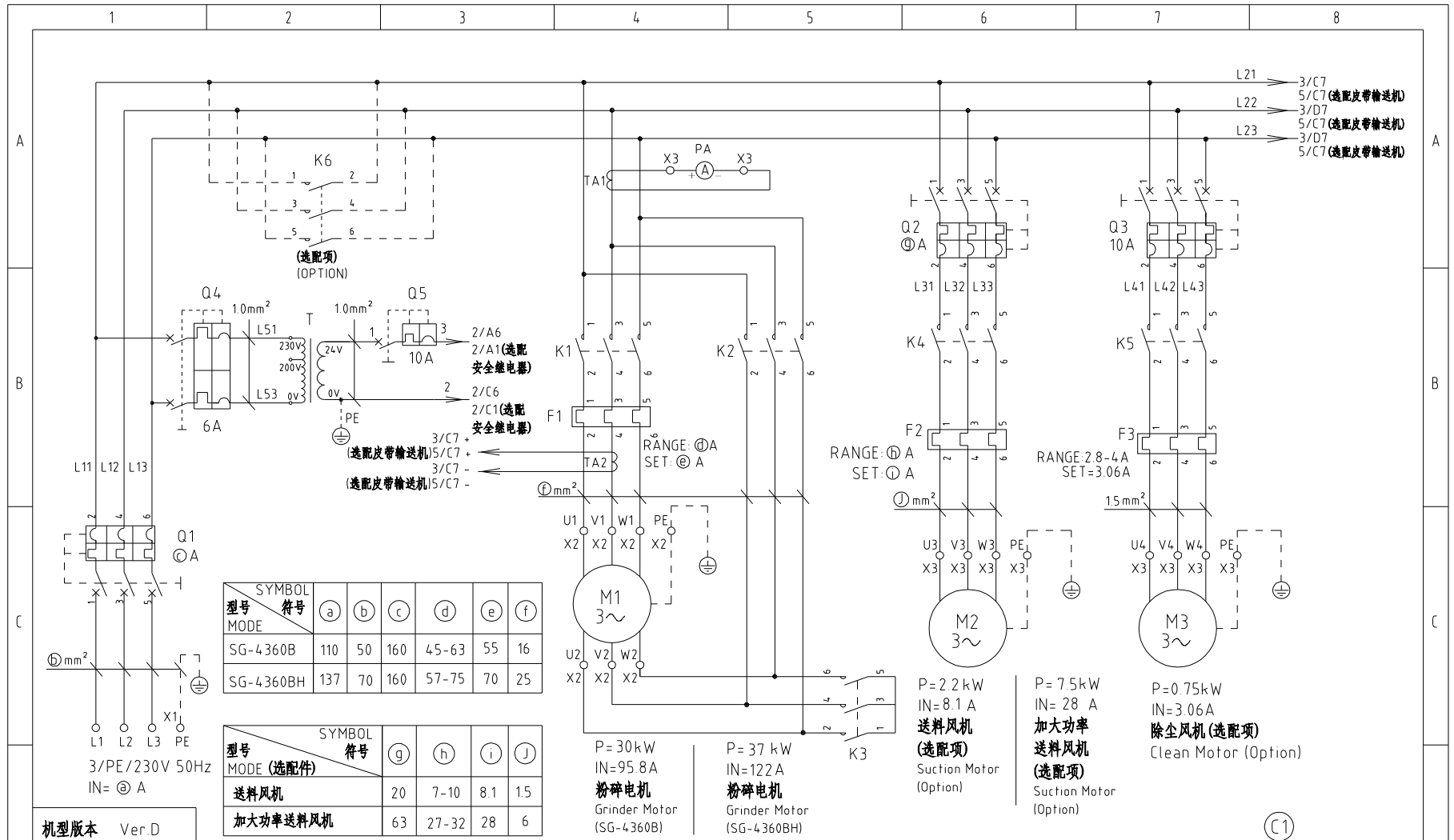

SYMBOL	符号	a	b	c	d	e	f
型号	SG-4360B	110	50	160	45-63	55	16
MODE	SG-4360BH	137	70	160	57-75	70	25

SYMBOL	符号	g	h	i	j
型号	送料风机	20	7-10	8.1	1.5
MODE (选配件)	加大功率送料风机	63	27-32	28	6

机型版本 Ver.D
3/PE/230V 50Hz
IN=⊙A

制图		版号		标题		图号		比例		第 1 张	
设计		核 准		SG-4360B(H)		SG-4360B(H)-GB-230V-C-1		标准 GB		共 12 张	
校 对		日期		SHINI		信易電熱機械股份有限公司 Shini Plastics Technologies, Inc.		机器电压		3φ230V	
更 改 前		更 改 后		日期		20220805		机器频率		50Hz	
1	2	3	4	5	6	7	8				

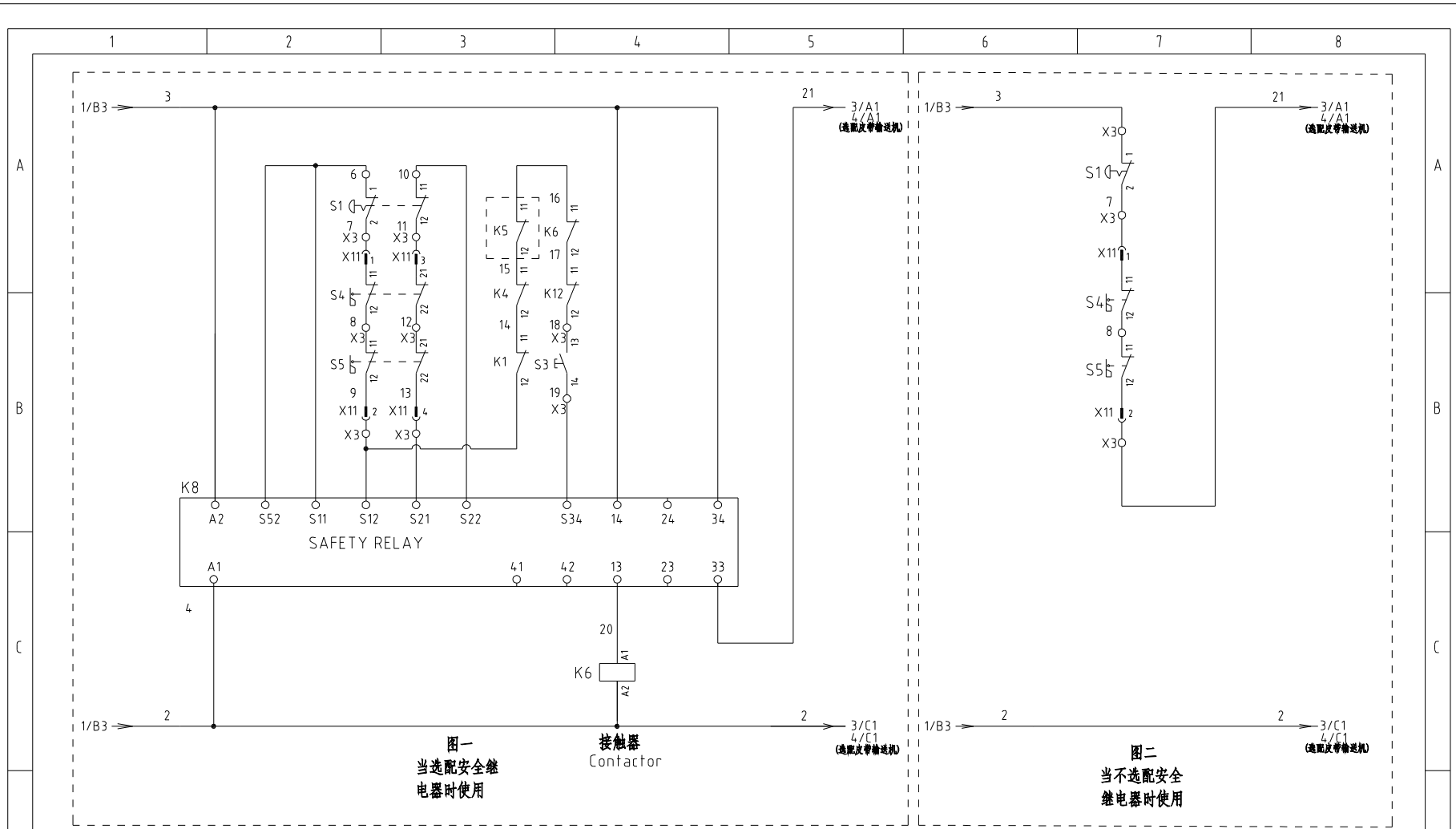

图一
当选配安全继电器时使用

图二
当不选配安全继电器时使用

机型版本 Ver.D								(C1)	
				制图		版号	C	标题	SG-4360B(H) 控制电路图一
				设计		核准		图号	SG-4360B(H)-GB-230V-C-2
(C1)	标准CE	标准GB		校对				比例	第 2 张
标记	更改前	更改后	更改人	日期	审核	日期	20220805	标准	GB 共 12 张
								机器电压	3φ230V
								机器频率	50Hz



信易電熱機械股份有限公司
Shini Plastics Technologies, Inc.

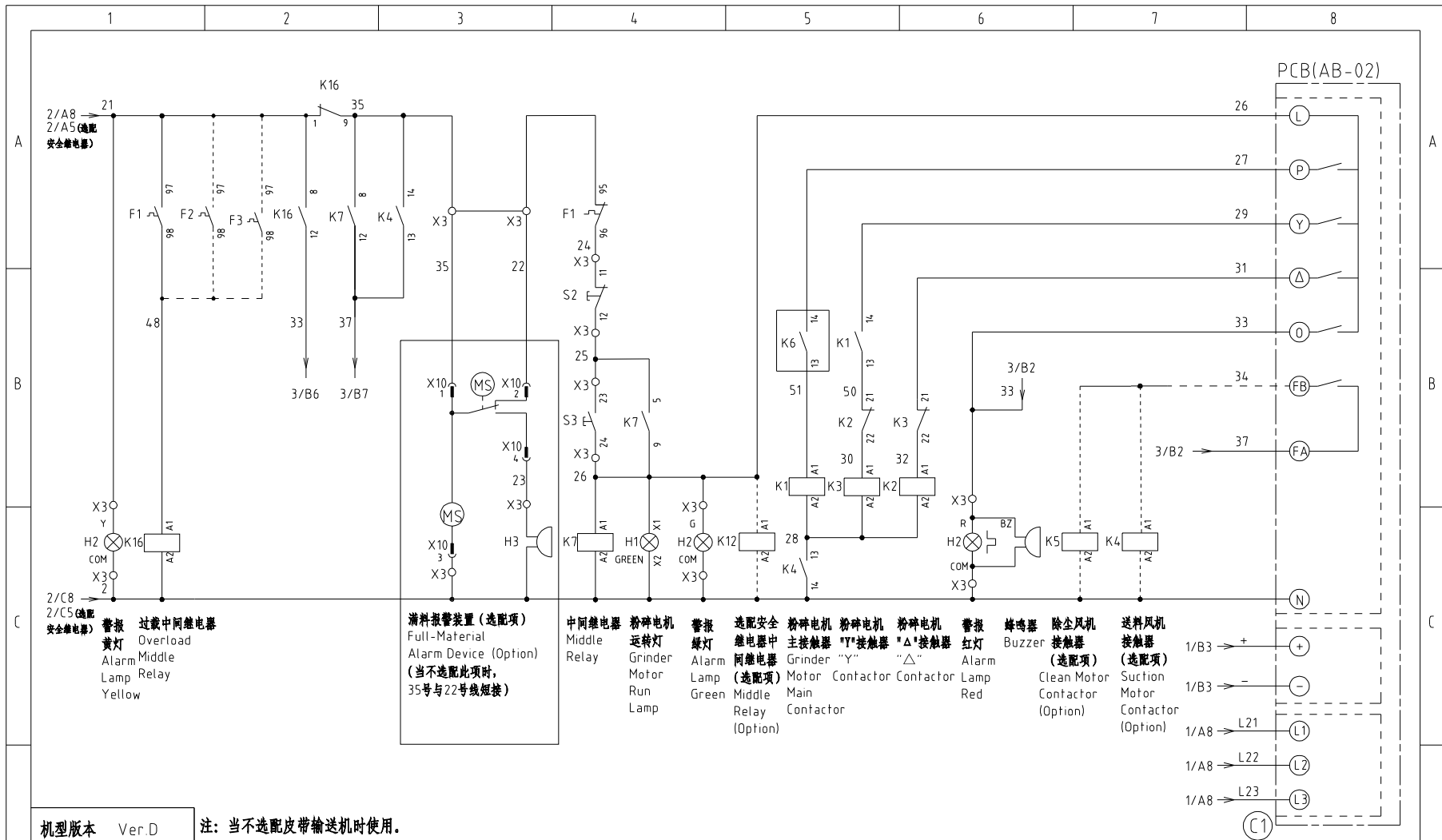

2/C8
2/C5 (选配
安全继电器)

警告 过载中间继电器
黄灯 Overload
Alarm Middle
Lamp Relay
Yellow

满料报警装置 (选选项)
Full-Material
Alarm Device (Option)
(当不选配此项时,
35号与22号线短接)

中间继电器 粉碎机
Middle Relay Grinder
Run Lamp

警告 选配安全
继电器中
间继电器
绿灯
Alarm
Middle
Relay
(Option)
Main
Contactor
(Option)

粉碎机 粉碎机 粉碎机
Grinder "Y" "△"
Contactor Contactor
Contactor

警告 蜂鸣器 除尘风机
红灯 Buzzer 接触器
Alarm Lamp Red Clean Motor
Contactor
(Option)

送料风机
接触器
(选选项)

机型版本 Ver.D 注: 当不选配皮带输送机时使用。

制图		版号		标题		图号		比例		第 3 张	
设计		核 准		SG-4360B(H)		SG-4360B(H)-GB-230V-C-2		标准 GB		共 12 张	
校 对		日期		控制电路图二				机器电压		3φ230V	
核 准		日期		SHINI 信易電熱機械股份有限公司		Shini Plastics Technologies, Inc.		机器频率		50Hz	
标记	更改前	更改后	更改人	日期	审核	日期	20220805				

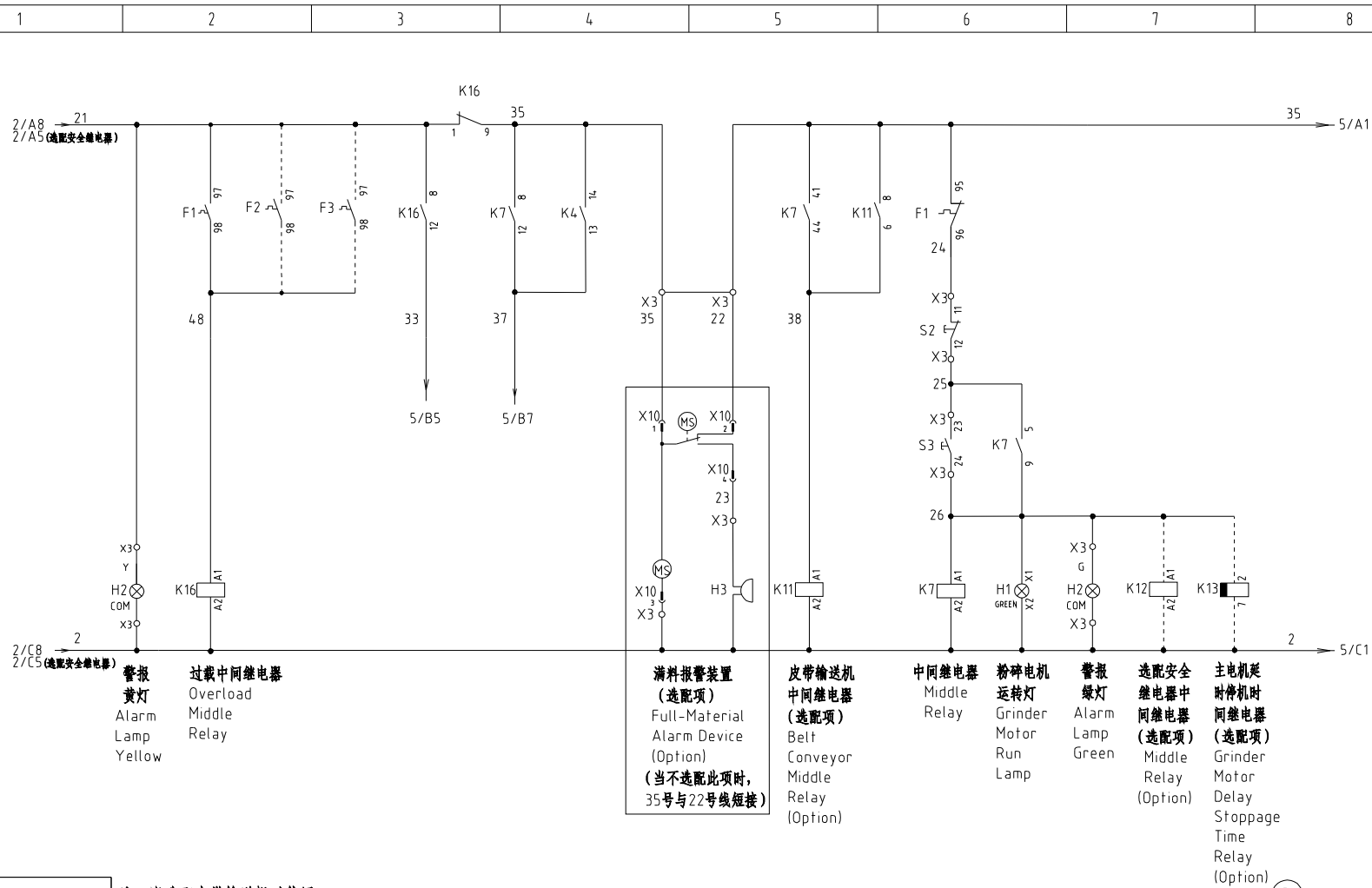

机型版本 Ver.D 注：当选配皮带输送机时使用。

D	制图	版号	C		标题	SG-4360B(H)	图号	SG-4360B(H)-GB-230V-C-2		比例	第 4 张
	设计	核准				控制电路图四			标准	GB	共 12 张
	校对	核准							机器电压	3φ230V	
标记	更改前	更改后	更改人	日期	审核	日期	20220805	 信易电热机械股份有限公司 Shini Plastics Technologies, Inc.		机器频率	50Hz
	1	2	3	4	5	6	7	8			

Ⓒ1

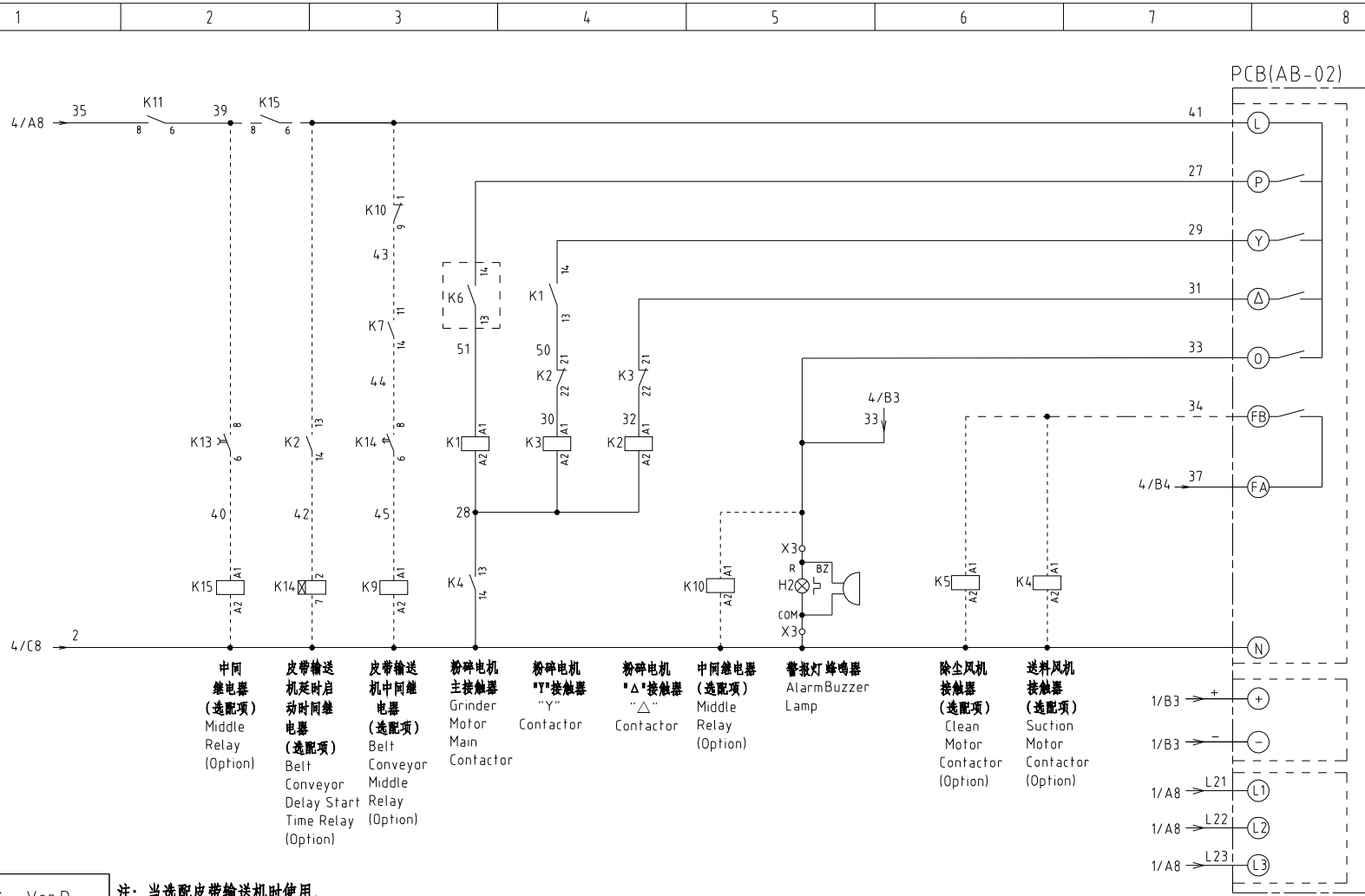

- 中间继电器 (选项项)
Middle Relay (Option)
- 皮带输送机延时启动时间继电器 (选项项)
Belt Conveyor Delay Start Time Relay (Option)
- 皮带输送机中间继电器 (选项项)
Belt Conveyor Middle Relay (Option)
- 粉碎机主接触器
Grinder Motor Main Contactor
- 粉碎机“Y”接触器
Grinder Motor “Y” Contactor
- 粉碎机“Δ”接触器
Grinder Motor “Δ” Contactor
- 中间继电器 (选项项)
Middle Relay (Option)
- 警报灯蜂鸣器
Alarm Buzzer Lamp
- 除尘风机接触器 (选项项)
Clean Motor Contactor (Option)
- 送料风机接触器 (选项项)
Suction Motor Contactor (Option)

机型版本 Ver.D		注: 当选配皮带输送机时使用。				制图		版号 C		标题 SG-4360B(H) 控制电路图六		图号 SG-4360B(H)-GB-230V-C-2		比例 C1		第 5 张	
						设计		核准				标准 GB		共 12 张			
C1		标准CE		标准GB		校对		日期 20220805		信易电热机械股份有限公司 Shini Plastics Technologies, Inc.		机器电压		3φ230V			
标记		更改前		更改后		更改人		日期				机器频率		50Hz			
1		2		3		4		5		6		7		8			

选配皮带输送机控制触点接线示意图

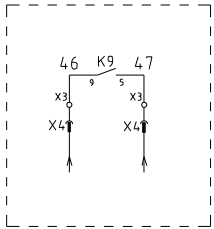

X4 金属接头接线示意图
接皮带输送机
(选选项)

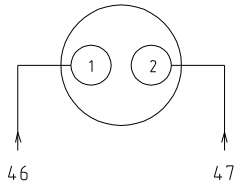

X10 金属接头接线示意图
接满料报警装置
(选选项)

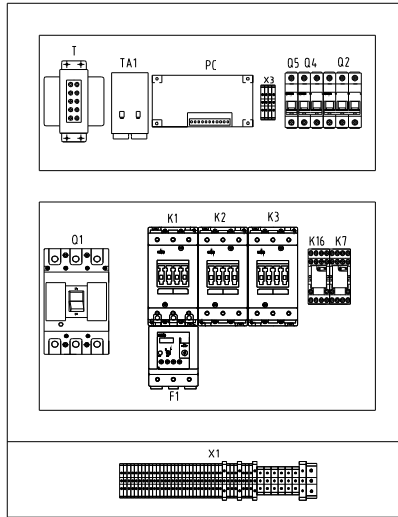
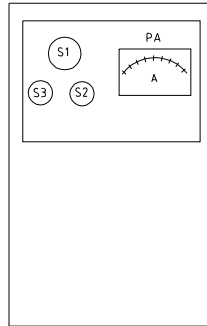
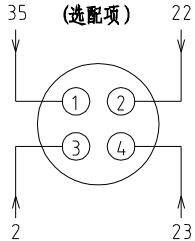

标准机型布局图

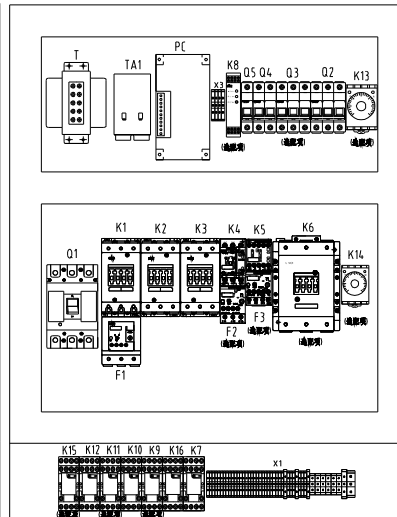

选配机型布局图

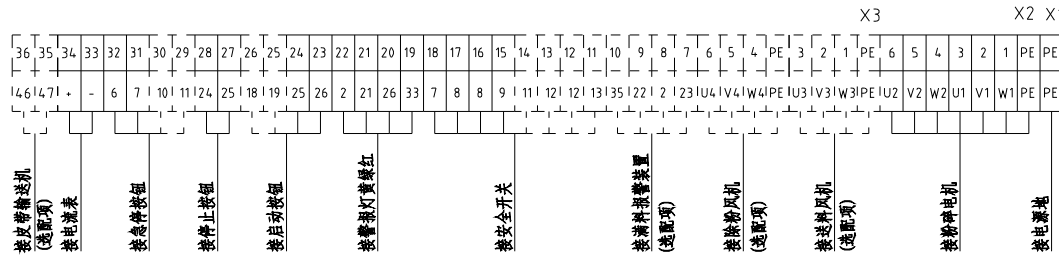

X11: 16P 重载接插件

①	7	⑨	
②	9	⑩	
③	11	⑪	
④	13	⑫	
⑤		⑬	
⑥		⑭	
⑦		⑮	
⑧		⑯	

注: 当不选配安全继电器时将9号端子改为21号, 11号端子和13号端子不用接

机型版本 Ver.D 注: 当不选配安全继电器时将6号端子改为3号, 9号端子改为21号。

制图		版号		标题		图号		比例		第 6 张	
设计		核 准		SG-4360B(H)		SG-4360B(H)-GB-230V-C-2		标准 GB		共 12 张	
校 对		日 期		电 气 元 件 布 置 图		信 易 电 热 机 械 股 份 有 限 公 司		机 器 电 压		3φ230V	
审 核		20220805		SHINI		Shini Plastics Technologies, Inc.		机 器 频 率		50Hz	
标记	更改前	更改后	更改人	日期	审核	日期					

1		2		3		4		5		6		7		8	
序号/NO	符号/Symbol	名称/Name		制造商/Manufacturer	型号/Type		规格/Specification		数量/Number	物料编号/Material number		备注/Remark			
A	1	Q1	门连锁断路器/Gate Circuit-breaker		TECO	TAX-250L3160 3P		160A		1	YE40250300400				
	2		断路器外部操作把手/External operating handle		TECO	FB1R-CS1-C-D1(TAX-250)		----		1	YE90211200300				
	3	Q2	断路器/Circuit-breaker		TECO	BM-63C/3020S		20A		1	YE40302003000		(7)		
	4	Q2	断路器/Circuit-breaker		TECO	BM-63C/3P		63A		1	YE40306303000		(6)		
	5	Q3	断路器/Circuit-breaker		TECO	BM-63C/3010S		10A		1	YE40301003000		(2)		
	6	Q4	断路器/Circuit-breaker		TECO	BM-63C/2006S 2P		6A		1	YE40200600000				
	7	Q5	断路器/Circuit-breaker		TECO	BM-63C/1010S 1P		10A		1	YE40101000100				
B	8	K1,K2	接触器/Contactor		SIEMENS	3RT5045-1AC20		80A 24 VAC 50/60Hz		2	YE00504502600				
	9		辅助触点/Auxiliary Contactor		SIEMENS	3RH5921-1CA01		1NC		1	YE00592110100		(4)		
	10		辅助触点/Auxiliary Contactor		SIEMENS	3RH5921-1CA01		1NC		1	YE00592110100				
	11		辅助触点/Auxiliary Contactor		SIEMENS	3RH5921-1CA10		1NO		1	YE00592110000		(5)		
	12		辅助触点/Auxiliary Contactor		SIEMENS	3RH5921-1CA10		1NO		1	YE00592110000				
	13	K3	接触器/Contactor		SIEMENS	3RT5044-1AC20		65A 24 VAC 50/60Hz		1	YE00504402600				
	14	K4	接触器/Contactor		SIEMENS	3RT6017-1AB01		12A 24 VAC 50/60Hz		1	YE00601702500		(7)		
C	15	K4	接触器/Contactor		SIEMENS	3RT6028-1AC20		38A 24 VAC 50/60Hz		1	YE00602802600		(6)		
	16		辅助触点/Auxiliary Contactor		SIEMENS	3RH6911-1HA11		1NC+1NO		1	YE00691100100				
	17	K5	接触器/Contactor		SIEMENS	3RT6016-1AB02		9A 24 VAC 50/60Hz		1	YE00601602600		(2)		
	18	K6	接触器/Contactor		SIEMENS	3RT5054-1AB36		115A 24 VAC 50/60Hz		1	YE00505400900		(4)		
	19		辅助触点/Auxiliary Contactor		SIEMENS	3RH5921-1CA01		1NC		1	YE00592110100		(4)		
	20		辅助触点/Subsidiary Contactor		SIEMENS	3RH5921-1CA10		1NO		1	YE00592110000		(4)		
	21	K7	中间继电器/Middle relay		Honeywell	GR-2C-AC24V		24 VAC		1	YE03022400300				
D	22	K7	中间继电器/Middle relay		Honeywell	GR-4C-AC24V		24 VAC		1	YE03042400300		(5)		
	23	K8	安全继电器/Safety relay		PILZ	PNOZ×2 8P		24V AC/DC		1	YE04023000000		(4)		
	24	T	互感器/Transformer		----	IN=230/200V OUT=24VAC		300VA		1	YE70023005000				
	25	K9 K10 K11 K15	中间继电器/Middle relay		Honeywell	GR-2C-AC24V		24 VAC		4	YE03022400300		(5)		
机型版本 Ver.D 注: (1)表示非电控箱内材料; (2)表示除尘马达选配件; (3)表示满料报警装置选配件; (4)表示安全继电器选配件; (5)表示皮带输送机选配件; (6)表示加大风机功率选配件; (7)表示送料风机选配件。 (C1)															
				制图	版号 C		标题 SG-4360B		图号 SG-4360B(H)-GB-230V-C-2		比例	第 7 张			
				设计	核准		电气元件明细一				标准 GB	共 12 张			
(C1)		标准CE	标准GB	校对	核准		 信易電熱機械股份有限公司 Shini Plastics Technologies, Inc.		机器电压		3φ230V				
标记 更改前		更改后	更改人	日期	审核	日期			20220805	机器频率		50Hz			
1		2		3		4		5		6		7		8	

1	2	3	4	5	6	7	8	
序号/NO	符号/Symbol	名称/Name	制造商/Manufacturer	型号/Type	规格/Specification	数量/Number	物料编号/Material number	备注/Remark
26	K12	中间继电器/Middle relay	Honeywell	GR-2C-AC24V	24VAC	1	YE03022400300	(4)
27	K13	定时器/Timer	YUYUN	TRF-N/3M	24VAC	1	YE86032400000	(5)
28	K14	定时器/Timer	YUYUN	TH3A-NAB 60S	24VAC	1	YE86602400300	(5)
29	F1	热过载继电器/Overload relay	SIEMENS	3RU5146-4JB0	45-63A	1	YE01514640000	
30	F2	热过载继电器/Overload relay	SIEMENS	3RU6116-1JB0	7-10A	1	YE01167100000	(7)
31	F2	热过载继电器/Overload relay	SIEMENS	3RU6126-4EB0	27-32A	1	YE01612600600	(6)
32	F3	热过载继电器/Overload relay	SIEMENS	3RU1116-1EB0	2.8-4A	1	YE01160280000	(2)
33	K16	中间继电器/Middle relay	Honeywell	GR-2C-AC24V	24VAC	1	YE03022400300	
34	S1	急停按钮/Emergency stop button	SCHNEIDER	XB2BS542C	400VAC	1	YE11254200000	(1)
35		触点块/Contact block	SCHNEIDER	ZB2BE102C	1NC	1	YE00210203100	(1)(4)
36	S2	停止按钮/Stop button	SCHNEIDER	XB2BA22C	400VAC	1	YE11222000000	(1)
37	S3,H1	启动按钮(带灯)/Start button	SCHNEIDER	XB2BW33B1C	24VAC	1	YE11233100000	(1)
38		触点块/Contact block	SCHNEIDER	ZB2BE101C	1NO	1	YE00210103100	(1)(4)
39	S4,S5	安全开关/Safety switch	SCHMERSRC	AZ15-02ZVRK-1476	24VAC	2	YE16147600100	(1)
40	S4,S5	安全开关/Safety switch	SCHMERSRC	AZ16-02ZVRK-1476	24VAC	2	YE16147600000	(1)(4)
41	H2	三色警报灯/Alarm lamp	SHINI	红黄绿优先顺序+蜂鸣器	24VAC/DC 50/60Hz	1	BL90002401520	(1)
42	H3	蜂鸣器/Buzzer	TEND	EA-2	24VAC	1	YE84240200000	(1)(3)
43	MS	料位马达/Feed position motor	SHINI	SR-80	24VAC	1	YE15802400100	(1)(3)
44	X1	端子排/Terminal	Honeywell	GK35PE	35mm ² PE	1	YE60003503500	
45	X2	端子排/Terminal	Honeywell	GK16	16mm ²	6	YE60001603200	
46		端子排/Terminal	Honeywell	GK16PE	16mm ² PE	1	YE60001603500	
47	X3	端子排/Terminal	Honeywell	SK2 5	2.5mm ²	21	YE60002503200	
48			Honeywell	GK2 5PE	2.5mm ² PE	1	YE60002503400	
49			Honeywell	SK2 5	2.5mm ² PE	5	YE60002503200	(2)
50			Honeywell	GK2 5PE	2.5mm ² PE	1	YE60002503400	(2)
机型版本 Ver.D		注: (1)表示非电控箱内材料; (2)表示除尘马达选配件; (3)表示满料报警装置选配件; (4)表示安全继电器选配件; (5)表示皮带输送机选配件; (6)表示加大风机功率选配项; (7)表示送料风机选配件。						(C1)
		制图		版本号	标题	图号	比例	第 8 张
		设计		核 准	SG-4360B	SG-4360B(H)-GB-230V-C-2	标准 GB	共 12 张
(C1)		标准CE	标准GB	校 对	 信易電熱機械股份有限公司 Shini Plastics Technologies, Inc.		机器电压	3φ230V
标记		更改前	更改后	更改人			日期	20220805
1	2	3	4	5	6	7	8	

1	2	3	4	5	6	7	8					
序号/NO	符号/Symbol	名称/Name	制造商/Manufacturer	型号/Type	规格/Specification	数量/Number	物料编号/Material number	备注/Remark				
51			Honeywell	SK2.5	2.5mm ²	4	YE60002503200	(3)				
52			Honeywell	SK2.5	2.5mm ²	2	YE60002503200	(5)				
53			Honeywell	SK2.5	2.5mm ²	8	YE60002503200	(4)				
54			Honeywell	SK6	6mm ²	3	YE60000603200	(6)				
55			Honeywell	SK6PE	6mm ² PE	1	YE60000603500	(6)				
56		终端固定件B/GE系列	Honeywell	----	PCS	4	YE60000003900					
57	X4	金属接头/Metal tie in	SHINI	PLT-162-RR(公)	2P	1	YE68016200100	(1)(5)				
58	X10	金属接头/Metal tie in	SHINI	PLT-254-PM	4P	1	YE68025400000	(1)(3)				
59		金属接头/Metal tie in	SHINI	PLT-254-RF	4P	1	YE68025400100	(1)(3)				
60	X11	重载接插件/Heavy duty connector	HARTING	16P+PE(公插-母座)	16P	1	YE68001601300	(1)				
61	PCB	微电脑板/PCB	YUYUN	AB-02	24VAC	1	YE80022400100					
62		塑膠外壳SI-4T線路板用	----	----	----	1	YR40000400100					
63	PA	电流表/Galvanometry	SFIM	DH-670	100/5A	1	YE25671000000	(1)				
64	TA1	电流互感器/Current mutual inductance	RATIO	RQT-10	100/5A	1	YE04100500000					
65	TA2	电流互感器/Current mutual inductance	YUYUN	----	5-100A	1	----	线路板自带				
66	M1	粉碎电机/Granulating motor	----	----	400V 50Hz 30kW	1	----	(1)				
67	M2	送料风机/Solution blower	----	----	400V 50Hz 2.2kW	1	----	(1)				
68	M2	送料风机/Solution blower	----	----	400V 50Hz 7.5kW	1	----	(1)(6)				
69	M3	除尘风机/Dust blower	----	----	400V 50Hz 0.75kW	1	----	(1)(2)				
机型版本 Ver.D 注: (1)表示非电控箱内材料; (2)表示除尘马达选配件; (3)表示满料报警装置选配件; (4)表示安全继电器选配件; (5)表示皮带输送机选配件; (6)表示加大风机功率选配件; (7)表示送料风机选配件。 (C1)												
制图			版号		标题		图号		比例		第 9 张	
设计			核 准		SG-4360B		SG-4360B(H)-GB-230V-C-2		标准		GB 共 12 张	
校 对			核 准		 信易電熱機械股份有限公司 Shini Plastics Technologies, Inc.		机器电压		3φ230V			
标 记			日期				20220805		机器频率		50Hz	
1	2	3	4	5	6	7	8					

1		2		3		4		5		6		7		8	
序号/NO	符号/Symbol	名称/Name		制造商/Manufacturer		型号/Type		规格/Specification		数量/Number	物料编号/Material number		备注/Remark		
A	1	Q1	门连锁断路器/Gate Circuit-breaker		TECO		TAX-250L3160 3P		160A		1	YE40250300400			
	2		断路器外部操作把手/External operating handle		TECO		FB1R-CS1-C-D1(TAX-250)		----		1	YE90211200300			
	3	Q2	断路器/Circuit-breaker		TECO		BM-63C/3020S		20A		1	YE40302003000		(7)	
	4	Q2	断路器/Circuit-breaker		TECO		BM-63C/3P		63A		1	YE40306303000		(6)	
	5	Q3	断路器/Circuit-breaker		TECO		BM-63C/3P		6A		1	YE40300603000		(2)	
	6	Q4	断路器/Circuit-breaker		TECO		BM-63C/2006S 2P		6A		1	YE40200600000			
	7	Q5	断路器/Circuit-breaker		TECO		BM-63C/1010S 1P		10A		1	YE40101000100			
B	8	K1,K2	接触器/Contactor		SIEMENS		3RT5046-1AC20		95A 24 VAC 50/60Hz		2	YE00504602600			
	9		辅助触点/Auxiliary Contactor		SIEMENS		3RH5921-1CA10		1NO		1	YE00592110000			
	10	K3	接触器/Contactor		SIEMENS		3RT5045-1AC20		80A 24 VAC 50/60Hz		1	YE00504502600			
	11		辅助触点/Auxiliary Contactor		SIEMENS		3RH5921-1CA01		1NC		2	YE00592110100			
	12		辅助触点/Auxiliary Contactor		SIEMENS		3RH5921-1CA10		1NO		1	YE00592110000		(5)	
	13		辅助触点/Auxiliary Contactor		SIEMENS		3RH5921-1CA01		1NC		1	YE00592110100		(4)	
	14	K4	接触器/Contactor		SIEMENS		3RT6017-1AB01		12A 24 VAC 50/60Hz		1	YE00601702500		(7)	
C	15	K4	接触器/Contactor		SIEMENS		3RT6028-1AC20		38A 24 VAC 50/60Hz		1	YE00602802600		(6)	
	16		辅助触点/Auxiliary Contactor		SIEMENS		3RH6911-1HA11		1NC+1NO		1	YE00691100100			
	17	K5	接触器/Contactor		SIEMENS		3RT6016-1AB02		9A 24 VAC 50/60Hz		1	YE00601602600		(2)	
	18	K6	接触器/Contactor		SIEMENS		3RT5055-6AB36		150A 24 VAC 50/60Hz		1	YE00505500600		(4)	
	19		辅助触点/Auxiliary Contactor		SIEMENS		3RH5921-1CA01		1NC		1	YE00592110100		(4)	
	20		辅助触点/Subsidiary Contactor		SIEMENS		3RH5921-1CA10		1NO		1	YE00592110000		(4)	
	21	K7	中间继电器/Middle relay		Honeywell		GR-2C-AC24V		24 VAC		1	YE03022400300			
D	22	K7	中间继电器/Middle relay		Honeywell		GR-4C-AC24V		24 VAC		1	YE03042400300		(5)	
	23	K8	安全继电器/Safety relay		PILZ		PNOZ×2.8P		24V AC/DC		1	YE04023000000		(4)	
	24	K9 K10 K11 K15	中间继电器/Middle relay		Honeywell		GR-2C-AC24V		24 VAC		4	YE03022400300		(5)	
	25	K12	中间继电器/Middle relay		Honeywell		GR-2C-AC24V		24 VAC		1	YE03022400300		(4)	
	机型版本 Ver.D		注: (1)表示非电控箱内材料; (2)表示除尘风机选配件; (3)表示满料报警装置选配件; (4)表示安全继电器选配件; (5)表示皮带输送机选配件; (6)表示加大风机功率选配件; (7)表示送料风机选配件。												
				制图		版号 C		标题 SG-4360BH		图号 SG-4360B(H)-GB-230V-C-10		比例 (C1)		第 10 张	
				设计		核准		电气元件明细一				标准 GB		共 12 张	
(C1)		标准CE		标准GB		校对		 信易電熱機械股份有限公司 Shini Plastics Technologies, Inc.		机器电压		3φ230V			
标记 更改前		更改后		更改人		日期				20220805		机器频率		50Hz	
1		2		3		4		5		6		7		8	

1		2		3		4		5		6		7		8	
序号/NO	符号/Symbol	名称/Name		制造商/Manufacturer	型号/Type		规格/Specification		数量/Number	物料编号/Material number		备注/Remark			
26	K13	定时器/Timer		YUYUN	TRF-N/3M		24VAC		1	YE86032400000		(5)			
27	K14	定时器/Timer		YUYUN	TH3A-NAB 60S		24VAC		1	YE86602400300		(5)			
28	F1	热过载继电器/Overload relay		SIEMENS	3RU5146-4KB0		57-75A		1	YE01514650000					
29	F2	热过载继电器/Overload relay		SIEMENS	3RU6116-1JB0		7-10A		1	YE01167100000		(7)			
30	F2	热过载继电器/Overload relay		SIEMENS	3RU6126-4EB0		27-32A		1	YE01612600600		(6)			
31	F3	热过载继电器/Overload relay		SIEMENS	3RU1116-1EB0		2.8-4A		1	YE01160280000		(2)			
32	K16	中间继电器/Middle relay		Honeywell	GR-2C-AC24V		24VAC		1	YE03022400300					
33	S1	急停按钮/Emergency stop button		SCHNEIDER	XB2BS542C		400VAC		1	YE11254200000		(1)			
34		触点块/Contact block		SCHNEIDER	ZB2BE102C		1NC		1	YE00210203100		(1)(4)			
35	S2	停止按钮/Stop button		SCHNEIDER	XB2BA22C		400VAC		1	YE11222000000		(1)			
36	S3,H1	启动按钮(带灯)/Start button		SCHNEIDER	XB2BW33B1C		24VAC		1	YE11233100000		(1)			
37		触点块/Contact block		SCHNEIDER	ZB2BE101C		1NO		1	YE00210103100		(1)(4)			
38	S4,S5	安全开关/Safety switch		SCHMERSRC	AZ16-02ZVRK-1476		230VAC		2	YE16147600000		(1)(4)			
39	S4,S5	安全开关/Safety switch		SCHMERSRC	AZ15-02ZVRK-1476		230VAC		2	YE16147600100		(1)			
40	H2	三色警报灯/Alarm lamp		SHINI	红绿黄优先顺序+蜂鸣器		24VAC/DC 50/60Hz		1	BL90002401520		(1)			
41	H3	蜂鸣器/Buzzer		TEND	EA-2		24VAC		1	YE84240200000		(1)(3)			
42	MS	料位马达/Feed position motor		SHINI	SR-80		24VAC		1	YE15802400100		(1)(3)			
43	T	互感变压器/Transformer		----	IN=230/200V OUT=24VAC		300VA		1	YE70023005000					
44	TA1	电流互感器/Current mutual inductance		RATIO	RQT-35		100/5A		1	YE04100500000					
45	PA	电流表/Galvanometry		SFIM	DH-670		100/5A		1	YE25671000000		(1)			
46	PCB	微电脑板/PCB		YUYUN	AB-02		24VAC		1	YE80022400100					
47		塑膠外殼SI-4T線路板用		----	----		----		1	YR40000400100					
48	TA2	电流互感器/Current mutual inductance		YUYUN	----		5-100A		1	----		线路板自带			
49	X1	端子排/Terminal		Honeywell	GK35PE		35mm ² PE		1	YE60003503500					
50	X2	端子排/Terminal		Honeywell	GK35		35mm ²		6	YE60003503200					
机型版本 Ver.D		注: (1)表示非电控箱内材料;(2)表示除尘风机选配件;(3)表示满料报警装置选配件;(4)表示安全继电器选配件;(5)表示皮带输送机选配件;(6)表示加大风机功率选配件;(7)表示送料风机选配件。													
D					制图		版号	C	标题	SG-4360BH	图号	比例 $\frac{1}{1}$		第 11 张	
					设计		核准		电气元件明细二	SG-4360B(H)-GB-230V-C-11		标准	GB	共 12 张	
	$\text{\textcircled{C1}}$	标准CE	标准GB		校对					信易電熱機械股份有限公司		机器电压	3 ϕ 230V		
	标记	更改前	更改后	更改人	日期	审核	日期	20220805		Shini Plastics Technologies, Inc.		机器频率	50Hz		
1		2		3		4		5		6		7		8	

1	2	3	4	5	6	7	8	
序号/NO	符号/Symbol	名称/Name	制造商/Manufacturer	型号/Type	规格/Specification	数量/Number	物料编号/Material number	备注/Remark
51		端子排/Terminal	Honeywell	GK16PE	16mm ² PE	1	YE60001603500	
52	X3	端子排/Terminal	Honeywell	SK2.5	2.5mm ²	21	YE60002503200	
53			Honeywell	GK2.5PE	2.5mm ² PE	1	YE60002503400	
54			Honeywell	SK2.5	2.5mm ²	5	YE60002503200	(2)
55			Honeywell	GK2.5PE	2.5mm ² PE	1	YE60002503400	(2)
56			Honeywell	SK2.5	2.5mm ²	4	YE60002503200	(3)
57			Honeywell	SK2.5	2.5mm ²	2	YE60002503200	(5)
58			Honeywell	SK2.5	2.5mm ²	8	YE60002503200	(4)
59			Honeywell	SK6	6mm ²	3	YE60000603200	(6)
60			Honeywell	SK6PE	6mm ² PE	1	YE60000603500	(6)
61		终端固定件B/GK系列	Honeywell		PCS	4	YE60000003900	
62	X4	金属接头/Metal tie in	SHINI	PLT-162-RR(公)	2P	1	YE68016200100	(1)(5)
63	X10	金属接头/Metal tie in	SHINI	PLT-254-PM	4P	1	YE68025400000	(1)(3)
64		金属接头/Metal tie in	----	PLT-254-RF	4P	1	YE68025400100	(1)(3)
65	X11	重载接插件/Heavy duty connector	HARTING	16P+PE(公插-母座)	16P	1	YE68001601300	(1)
66	M1	粉碎电机/Granulating motor	----	----	400V 50Hz 37kW	1	----	(1)
67	M2	送料风机/Solution blower	----	----	400V 50Hz 2.2kW	1	----	(1)
68	M2	送料风机/Solution blower	----	----	400V 50Hz 7.5kW	1	----	(1)(6)
69	M3	除尘风机/Dust blower	----	----	400V 50Hz 0.75kW	1	----	(1)(2)
机型版本 Ver.D		注: (1)表示非电控箱内材料; (2)表示除尘风机选配件; (3)表示满料报警装置选配件; (4)表示安全继电器选配件; (5)表示皮带输送机选配件; (6)表示加大风机功率选配件; (7)表示送料风机选配件。						
			制图	版号 C	标题 SG-4360BH	图号 SG-4360B(H)-GB-230V-C-12	比例 $\frac{1}{1}$	第 12 张
			设计	核准	电气元件明细三		标准 GB	共 12 张
$\text{\textcircled{C}}$	标准CE	标准GB	校对	核准	 信易電熱機械股份有限公司 Shini Plastics Technologies, Inc.		机器电压	3 ϕ 230V
标记	更改前	更改后	更改人	日期			20220805	机器频率

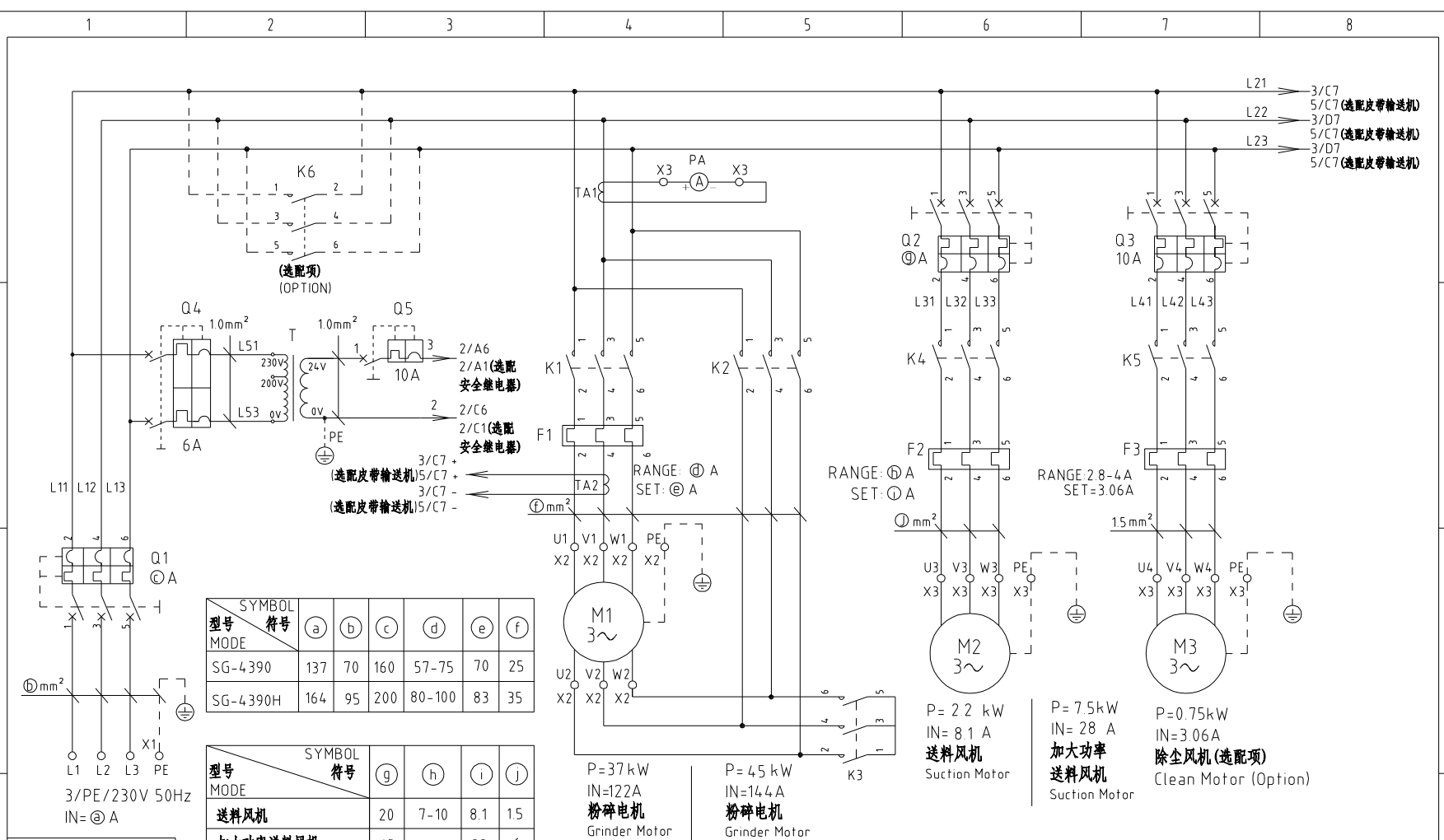

SYMBOL		符号					
型号	MODE	(a)	(b)	(c)	(d)	(e)	(f)
SG-4390		137	70	160	57-75	70	25
SG-4390H		164	95	200	80-100	83	35

SYMBOL		符号			
型号	MODE	(g)	(h)	(i)	(j)
送料风机		20	7-10	8.1	15
加大功率送料风机		63	27-32	28	6

机型版本 Ver.E

制图	版号	J					
设计	核准						
校对	核准						
标记	更改前	更改后	更改人	日期	审核	日期	20220805

标题 SG-4390(H)
主电路图

图号 SG-4390(H)-CE-230V-J-1

比例 第 1 张
标准 CE 共 12 张



信易電熱機械股份有限公司
Shini Plastics Technologies, Inc.

机器电压 3φ230V
机器频率 50Hz

1 2 3 4 5 6 7 8

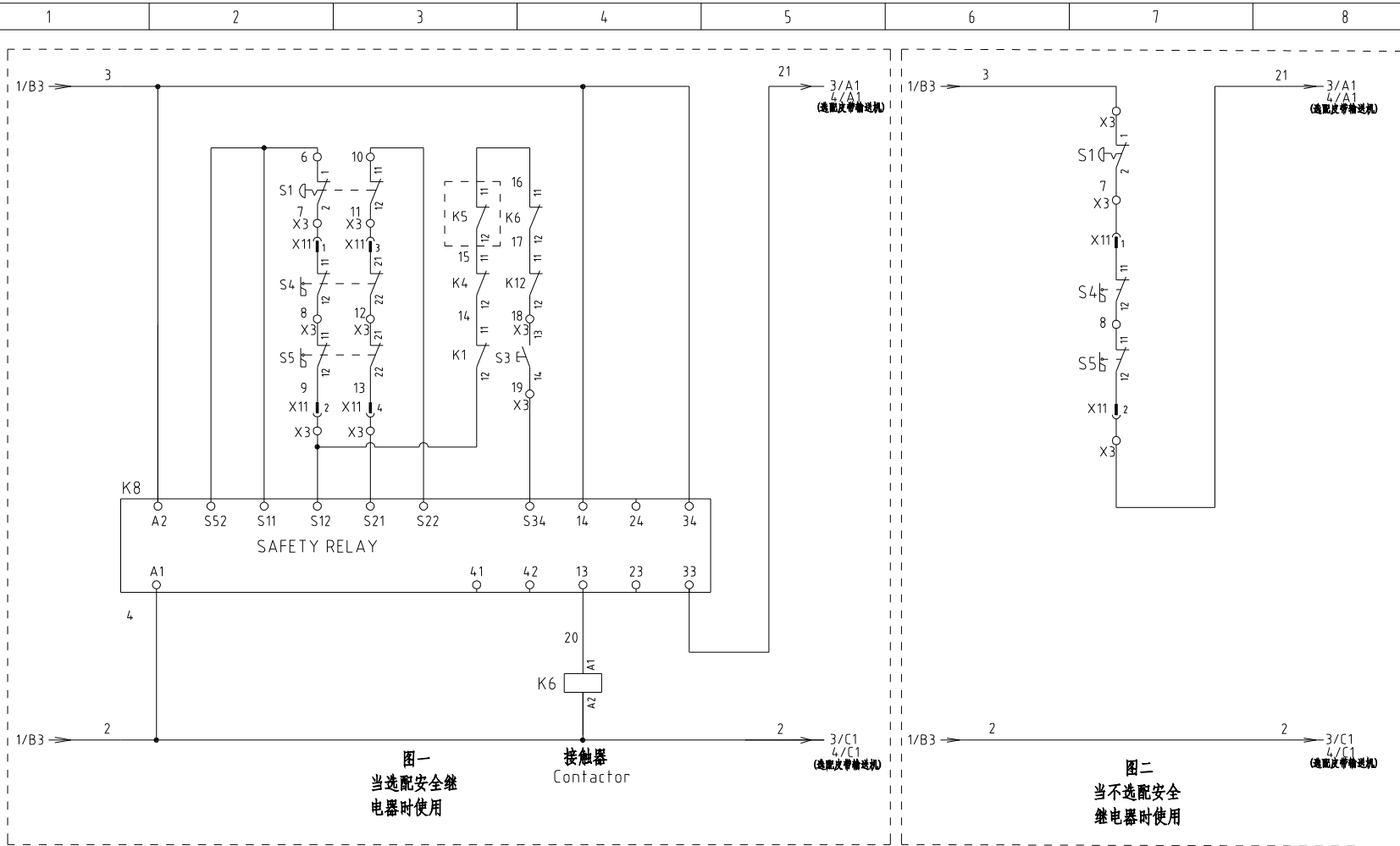

图一
当选配安全继电器时使用

接触器
Contactor

图二
当不选配安全继电器时使用

机型版本 Ver.E

制图	版号	J	标题	SG-4390(H)	图号	SG-4390(H)-CE-230V-J-2	比例	第 2 张
设计	核准		控制电路图一				标准	CE 共 12 张
校对	核准						机器电压	3φ230V
标记	更改前	更改后	更改人	日期	20220805		机器频率	50Hz



信易電熱機械股份有限公司
Shini Plastics Technologies, Inc.

1

2

3

4

5

6

7

8

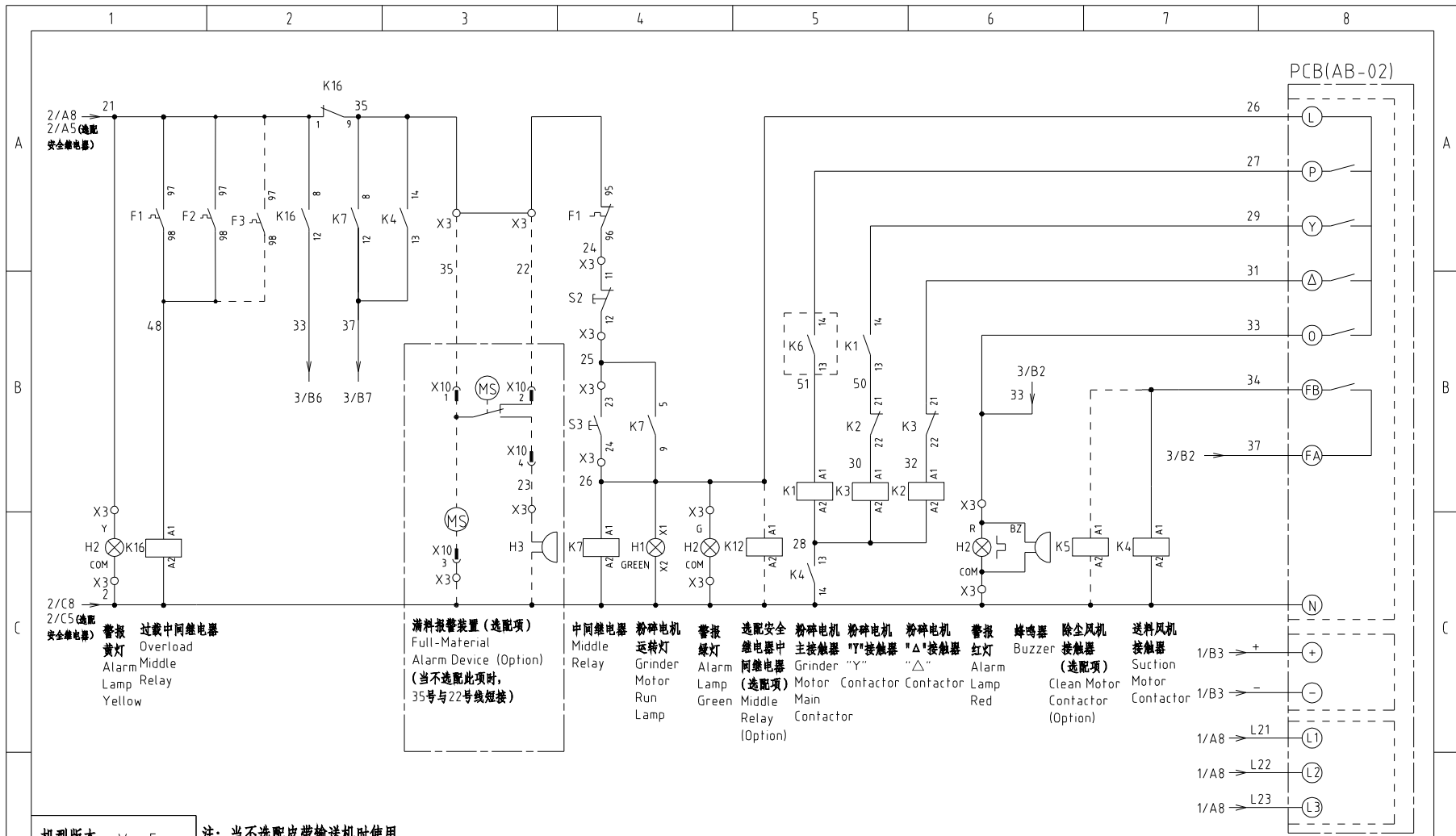

2/C8
2/C5 (选配
安全继电器)

警报 过载中间继电器
黄灯 Overload
Alarm Middle
Lamp Relay
Yellow

满料报警装置 (选选项)
Full-Material
Alarm Device (Option)
(当不选配此项时,
35号与22号线短接)

中间继电器
Middle
Relay

粉碎机
运转灯
Grinder
Motor
Run
Lamp

警报
绿灯
Alarm
Lamp
Green

选配安全
继电器中
间继电器
(选选项)
Middle
Relay
(Option)

粉碎机
主接触器
Grinder
Main
Contactor

粉碎机
"Y"接触器
Grinder
"Y"
Contactor

粉碎机
"Δ"接触器
Grinder
"Δ"
Contactor

警报
红灯
Alarm
Lamp
Red

蜂鸣器
Buzzer

除尘风机
接触器
(选选项)
Clean Motor
Contactor
(Option)

送料风机
接触器
Suction
Motor
Contactor

机型版本 Ver E 注: 当不选配皮带输送机时使用。

制图		版号 J		标题 SG-4390(H) 控制电路图二		图号 SG-4390(H)-CE-230V-J-3		比例		第 3 张	
设计		核准		SHINI		信易電熱機械股份有限公司 Shini Plastics Technologies, Inc.		标准 CE		共 12 张	
校对		日期 20220805		机器电压		3φ230V		机器频率		50Hz	
标记	更改前	更改后	更改人	日期	审核	日期	20220805				

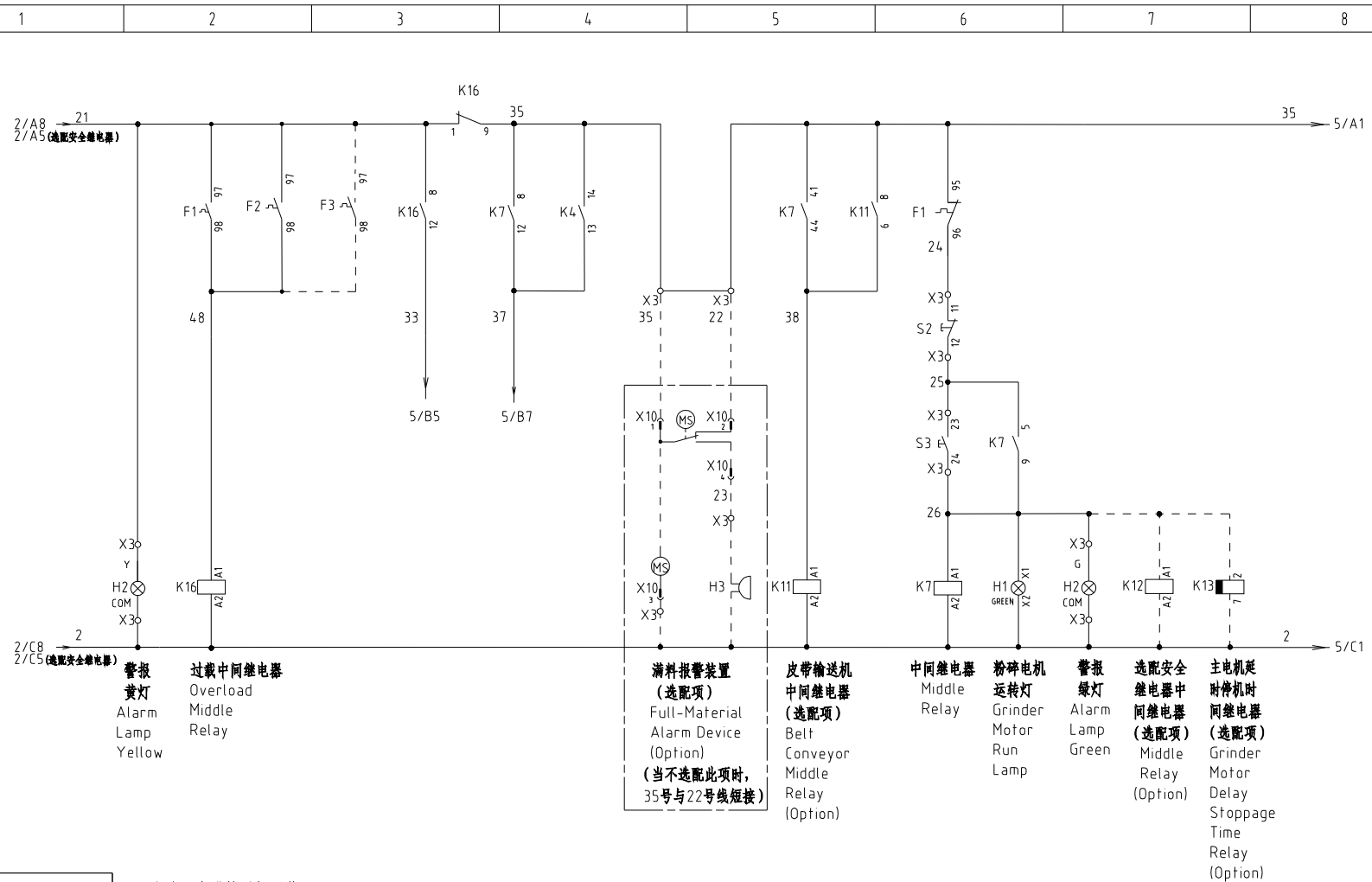

- 报警黄灯 Alarm Lamp Yellow
- 过载中间继电器 Overload Middle Relay
- 满料报警装置 (选配项) Full-Material Alarm Device (Option) (当不选配此项时, 35号与22号线短接)
- 皮带输送机中间继电器 (选配项) Belt Conveyor Middle Relay (Option)
- 中间继电器 Middle Relay
- 粉碎电机运转灯 Grinder Motor Run Lamp
- 报警绿灯 Alarm Lamp Green
- 选配安全继电器中间继电器 (选配项) Safety Relay Middle Relay (Option)
- 主机延时停机时间继电器 (选配项) Grinder Motor Delay Stoppage Time Relay (Option)

机型版本 Ver.E 注: 当选配皮带输送机时使用。

制图		版号		标题		图号		比例		第 4 张	
设计		核准		SG-4390(H)		SG-4390(H)-CE-230V-J-4		标准		共 12 张	
校对		日期		SHINI 信易电热机械股份有限公司 Shini Plastics Technologies, Inc.		20220805		机器电压		3φ230V	
审核								机器频率		50Hz	

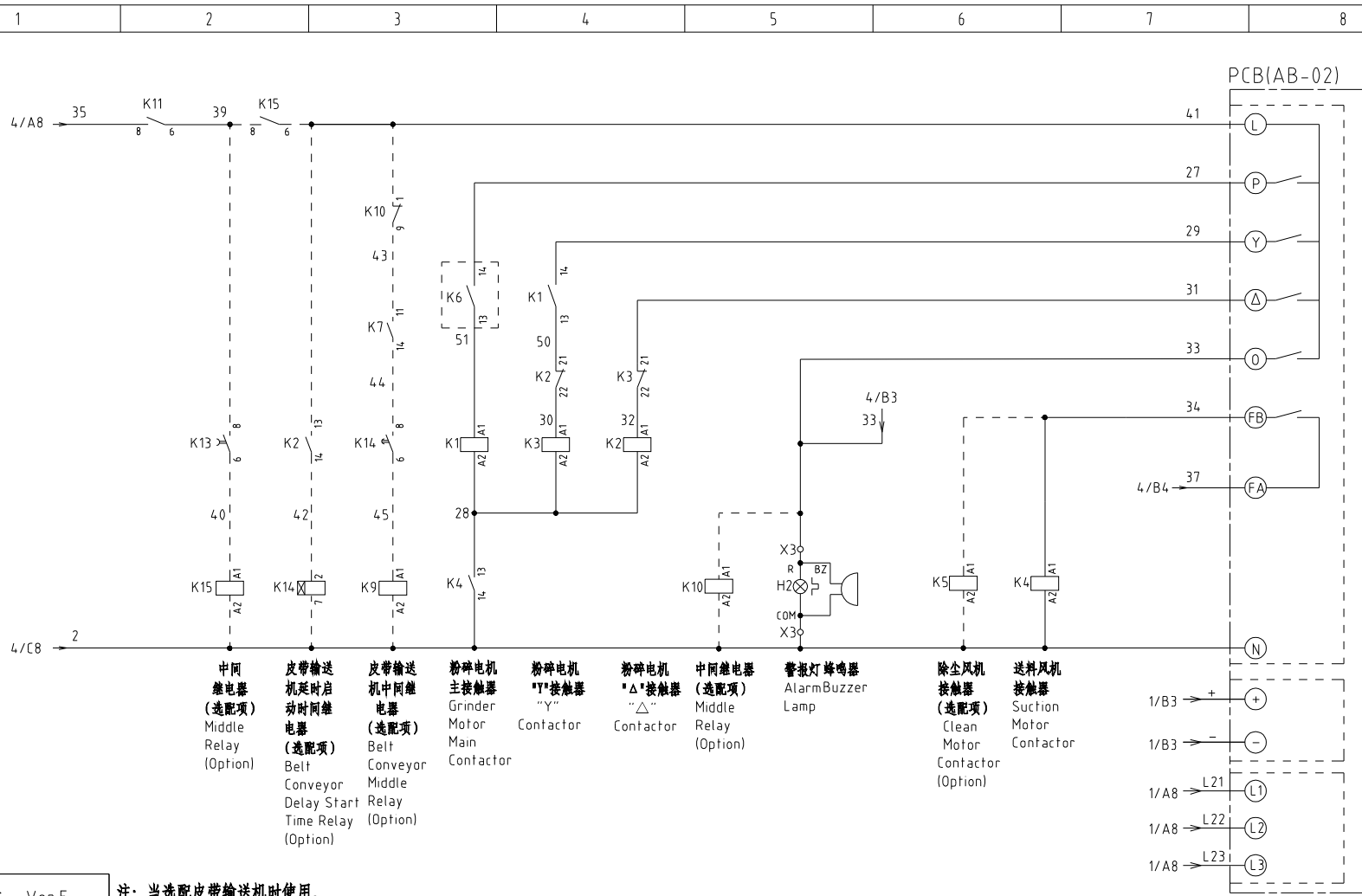

- 中间继电器 (选项) Middle Relay (Option)
- 皮带输送机延时启动时间继电器 (选项) Belt Conveyor Delay Start Time Relay (Option)
- 皮带输送机中间继电器 (选项) Belt Conveyor Middle Relay (Option)
- 粉碎机主接触器 Grinder Motor Main Contactor
- 粉碎机“Y”接触器 “Y” Contactor
- 粉碎机“Δ”接触器 “Δ” Contactor
- 中间继电器 (选项) Middle Relay (Option)
- 警报灯蜂鸣器 Alarm Buzzer Lamp
- 除尘风机接触器 (选项) Clean Motor Contactor (Option)
- 送料风机接触器 Suction Motor Contactor

注：当选配皮带输送机时使用。

机型版本 Ver.E					制图		版号 J	标题 SG-4390(H) 控制电路图六		图号 SG-4390(H)-CE-230V-J-5		比例	第 5 张	
					设计		核准					标准 CE	共 12 张	
					校对		日期 20220805	信易電熱機械股份有限公司 Shini Plastics Technologies, Inc.				机器电压	3φ230V	
标记	更改前	更改后	更改人	日期	审核	日期	机器频率			50Hz				

选配皮带输送机控制触点接线示意图

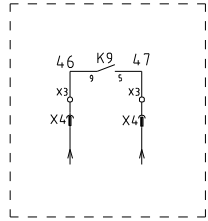

X4金属接头接线示意图
接皮带输送机
(选配项)

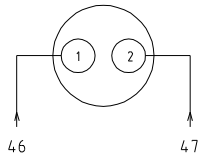

X10金属接头接线示意图
接满料报警装置
(选配项)

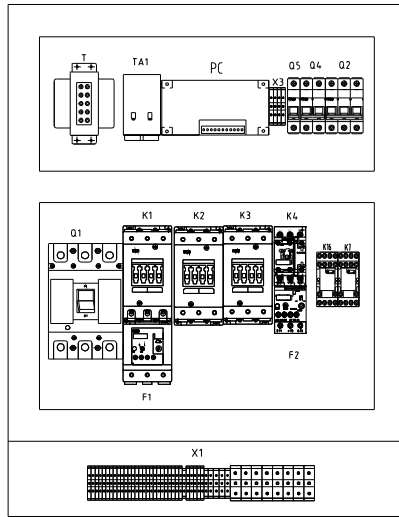
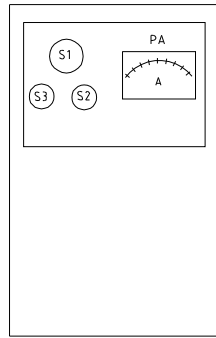
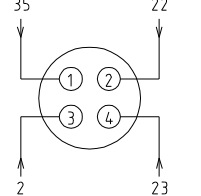

标准机型布局图

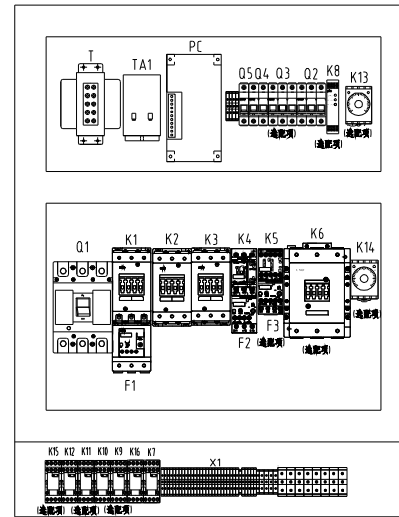

选配机型布局图

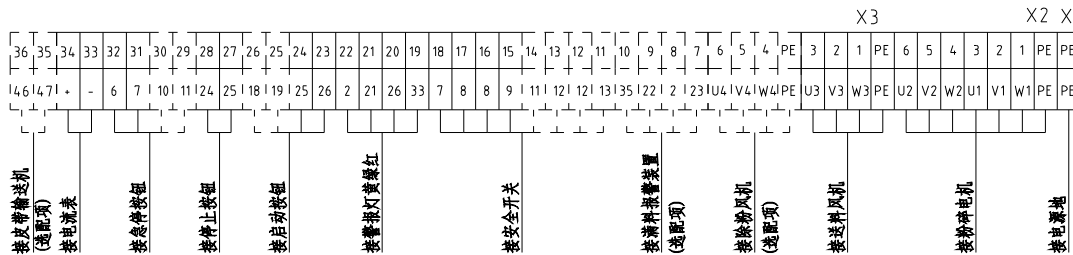

X11: 16P重载接插件

①	7	③
②	9	⑩
③	11	⑪
④	13	⑫
⑤		⑬
⑥		⑭
⑦		⑮
⑧		⑯

注: 当不选配安全继电器时将9号端子改为21号, 11号端子和13号端子不用接

机型版本 Ver.E 注: 当不选配安全继电器时将6号端子改为3号, 9号端子改为21号。

制图	版号	J	标题	SG-4390(H) 电气元件布置图	图号	SG-4390(H)-CE-230V-J-6	比例	第 6 张
设计	核准						标准	CE 共 12 张
校对							机器电压	3φ230V
标记	更改前	更改后	更改人	日期	20220805		机器频率	50Hz



信易電熱機械股份有限公司
Shini Plastics Technologies, Inc.

1		2		3		4		5		6		7		8	
序号/NO	符号/Symbol	名称/Name		制造商/Manufacturer		型号/Type		规格/Specification		数量/Number	物料编号/Material number		备注/Remark		
A	1	Q1	门连锁断路器/Gate Circuit-breaker		TECO		TAX-250L3160 3P		160A		1	YE40250300400			
	2		断路器外部操作把手/External operating handle		TECO		FB1R-CS1-C-D1(TAX-250)		----		1	YE90211200300			
	3	Q2	断路器/Circuit-breaker		TECO		BM-63C/3020S		20A		1	YE40302003000			
	4	Q2	断路器/Circuit-breaker		TECO		BM-63C/3P		63A		1	YE40306303000		(6)	
	5	Q3	断路器/Circuit-breaker		TECO		BM-63C/3010S		10A		1	YE40301003000		(2)	
	6	Q4	断路器/Circuit-breaker		TECO		BM-63C/2006S 2P		6A		1	YE40200600000			
	7	Q5	断路器/Circuit-breaker		TECO		BM-63C/1010S 1P		10A		1	YE40101000100			
B	8	K1,K2	接触器/Contactor		SIEMENS		3RT5046-1AC20		95A 24 VAC 50/60Hz		2	YE00504602600			
	9		辅助触点/Auxiliary Contactor		SIEMENS		3RH5921-1CA10		1NO		1	YE00592110000			
	10	K3	接触器/Contactor		SIEMENS		3RT5045-1AC20		80A 24 VAC 50/60Hz		1	YE00504502600			
	11		辅助触点/Auxiliary Contactor		SIEMENS		3RH5921-1CA01		1NC		2	YE00592110100			
	12		辅助触点/Auxiliary Contactor		SIEMENS		3RH5921-1CA10		1NO		1	YE00592110000		(5)	
	13		辅助触点/Auxiliary Contactor		SIEMENS		3RH5921-1CA01		1NC		1	YE00592110100		(4)	
	14	K4	接触器/Contactor		SIEMENS		3RT6025-1AC20		17A 24 VAC 50/60Hz		1	YE00602502600			
C	15	K4	接触器/Contactor		SIEMENS		3RT6028-1AC20		38A 24 VAC 50/60Hz		1	YE00602802600		(6)	
	16		辅助触点/Auxiliary Contactor		SIEMENS		3RH6911-1HA11		1NC+1NO		1	YE00691100100			
	17	K5	接触器/Contactor		SIEMENS		3RT6016-1AB02		9A 24 VAC 50/60Hz		1	YE00601602600		(2)	
	18	K6	接触器/Contactor		SIEMENS		3RT5055-6AB36		150A 24 VAC 50/60Hz		1	YE00505500600		(4)	
	19		辅助触点/Auxiliary Contactor		SIEMENS		3RH5921-1CA01		1NC		1	YE00592110100		(4)	
	20		辅助触点/Subsidiary Contactor		SIEMENS		3RH5921-1CA10		1NO		1	YE00592110000		(4)	
	21	K7	中间继电器/Middle relay		Honeywell		GR-2C-AC24V		24 VAC		1	YE03022400300			
D	22	K7	中间继电器/Middle relay		Honeywell		GR-4C-AC24V		24 VAC		1	YE03042400300		(5)	
	23	K8	安全继电器/Safety relay		PILZ		PNOZ×2.8P		24V AC/DC		1	YE04023000000		(4)	
	24	K9 K10 K11 K15	中间继电器/Middle relay		Honeywell		GR-2C-AC24V		24 VAC		4	YE03022400300		(5)	
	25	K12	中间继电器/Middle relay		Honeywell		GR-2C-AC24V		24 VAC		1	YE03022400300		(4)	
	机型版本 Ver.E		注: (1)表示非电控箱内材料; (2)表示除尘风机及配件; (3)表示满料报警装置及配件; (4)表示安全继电器及配件; (5)表示皮带输送机及配件; (6)表示加大风机功率及配件。												
				制图		版号 J		标题 SG-4390		图号 SG-4390(H)-CE-230V-J-7		比例		第 7 张	
				设计		核准		电气元件明细一				标准 CE		共 12 张	
				校对				 信易電熱機械股份有限公司 Shini Plastics Technologies, Inc.		机器电压		3φ230V			
标记		更改前		更改后		更改人				日期 20220805		机器频率		50Hz	
1		2		3		4		5		6		7		8	

1	2	3	4	5	6	7	8						
序号/NO	符号/Symbol	名称/Name	制造商/Manufacturer	型号/Type	规格/Specification	数量/Number	物料编号/Material number	备注/Remark					
26	K13	定时器/Timer	YUYUN	TRF-N/3M	24VAC	1	YE86032400000	(5)					
27	K14	定时器/Timer	YUYUN	TH3A-NAB 60S	24VAC	1	YE86602400300	(5)					
28	F1	热过载继电器/Overload relay	SIEMENS	3RU5146-4KB0	57-75A	1	YE01514650000						
29	F2	热过载继电器/Overload relay	SIEMENS	3RU6126-1JB0	7-10A	1	YE01260700000						
30	F2	热过载继电器/Overload relay	SIEMENS	3RU6126-4EB0	27-32A	1	YE01612600600	(6)					
31	F3	热过载继电器/Overload relay	SIEMENS	3RU1116-1EB0	2.8-4A	1	YE01160280000	(2)					
32	K16	中间继电器/Middle relay	Honeywell	GR-2C-AC24V	24VAC	1	YE03022400300						
33	S1	急停按钮/Emergency stop button	SCHNEIDER	XB2BS542C	400VAC	1	YE11254200000	(1)					
34		触点块/Contact block	SCHNEIDER	ZB2BE102C	1NC	1	YE00210203100	(1)(4)					
35	S2	停止按钮/Stop button	SCHNEIDER	XB2BA22C	400VAC	1	YE11222000000	(1)					
36	S3,H1	启动按钮(带灯)/Start button	SCHNEIDER	XB2BW33B1C	24VAC	1	YE11233100000	(1)					
37		触点块/Contact block	SCHNEIDER	ZB2BE101C	1NO	1	YE00210103100	(1)(4)					
38	S4,S5	安全开关/Safety switch	SCHMERSRC	AZ16-02ZVRK-1476	230VAC	2	YE16147600000	(1)(4)					
39	S4,S5	安全开关/Safety switch	SCHMERSRC	AZ15-02ZVRK-1476	230VAC	2	YE16147600100	(1)					
40	H2	三色警报灯/Alarm lamp	SHINI	红绿黄优先顺序+蜂鸣器	24VAC/DC 50/60Hz	1	BL90002401520	(1)					
41	H3	蜂鸣器/Buzzer	TEND	EA-2	24VAC	1	YE84240200000	(1)(3)					
42	MS	料位马达/Feed position motor	SHINI	SR-80	24VAC	1	YE15802400100	(1)(3)					
43	T	互感变压器/Transformer	----	IN=230/200V OUT=24VAC	300VA	1	YE70023005000						
44	TA1	电流互感器/Current mutual inductance	RATIO	RQT-35	100/5A	1	YE04100500000						
45	PA	电流表/Galvanometry	SFIM	DH-670	100/5A	1	YE25671000000	(1)					
46	PCB	微电脑板/PCB	YUYUN	AB-02	24VAC	1	YE80022400100						
47		塑膠外壳SI-4T線路板用	----	----	----	1	YR40000400100						
48	TA2	电流互感器/Current mutual inductance	YUYUN	----	5-100A	1	----	线路板自带					
49	X1	端子排/Terminal	Honeywell	GK35PE	35mm ² PE	1	YE60003503500						
50	X2	端子排/Terminal	Honeywell	GK35	35mm ²	6	YE60003503200						
机型版本 Ver.E		注: (1)表示非电控箱内材料; (2)表示除尘风机选配配件; (3)表示满料报警装置选配配件; (4)表示安全继电器选配配件; (5)表示皮带输送机选配配件; (6)表示加大风机功率选配配件。											
		制图		版号 J		标题 SG-4390		图号		比例		第 8 张	
		设计		核 准		电气元件明细二		SG-4390(H)-CE-230V-J-8		标准 CE		共 12 张	
		校对		核 准		 信易電熱機械股份有限公司 Shini Plastics Technologies, Inc.		机器电压		3φ230V			
标记		更改前						更改后		更改人		机器频率	
日期		日期		20220805									

1	2	3	4	5	6	7	8		
序号/NO	符号/Symbol	名称/Name	制造商/Manufacturer	型号/Type	规格/Specification	数量/Number	物料编号/Material number	备注/Remark	
51		端子排/Terminal	Honeywell	GK16PE	16mm ² PE	1	YE60001603500		
52	X3	端子排/Terminal	Honeywell	SK2.5	2.5mm ²	21	YE60002503200		
53			Honeywell	GK2.5PE	2.5mm ² PE	1	YE60002503400		
54			Honeywell	SK2.5	2.5mm ²	5	YE60002503200	(2)	
55			Honeywell	GK2.5PE	2.5mm ² PE	1	YE60002503400	(2)	
56			Honeywell	SK2.5	2.5mm ²	4	YE60002503200	(3)	
57			Honeywell	SK2.5	2.5mm ²	2	YE60002503200	(5)	
58			Honeywell	SK2.5	2.5mm ²	8	YE60002503200	(4)	
59			Honeywell	SK6	6mm ²	3	YE60000603200	(6)	
60			Honeywell	SK6PE	6mm ² PE	1	YE60000603500	(6)	
61		终端固定件B/GK系列	Honeywell	----	PCS	4	YE60000003900		
62	X4	金属接头/Metal tie in	SHINI	PLT-162-RR(公)	2P	1	YE68016200100	(1)(5)	
63	X10	金属接头/Metal tie in	SHINI	PLT-254-PM	4P	1	YE68025400000	(1)(3)	
64		金属接头/Metal tie in	----	PLT-254-RF	4P	1	YE68025400100	(1)(3)	
65	X11	重载接插件/Heavy duty connector	HARTING	16P+PE(公插·母座)	16P	1	YE68001601300	(1)	
65	M1	粉碎电机/Granulating motor	----	----	400V 50Hz 37kW	1	----	(1)	
66	M2	送料风车/Solution blower	----	----	400V 50Hz 2.2kW	1	----	(1)	
67	M2	送料风车/Solution blower	----	----	400V 50Hz 7.5kW	1	----	(1)(6)	
68	M3	除尘风车/Dust blower	----	----	400V 50Hz 0.75kW	1	----	(1)(2)	
机型版本 Ver.E		注: (1)表示非电控箱内材料; (2)表示除尘风机选配件; (3)表示满料报警装置选配件; (4)表示安全继电器选配件; (5)表示皮带输送机选配件; (6)表示加大风机功率选配件。							
D			制图	版号	J	标题	图号	比例	第 9 张
			设计	核准		SG-4390	SG-4390(H)-CE-230V-J-9	标准	CE
			校对			电气元件明细三			共 12 张
	标记	更改前	更改后	更改人	日期	20220805	 信易電熱機械股份有限公司 Shini Plastics Technologies, Inc.	机器电压	3φ230V
								机器频率	50Hz

1		2		3		4		5		6		7		8	
序号/NO	符号/Symbol	名称/Name		制造商/Manufacturer	型号/Type		规格/Specification		数量/Number	物料编号/Material number		备注/Remark			
A	1	Q1	门连锁断路器/Gate Circuit-breaker		TECO	TAX-250L3200 3P		200A		1	YE40250300500				
	2		断路器外部操作把手/External operating handle		TECO	FB2R-CS1-C-D1(TAX-250)		----		1	YE90211200300				
	3	Q2	断路器/Circuit-breaker		TECO	BM-63C/3020S		20A		1	YE40302003000				
	4	Q2	断路器/Circuit-breaker		TECO	BM-63C/3P		63A		1	YE40306303000		(6)		
	5	Q3	断路器/Circuit-breaker		TECO	BM-63C/3010S		10A		1	YE40301003000		(2)		
	6	Q4	断路器/Circuit-breaker		TECO	BM-63C/2006S 2P		6A		1	YE40200600000				
	7	Q5	断路器/Circuit-breaker		TECO	BM-63C/1010S 1P		10A		1	YE40101000100				
B	8	K1,K2	接触器/Contactor		SIEMENS	3RT5054-1AB36		115A 24VAC 50/60Hz		2	YE00505400900				
	9		辅助触点/Auxiliary Contactor		SIEMENS	3RH5921-1CA01		1NC		1	YE00592110100		(4)		
	10		辅助触点/Auxiliary Contactor		SIEMENS	3RH5921-1CA01		1NC		1	YE00592110100				
	11		辅助触点/Auxiliary Contactor		SIEMENS	3RH5921-1CA10		1NO		1	YE00592110000		(5)		
	12		辅助触点/Auxiliary Contactor		SIEMENS	3RH5921-1CA10		1NO		1	YE00592110000				
	13	K3	接触器/Contactor		SIEMENS	3RT5046-1AC20		95A 24VAC 50/60Hz		1	YE00504602600				
	14	K4	接触器/Contactor		SIEMENS	3RT6025-1AC20		17A 24VAC 50/60Hz		1	YE00602502600				
C	15	K4	接触器/Contactor		SIEMENS	3RT6028-1AC20		38A 24VAC 50/60Hz		1	YE00602802600		(6)		
	16		辅助触点/Auxiliary Contactor		SIEMENS	3RH6911-1HA11		1NC+1NO		1	YE00691100100				
	17	K5	接触器/Contactor		SIEMENS	3RT6016-1AB02		9A 24VAC 50/60Hz		1	YE00601602600		(2)		
	18	K6	接触器/Contactor		SIEMENS	3RT5056-6AB36		185A 24VAC 50/60Hz		1	YE00505600300		(4)		
	19		辅助触点/Auxiliary Contactor		SIEMENS	3RH5921-1CA01		1NC		1	YE00592110100		(4)		
	20		辅助触点/Subsidiary Contactor		SIEMENS	3RH5921-1CA10		1NO		1	YE00592110000		(4)		
	21	K7	中间继电器/Middle relay		Honeywell	GR-2C-AC24V		24VAC		1	YE03022400300				
D	22	K7	中间继电器/Middle relay		Honeywell	GR-4C-AC24V		24VAC		1	YE03042400300		(5)		
	23	K8	安全继电器/Safety relay		PILZ	PNOZ×2.8P		24V AC/DC		1	YE04023000000		(4)		
	24	T	互感器/Transformer		----	IN=230/200V OUT=24VAC		300VA		1	YE70023005000				
	25	K9 K10 K11 K15	中间继电器/Middle relay		Honeywell	GR-2C-AC24V		24VAC		4	YE03022400300		(5)		
	机型版本 Ver.E		注: (1)表示非电控箱内材料; (2)表示除尘马达选配件; (3)表示满料报警装置选配件; (4)表示安全继电器选配件; (5)表示皮带输送机选配件; (6)表示加大风机功率选配项。												
				制图	版号 J		标题 SG-4390H		图号 SG-4390(H)-CE-230V-J-10		比例	第 10 张			
				设计	核准		电气元件明细一				标准	CE 共 12 张			
				校对			 信易電熱機械股份有限公司 Shini Plastics Technologies, Inc.				机器电压	3φ230V			
标记	更改前	更改后	更改人	日期	审核	日期			20220805			机器频率	50Hz		
1		2		3		4		5		6		7		8	

1		2		3		4		5		6		7		8	
序号/NO	符号/Symbol	名称/Name		制造商/Manufacturer	型号/Type		规格/Specification		数量/Number	物料编号/Material number		备注/Remark			
A	26	K12	中间继电器/Middle relay		Honeywell	GR-2C-AC24V		24VAC	1	YE03022400300		(4)			
	27	K13	定时器/Timer		YUYUN	TRF-N/3M		24VAC	1	YE86032400000		(5)			
	28	K14	定时器/Timer		YUYUN	TH3A-NAB 60S		24VAC	1	YE86602400300		(5)			
	29	F1	热过载继电器/Overload relay		SIEMENS	3RU5146-4MB0		80-100A	1	YE01514680000					
	30		S3独立安装底座		SIEMENS	3RU5946-3AA01		S3	1	YE01594600000					
	31	F2	热过载继电器/Overload relay		SIEMENS	3RU6126-1JB0		7-10A	1	YE01260700000					
	32	F2	热过载继电器/Overload relay		SIEMENS	3RU6126-4EB0		27-32A	1	YE01612600600		(6)			
B	33	F3	热过载继电器/Overload relay		SIEMENS	3RU1116-1EB0		2.8-4A	1	YE01160280000		(2)			
	34	K16	中间继电器/Middle relay		Honeywell	GR-2C-AC24V		24VAC	1	YE03022400300					
	35	S1	急停按钮/Emergency stop button		SCHNEIDER	XB2BS542C		400VAC	1	YE11254200000		(1)			
	36		触点块/Contact block		SCHNEIDER	ZB2BE102C		1NC	1	YE00210203100		(1)(4)			
	37	S2	停止按钮/Stop button		SCHNEIDER	XB2BA22C		400VAC	1	YE11222000000		(1)			
	38	S3,H1	启动按钮(带灯)/Start button		SCHNEIDER	XB2BW33B1C		24VAC	1	YE11233100000		(1)			
	39		触点块/Contact block		SCHNEIDER	ZB2BE101C		1NO	1	YE00210103100		(1)(4)			
C	40	S4,S5	安全开关/Safety switch		SCHMERSRC	AZ15-02ZVRK-1476		24VAC	2	YE16147600100		(1)			
	41	S4,S5	安全开关/Safety switch		SCHMERSRC	AZ16-02ZVRK-1476		24VAC	2	YE16147600000		(1)(4)			
	42	H2	三色警报灯/Alarm lamp		SHINI	红绿黄优先顺序+蜂鸣器		24VAC/DC 50/60Hz	1	BL90002401520		(1)			
	43	H3	蜂鸣器/Buzzer		TEND	EA-2		24VAC	1	YE84240200000		(1)(3)			
	44	MS	料位马达/Feed position motor		SHINI	SR-80		24VAC	1	YE15802400100		(1)(3)			
	45	X1	端子排/Terminal		Honeywell	GK35PE		35mm ² PE	1	YE60003503500					
	46	X2	端子排/Terminal		Honeywell	GK35		35mm ²	6	YE60003503200					
	47				Honeywell	GK16PE		16mm ² PE	1	YE60001603500					
	48	X3	端子排/Terminal		Honeywell	SK2.5		2.5mm ²	21	YE60002503200					
	49				Honeywell	GK2.5PE		2.5mm ² PE	1	YE60002503400					
50				Honeywell	SK2.5		2.5mm ²	5	YE60002503200		(2)				
机型版本 Ver E		注: (1)表示非电控箱内材料; (2)表示除尘马达选配件; (3)表示满料报警装置选配件; (4)表示安全继电器选配件; (5)表示皮带输送机选配件; (6)表示加大风机功率选配项。													
D					制图	版号 J		标题	SG-4390H		图号	比例		第 11 张	
					设计	核 准		电气元件明细二		SG-4390(H)-CE-230V-J-11		标准 CE		共 12 张	
					校对			 信易電熱機械股份有限公司 Shini Plastics Technologies, Inc.		机器电压		3φ230V			
	标记	更改前	更改后	更改人	日期	审核	日期			20220805	机器频率		50Hz		
1		2		3		4		5		6		7		8	

1		2		3		4		5		6		7		8	
序号/NO	符号/Symbol	名称/Name		制造商/Manufacturer	型号/Type		规格/Specification		数量/Number	物料编号/Material number		备注/Remark			
51				Honeywell	GK2.5PE		2.5mm ² PE		1	YE60002503400		(2)			
52				Honeywell	SK2.5		2.5mm ²		4	YE60002503200		(3)			
53				Honeywell	SK2.5		2.5mm ²		2	YE60002503200		(5)			
54				Honeywell	SK2.5		2.5mm ²		8	YE60002503200		(4)			
55				Honeywell	SK6		6mm ²		3	YE60000603200		(6)			
56				Honeywell	SK6PE		6mm ² PE		1	YE60000603500		(6)			
57		终端固定件B/GI系列		Honeywell	----		PCS		4	YE60000003900					
58		端板2.5		Honeywell	SK2.5		PCS		1	YE60002501100					
59	X4	金属接头/Metal tie in		SHINI	PLT-162-RR(公)		2P		1	YE68016200100		(1)(5)			
60	X10	金属接头/Metal tie in		SHINI	PLT-254-PM		4P		1	YE68025400000		(1)(3)			
61		金属接头/Metal tie in		SHINI	PLT-254-RF		4P		1	YE68025400100		(1)(3)			
62	X11	重载接插件/Heavy duty connector		HARTING	16P+PE(公插+母座)		16P		1	YE68001601300		(1)			
63	PCB	微电脑板/PCB		YUYUN	AB-02		24VAC		1	YE80022400100					
64		塑膠外殼SI-4T線路板用		----	----		----		1	YR40000400100					
65	PA	电流表/Galvanometry		SFIM	DH-670		100/5A		1	YE25671000000		(1)			
66	TA1	电流互感器/Current mutual inductance		RATIO	RQT-10		100/5A		1	YE04100500000					
67	TA2	电流互感器/Current mutual inductance		YUYUN	----		5-100A		1	----		线路板自带			
68	M1	粉碎电机/Granulating motor		----	----		400V 50Hz 30kW		1	----		(1)			
69	M2	送料风车/Solution blower		----	----		400V 50Hz 2.2kW		1	----		(1)			
70	M2	送料风车/Solution blower		----	----		400V 50Hz 7.5kW		1	----		(1)(6)			
	M3	除尘风车/Dust blower		----	----		400V 50Hz 0.75kW		1	----		(1)(2)			
机型版本 Ver.E 注: (1)表示非电控箱内材料; (2)表示除尘马达选配件; (3)表示满料报警装置选配件; (4)表示安全继电器选配件; (5)表示皮带输送机选配件; (6)表示加大风机功率选配项。															
制图		版号		标题		图号		比例		第 12 张		D			
设计		核准		SG-4390H		SG-4390(H)-CE-230V-J-12		标准		CE		共 12 张			
校对		日期		SHINI		信易電熱機械股份有限公司		机器电压		3φ230V					
核 准		日期		Shini Plastics Technologies, Inc.		机器频率		50Hz							
标记	更改前	更改后	更改人	日期	审核	日期	20220805								
1	2	3	4	5	6	7	8								

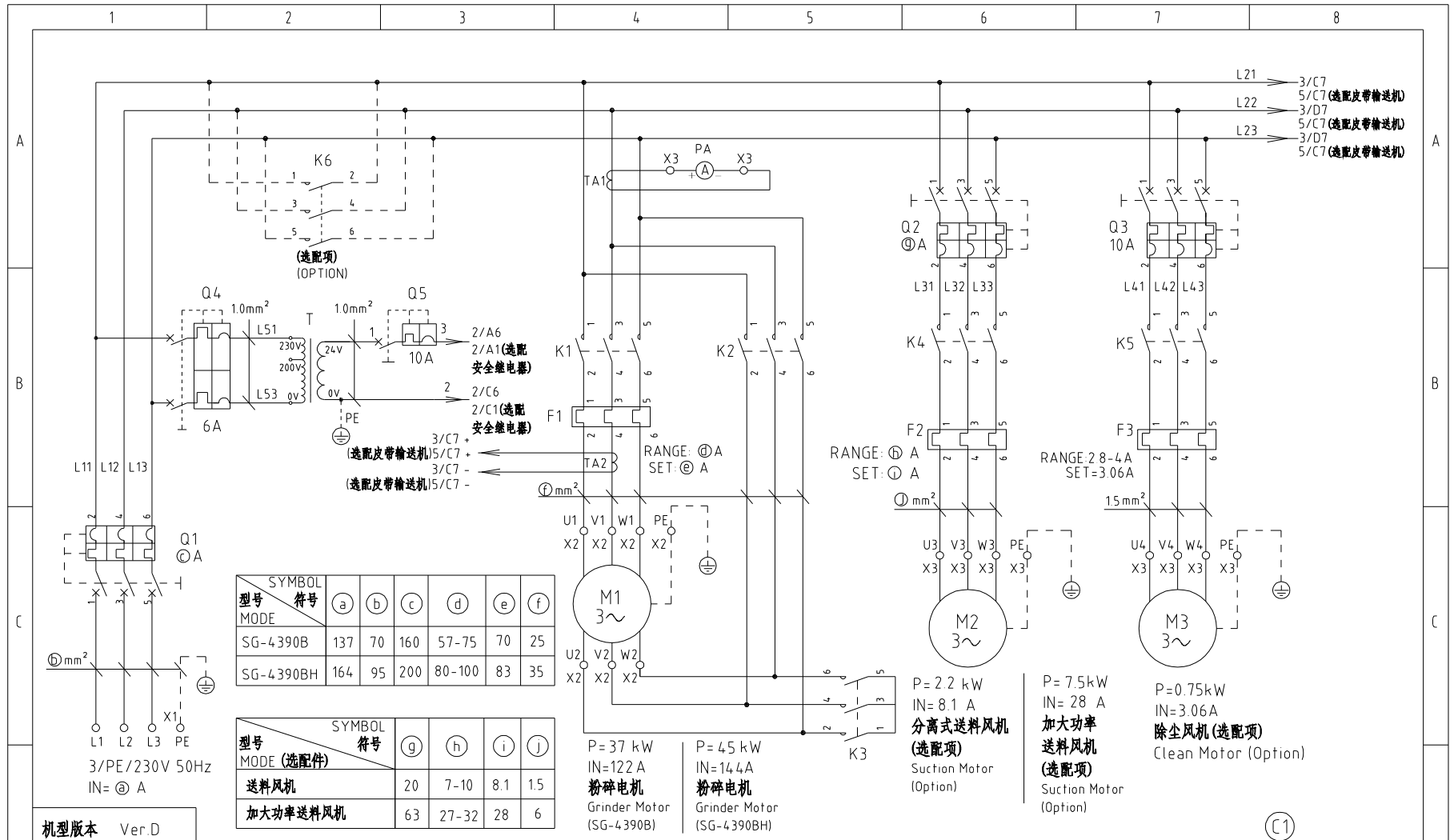

SYMBOL		MODE					
型号	符号	(a)	(b)	(c)	(d)	(e)	(f)
SG-4390B		137	70	160	57-75	70	25
SG-4390BH		164	95	200	80-100	83	35

SYMBOL		MODE (选配件)			
型号	符号	(g)	(h)	(i)	(j)
送料风机		20	7-10	8.1	1.5
加大功率送料风机		63	27-32	28	6

P=37 kW
 IN=122 A
粉碎电机
 Grinder Motor
 (SG-4390B)

P=45 kW
 IN=14.4 A
粉碎电机
 Grinder Motor
 (SG-4390BH)

P=2.2 kW
 IN=8.1 A
分离式送料风机
 (选配项)
 Suction Motor
 (Option)

P=7.5 kW
 IN=28 A
加大功率送料风机
 (选配项)
 Suction Motor
 (Option)

P=0.75 kW
 IN=3.06 A
除尘风机 (选配项)
 Clean Motor (Option)

机型版本 Ver.D

制图		版号		标题		图号		比例		第 1 张	
设计		核准		SG-4390(H)		SG-4390(H)-GB-230V-C-1		标准		共 12 张	
校对		日期		主电路图		信易電熱機械股份有限公司		机器电压		3Ø230V	
审核		20220805		SHINI		Shini Plastics Technologies, Inc.		机器频率		50Hz	
标记	更改前	更改后	更改人	日期	审核	日期	20220805				

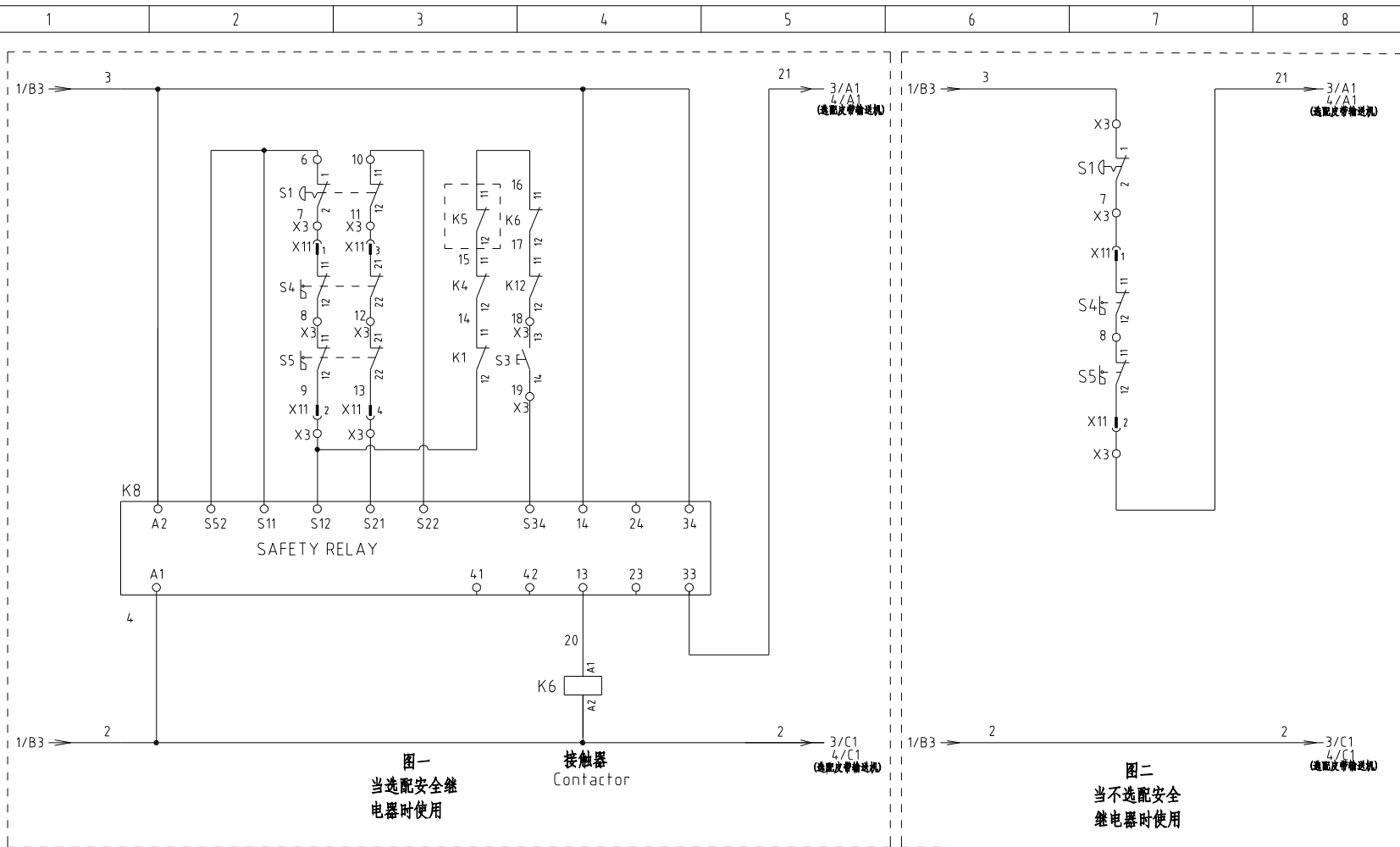

图一
当选配安全继电器时使用

接触器
Contactor

图二
当不选配安全继电器时使用

机型版本 Ver.D

Ⓒ1

制图		版号		标题		图号		比例		第 2 张	
设计		核 准		SG-4390B(H) 控制电路图一		SG-4390B(H)-GB-230V-C-2		标准 GB		共 12 张	
校 对		日 期		日期		20220805		机器电压		3Ø230V	
Ⓒ1 标准CE		标准GB		校 对		日期		机器频率		50Hz	
标记	更改前	更改后	更改人	日期	审核	日期	20220805				



信易電熱機械股份有限公司
Shini Plastics Technologies, Inc.

1

2

3

4

5

6

7

8

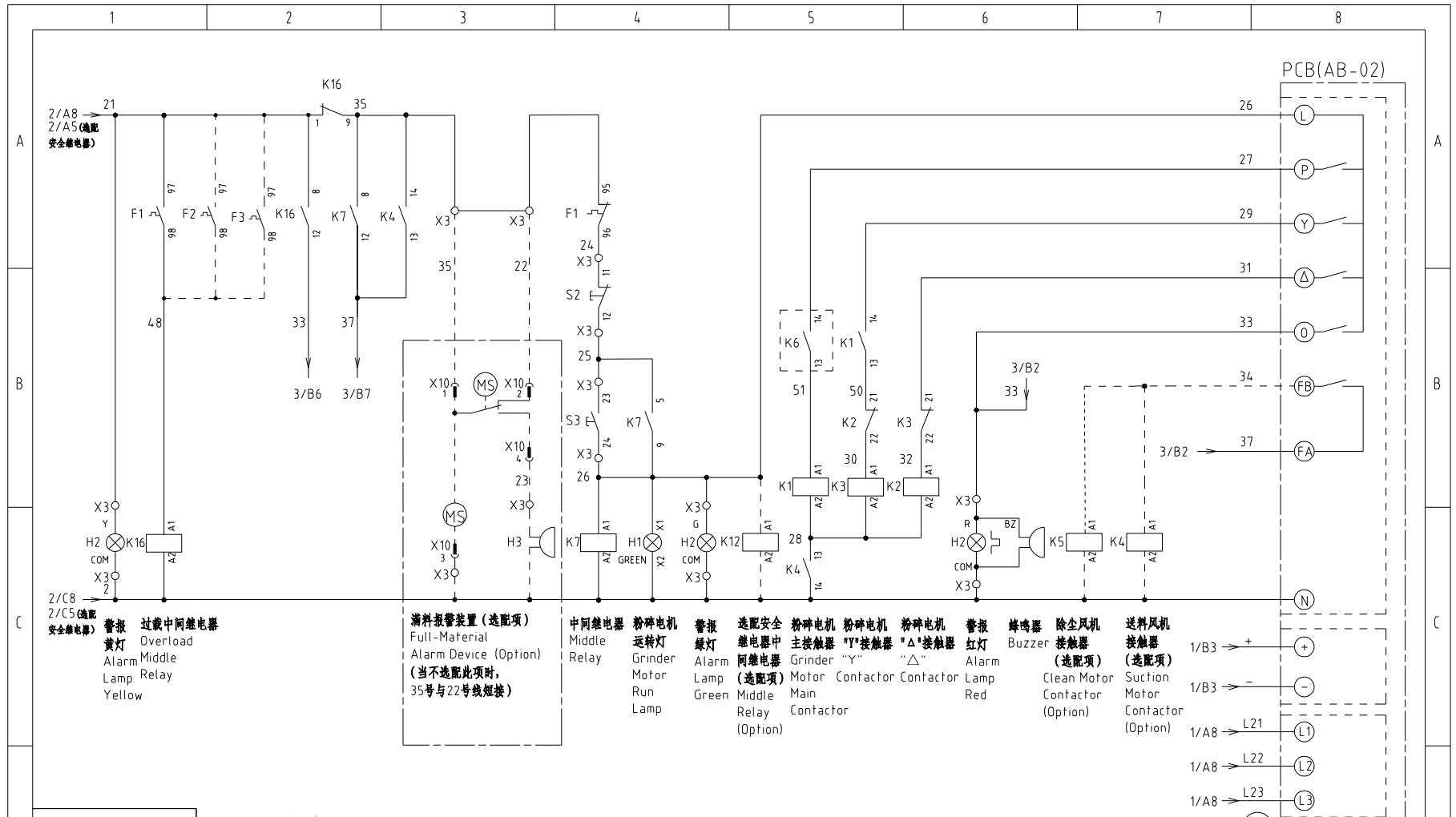

2/C8
2/C5 (选配
安全继电器)

警报
黄灯
Alarm
Lamp
Yellow

过载中间继电器
Overload
Middle
Relay
Yellow

满料报警装置 (选选项)
Full-Material
Alarm Device (Option)
(当不选配此项时,
35号与22号线短接)

中间继电器
Middle
Relay

粉碎机
运转灯
Grinder
Motor
Run
Lamp

警报
绿灯
Alarm
Lamp
Green

选配安全
继电器中
间继电器
(选选项)
Middle
Main
Relay
(Option)

粉碎机
主接触器
Grinder
Motor
Contactor

粉碎机
"Y"接触器
Grinder
Motor
Contactor

粉碎机
"Δ"接触器
Grinder
Motor
Contactor

警报
红灯
Alarm
Lamp
Red

蜂鸣器
Buzzer

除尘风机
接触器
(选选项)
Clean Motor
Contactor
(Option)

送料风机
接触器
(选选项)
Suction
Motor
Contactor
(Option)

1/B3 → +
1/B3 → -
1/A8 → L21
1/A8 → L22
1/A8 → L23
C1

机型版本 Ver.D 注: 当不选配皮带输送机时使用。

制图		版号 C		标题 SG-4390(H) 控制电路图二		图号 SG-4390(H)-GB-230V-C-3		比例 第 3 张	
设计		核准		SHINI 信易電熱機械股份有限公司 Shini Plastics Technologies, Inc.		标准 GB		共 12 张	
校对		日期 20220805		机器电压 3Ø230V		机器频率 50Hz			
标记	更改前	更改后	更改人	日期	审核				

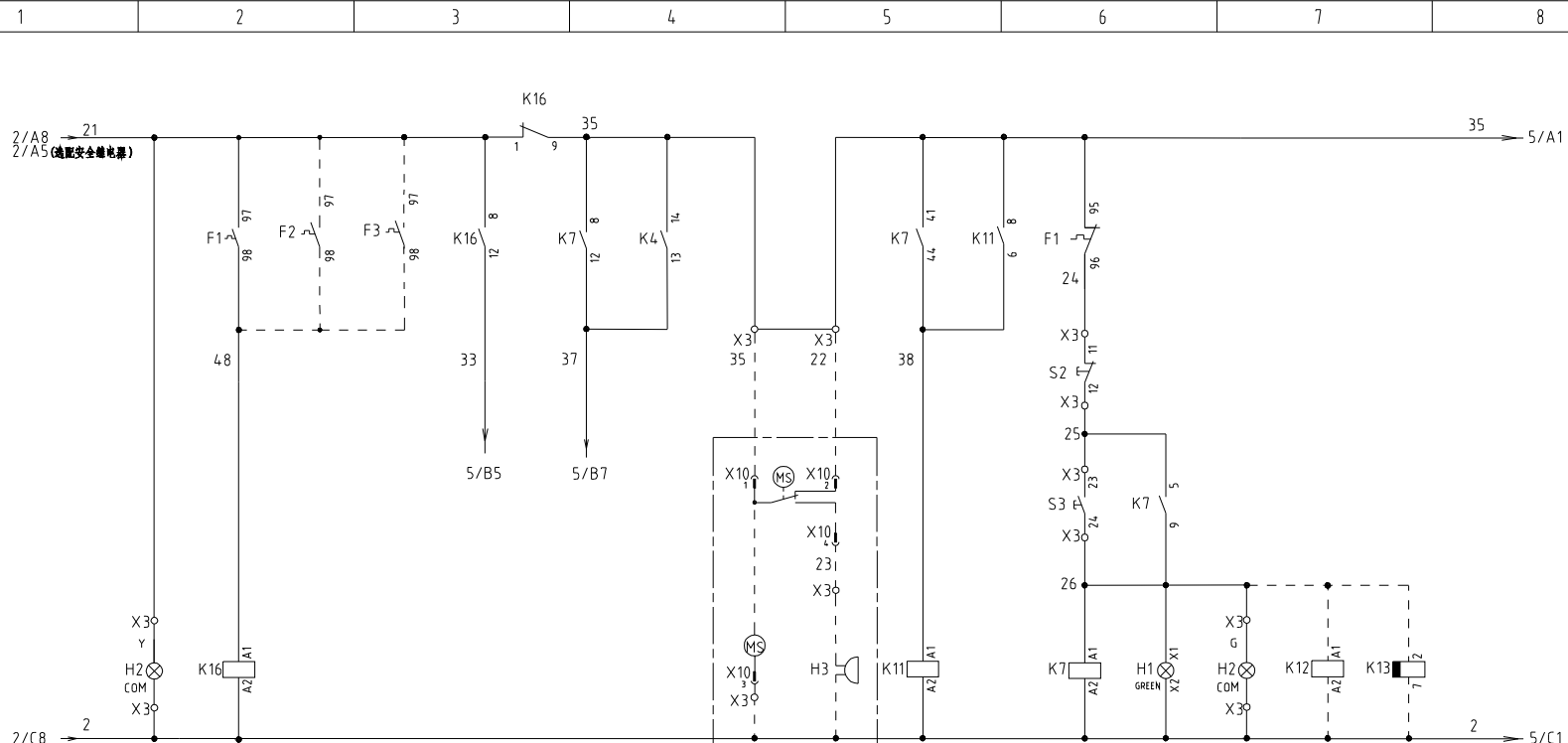

- 报警黄灯 Alarm Lamp Yellow
- 过载中间继电器 Overload Middle Relay
- 满料报警装置 (选配项) Full-Material Alarm Device (Option) (当不选配此项时, 35号与22号线短接)
- 皮带输送机中间继电器 (选配项) Belt Conveyor Middle Relay (Option)
- 中间继电器 Middle Relay
- 粉碎电机运转灯 Grinder Motor Run Lamp
- 报警绿灯 Alarm Lamp Green
- 选配安全继电器中间继电器 (选配项) Safety Relay Middle Relay (Option)
- 主机机时继电器 (选配项) Main Machine Stoppage Time Relay (Option)

机型版本 Ver.D		注: 当选配皮带输送机时使用。								
				制图		版号 C	标题 SG-4390B(H) 控制电路图四	图号 SG-4390B(H)-GB-230V-C-4	比例 GB	第 4 张
				设计		核准			标准 GB	共 12 张
①	标准CE	标准GB		校对					机器电压	3Ø230V
标记	更改前	更改后	更改人	日期	审核	日期	20220805		机器频率	50Hz



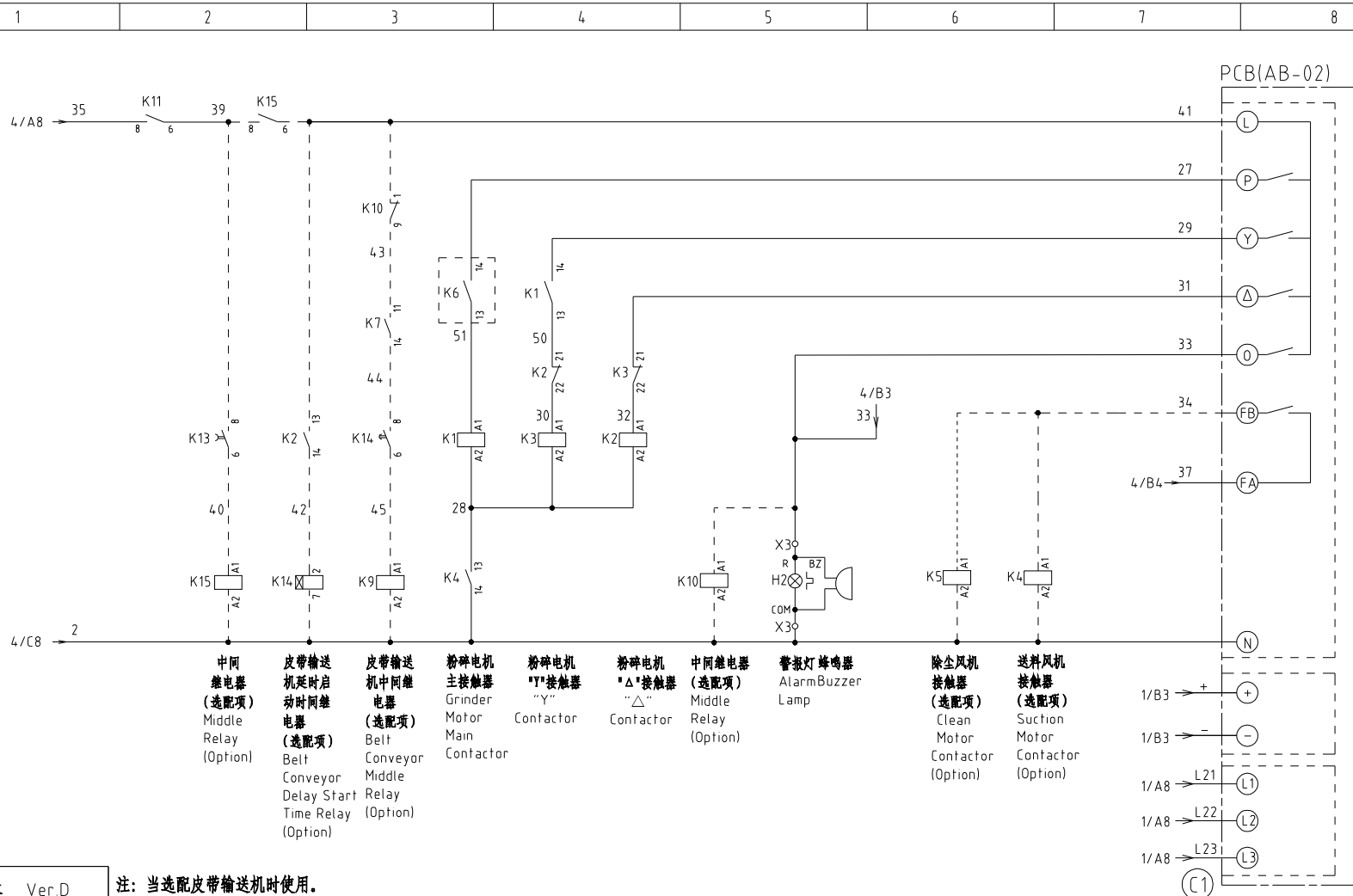

机型版本 Ver.D 注: 当选配皮带输送机时使用。

制图			版号 C			标题 SG-4390B(H) 控制电路图六		图号 SG-4390B(H)-GB-230V-C-5		比例		第 5 张	
设计			核准			信易電熱機械股份有限公司 Shini Plastics Technologies, Inc.		标准 GB		共 12 张		机器电压 3Ø230V	
校对			日期 20220805					1/B3 +		1/B3 -		1/A8 → L21 (L1)	
标记 更改前		更改后		更改人		日期		1/A8 → L23 (L3)		1/B3 0 (C1)		机器频率 50Hz	

选配皮带输送机控制触点接线示意图

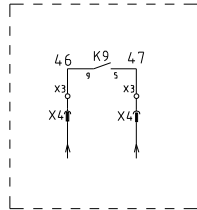

X4金属接头接线示意图
接皮带输送机
(选选项)

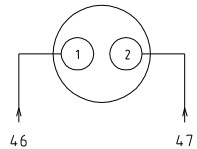

X10金属接头接线示意图
接清料报警装置
(选选项)

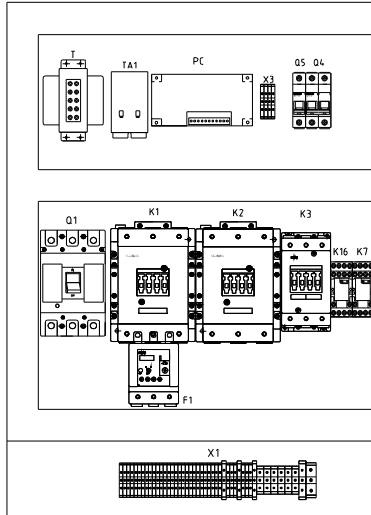
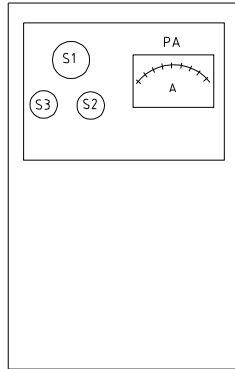
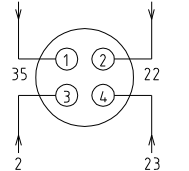

标准机型布局图

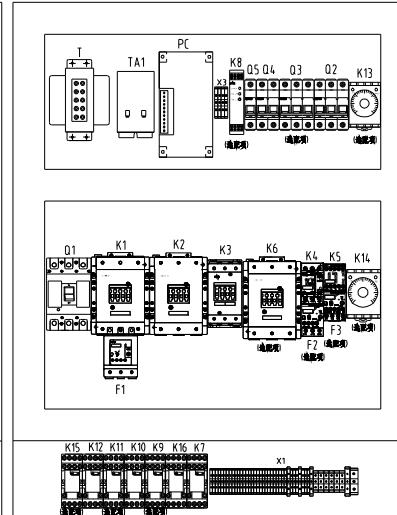

选配机型布局图

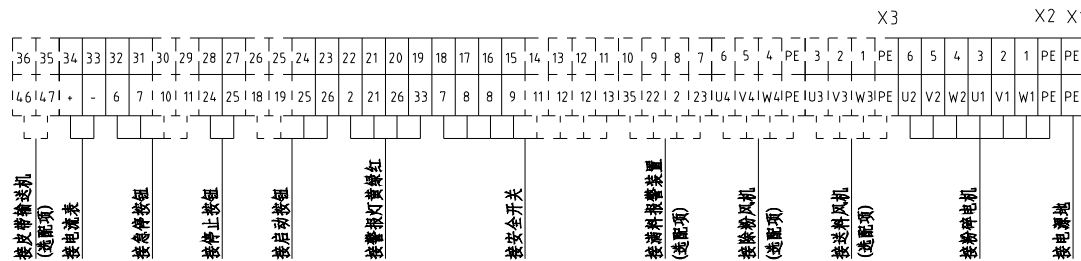

X11: 16P重载插件

①	7	⑨
②	9	⑩
③	11	⑪
④	13	⑫
⑤		⑬
⑥		⑭
⑦		⑮
⑧		⑯

注: 当不选配安全继电器时将9号端子改为21号, 11号端子和13号端子不用接

机型版本 Ver.D 注: 当不选配安全继电器时将6号端子改为3号, 9号端子改为21号。

制图	版号	C	标题	SG-4390B(H) 电气元件布置图	图号	SG-4390B(H)-GB-230V-C-6	比例	第 6 张	
设计	核准		信易電熱機械股份有限公司 Shini Plastics Technologies, Inc.	标准	GB	共 12 张	机器电压	3Ø230V	
校对	日期	20220805		标记	更改前	更改后	更改人	日期	机器频率

1		2		3		4		5		6		7		8	
序号/NO	符号/Symbol	名称/Name		制造商/Manufacturer		型号/Type		规格/Specification		数量/Number	物料编号/Material number		备注/Remark		
A	1	Q1	门连锁断路器/Gate Circuit-breaker		TECO		TAX-250L3160/3P		160A		1	YE40250300400			
	2		断路器外部操作把手/External operating handle		TECO		FB2R-CS1-C-D1x(TAX-250)		----		1	YE90211200300			
	3	Q2	断路器/Circuit-breaker		TECO		BM-63C/3020S		20A		1	YE40302003000		(7)	
	4	Q2	断路器/Circuit-breaker		TECO		BM-63C/3P		63A		1	YE40306303000		(6)	
	5	Q3	断路器/Circuit-breaker		TECO		BM-63C/3P		6A		1	YE40300603000		(2)	
	6	Q4	断路器/Circuit-breaker		TECO		BM-63C/2006S 2P		6A		1	YE40200600000			
	7	Q5	断路器/Circuit-breaker		TECO		BM-63C/1010S 1P		10A		1	YE40101000100			
B	8	K1,K2	接触器/Contactor		SIEMENS		3RT5046-1AC20		95A 24 VAC 50/60Hz		2	YE00504602600			
	9		辅助触点/Auxiliary Contactor		SIEMENS		3RH5921-1CA10		1NO		1	YE00592110000			
	10	K3	接触器/Contactor		SIEMENS		3RT5045-1AC20		80A 24 VAC 50/60Hz		1	YE00504502600			
	11		辅助触点/Auxiliary Contactor		SIEMENS		3RH5921-1CA01		1NC		2	YE00592110100			
	12		辅助触点/Auxiliary Contactor		SIEMENS		3RH5921-1CA10		1NO		1	YE00592110000		(5)	
	13		辅助触点/Auxiliary Contactor		SIEMENS		3RH5921-1CA01		1NC		1	YE00592110100		(4)	
	14	K4	接触器/Contactor		SIEMENS		3RT6017-1AB01		12A 24 VAC 50/60Hz		1	YE00601702500		(7)	
C	15	K4	接触器/Contactor		SIEMENS		3RT6027-1AC20		32A 24 VAC 50/60Hz		1	YE00602702600		(6)	
	16		辅助触点/Auxiliary Contactor		SIEMENS		3RH6911-1HA11		1NC+1NO		1	YE00691100100			
	17	K5	接触器/Contactor		SIEMENS		3RT6016-1AB02		9A 24 VAC 50/60Hz		1	YE00601602600		(2)	
	18	K6	接触器/Contactor		SIEMENS		3RT5055-6AB36		150A 24 VAC 50/60Hz		1	YE00505500600		(4)	
	19		辅助触点/Auxiliary Contactor		SIEMENS		3RH5921-1CA01		1NC		1	YE00592110100		(4)	
	20		辅助触点/Subsidiary Contactor		SIEMENS		3RH5921-1CA10		1NO		1	YE00592110000		(4)	
	21	K7	中间继电器/Middle relay		Honeywell		GR-2C-AC24V		24 VAC		1	YE03022400300			
D	22	K7	中间继电器/Middle relay		Honeywell		GR-4C-AC24V		24 VAC		1	YE03042400300		(5)	
	23	K8	安全继电器/Safety relay		PILZ		PN0Z×2 8P		24 V AC/DC		1	YE04023000000		(4)	
	24	K9 K10 K11 K15	中间继电器/Middle relay		Honeywell		GR-2C-AC24V		24 VAC		4	YE03022400300		(5)	
	25	K12	中间继电器/Middle relay		Honeywell		GR-2C-AC24V		24 VAC		1	YE03022400300		(4)	
	机型版本 Ver.D		注: (1)表示非电控箱内材料; (2)表示除尘风机选配件; (3)表示满料报警装置选配件; (4)表示安全继电器选配件; (5)表示皮带输送机选配件; (6)表示加大风机功率选配件; (7)表示送料风机选配件。 (C1)												
				制图		版号 C		标题 SG-4390B		图号		比例		第 7 张	
				设计		核准		电气元件明细一		SG-4390B(H)-GB-230V-C-7		标准 GB		共 12 张	
(C1)		标准CE		标准GB		校对		 信易電熱機械股份有限公司 Shini Plastics Technologies, Inc.		机器电压		3Ø230V			
标记 更改前		更改后		更改人		日期				20220805		机器频率		50Hz	
1		2		3		4		5		6		7		8	

1		2		3		4		5		6		7		8	
序号/NO	符号/Symbol	名称/Name		制造商/Manufacturer		型号/Type		规格/Specification		数量/Number		物料编号/Material number		备注/Remark	
26	K13	定时器/Timer		YUYUN		TRF-N/3M		24VAC		1		YE86032400000		(5)	
27	K14	定时器/Timer		YUYUN		TH3A-NAB 60S		24VAC		1		YE86602400300		(5)	
28	F1	热过载继电器/Overload relay		SIEMENS		3RU5146-4KB0		57-75A		1		YE01514650000			
29	F2	热过载继电器/Overload relay		SIEMENS		3RU6116-1JB0		7-10A		1		YE01167100000		(7)	
30	F2	热过载继电器/Overload relay		SIEMENS		3RU6126-4EB0		27-32A		1		YE01612600600		(6)	
31	F3	热过载继电器/Overload relay		SIEMENS		3RU1116-1EB0		2.8-4A		1		YE01160280000		(2)	
32	K16	中间继电器/Middle relay		Honeywell		GR-2C-AC24V		24VAC		1		YE03022400300			
33	S1	急停按钮/Emergency stop button		SCHNEIDER		XB2BS542C		400VAC		1		YE11254200000		(1)	
34		触点块/Contact block		SCHNEIDER		ZB2BE102C		1NC		1		YE00210203100		(1)(4)	
35	S2	停止按钮/Stop button		SCHNEIDER		XB2BA22C		400VAC		1		YE11222000000		(1)	
36	S3,H1	启动按钮(带灯)/Start button		SCHNEIDER		XB2BW33B1C		24VAC		1		YE11233100000		(1)	
37		触点块/Contact block		SCHNEIDER		ZB2BE101C		1NO		1		YE00210103100		(1)(4)	
38	S4,S5	安全开关/Safety switch		SCHMERSRC		AZ16-02ZVRK-1476		230VAC		2		YE16147600000		(1)(4)	
39	S4,S5	安全开关/Safety switch		SCHMERSRC		AZ15-02ZVRK-1476		230VAC		2		YE16147600100		(1)	
40	H2	三色警报灯/Alarm lamp		SHINI		红绿黄优先顺序+蜂鸣器		24VAC/DC 50/60Hz		1		BL90002401520		(1)	
41	H3	蜂鸣器/Buzzer		TEND		EA-2		24VAC		1		YE84240200000		(1)(3)	
42	MS	料位马达/Feed position motor		SHINI		SR-80		24VAC		1		YE15802400100		(1)(3)	
43	T	互感器/Transformer		----		IN=230/200V OUT=24VAC		300VA		1		YE70023005000			
44	TA1	电流互感器/Current mutual inductance		RATIO		RQT-35		100/5A		1		YE04100500000			
45	PA	电流表/Galvanometry		SFIM		DH-670		100/5A		1		YE25671000000		(1)	
46	PCB	微电脑板/PCB		YUYUN		AB-02		24VAC		1		YE80022400100			
47		塑膠外壳SI-4T線路板用		----		----		----		1		YR40000400100			
48	TA2	电流互感器/Current mutual inductance		YUYUN		----		5-100A		1		----		线路板自带	
49	X1	端子排/Terminal		Honeywell		GK35PE		35mm ² PE		1		YE60003503500			
50	X2	端子排/Terminal		Honeywell		GK35		35mm ²		6		YE60003503200			
机型版本 Ver.D		注: (1)表示非电控箱内材料; (2)表示除尘风机选配件; (3)表示满料报警装置选配件; (4)表示安全继电器选配件; (5)表示皮带输送机选配件; (6)表示加大风机功率选配件; (7)表示送料风机选配件。 (C1)													
D				制图		版号 C		标题 SG-4390B		图号		比例		第 8 张	
				设计		核准		电气元件明细二		SG-4390B(H)-GB-230V-C-8		标准 GB		共 12 张	
(C1)		标准CE		标准GB		校对		 信易電熱機械股份有限公司 Shini Plastics Technologies, Inc.		机器电压		3Ø230V			
标记		更改前		更改后		更改人				日期		20220805		机器频率	
1		2		3		4		5		6		7		8	

1	2	3	4	5	6	7	8		
序号/NO	符号/Symbol	名称/Name	制造商/Manufacturer	型号/Type	规格/Specification	数量/Number	物料编号/Material number	备注/Remark	
51		端子排/Terminal	Honeywell	GK16PE	16mm ² PE	1	YE60001603500		
52	X3	端子排/Terminal	Honeywell	SK2.5	2.5mm ²	21	YE60002503200		
53			Honeywell	GK2.5PE	2.5mm ² PE	1	YE60002503400		
54			Honeywell	SK2.5	2.5mm ²	5	YE60002503200	(2)	
55			Honeywell	GK2.5PE	2.5mm ² PE	1	YE60002503400	(2)	
56			Honeywell	SK2.5	2.5mm ²	4	YE60002503200	(3)	
57			Honeywell	SK2.5	2.5mm ²	2	YE60002503200	(5)	
58			Honeywell	SK2.5	2.5mm ²	8	YE60002503200	(4)	
59			Honeywell	SK6	6mm ²	3	YE60000603200	(6)	
60			Honeywell	SK6PE	6mm ² PE	1	YE60000603500	(6)	
61		终端固定件E/GX系列	Honeywell		PCS	4	YE60000003900		
62	X4	金属接头/Metal tie in	SHINI	PLT-162-RR(公)	2P	1	YE68016200100	(1)(5)	
63	X10	金属接头/Metal tie in	SHINI	PLT-254-PM	4P	1	YE68025400000	(1)(3)	
64		金属接头/Metal tie in	----	PLT-254-RF	4P	1	YE68025400100	(1)(3)	
65	X11	重载插件件/Heavy duty connector	HARTING	16P+PE(公插-母座)	16P	1	YE68001601300	(1)	
66	M1	粉碎电机/Granulating motor	----	----	230V 50Hz 37kW	1	----	(1)	
67	M2	送料风车/Solution blower	----	----	230V 50Hz 2.2kW	1	----	(1)	
68	M2	送料风车/Solution blower	----	----	230V 50Hz 7.5kW	1	----	(1)(6)	
69	M3	除尘风车/Dust blower	----	----	230V 50Hz 0.75kW	1	----	(1)(2)	
机型版本 Ver.D 注: (1)表示非电控箱内材料; (2)表示除尘风机选配件; (3)表示满料报警装置选配件; (4)表示安全继电器选配件; (5)表示皮带输送机选配件; (6)表示加大风机功率选配件; (7)表示送料风机选配件。 (C1)									
			制图	版号	C	标题	图号	比例	第 9 张
			设计	核准		SG-4390B	SG-4390B(H)-GB-230V-C-9	标准	GB
			校对	核准		电气元件明细三		机器电压	3Ø230V
(C1)	标准CE	标准GB	校对	核准		 信易電熱機械股份有限公司 Shini Plastics Technologies, Inc.	机器频率	50Hz	
标记	更改前	更改后	更改人	日期	审核		日期	20220805	

1		2		3		4		5		6		7		8	
序号/NO	符号/Symbol	名称/Name		制造商/Manufacturer		型号/Type		规格/Specification		数量/Number	物料编号/Material number		备注/Remark		
A	1	Q1	门连锁断路器/Gate Circuit-breaker		TECO		TAX-250L3200 / 3P		200A		1	YE40250300500			
	2		断路器外部操作把手/External operating handle		TECO		FB2R-CS1-C-D1x(TAX-250)		----		1	YE90211200300			
	3	Q2	断路器/Circuit-breaker		TECO		BM-63C/3020S		20A		1	YE40302003000		(7)	
	4	Q2	断路器/Circuit-breaker		TECO		BM-63C/3P		63A		1	YE40306303000		(6)	
	5	Q3	断路器/Circuit-breaker		TECO		BM-63C/3010S		10A		1	YE40301003000		(2)	
	6	Q4	断路器/Circuit-breaker		TECO		BM-63C/2006S 2P		6A		1	YE40200600000			
	7	Q5	断路器/Circuit-breaker		TECO		BM-63C/1010S 1P		10A		1	YE40101000100			
B	8	K1,K2	接触器/Contactor		SIEMENS		3RT5054-1AB36		115A 24VAC 50/60Hz		2	YE00505400900			
	9		辅助触点/Auxiliary Contactor		SIEMENS		3RH5921-1CA01		1NC		1	YE00592110100		(4)	
	10		辅助触点/Auxiliary Contactor		SIEMENS		3RH5921-1CA01		1NC		1	YE00592110100			
	11		辅助触点/Auxiliary Contactor		SIEMENS		3RH5921-1CA10		1NO		1	YE00592110000		(5)	
	12		辅助触点/Auxiliary Contactor		SIEMENS		3RH5921-1CA10		1NO		1	YE00592110000			
	13	K3	接触器/Contactor		SIEMENS		3RT5046-1AC20		95A 24VAC 50/60Hz		1	YE00504602600			
	14	K4	接触器/Contactor		SIEMENS		3RT6017-1AB01		12A 24VAC 50/60Hz		1	YE00601702500		(7)	
C	15	K4	接触器/Contactor		SIEMENS		3RT6028-1AC20		38A 24VAC 50/60Hz		1	YE00602802600		(6)	
	16		辅助触点/Auxiliary Contactor		SIEMENS		3RH6911-1HA11		1NC+1NO		1	YE00691100100			
	17	K5	接触器/Contactor		SIEMENS		3RT6016-1AB02		9A 24VAC 50/60Hz		1	YE00601602600		(2)	
	18	K6	接触器/Contactor		SIEMENS		3RT5056-6AB36		185A 24VAC 50/60Hz		1	YE00505600300		(4)	
	19		辅助触点/Auxiliary Contactor		SIEMENS		3RH5921-1CA01		1NC		1	YE00592110100		(4)	
	20		辅助触点/Subsidiary Contactor		SIEMENS		3RH5921-1CA10		1NO		1	YE00592110000		(4)	
	21	K7	中间继电器/Middle relay		Honeywell		GR-2C-AC24V		24VAC		1	YE03022400300			
D	22	K7	中间继电器/Middle relay		Honeywell		GR-4C-AC24V		24VAC		1	YE03042400300		(5)	
	23	K8	安全继电器/Safety relay		PILZ		PN0Z×2.8P		24V AC/DC		1	YE04023000000		(4)	
	24	T	互感变压器/Transformer		----		IN=230/200V OUT=24VAC		300VA		1	YE70023005000			
	25	K9 K10 K11 K15	中间继电器/Middle relay		Honeywell		GR-2C-AC24V		24VAC		4	YE03022400300		(5)	
	机型版本 Ver.D		注: (1)表示非电控箱内材料; (2)表示除尘马达选配件; (3)表示满料报警装置选配件; (4)表示安全继电器选配件; (5)表示皮带输送机选配件; (6)表示加大风机功率选配件; (7)表示送料风机选配件。 (C1)												
				制图		版号 C		标题 SG-4390BH		图号 SG-4390B(H)-GB-230V-C-10		比例		第 10 张	
				设计		核准		电气元件明细一				标准 GB		共 12 张	
(C1)		标准CE		标准GB		校对		 信易電熱機械股份有限公司 Shini Plastics Technologies, Inc.		机器电压		3Ø230V			
标记 更改前		更改后		更改人		日期				20220805		机器频率		50Hz	
1		2		3		4		5		6		7		8	

1	2	3	4	5	6	7	8	
序号/NO	符号/Symbol	名称/Name	制造商/Manufacturer	型号/Type	规格/Specification	数量/Number	物料编号/Material number	备注/Remark
26	K12	中间继电器/Middle relay	Honeywell	GR-2C-AC24V	24VAC	1	YE03022400300	(4)
27	K13	定时器/Timer	YUYUN	TRF-N/3M	24VAC	1	YE86032400000	(5)
28	K14	定时器/Timer	YUYUN	TH3A-NAB 60S	24VAC	1	YE86602400300	(5)
29	F1	热过载继电器/Overload relay	SIEMENS	3RU5146-4MB0	80-100A	1	YE01514680000	
30		S3独立安装底座	SIEMENS	3RU5946-3AA01	S3	1	YE01594600000	
31	F2	热过载继电器/Overload relay	SIEMENS	3RU6116-1JB0	7-10A	1	YE01167100000	(7)
32	F2	热过载继电器/Overload relay	SIEMENS	3RU6126-4EB0	27-32A	1	YE01612600600	(6)
33	F3	热过载继电器/Overload relay	SIEMENS	3RU1116-1EB0	2.8-4A	1	YE01160280000	(2)
34	K16	中间继电器/Middle relay	Honeywell	GR-2C-AC24V	24VAC	1	YE03022400300	
35	S1	急停按钮/Emergency stop button	SCHNEIDER	XB2BS542C	400VAC	1	YE11254200000	(1)
36		触点块/Contact block	SCHNEIDER	ZB2BE102C	1NC	1	YE00210203100	(1)(4)
37	S2	停止按钮/Stop button	SCHNEIDER	XB2BA22C	400VAC	1	YE11222000000	(1)
38	S3,H1	启动按钮(带灯)/Start button	SCHNEIDER	XB2BW33B1C	24VAC	1	YE11233100000	(1)
39		触点块/Contact block	SCHNEIDER	ZB2BE101C	1NO	1	YE00210103100	(1)(4)
40	S4,S5	安全开关/Safety switch	SCHMERSRC	AZ15-02ZVRK-1476	24VAC	2	YE16147600100	(1)
41	S4,S5	安全开关/Safety switch	SCHMERSRC	AZ16-02ZVRK-1476	24VAC	2	YE16147600000	(1)(4)
42	H2	三色警报灯/Alarm lamp	SHINI	红绿黄优先顺序+蜂鸣器	24VAC/DC 50/60Hz	1	BL90002401520	(1)
43	H3	蜂鸣器/Buzzer	TEND	EA-2	24VAC	1	YE84240200000	(1)(3)
44	MS	料位马达/Feed position motor	SHINI	SR-80	24VAC	1	YE15802400100	(1)(3)
45	X1	端子排/Terminal	Honeywell	GK35PE	35mm ² PE	1	YE60003503500	
46	X2	端子排/Terminal	Honeywell	GK35	35mm ²	6	YE60003503200	
47			Honeywell	GK16PE	16mm ² PE	1	YE60001603500	
48	X3	端子排/Terminal	Honeywell	SK2.5	2.5mm ²	21	YE60002503200	
49			Honeywell	GK2.5PE	2.5mm ² PE	1	YE60002503400	
50			Honeywell	SK2.5	2.5mm ²	5	YE60002503200	(2)
机型版本 Ver.D		注: (1)表示非电控箱内材料; (2)表示除尘马达选配件; (3)表示满料报警装置选配件; (4)表示安全继电器选配件; (5)表示皮带输送机选配件; (6)表示加大风机功率选配件; (7)表示送料风机选配件。 (C1)						
		制图		版号 C	标题 SG-4390BH	图号 SG-4390B(H)-GB-230V-C-11	比例	第 11 张
		设计		核 准	电气元件明细二		标准 GB	共 12 张
(C1) 标准CE		标准GB		校 对	 信易電熱機械股份有限公司 Shini Plastics Technologies, Inc.		机器电压	3Ø230V
标记 更改前		更改后		日 期			20220805	机器频率
1	2	3	4	5	6	7	8	

1	2	3	4	5	6	7	8		
序号/NO	符号/Symbol	名称/Name	制造商/Manufacturer	型号/Type	规格/Specification	数量/Number	物料编号/Material number	备注/Remark	
51			Honeywell	GK2.5PE	2.5mm ² PE	1	YE60002503400	(2)	
52			Honeywell	SK2.5	2.5mm ²	4	YE60002503200	(3)	
53			Honeywell	SK2.5	2.5mm ²	2	YE60002503200	(5)	
54			Honeywell	SK2.5	2.5mm ²	8	YE60002503200	(4)	
55			Honeywell	SK6	6mm ²	3	YE60000603200	(6)	
56			Honeywell	SK6PE	6mm ² PE	1	YE60000603500	(6)	
57		终端固定件E/GK系列	Honeywell	----	PCS	4	YE60000003900		
58	X4	金属接头/Metal tie in	SHINI	PLT-162-RR(公)	2P	1	YE68016200100	(1)(5)	
59	X10	金属接头/Metal tie in	SHINI	PLT-254-PM	4P	1	YE68025400000	(1)(3)	
60		金属接头/Metal tie in	SHINI	PLT-254-RF	4P	1	YE68025400100	(1)(3)	
61	X11	重载接插件/Heavy duty connector	HARTING	16P+PE(公插+母座)	16P	1	YE68001601300	(1)	
62	PCB	微电脑板/PCB	YUYUN	AB-02	24VAC	1	YE80022400100		
63		塑膠外殼SI-4T線路板用	----	----	----	1	YR40000400100		
64	PA	电流表/Galvanometry	SFIM	DH-670	100/5A	1	YE25671000000	(1)	
65	TA1	电流互感器/Current mutual inductance	RATIO	RQT-10	100/5A	1	YE04100500000		
66	TA2	电流互感器/Current mutual inductance	YUYUN	----	5-100A	1	----	线路板自带	
67	M1	粉碎电机/Granulating motor	----	----	230V 50Hz 30kW	1	----	(1)	
68	M2	送料风车/Solution blower	----	----	230V 50Hz 2.2kW	1	----	(1)	
69	M2	送料风车/Solution blower	----	----	230V 50Hz 7.5kW	1	----	(1)(6)	
70	M3	除尘风车/Dust blower	----	----	230V 50Hz 0.75kW	1	----	(1)(2)	
机型版本 Ver.D 注: (1)表示非电控箱内材料; (2)表示除尘马达选配件; (3)表示满料报警装置选配件; (4)表示安全继电器选配件; (5)表示皮带输送机选配件; (6)表示加大风机功率选配件; (7)表示送料风机选配件。 (C1)									
			制图	版号	C	标题	图号	比例	第 12 张
			设计	核准		SG-4390BH	SG-4390B(H)-GB-230V-C-12	标准	GB
			校对	核准		电气元件明细三		机器电压	3Ø230V
(C1)	标准CE	标准GB	校对	核准		 信易電熱機械股份有限公司 Shini Plastics Technologies, Inc.	机器频率	50Hz	
标记	更改前	更改后	更改人	日期	审核		日期	20220805	