

机型版本 Ver.C

					Drawer	Version	B
					Designer	Approved by	
					Proofread by	Date	20210615
Mark	Before modification	After modification	Modified by	Modify date	Checked by		

Title	SG-2436T 主电路图	Drawing NO.	SG-2436T-CE-230V-B-1
 <b>信易电热机械股份有限公司</b> <b>Shini Plastics Technologies, Inc.</b>		Scale	Page 1
		Standard	CE
		Voltage	3φ230V
		Frequency	50Hz

Scale	Page 1
Standard	Totally 6 Pages
Voltage	3φ230V
Frequency	50Hz

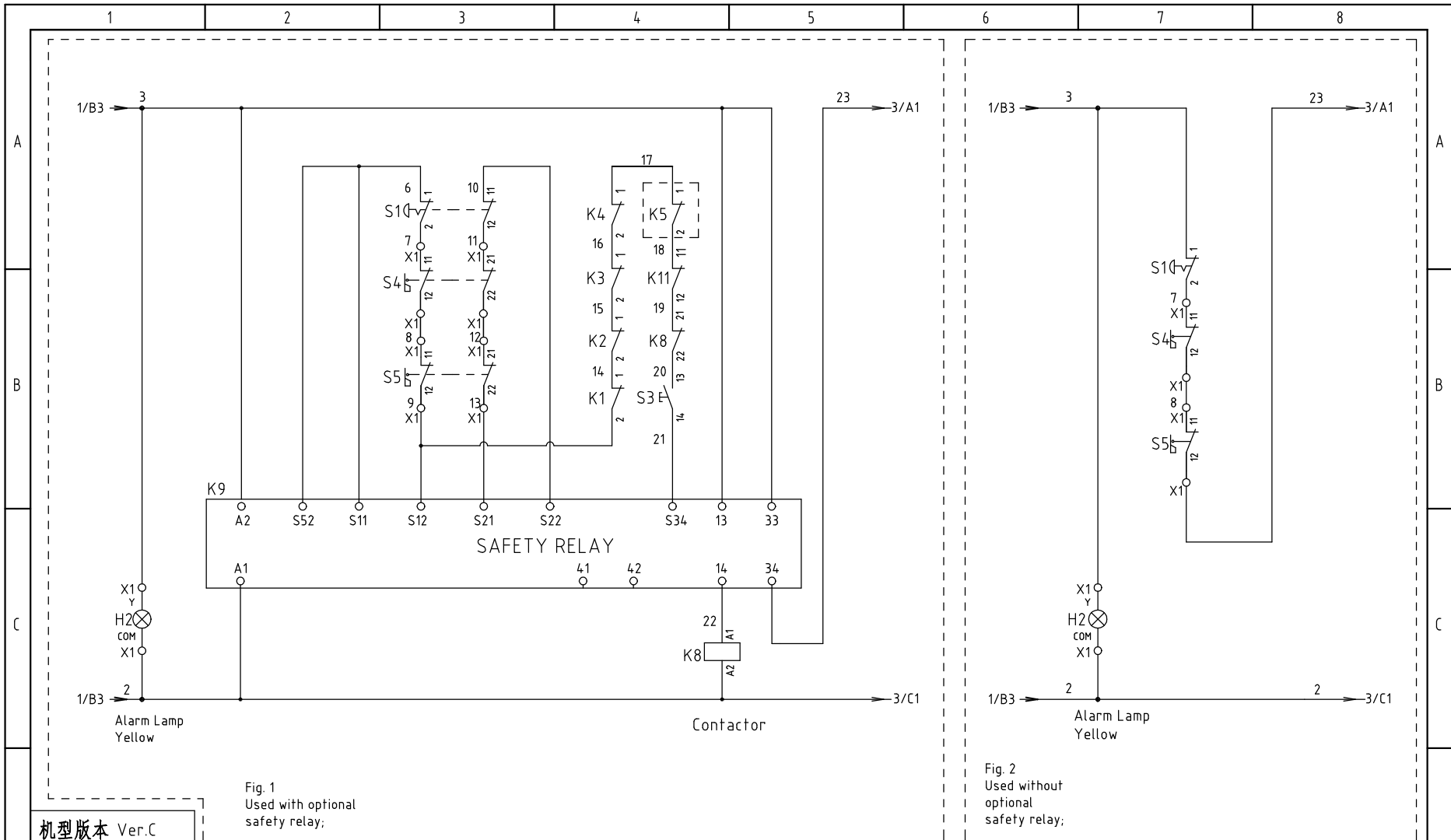

机型版本 Ver.C

					Drawer		Version	B
					Designer		Approved by	
					Proofread by		Checked by	
Mark	Before modification	After modification	Modified by	Modify date	Checked by		Date	20210615

Title  
SG-2436T  
控制电路图一

Drawing NO.  
SG-2436T-CE-230V-B-2

Scale	Page 2
Standard	Totally 6 Pages

**SHINI** 信易電熱機械股份有限公司  
Shini Plastics Technologies, Inc.

Voltage	3φ230V
Frequency	50Hz

1 2 3 4 5 6 7 8

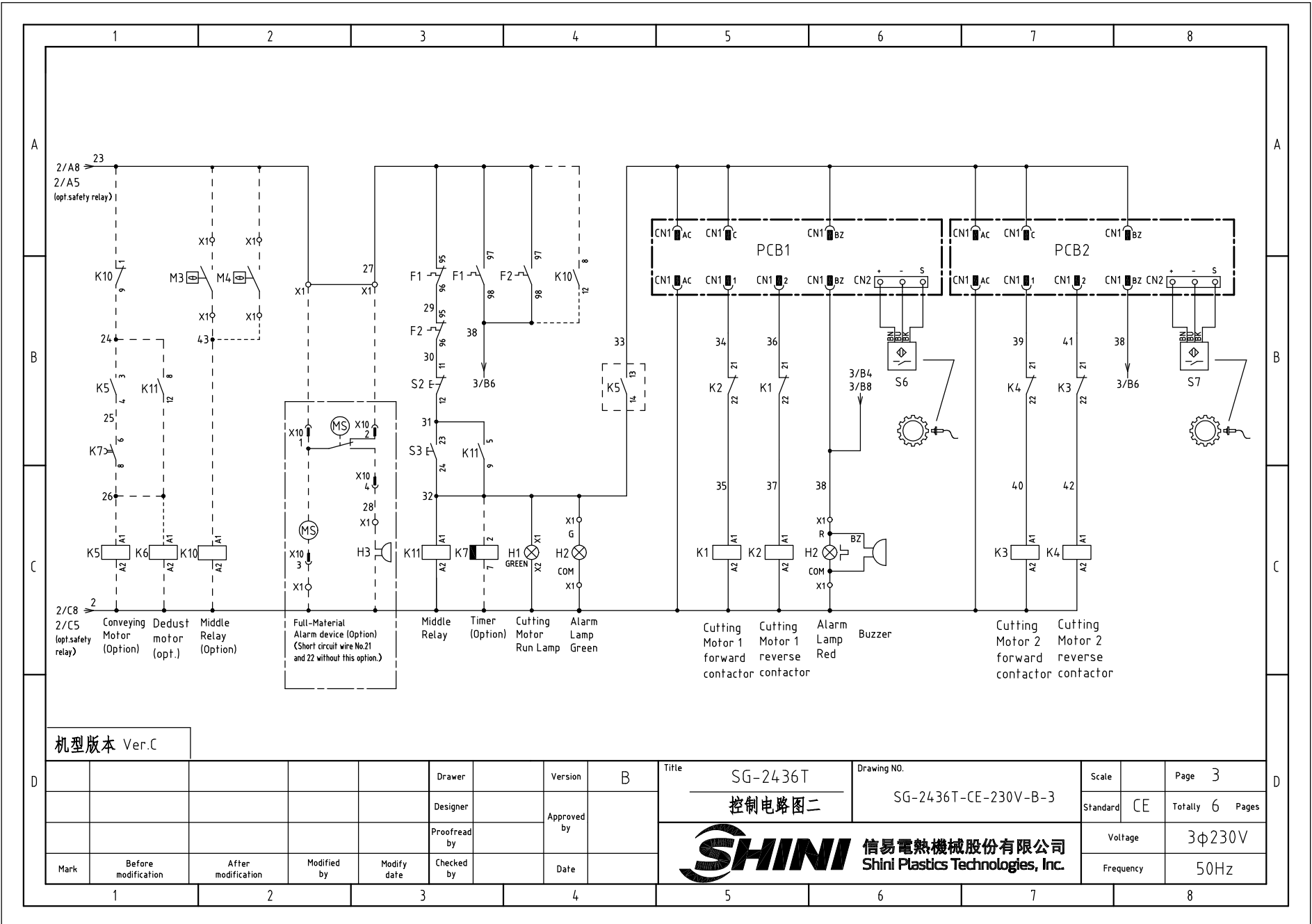

机型版本 Ver.C

D	Drawer	Version	B	Title SG-2436T 控制电路图二	Drawing NO. SG-2436T-CE-230V-B-3	Scale	Page	3	
	Designer	Approved by				Standard	CE	Totally	6 Pages
	Proofread by	Date				Voltage	3φ230V		
	Mark	Before modification	After modification			Modified by	Modify date	Checked by	Frequency



1      2      3      4      5      6      7      8

1 2 3 4 5 6 7 8

A

B

C

D

A

B

C

D

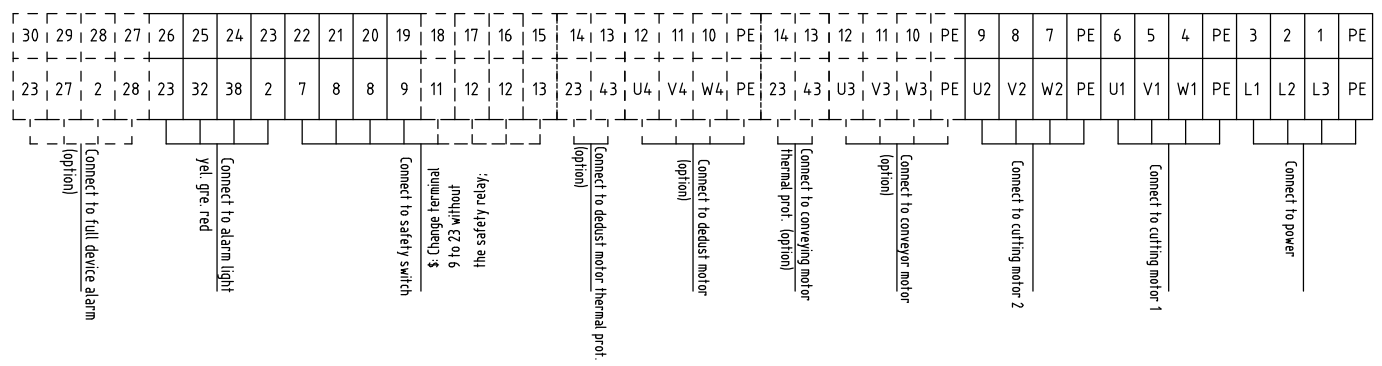
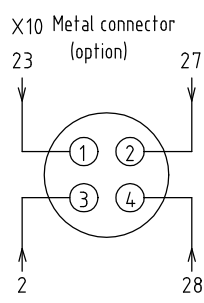
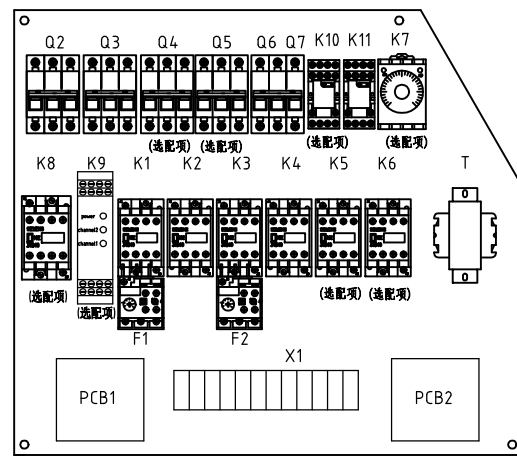
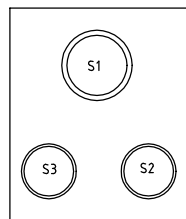

机型版本 Ver.C

Mark	Before modification	After modification	Modified by	Modify date	Checked by	Date	Version	Approved by
							SG-2436T	
							Designer	
							Proofread by	
							Drawer	

Title SG-2436T  
电气元件布置图

Drawing NO. SG-2436T-CE-230V-B-4

Scale	Page 4
Standard CE	Totally 6 Pages
Voltage	3φ230V
Frequency	50Hz



1 2 3 4 5 6 7 8

1		2		3		4		5		6		7		8	
NO.	Symbol	Name		Manufacturer		Type		Specification		Number	Material number		Remark		
1	Q1	Main power switch		MOELLER		P1-25/EA/SVB		25A		1	YE10125250000		(1)		
2	Q2 Q3	Circuit breaker		TECO		BM-63C/3020S		20A		2	YE40302003000				
3	Q4	Circuit breaker		TECO		BM-63C/3P		6A		1	YE40300603000		(2)		
4	Q5	Circuit breaker		TECO		BM-63C/3P		6A		1	YE40300603000		(3) New		
5	Q6	Circuit breaker		TECO		BM-63C/2003S 2P		3A		1	YE40200203000				
6	Q7	Circuit breaker		TECO		BM-63C/1003S 1P		3A		1	YE40100203000				
7	K1 K2 K3 K4	Contactor		SIEMENS		3RT6018-1AB02		24 VAC 50/60Hz		4	YE00601802600				
8		Auxiliary contact		SIEMENS		3RH6911-1HA11		1NC+1NO		4	YE00691100100		(5)		
9	K5	接触器/Contactors		SIEMENS		3RT6016-1AB01		24 VAC 50/60Hz		1	YE00601602500		(2) Cancel		
10	K5	Contactors		SIEMENS		3RT6015-1AB01		24 VAC 50/60Hz		1	YE00601502500		(2) New		
11		Auxiliary contact		SIEMENS		3RH6911-1HA11		1NC+1NO		1	YE00691100100		(2)		
12	K6	Contactors		SIEMENS		3RT6015-1AB01		24 VAC 50/60Hz		1	YE00601502500		(3) New		
13	K7	Timer relay		YUYUN		TRF-N		24 VAC		1	YE86032400000		(2)(3) New		
14	K8	Contactor		SIEMENS		3RT6027-1AC20		24 VAC 50/60Hz		1	YE00602702600		(5)		
15	K9	Safety relay		PILZ		PNOZ X2.8P		24 VAC/DC		1	YE04023000000		(5)		
16	K10	Middle relay		HoneyWell		GR-2C-AC24V		24 VAC		1	YE03022400300		(2)(3) New		
17	K11	Middle relay		HoneyWell		GR-4C-AC24V		24 VAC		1	YE03042400300				
18	F1 F2	Thermal overload relay		SIEMENS		3RU6116-1JB0		7-10A		2	YE01167100000				
19	T	Transformer		BAIYUN		IN=230V/200V OUT=24V		80VA		1	YE70023005200				
20	PCB1 PCB2	Microcomputer/PCB		YUYUN		AC-01		24 VAC		2	YE80012400600				
21	X1	Terminal board		HoneyWell		SK2.5		2.5mm <sup>2</sup>		17	YE60002503200				
22				HoneyWell		GK2.5 PE		2.5mm <sup>2</sup> PE		3	YE60002503400				
23				HoneyWell		SK2.5		2.5mm <sup>2</sup>		5	YE60002503200		(2)		
24				HoneyWell		GK2.5 PE		2.5mm <sup>2</sup> PE		1	YE60002503400		(2)		
25				HoneyWell		SK2.5		2.5mm <sup>2</sup>		5	YE60002503200		(3) New		
机型版本 Ver.C		Notes:(1)Materials not in the control box;(2)Conveying blower assembly;(3)Dedust blower assembly;(4) Full- material alarm options; (5) Safety relay options;													
				Drawer		Version		Title SG-2436T		Drawing NO.		Scale		Page 5	
				Designer		Approved by		电气元件明细表一		SG-2436T-CE-230V-B-5		Standard CE		Totally 6 Pages	
				Proofread by		Date		 <b>信易電熱機械股份有限公司</b> <b>Shini Plastics Technologies, Inc.</b>		Voltage		3φ230V			
Mark		Before modification		After modification		Modified by				Modify date		Checked by		Frequency 50Hz	
1		2		3		4		5		6		7		8	

1		2		3		4		5		6		7		8			
NO.	Symbol	Name			Manufacturer	Type		Specification		Number	Material number		Remark				
A	26				HoneyWell	GK2.5 PE		2.5mm <sup>2</sup> PE		1	YE60002503400		(3) New				
	27				HoneyWell	SK2.5		2.5mm <sup>2</sup>		4	YE60002503200		(4)				
	28				HoneyWell	SK2.5		2.5mm <sup>2</sup>		4	YE60002503200		(5)				
	29	X10	Metal connector			SHINI	254-P/R公		250V 4P		1	YE68025400000		(1)(4)			
	30				SHINI	254-P/R母		250V 4P		1	YE68025400100		(1)(4)				
	31	S1	Emergency stop button			SCHNEIDER	XB2BS542C		230VAC		1	YE11254200000		(1)			
	32		Contact block			SCHNEIDER	ZB2BE102C		1NC		1	YE00210203100		(1)(5)			
	B	33	S2	Stop button			SCHNEIDER	XB2BA22C		230VAC		1	YE11222000000		(1)		
34		S3 H1	Start button			SCHNEIDER	XB2BW33B1C		24 VAC		1	YE11233100000		(1)			
35			Contact block			SCHNEIDER	ZB2BE101C		1NO		1	YE00210103100		(1)(5)			
36		S4 S5	Safety switch			SCHMERSAL	AZ 152VK-1476		AC-15		2	YE16147600100		(1)			
37		S4 S5	Safety switch			SCHMERSAL	AZ16-02ZVRK-M16-1476-1		250V 3A		2	YE16147600000		(1)(5)			
38		S6 S7	Sensor			DELING	DL-12		24VDC NPN		2	YE15122400000		(1)			
39		H2	3-color alarm light			SHINI	Red. gre. yel.+buzzer		24 VAC		1	BL90002401520		(1)			
40		H3	Buzzer			TEND	EA-2		24 VAC		1	YE84240200000		(1)(4)			
C	41	MS	Level sensor			SIPAI	SR-80		24 VAC 50/60Hz		1	YE15802400100		(1)(4)			
	42	M1 M2	Cutting motor			SEW	2.2kW		230V 50Hz		2	-----		(1)			
	43	M3	Conveying motor			SHINI	0.55kW		230V 50Hz		1	-----		(1)(2)			
	44	M4	Dedust blower			SHINI	0.12kW		230V 50Hz		1	-----		(1)(3) New			
D	机型版本 Ver.C		Notes:(1)Materials not inthe control box;(2)Conveying blower assembly;(3)Dedust blower assembly;(4) Full- material alarm options; (5) Safety relay options;														
					Drawer		Version		Title	SG-2436T		Drawing NO.		Scale		Page	6
					Designer		Approved by		电气元件明细表二		SG-2436T-CE-230V-B-6		Standard	CE	Totally	6	Pages
					Proofread by		Date		 <b>信易電熱機械股份有限公司</b> <b>Shini Plastics Technologies, Inc.</b>		Voltage		3φ230V				
Mark	Before modification	After modification	Modified by	Modify date	Checked by			Frequency			50Hz						
1		2		3		4		5		6		7		8			

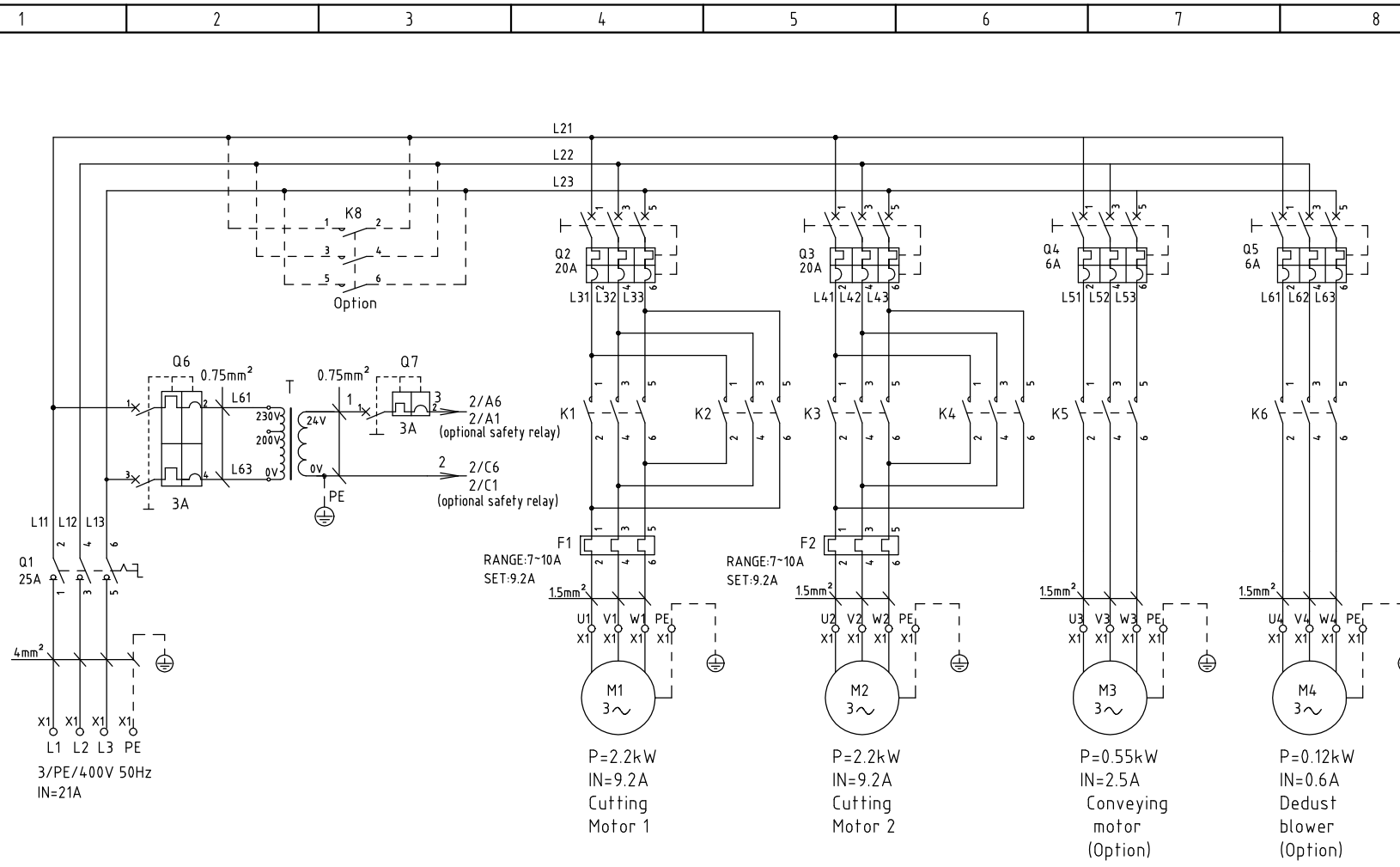

机型版本 Ver.C

D					Drawer		Version	B	Title	SG-2446T	Drawing NO.	SG-2446T-CE-230V-B-1	Scale		Page	1
					Designer		Approved by		主电路图			Standard	CE	Totally	6	Pages
					Proofread by		Date	20210615	 <b>信易电热机械股份有限公司</b> Shini Plastics Technologies, Inc.	Voltage	3φ230V					
	Mark	Before modification	After modification	Modified by	Modify date	Checked by				Frequency	50Hz					

1                      2                      3                      4                      5                      6                      7                      8

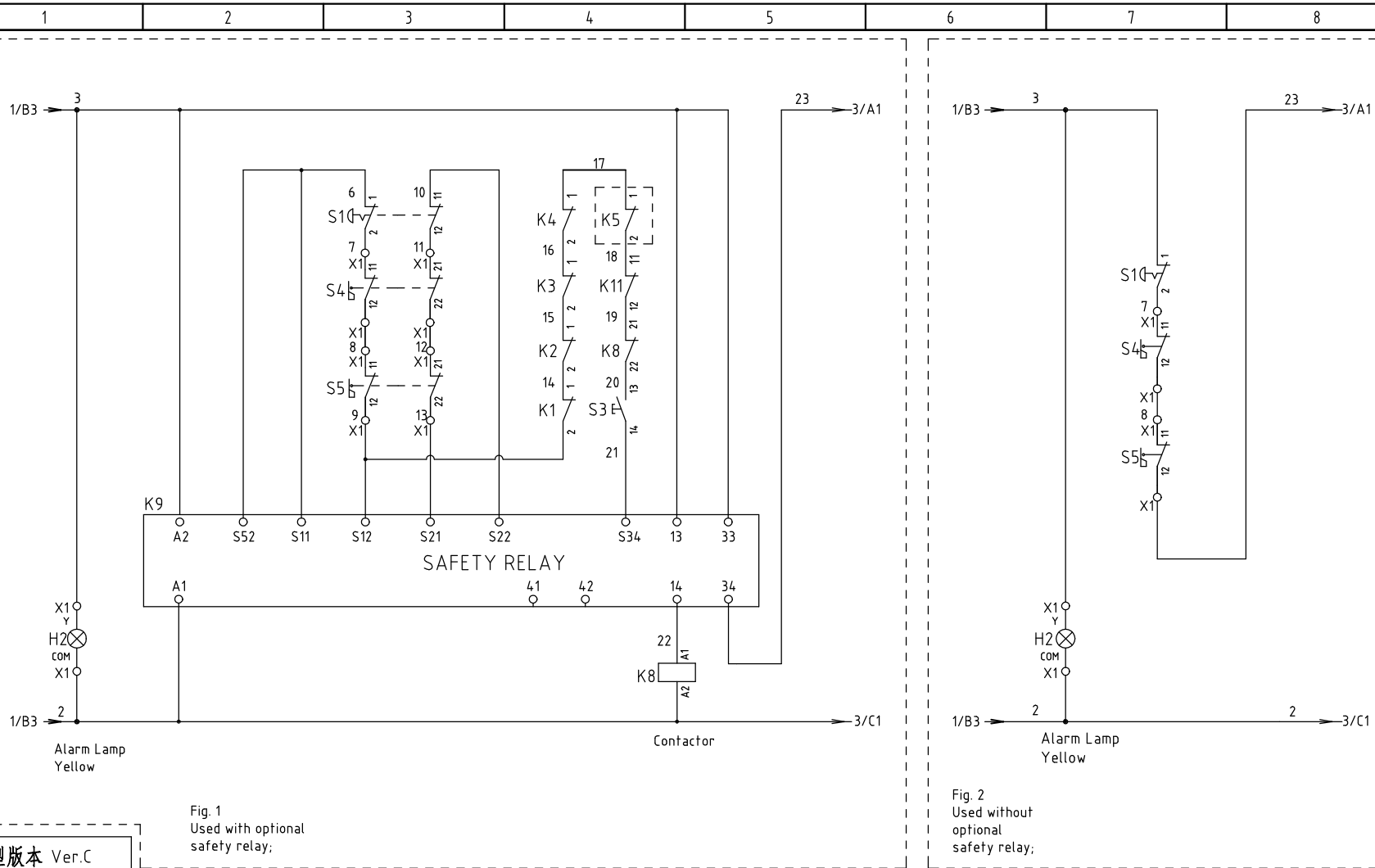

Fig. 1  
Used with optional  
safety relay;

Fig. 2  
Used without  
optional  
safety relay;

机型版本 Ver.C

Mark	Before modification	After modification	Modified by	Modify date	Checked by	Date	20210615
Designer					Proofread by	Approved by	
Drawer						Version	B

Title SG-2446T  
控制电路图一

Drawing NO. SG-2446T-CE-230V-B-2

Scale	Page 2
Standard	CE
Totally	6 Pages

**SHINI** 信易電熱機械股份有限公司  
Shini Plastics Technologies, Inc.

Voltage	3φ230V
Frequency	50Hz



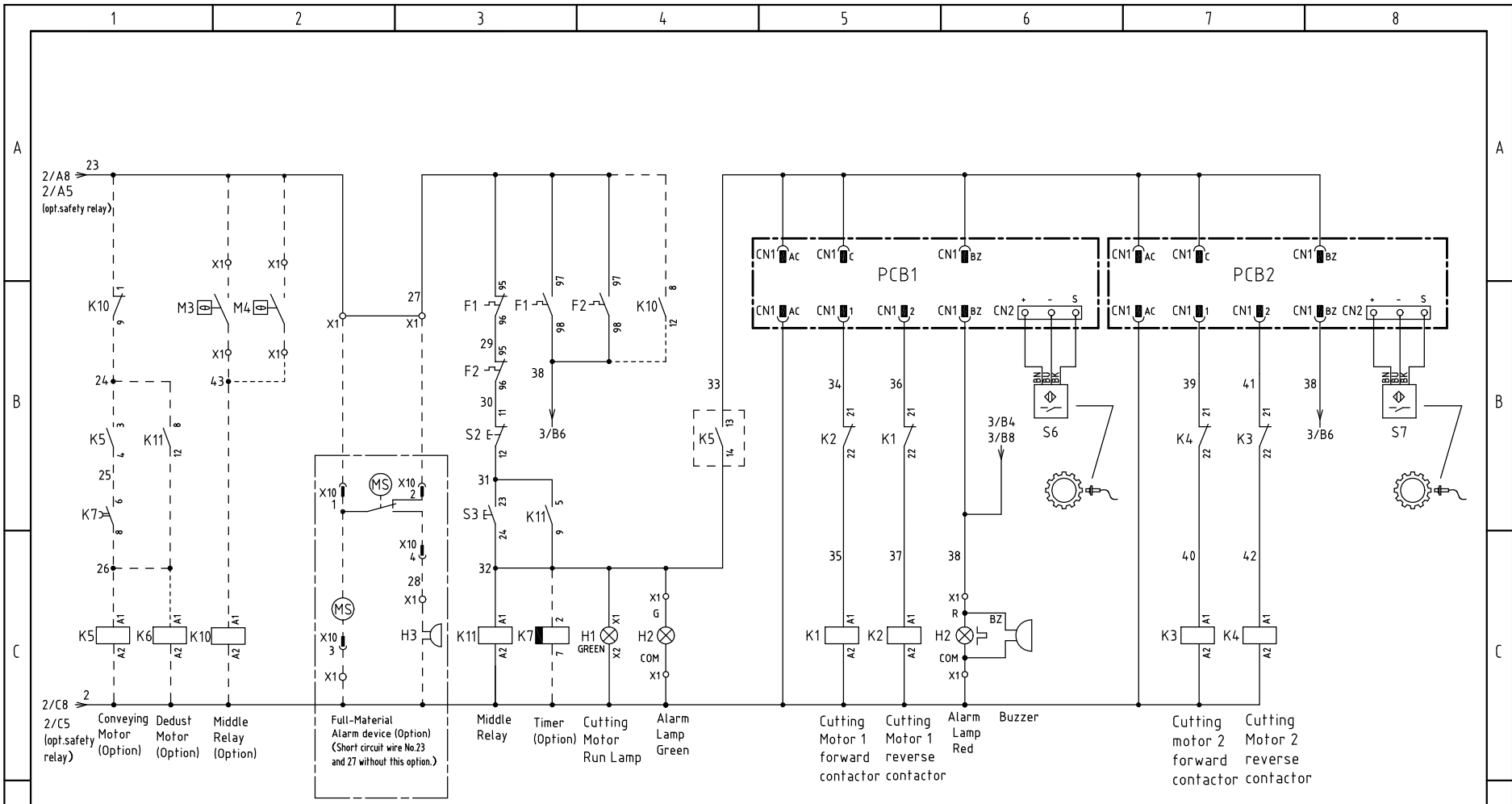

机型版本 Ver.C

Mark	Before modification	After modification	Modified by	Modify date	Checked by	Date
				Drawer	Version	
				Designer	Approved by	
				Proofread by		

Title SG-2446T 控制电路图二		Drawing NO. SG-2446T-CE-230V-B-3		Scale CE	Page 3 Totally 6 Pages
Voltage 3φ230V		Frequency 50Hz			



1 2 3 4 5 6 7 8

A

B

C

D

A

B

C

D

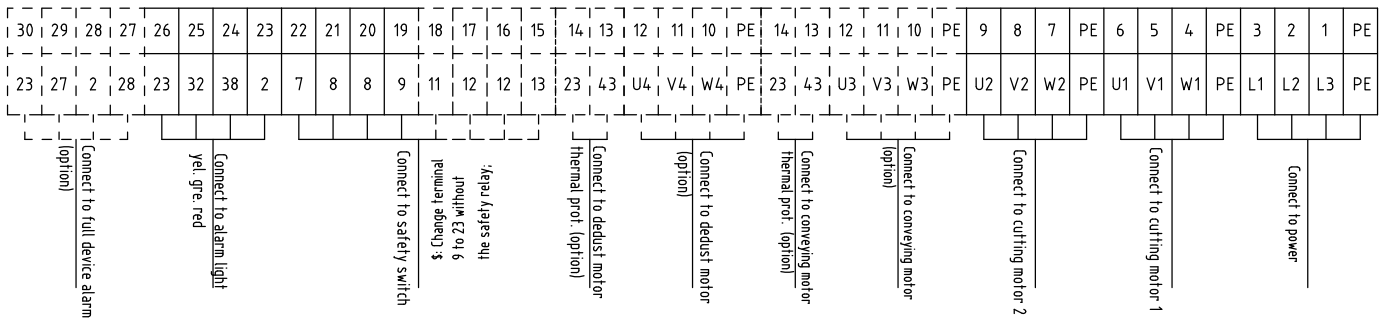
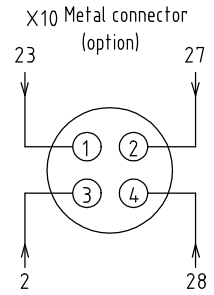
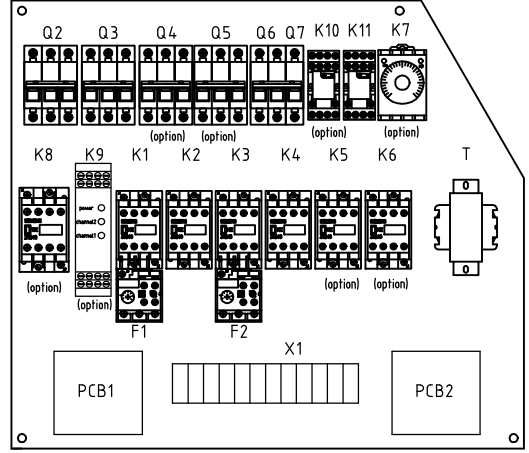
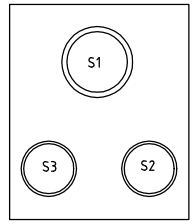

机型版本 Ver.C

Mark	Before modification	After modification	Modified by	Modify date	Checked by	Date	Version	Approved by	Proofread by	Designer	Drawer

Title SG-2446T  
电气元件布置图

Drawing NO. SG-2446T-CE-230V-B-4

**SHINI** 信易電熱機械股份有限公司  
Shini Plastics Technologies, Inc.

Scale	Page 4
Standard CE	Totally 6 Pages
Voltage	3φ230V
Frequency	50Hz

1 2 3 4 5 6 7 8

1		2		3		4		5		6		7		8	
N0.	Symbol	Name		Manufacturer		Type		Specification		Number	Material number		Remark		
1	Q1	Main power switch		MOELLER		P1-25/EA/SVB		25A		1	YE10125250000		(1)		
2	Q2 Q3	Circuit breakers		TECO		BM-63C/3020S		20A		2	YE40302003000				
3	Q4	Circuit breakers		TECO		BM-63C/3P		6A		1	YE40300603000		(2)		
4	Q5	Circuit breakers		TECO		BM-63C/3P		6A		1	YE40300603000		(3) New		
5	Q6	Circuit breakers		TECO		BM-63C/2003S 2P		3A		1	YE40200203000				
6	Q7	Circuit breakers		TECO		BM-63C/1003S 1P		3A		1	YE40100203000				
7	K1 K2 K3 K4	Contactors		SIEMENS		3RT6018-1AB02		24 VAC 50/60Hz		4	YE00601802600				
8		Auxiliary contact		SIEMENS		3RH6911-1HA11		1NC+1NO		4	YE00691100100		(5)		
9	K5	<del>接触器/Contactors</del>		<del>SIEMENS</del>		<del>3RT6016-1AB01</del>		<del>24 VAC 50/60Hz</del>		<del>1</del>	<del>YE00601602500</del>		<del>(2)Cancel</del>		
10	K5	Contactors		SIEMENS		3RT6015-1AB01		24 VAC 50/60Hz		1	YE00601502500		New		
11		Auxiliary contact		SIEMENS		3RH6911-1HA11		1NC+1NO		1	YE00691100100		(2)		
12	K6	Contactors		SIEMENS		3RT6015-1AB01		24 VAC 50/60Hz		1	YE00601502500		(3) New		
13	K7	Timer relay		YUYUN		TRF-N		24 VAC		1	YE86032400000		(2)(3) New		
14	K8	Contactor		SIEMENS		3RT6027-1AC20		24 VAC 50/60Hz		1	YE00602702600		(5)		
15	K9	Safety relay		PILZ		PNOZ X2.8P		24 VAC/DC		1	YE04023000000		(5)		
16	K10	Middle relay		HoneyWell		GR-2C-AC24V		24 VAC		1	YE03022400300		(2)(3)New		
17	K11	Middle relay		HoneyWell		GR-4C-AC24V		24 VAC		1	YE03042400300				
18	F1 F2	Thermal overload relay		SIEMENS		3RU6116-1JB0		7-10A		2	YE01167100000				
19	T	Transformer		BAIYUN		IN=230V/200V OUT=24V		80VA		1	YE70023005200				
20	PCB1 PCB2	Microcomputer/PCB		YUYUN		AC-01		24 VAC		2	YE80012400600				
21	X1	Terminal board		HoneyWell		SK2.5		2.5mm <sup>2</sup>		17	YE60002503200				
22				HoneyWell		GK2.5 PE		2.5mm <sup>2</sup> PE		3	YE60002503400				
23				HoneyWell		SK2.5		2.5mm <sup>2</sup>		5	YE60002503200		(2)		
24				HoneyWell		GK2.5 PE		2.5mm <sup>2</sup> PE		1	YE60002503400		(2)		
25				HoneyWell		SK2.5		2.5mm <sup>2</sup>		5	YE60002503200		(3) New		
机型版本		Ver.C		Notes:(1)Materials not in the control box;(2)Conveying blower assembly;(3)Dedust blower assembly;(4) Full- material alarm options;(5) Safety relay accessories;											
D					Drawer		Version		Title	SG-2446T		Drawing NO.	Scale		Page 5
					Designer		Approved by		电气元件明细表一		SG-2446T-CE-230V-B-5		Standard	CE	Totally 6 Pages
					Proofread by				 信易電熱機械股份有限公司 Shini Plastics Technologies, Inc.		Voltage		3φ230V		
	Mark	Before modification	After modification	Modified by	Modify date	Checked by	Date	Frequency			50Hz				
1		2		3		4		5		6		7		8	

	1	2	3	4	5	6	7	8		
	NO.	Symbol	Name	Manufacturer	Type	Specification	Number	Material number	Remark	
A	26			HoneyWell	GK2.5 PE	2.5mm <sup>2</sup> PE	1	YE60002503400	(3) 新增	
	27			HoneyWell	SK2.5	2.5mm <sup>2</sup>	4	YE60002503200	(4)	
	28			HoneyWell	SK2.5	2.5mm <sup>2</sup>	4	YE60002503200	(5)	
	29	X10	Metal connector	SHINI	254-P/R公	250V 4P	1	YE68025400000	(1)(4)	
	30			SHINI	254-P/R母	250V 4P	1	YE68025400100	(1)(4)	
	31	S1	Emergency stop button	SCHNEIDER	XB2BS542C	230VAC	1	YE11254200000	(1)	
B	32		Contact block	SCHNEIDER	ZB2BE102C	1NC	1	YE00210203100	(1)(5)	
	33	S2	Stop button	SCHNEIDER	XB2BA22C	230VAC	1	YE11222000000	(1)	
	34	S3 H1	Start button	SCHNEIDER	XB2BW33B1C	24VAC	1	YE11233100000	(1)	
	35		Contact block	SCHNEIDER	ZB2BE101C	1NO	1	YE00210103100	(1)(5)	
	36	S4 S5	Safety switch	SCHMERSAL	AZ 152VK-1476	AC-15	2	YE16147600100	(1)	
	37	S4 S5	Safety switch	SCHMERSAL	AZ16-02ZVRK-M16-1476-1	250V 3A	2	YE16147600000	(1)(5)	
	38	S6 S7	Sensor	DELING	DL-12	24VDC NPN	2	YE15122400000	(1)	
	39	H2	3-color alarm light	SHINI	Red. gre. yel.+buzzer	24VAC	1	BL90002401520	(1)	
	40	H3	Buzzer	TEND	EA-2	24VAC	1	YE84240200000	(1)(4)	
	C	41	MS	Level sensor	SIPAI	SR-80	24VAC 50/60Hz	1	YE15802400100	(1)(4)
42		M1 M2	Cutting motor	SEW	2.2kW	230V 50Hz	2	-----	(1)	
43		M3	Conveying motor	SHINI	0.55kW	230V 50Hz	1	-----	(1)(2)	
44		M4	Dedust blower	SHINI	0.12kW	230V 50Hz	1	-----	(1)(3) New	
D	机型版本 Ver.C		Notes:(1)Materials not in the control box;(2)Conveying blower assembly;(3)Dedust blower assembly;(4) Full- material alarm options; (5) Safety relay accessories;							
				Drawer	Version	Title	Drawing NO.	Scale	Page 6	
				Designer	Approved by	电气元件明细表二	SG-2446T-CE-230V-B-6	Standard	CE	Totally 6 Pages
				Proofread by			信易電熱機械股份有限公司 Shini Plastics Technologies, Inc.	Voltage	3φ230V	
	Mark	Before modification	After modification	Modified by	Modify date			Checked by	Date	Frequency
	1	2	3	4	5	6	7	8		