

1	2	3	4	5	6	7	8																
A	B						C	D															
A	B						C	D															
<div style="display: flex; justify-content: space-between;"> <div style="width: 20%;"> <p>③ 总电流</p> <p>④ 主电源线径</p> <p>⑤ 主断路器额定电流</p> <p>⑥ 送料风机断路器额定电流</p> </div> <div style="width: 20%;"> <p>⑦ 除尘风机断路器额定电流</p> <p>⑧ 粉碎电机负载器</p> <p>⑨ 粉碎电机负载器</p> <p>⑩ 送料风机负载器</p> <p>⑪ 送料风机负载器</p> </div> <div style="width: 20%;"> <p>⑫ 送料风机线径</p> <p>⑬ 送料风机功率</p> <p>⑭ 送料风机功率</p> <p>⑮ 除尘风机功率</p> </div> <div style="width: 20%;"> <p>⑯ 除尘风机负载器设定</p> <p>⑰ 除尘风机线径</p> <p>⑱ 除尘风机功率</p> <p>⑲ 除尘风机电流</p> </div> </div>																							
型号	版本号	①	②	③	④	⑤	⑥	⑦	⑧	⑨	⑩	⑪	⑫	⑬	⑭	⑮	⑯	⑰	⑱	⑲	⑳		
SG-3060	VER.C	31.5	10	60	6	6	14-20	17	4.0	15	29	1.4-2	1.4	2.5	0.55	1.4	0.9-1.25	0.9	2.5	0.25	0.9		
SG-3048	VER.C	24.5	6.0	50	6	6	11-16	13	2.5	11	22	1.4-2	1.4	2.5	0.55	1.4	0.9-1.25	0.9	2.5	0.25	0.9		
SG-2348	VER.C	24.5	6.0	50	6	6	11-16	13	2.5	11	22	1.4-2	1.4	2.5	0.55	1.4	0.9-1.25	0.9	2.5	0.25	0.9		
SG-2336	VER.C	18.5	6.0	4.0	6	6	14-20	16	4.0	7.5	16	1.4-2	1.4	2.5	0.55	1.4	0.9-1.25	0.9	2.5	0.25	0.9		
SG-2324	VER.C	14.5	4.0	4.0	6	6	11-16	12	2.5	5.5	12	1.4-2	1.4	2.5	0.55	1.4	0.9-1.25	0.9	2.5	0.25	0.9		
版本	Ver.C																						
制图																							
设计																							
校对																							
审核																							
更改后	更改后	日期	日期	日期	日期	日期	日期	日期	日期	日期	日期	日期	日期	日期	日期	日期	日期	日期	日期	日期	日期	日期	
更改前	更改后	更改人	更改人	更改人	更改人	更改人	更改人	更改人	更改人	更改人	更改人	更改人	更改人	更改人	更改人	更改人	更改人	更改人	更改人	更改人	更改人	更改人	
标记	更改前	更改后	日期	日期	日期	日期	日期	日期	日期	日期	日期	日期	日期	日期	日期	日期	日期	日期	日期	日期	日期	日期	
标题		SG-23/30		图号		SG-23/30-CE-4.00V-E-1		比例		CE		第 1 张		共 19 张		机器电压		4.00V		机器频率		50Hz	
SHINI		信易塑料机械股份有限公司		Shini Plastics Technologies, Inc.		功率、线径、电流表		SG-23/30		E		核 准		20170424		5		6		7		8	

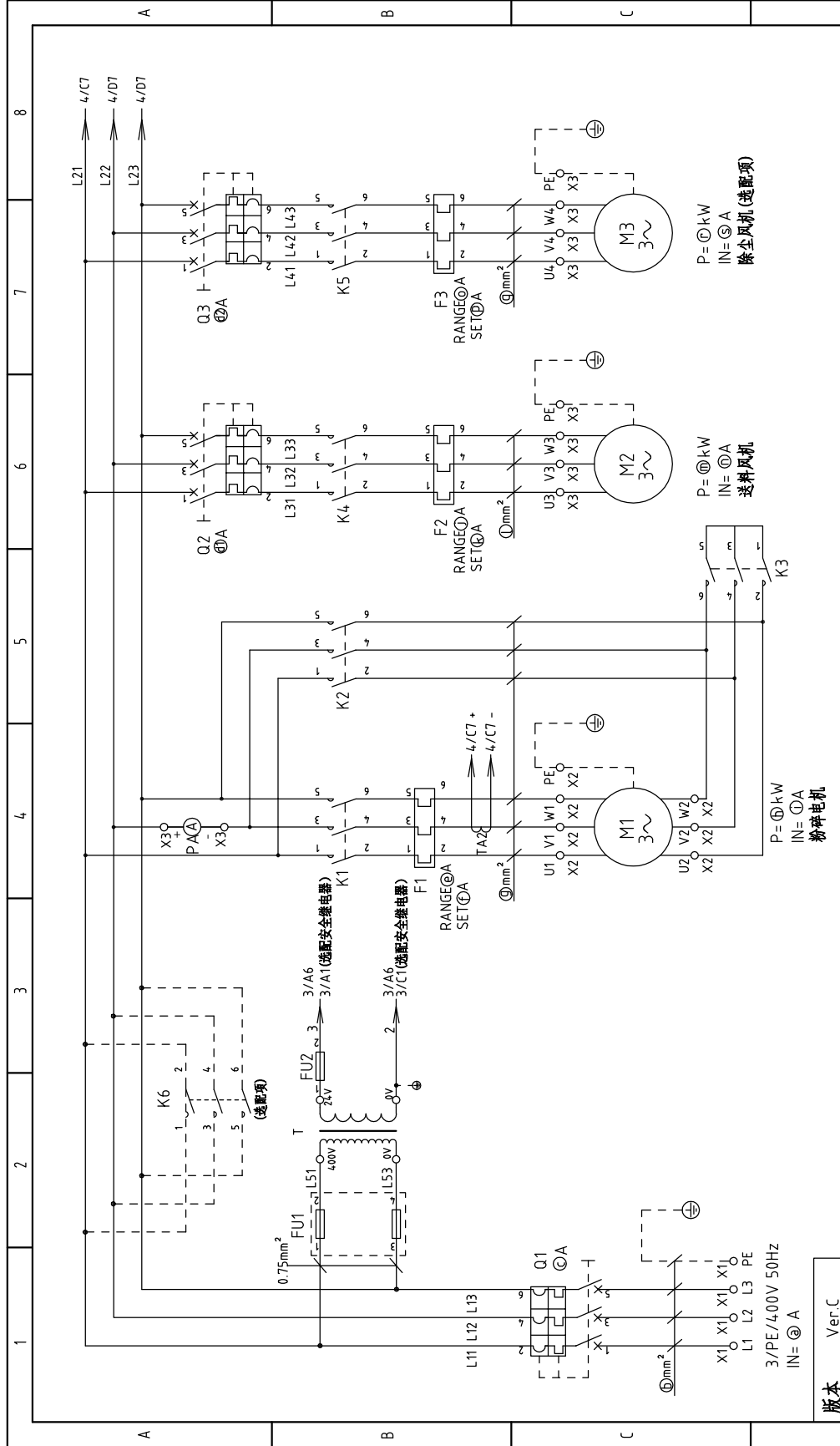



版本 Ver.C

制图	版号	标题	图号	比例	第 2 张
设计	核 准	SG-2348/30	SG-23/30-CE-400V-E-2	标准	共 19 张
校对	日期	主电路图		机器电压	400V
审核	日期			机器频率	50Hz
更改前	更改后				
更改人	更改日期				
20170424					

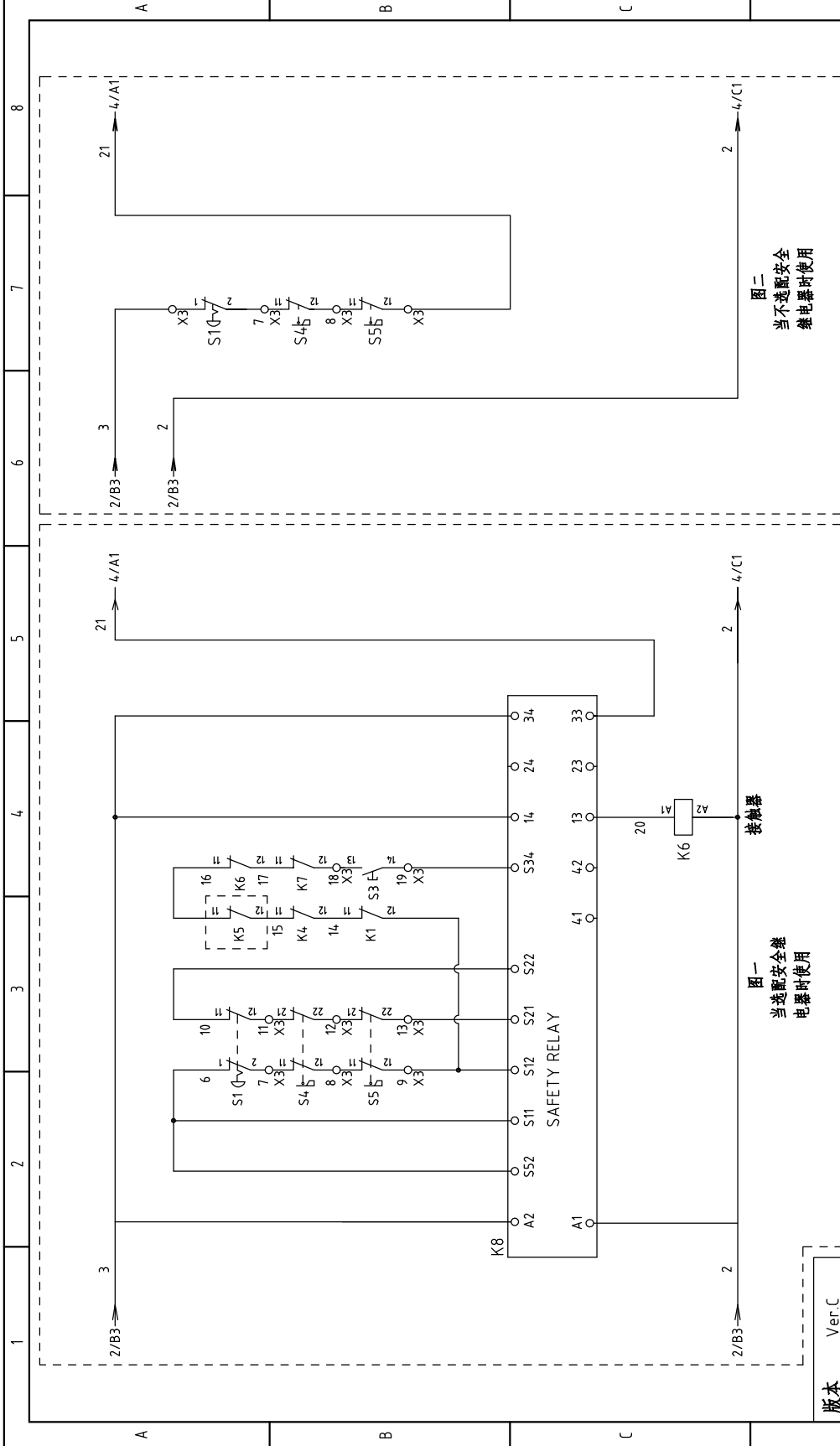

信易塑料机械股份有限公司  
Shini Plastics Technologies, Inc.



版本 Ver.C	图号 SG-2348/30		第 3 张
	控制电路图一		共 19 张
制图	版号	标题	比例
设计	核 准	SG-23/30-CE-400V-E-3	标准
校对	日期	 <b>信易塑料机械股份有限公司</b> Shini Plastics Technologies, Inc.	机器电压
更改前	更改人		机器频率
更改后	日期	20170424	400V
1	2	3	4
5	6	7	8

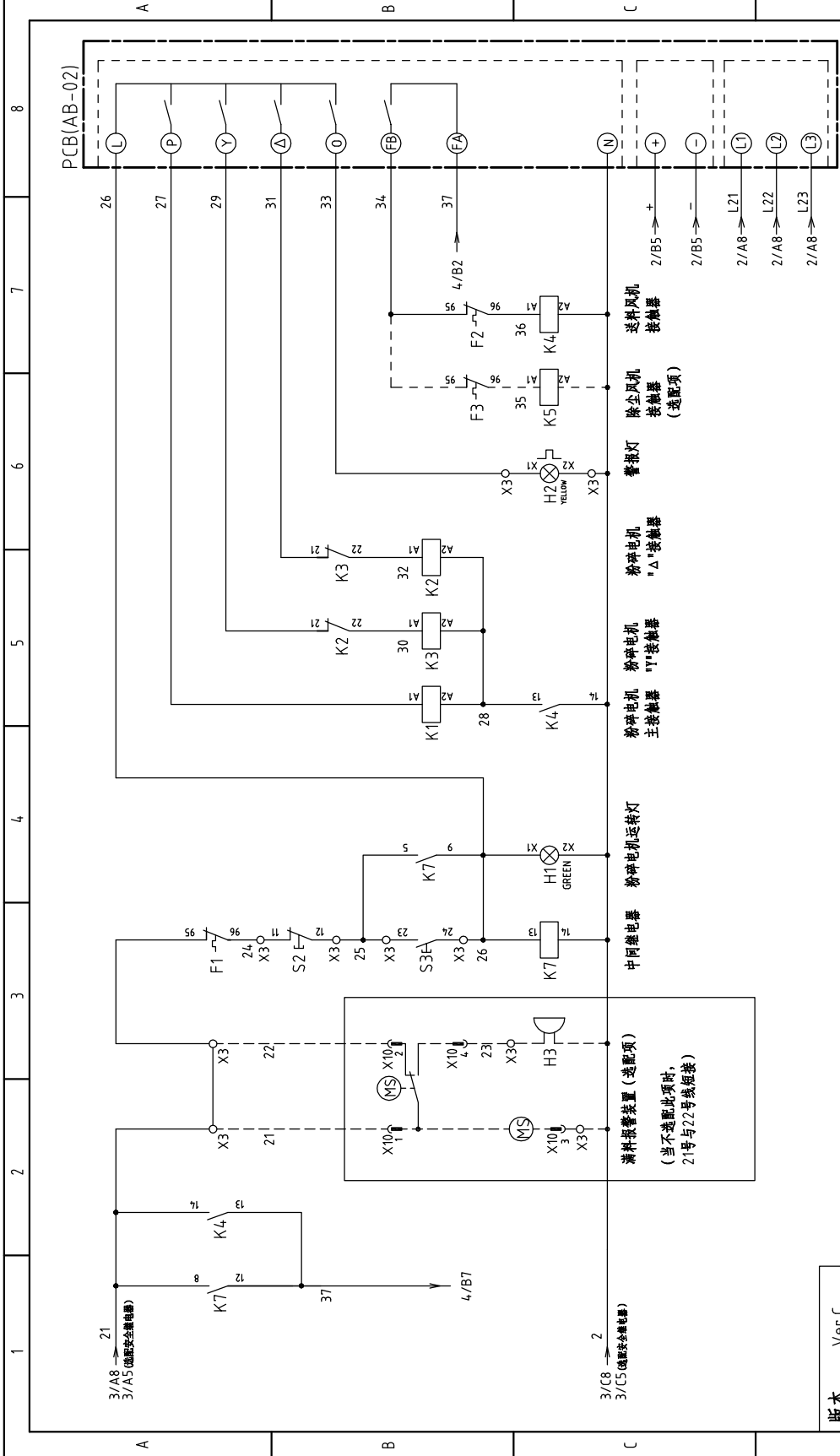

版本	Ver.C		
	制图	版号	图号
设计	E	SG-2348/30	比例
校对	核	控制电路图二	标准
审核	准		CE
日期	日期	20170424	共 19 张
更改人	更改日期		第 4 张
更改后			4.00V
更改前			50Hz
标记			8

标题 SG-2348/30  
控制电路图二

图号 SG-23/30-CE-4.00V-E-4

信易塑料机械股份有限公司  
Shini Plastics Technologies, Inc.



1 2 3 4 5 6 7 8

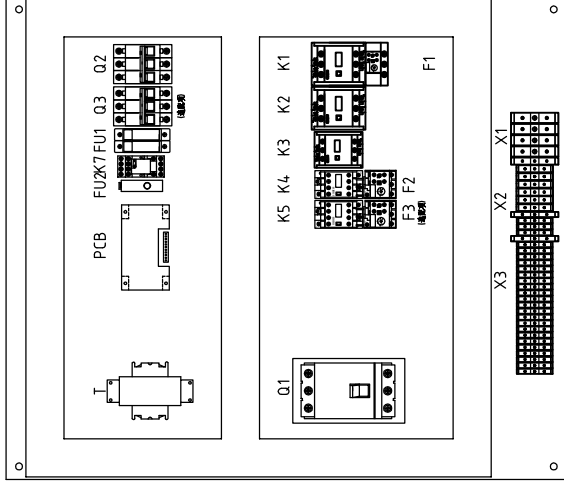
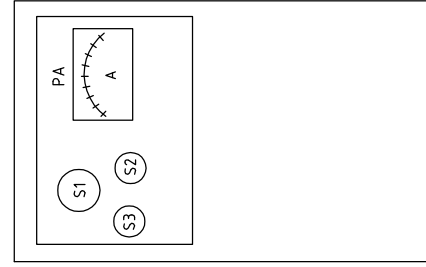

X10 金属接头接线示意图  
(选配项)

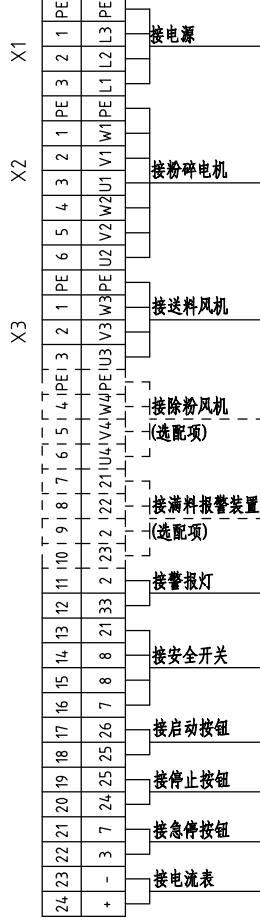
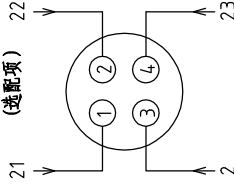

版本 Ver.C

制图	版号	标题	图号	比例	第 5 张
设计	E	SG-2348/30	SG-23/30-CE-400V-E-5	标准	共 19 张
校对	核 准	电气元件布置图(不透磁安全继电器)		CE	400V
审核	日期			机器电压	50Hz
更改前	更改后			机器频率	
更改人	更改日期				
日期	20170424				



信易塑料机械股份有限公司  
Shini Plastics Technologies, Inc.

1 2 3 4 5 6 7 8

1 2 3 4 5 6 7 8

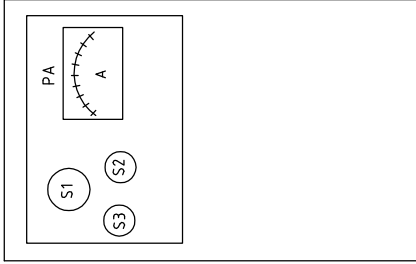
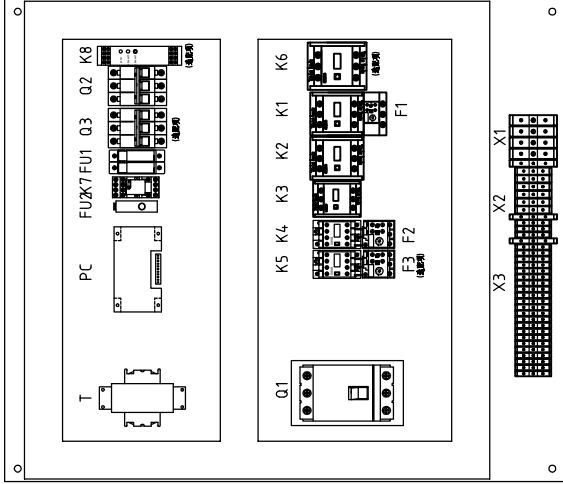

X10 金属接头接线示意图

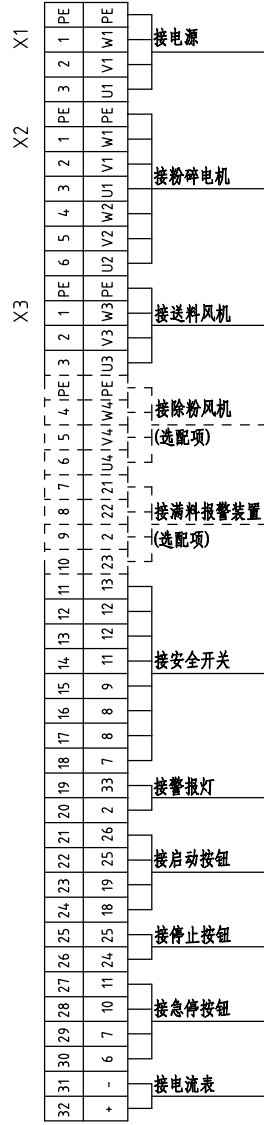
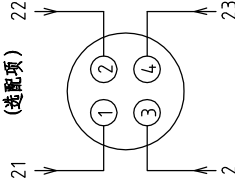

版本 Ver.C

标题	SG-2348/30	图号	比例	第 6 张
电气元件布置图 (选配安全继电器)			标准	共 19 张
			机器电压	4.00V
			机器频率	50Hz



制图	设计	校对	审核
版号	核 准	日期	20170424
更改前	更改后	更改人	日期

1 2 3 4 5 6 7 8

1	2	3	4	5	6	7	8
序号/NO.	符号/Symbol	名称/Name	制造商/Manufacturer	型号/Type	规格/Specification	数量/Number	物料编号/Material number
1	Q1	门联锁断路器/Breaker interlock	ABB	A1A125TMF60	60A	1	YE41106200000
2	Q2	断路器/Circuit breaker	TECO	BM-63C	6A	1	YE40300603000
3	Q3	断路器/Circuit breaker	TECO	BM-63C	6A	1	YE40300603000
4	K1	接触器/Contactor	SIEMENS	3RT6026-1AC20	24V 50/60Hz	1	YE00602602600
5	K2	接触器/Contactor	SIEMENS	3RT6026-1AC20	24V 50/60Hz	1	YE00602602600
6	K3	接触器/Contactor	SIEMENS	3RT6025-1AC20	24V 50/60Hz	1	YE00602502600
7	K4	接触器/Contactor	SIEMENS	3RT6016-1AB01	24V 50/60Hz	1	YE00601602500
8		辅助触点/Auxiliary contactor	SIEMENS	3RH6911-1HA11	1NC+1NO	1	YE00691100100
9	K5	接触器/Contactor	SIEMENS	3RT6016-1AB02	24V 50/60Hz	1	YE00601602600
10	K6	接触器/Contactor	SIEMENS	3RT6028-1AC20	24V 50/60Hz	1	YE00602802600
11	K7	中间继电器/Middle relay	Honeywell	GR-2C-AC24V	24VAC	1	YE03022400300
12	K7	中间继电器/Middle relay	Honeywell	GR-4C-AC24V	24VAC	1	YE03042400300
13	K8	安全继电器/Safety relay	PILZ	PN0Zx2.8P	24V AC/DC	1	YE04023000000
14	F1	热过载继电器/Overload relay	SIEMENS	3RU6126-4BB0	1A-20A	1	YE01260140000
15	F2	热过载继电器/Overload relay	SIEMENS	3RU6116-1BB0	1.4-2A	1	YE01160140000
16	F3	热过载继电器/Overload relay	SIEMENS	3RU6116-0KB0	0.9-1.25A	1	YE01160900000
17	FU1	熔断器/Fuse	CHNT	MRO/32A/2P	32A	1	YE41032200000
18		熔断器芯/Fuse core	CHNT	10x38 500V	2A	2	YE46002000100
19	FU2	熔断器/Fuse	YINDA	FS-10	2A	1	YE41001000000
20		玻璃保险管/Glass Tube	---	6x30	5A	1	YE46630500100
21	T	变压器/Transformer	BAIYUN	IN=400V OUT=24V	120VA	1	YE70402400700
22	X1	端子排/Terminal	HONEYWELL	10mm <sup>2</sup>	---	3	YE60001003200
23		端子排/Terminal	HONEYWELL	10mm <sup>2</sup> PE	---	1	YE60001003500
24	X2	端子排/Terminal	HONEYWELL	4mm <sup>2</sup>	---	6	YE60000403200
25		端子排/Terminal	HONEYWELL	4mm <sup>2</sup> PE	---	1	YE60000403500
<p><b>版本</b> Ver.C</p> <p><b>注:</b> (1)表示非电控箱内材料;(2)表示除尘电机选配件;(3)表示满料报警装置选配件;(4)表示安全继电器选配件。</p>							
			<p>标题 SG-3060</p> <p>电气元件明细表一</p>		<p>图号 SG-23/30-CE-400V-E-7</p>		<p>比例 标准</p>
			 <p>信易塑料机械股份有限公司 Shini Plastics Technologies, Inc.</p>		<p>CE</p> <p>机器电压 400V</p> <p>机器频率 50Hz</p>		<p>第 7 张 共 19 张</p>
<p>标记 更改前 更改后 更改人 日期 审核</p>			<p>日期 20170424</p>		<p>5</p>		<p>6</p>
<p>1</p>			<p>3</p>		<p>4</p>		<p>5</p>
<p>2</p>			<p>4</p>		<p>5</p>		<p>6</p>
<p>3</p>			<p>4</p>		<p>5</p>		<p>6</p>
<p>4</p>			<p>4</p>		<p>5</p>		<p>6</p>
<p>5</p>			<p>4</p>		<p>5</p>		<p>6</p>
<p>6</p>			<p>4</p>		<p>5</p>		<p>6</p>
<p>7</p>			<p>4</p>		<p>5</p>		<p>6</p>
<p>8</p>			<p>4</p>		<p>5</p>		<p>6</p>
<p>9</p>			<p>4</p>		<p>5</p>		<p>6</p>
<p>10</p>			<p>4</p>		<p>5</p>		<p>6</p>
<p>11</p>			<p>4</p>		<p>5</p>		<p>6</p>
<p>12</p>			<p>4</p>		<p>5</p>		<p>6</p>
<p>13</p>			<p>4</p>		<p>5</p>		<p>6</p>
<p>14</p>			<p>4</p>		<p>5</p>		<p>6</p>
<p>15</p>			<p>4</p>		<p>5</p>		<p>6</p>
<p>16</p>			<p>4</p>		<p>5</p>		<p>6</p>
<p>17</p>			<p>4</p>		<p>5</p>		<p>6</p>
<p>18</p>			<p>4</p>		<p>5</p>		<p>6</p>
<p>19</p>			<p>4</p>		<p>5</p>		<p>6</p>
<p>20</p>			<p>4</p>		<p>5</p>		<p>6</p>
<p>21</p>			<p>4</p>		<p>5</p>		<p>6</p>
<p>22</p>			<p>4</p>		<p>5</p>		<p>6</p>
<p>23</p>			<p>4</p>		<p>5</p>		<p>6</p>
<p>24</p>			<p>4</p>		<p>5</p>		<p>6</p>
<p>25</p>			<p>4</p>		<p>5</p>		<p>6</p>

1	2		3			4	5		6	7		8
序号/NO.	符号/Symbol	名称/Name	制造商/Manufacturer	型号/Type	规格/Specification	数量/Number	物料编号/Material number	备注/Remark				
26	X3	端子排/Terminal	HONEYWELL	6mm <sup>2</sup>	---	2	YE60000603200					
27			HONEYWELL	2.5mm <sup>2</sup>	---	15	YE60002503200					
28			HONEYWELL	2.5mm <sup>2</sup> PE	---	1	YE60002503400		A			
29			HONEYWELL	2.5mm <sup>2</sup>	---	3	YE60002503200	(2)				
30			HONEYWELL	2.5mm <sup>2</sup> PE	---	1	YE60002503400	(2)				
31			HONEYWELL	2.5mm <sup>2</sup>	---	4	YE60002503200	(3)				
32			HONEYWELL	2.5mm <sup>2</sup>	---	8	YE60002503200	(4)				
33	X10	金属接头/Metal joint	SHINI	PLT-254PM	4P	1	YE68025400000	(1)(3)				
34			SHINI	PLT-254RF	4P	1	YE68025400100	(1)(3)				
35	PCB	微电脑板/PCB	YUYUN	AB-02	24VAC	1	YE80022400100					
36	S1	急停按钮/Emergency stop button	SCHNEIDER	XB2BS542C	400VAC	1	YE11254200000	(1)	B			
37		触点块/Contact block	SCHNEIDER	ZB2BE102C	1NC	1	YE00210203100	(1)(4)				
38	S2	停止按钮/Stop button	SCHNEIDER	XB2BA22C	400VAC	1	YE11222000000	(1)				
39	S3.H1	启动按钮(带灯)/Start button	SCHNEIDER	XB2BW33B1C	24VAC	1	YE11233100000	(1)				
40		触点块/Contact block	SCHNEIDER	ZB2BE101C	1NO	1	YE00210103100	(1)(4)				
41	S4, S5	安全开关/Safety switch	SCHMERSRC	AZ15-02ZVRK-1476	AZ-15	2	YE16147600100	(1)				
42	S4, S5	安全开关/Safety switch	SCHMERSRC	AZ16-02ZVRK-1476	AZ-16	2	YE16147600000	(1)(4)				
43	H2	警光灯/Alarm light	SHINI	LED-3051	24VAC	1	YE83305100900	(1)				
44	H3	蜂鸣器/Buzzer	TEND	EA-2	24VAC	1	YE84240200000	(1)(3)	C			
45	MS	料位开关/Material level sensor	SIPAI	SR-80	24VAC	1	YE5802400100	(1)(3)				
46	TA2	电流互感器/Current transformer	YUYUN	-----	5-100A	1	-----	线路板自带				
47	PA	电流表/Ammeter	SFIM	DH-670	50A	1	YE25675000000	(1)				
48	M1	粉碎电机/Granulating motor	-----	15KW	400V 50Hz	1	-----	(1)				
49	M2	吸料风机/Suction blower	-----	0.55KW	400V 50Hz	1	-----	(1)				
50	M3	除尘风机/Dust-removing blower	-----	0.25KW	400V 50Hz	1	-----	(1)(2)				
版本 Ver.C												
注: (1)表示非电控箱内材料;(2)表示除尘电机选配配件;(3)表示满料报警装置选配配件;(4)表示安全继电器选配配件。												
D												
			制图		版号		标题		图号		比例	
			设计		核 准		SG-3060		SG-23/30-CE-400V-E-8		第 8 张	
			校对		日期		电 气 元 件 明 细 表 二		标准		共 19 张	
			审核		日期		SHINI		机器电压		400V	
标记			更改前		更改后		更改人		日期		50Hz	
1			3		4		5		6		8	
			20170424				信易塑料机械股份有限公司 Shini Plastics Technologies, Inc.		机器频率		50Hz	



1	2	3	4	5	6	7	8
序号/NO.	符号/Symbol	名称/Name	制造商/Manufacturer	型号/Type	规格/Specification	数量/Number	物料编号/Material number
1	Q1	门联锁断路器/Breaker interlock	ABB	A1A125TMF50	50A	1	YE4.1105200000
2	Q2	断路器/Circuit breaker	TECO	BM-63C	6A	1	YE4.0300603000
3	Q3	断路器/Circuit breaker	TECO	BM-63C	6A	1	YE4.0300603000
4	K1	接触器/Contactor	SIEMENS	3RT6025-1AC20	24VAC 50/60Hz	1	YE00602502600
5	K2	接触器/Contactor	SIEMENS	3RT6025-1AC20	24VAC 50/60Hz	1	YE00602502600
6	K3	接触器/Contactor	SIEMENS	3RT6018-1AB02	24VAC 50/60Hz	1	YE00601802600
7	K4	接触器/Contactor	SIEMENS	3RT6016-1AB01	24VAC 50/60Hz	1	YE00601602500
8		辅助触点/Auxiliary contactor	SIEMENS	3RH6911-1HA11	1NC+1NO	1	YE00691100100
9	K5	接触器/Contactor	SIEMENS	3RT6016-1AB02	24VAC 50/60Hz	1	YE00601602600
10	K6	接触器/Contactor	SIEMENS	3RT6027-1AC20	24VAC 50/60Hz	1	YE00602702600
11	K7	中间继电器/Middle relay	Honeywell	GR-2C-AC24V	24VAC	1	YE03022400300
12	K7	中间继电器/Middle relay	Honeywell	GR-4C-AC24V	24VAC	1	YE03042400300
13	K8	安全继电器/Safety relay	PILZ	PN0Zx2.8P	24V AC/DC	1	YE04023000000
14	F1	热过载继电器/Overload relay	SIEMENS	3RU6126-4AB0	11-16A	1	YE01260110000
15	F2	热过载继电器/Overload relay	SIEMENS	3RU6116-1BB0	1.4-2A	1	YE01160140000
16	F3	热过载继电器/Overload relay	SIEMENS	3RU6116-0KB0	0.9-1.25A	1	YE01160900000
17	FU1	熔断器/Fuse	CHNT	MRO/32A/2P	32A	1	YE4.1032200000
18		熔断器芯/Fuse core	CHNT	10x38 500V	2A	2	YE4.6002000100
19	FU2	熔断器/Fuse	YINDA	FS-10	---	1	YE4.10010000000
20		玻璃保险管/Glass Tube	---	6x30	5A	1	YE4.6630500100
21	T	变压器/Transformer	BAIYUN	IN=400V OUT=24V	120VA	1	YE704.024.00700
22	X1	端子排/Terminal	HONEYWELL	6mm <sup>2</sup>	---	3	YE60000603200
23		端子排/Terminal	HONEYWELL	6mm <sup>2</sup> PE	---	1	YE60000603500
24	X2	端子排/Terminal	HONEYWELL	2.5mm <sup>2</sup>	---	6	YE60002503200
25		端子排/Terminal	HONEYWELL	2.5mm <sup>2</sup> PE	---	1	YE60002503400
A							
B							
C							
D							
版本	Ver.C	制图		标题	图号	比例	第 9 张
		设计	版号	SG-3048/2348	SG-23/30-CE-400V-E-9	标准	共 19 张
		校对	核准	电气元件明细表一		机电电压	400V
标记	更改前	更改后	日期	日期	日期	机电频率	50Hz
1	2	3	4	5	6	7	8

注: (1)表示非电控箱内材料;(2)表示除尘电机及配件;(3)表示满料报警装置及配件;(4)表示安全继电器及配件。



1	2		3			4		5		6		7		8	
序号/NO.	符号/Symbol	名称/Name	制造商/Manufacturer	型号/Type	规格/Specification	数量/Number	物料编号/Material number	备注/Remark							
26	X3	端子排/Terminal	HONEYWELL	4mm <sup>2</sup>	---	2	YE60000403200								
27			HONEYWELL	2.5mm <sup>2</sup>	---	15	YE60002503200								
28			HONEYWELL	2.5mm <sup>2</sup> PE	---	1	YE60002503400								
29			HONEYWELL	2.5mm <sup>2</sup>	---	3	YE60002503200	(2)							
30			HONEYWELL	2.5mm <sup>2</sup> PE	---	1	YE60002503400	(2)							
31			HONEYWELL	2.5mm <sup>2</sup>	---	4	YE60002503200	(3)							
32			HONEYWELL	2.5mm <sup>2</sup>	---	8	YE60002503200	(4)							
33	X10	金属接头/Metal joint	SHINI	PLT-254-PM	4P	1	YE68025400000	(1)(3)							
34			----	PLT-254-RF	4P	1	YE68025400100	(1)(3)							
35	PCB	微电脑板/PCB	YUYUN	AB-02	24VAC	1	YE800022400100								
36	S1	急停按钮/Emergency stop button	SCHNEIDER	XB2BS542C	400VAC	1	YE11254200000	(1)							
37			SCHNEIDER	ZB2BE102C	1NC	1	YE00210203100	(1)(4)							
38	S2	停止按钮/Stop button	SCHNEIDER	XB2BA22C	400VAC	1	YE11222000000	(1)							
39	S3,H1	启动按钮(带灯)/Start button	SCHNEIDER	XB2BW33B1C	24VAC	1	YE11223100000	(1)							
40			SCHNEIDER	ZB2BE101C	1NO	1	YE00210103100	(1)(4)							
41	S4, S5	安全开关/Safety switch	SCHMERSRC	AZ15-02ZVRK-1476	AZ-15	2	YE16147600100	(1)							
42	S4, S5	安全开关/Safety switch	SCHMERSRC	AZ16-02ZVRK-1476	AZ-16	2	YE16147600000	(1)(4)							
43	H2	警报灯/Alarm light	SHINI	LED-3051	24VAC	1	YE83305100900	(1)							
44	H3	蜂鸣器/Buzzer	TEND	EA-2	24VAC	1	YE84240200000	(1)(3)							
45	MS	料位开关/Material level sensor	SIPAI	SR-80	24VAC	1	YE15802400100	(1)(3)							
46	TA2	电流互感器/Current transformer	YUYUN	-----	5-100A	1	-----	线路板自带							
47	PA	电流表/Ammeter	SFIM	DH-670	50A	1	YE25675000000	(1)							
48	M1	粉碎机/Granulating motor	-----	11KW	400V 50Hz	1	-----	(1)							
49	M2	吸料风机/Suction blower	-----	0.55KW	400V 50Hz	1	-----	(1)							
50	M3	除尘风机/Dust-removing blower	-----	0.25KW	400V 50Hz	1	-----	(1)(2)							
版本 Ver.C															
注: (1)表示非电控箱内材料;(2)表示除尘电控箱配件;(3)表示满料报警装置配件;(4)表示安全继电器配件。															
D															
图号 SG-3048/2348															
标题 SG-3048/2348 电气元件明细表二															
比例 标准 CE															
第 10 张 共 19 张															
机器电压 4.00V															
机器频率 5.0Hz															
															
信易塑料机械股份有限公司 Shini Plastics Technologies, Inc.															
1 2 3 4 5 6 7 8															

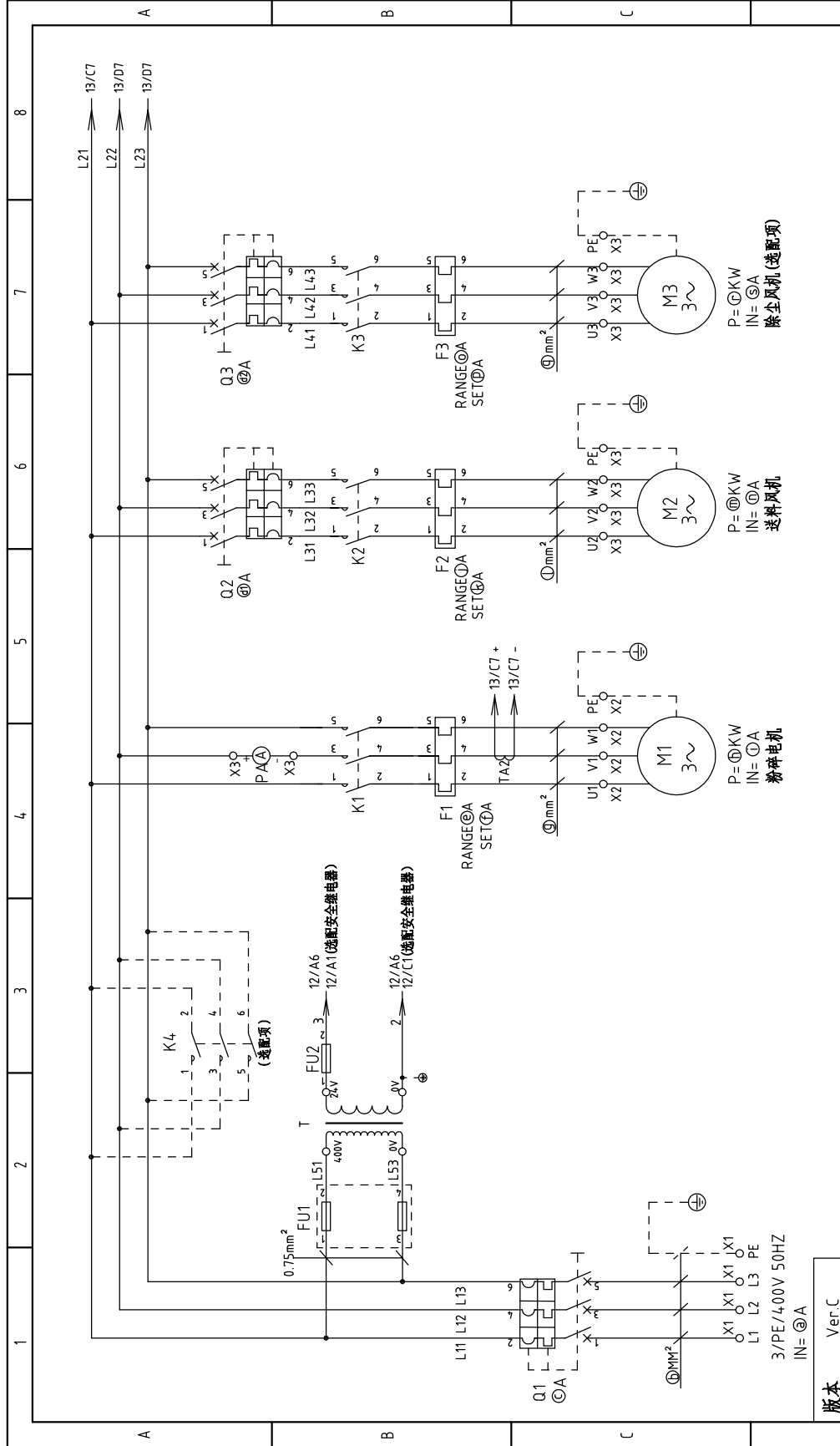

版本 Ver.C

制图		版号		标题		图号		比例		第 11 张	
设计	核 准	E		SG-23(23/48除外)		SG-23/30-CE-400V-E-11		标准	CE	共 19 张	
校对				主电路图				机器电压		400V	
审核				日期		日期		机器频率		50Hz	
更改前	更改后	更改人	日期	20170424				信易塑料机械股份有限公司		Shini Plastics Technologies, Inc.	
								SHINI		8	

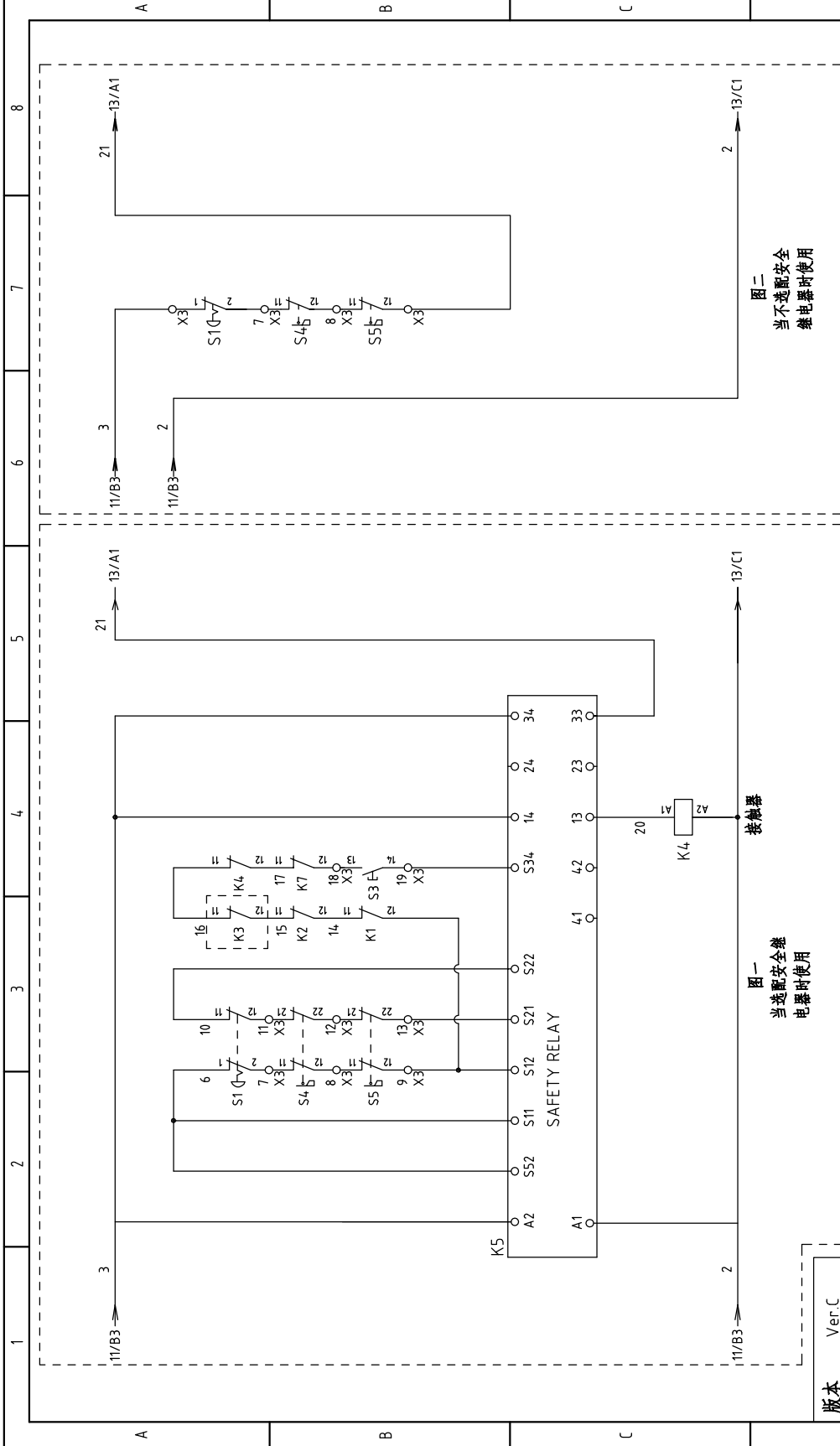

图一  
当不选配安全继电器时使用

图二  
当不选配安全继电器时使用

版本 Ver.C

制图	版号	图号	比例	第 12 张
设计	核 准	SG-23(2348除外) 控制电路图一	标准 CE	共 19 张
校对	日期	SG-23/30-CE-400V-E-12	机器电压	400V
审核	日期	<b>SHINI</b> 信易塑料机械股份有限公司 Shini Plastics Technologies, Inc.	机器频率	50Hz
更改前	更改后	20170424		
更改人	更改后	5		
日期	日期	6		
1	2	3	4	8



1 2 3 4 5 6 7 8

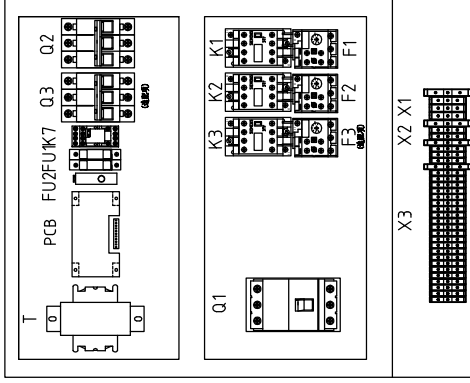
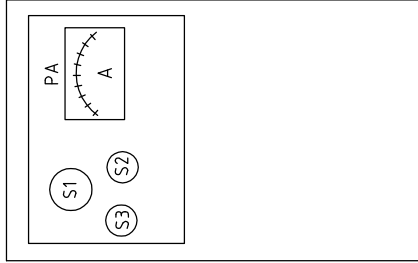

X10 金属接头接线示意图  
(选配项)

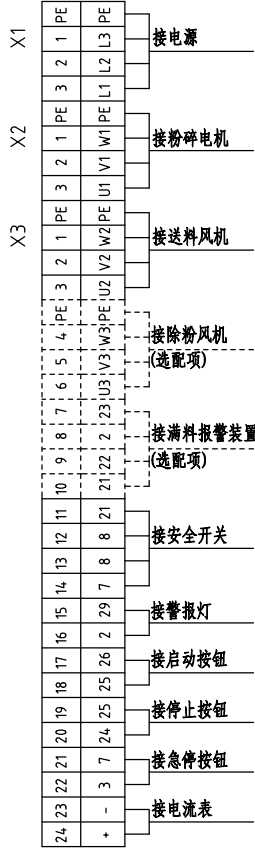
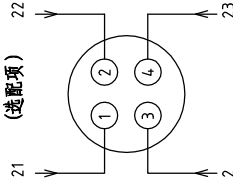

版本 Ver.C

制图	设计	校对	审核	日期	更改人	更改后	更改前	标记
版号	核 准	日期	20170424					
标题	SG-23(2348除外) 电气元件布置图(不选配安全继电器)		图号	SG-23/30-CE-400V-E-14		比例	标准	第 14 张
图号	SG-23/30-CE-400V-E-14		比例	标准	CE	共 19 张	机器电压	400V
信易塑料机械股份有限公司 Shini Plastics Technologies, Inc.			机器频率	50Hz				

1 2 3 4 5 6 7 8

1 2 3 4 5 6 7 8

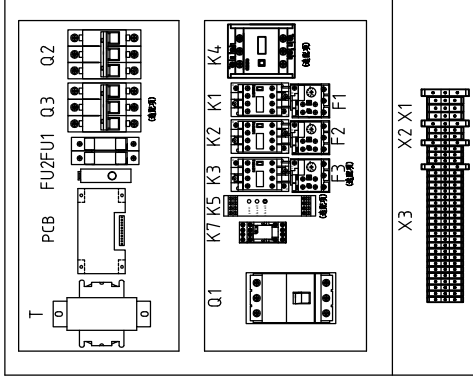
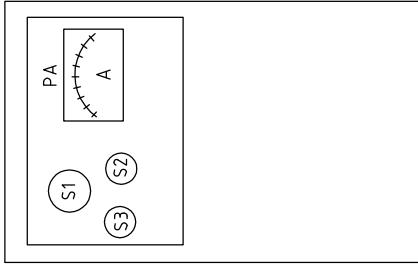

X10 金属接头接线示意图  
(选配项)

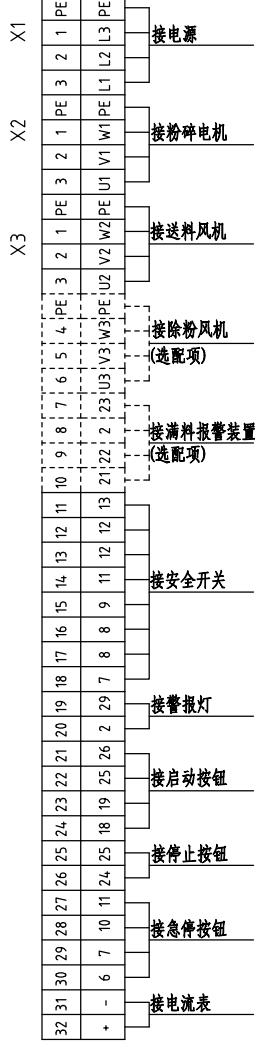
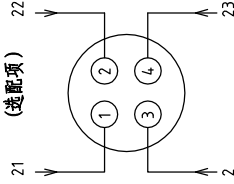

版本 Ver.C

制图	设计	校对	审核	日期	更改人	更改后	更改前	标记
版号	核 准	日期	20170424					
标题	SG-23(2348除外) 电气元件布置图(选配安全继电器)		图号		SG-23/30-CE-400V-E-15		比例	第 15 张
E		标准		CE		共 19 张		机器电压
		4.00V		机器频率		50Hz		



信易塑料机械股份有限公司  
Shini Plastics Technologies, Inc.

1 2 3 4 5 6 7 8

1	2	3	4	5	6	7	8
序号/NO.	符号/Symbol	名称/Name	制造商/Manufacturer	型号/Type	规格/Specification	数量/Number	物料编号/Material number
1	Q1	门联锁断路器/Breaker interlock	ABB	A1A125TMF40	40A	1	YE4-1104-200000
2	Q2	断路器/Circuit breaker	TECO	BM-63C	6A	1	YE4.0300603000
3	Q3	断路器/Circuit breaker	TECO	BM-63C	6A	1	YE4.0300603000
4	K1	接触器/Contactor	SIEMENS	3RT6026-1AC20	24VAC 50/60Hz	1	YE00602602600
5	K2	接触器/Contactor	SIEMENS	3RT6016-1AB01	24VAC 50/60Hz	1	YE00601602500
6		辅助触点/Auxiliary contactor	SIEMENS	3RH6911-1HA11	1NC+1NO	1	YE00691100100
7	K3	接触器/Contactor	SIEMENS	3RT6016-1AB02	24VAC 50/60Hz	1	YE00601522000
8	K4	接触器/Contactor	SIEMENS	3RT6026-1AC20	24VAC 50/60Hz	1	YE00602602600
9	K5	安全继电器/Safety relay	PILZ	PN0Z+2.8P	24V AC/DC	1	YE04.023000000
10	K7	中间继电器/Middle relay	Honeywell	GR-2C-AC24V	24VAC	1	YE030224.00300
11	K7	中间继电器/Middle relay	Honeywell	GR-4C-AC24V	24VAC	1	YE030424.00300
12	F1	热过载继电器/Overload relay	SIEMENS	3RU6126-4BB0	14-20A	1	YE0126014-0000
13	F2	热过载继电器/Overload relay	SIEMENS	3RU6116-1BB0	1.4-2A	1	YE0116014-0000
14	F3	热过载继电器/Overload relay	SIEMENS	3RU6116-0KB0	0.9-1.25A	1	YE01160900000
15	FU1	熔断器/Fuse	CHNT	MRO/32A/2P	32A	1	YE4-1032200000
16	FU2	熔断器芯/Fuse core	CHNT	10x38 500V	2A	2	YE4.6002000100
17	FU2	熔断器/Fuse	YINDA	FS-10	2A	1	YE4.1001000000
18		玻璃保险管/Glass tube	----	6x30	3A	1	YE4.6630500200
19	T	变压器/Transformer	BAIYUN	IN=400V OUT=24V	80VA	1	YE7004.0005900
20	X1	端子排/Terminal	HONEYWELL	6mm <sup>2</sup>	----	3	YE60000603200
21		端子排/Terminal	HONEYWELL	6mm <sup>2</sup> PE	----	1	YE60000603500
22	X2	端子排/Terminal	HONEYWELL	4mm <sup>2</sup>	----	3	YE600004.03200
23		端子排/Terminal	HONEYWELL	4mm <sup>2</sup> PE	----	1	YE600004.03500
24	X3	端子排/Terminal	HONEYWELL	4mm <sup>2</sup>	----	2	YE600004.03200
25		端子排/Terminal	HONEYWELL	2.5mm <sup>2</sup>	----	15	YE60002503200
<b>版本</b> Ver.C <b>注:</b> (1)表示非电控箱内材料;(2)表示除尘电机选配配件;(3)表示满料报警装置选配配件;(4)表示安全继电器选配配件。							
			<b>制图</b>	<b>版号</b> E	<b>标题</b> SG-2336	<b>图号</b>	<b>比例</b>
			<b>设计</b>	<b>核 准</b>	电气元件明细表一		标准 CE
			<b>校对</b>	<b>日期</b> 20170424	SG-23/30-CE-400V-E-16		机器电压 4.00V
<b>更改前</b>			<b>更改人</b>	<b>日期</b>	<b>SHINI</b> 信易塑料机械股份有限公司 Shini Plastics Technologies, Inc.		机器频率 50Hz
<b>更改后</b>			<b>更改日期</b>		5	6	7
1			4	5	6	7	8
			<b>第 16 张</b>			<b>共 19 张</b>	



1	2		3			4		5		6		7		8	
序号/NO.	符号/Symbol	名称/Name	制造商/Manufacturer	型号/Type	规格/Specification	数量/Number	物料编号/Material number	备注/Remark							
26			HONEYWELL	2.5mm <sup>2</sup> PE	----	1	YE60002503400								
27			HONEYWELL	2.5mm <sup>2</sup>	----	3	YE60002503200	(2)							
28			HONEYWELL	2.5mm <sup>2</sup> PE	----	1	YE60002503400	(2)							
29			HONEYWELL	2.5mm <sup>2</sup>	----	4	YE60002503200	(3)							
30			HONEYWELL	2.5mm <sup>2</sup>	----	8	YE60002503200	(4)							
31	X10	金属接头/Metal joint	SHINI	PLT-254-PM	4P	1	YE68025400000	(1)(3)							
32			-----	PLT-254-RF	4P	1	YE68025400100	(1)(3)							
33	PCB	微电脑板/PCB	YUYUN	AB-02	24VAC	1	YE80022400100								
34	S1	急停按钮/Emergency stop button	SCHNEIDER	XB2BS542C	400VAC	1	YE11254200000	(1)							
35		触点块/Contact block	SCHNEIDER	ZB2BE102C	1NC	1	YE00210203100	(1)(4)							
36	S2	停止按钮/Stop button	SCHNEIDER	XB2BA22C	400VAC	1	YE11222000000	(1)							
37	S3,H1	启动按钮(带灯)/Start button	SCHNEIDER	XB2BW33B1C	24VAC	1	YE11233100000	(1)							
38		触点块/Contact block	SCHNEIDER	ZB2BE101C	1NO	1	YE00210103100	(1)(4)							
39	S4, S5	安全开关/Safety switch	SCHMERSRC	AZ15-02ZVRK-1476	AZ-15	2	YE16147600100	(1)							
40	S4, S5	安全开关/Safety switch	SCHMERSRC	AZ16-02ZVRK-1476	AZ-16	2	YE16147600000	(1)(4)							
41	H2	警光灯/Alarm light	SHINI	LED-3051	24VAC	1	YE83305100900	(1)							
42	H3	蜂鸣器/Buzzer	TEND	EA-2	24VAC	1	YE84240200000	(1)(3)							
43	MS	料位开关/Material level sensor	SIPAI	SR-80	24VAC	1	YE15802400100	(1)(3)							
44	TA2	电流互感器/Current transformer	YUYUN	-----	5-100A	1	-----	线路板自带							
45	PA	电流表/Ammeter	SFIM	DH-670	50A	1	YE25675000000	(1)							
46	M1	粉碎电机/Granulating motor	-----	7.5KW	400V 50Hz	1	-----	(1)							
47	M2	吸料风机/Suction blower	-----	0.55KW	400V 50Hz	1	-----	(1)							
48	M3	除尘风机/Dust-removing blower	-----	0.25KW	400V 50Hz	1	-----	(1)(2)							
版本 Ver.C															
注: (1)表示非电控箱内材料;(2)表示除尘电机选配配件;(3)表示满料报警装置选配配件;(4)表示安全继电器选配配件.															
D															
图号 SG-2336															
比例 第 17 张															
标准 CE 共 19 张															
机器电压 4.00V															
机器频率 5.0Hz															
SHINI 信易塑料机械股份有限公司 Shini Plastics Technologies, Inc.															
SG-23/30-CE-400V-E-17															
20170424															
日期															
更改后 更改人 日期 审核															
更改前															
1 2 3 4 5 6 7 8															

1	2		3	4	5	6	7	8
序号/NO.	符号/Symbol	名称/Name	制造商/Manufacturer	型号/Type	规格/Specification	数量/Number	物料编号/Material number	备注/Remark
1	Q1	门联锁断路器/Breaker interlock	ABB	A1A125TMF40	40A	1	YE4-1104-200000	
2	Q2	断路器/Circuit breaker	TECO	BM-63C	6A	1	YE4-0300603000	
3	Q3	断路器/Circuit breaker	TECO	BM-63C	6A	1	YE4-0300603000	(2)
4	K1	接触器/Contactor	SIEMENS	3RT6018-1AB02	24VAC 50/60Hz	1	YE00601802600	
5	K2	接触器/Contactor	SIEMENS	3RT6016-1AB01	24VAC 50/60Hz	1	YE00601602500	
6		辅助触点/Auxiliary contactor	SIEMENS	3RH6911-1HA11	1NC-1NO	1	YE00691100100	
7	K3	接触器/Contactor	SIEMENS	3RT6016-1AB02	24VAC 50/60Hz	1	YE00601602600	(2)
8	K4	接触器/Contactor	SIEMENS	3RT6018-1AB02	24VAC 50/60Hz	1	YE00601802600	(4)
9	K5	安全继电器/Safety relay	PILZ	PN0Z+2.8P	24V AC/DC	1	YE04-023000000	(4)
10	K7	中间继电器/Middle relay	Honeywell	GR-2C-AC24V	24VAC	1	YE03022400300	
11	K7	中间继电器/Middle relay	Honeywell	GR-4C-AC24V	24VAC	1	YE03042400300	(4)
12	F1	热过载继电器/Overload relay	SIEMENS	3RU6116-4AB0	11-16A	1	YE01611640000	
13	F2	热过载继电器/Overload relay	SIEMENS	3RU6116-1BB0	1.4-2A	1	YE01160140000	
14	F3	热过载继电器/Overload relay	SIEMENS	3RU6116-0KB0	0.9-1.25A	1	YE01160900000	(2)
15	FU1	熔断器/Fuse	CHNT	MRO/32A/2P	32A	1	YE4-1032200000	
16	FU2	熔断器芯/Fuse core	CHNT	10x38 500V	2A	2	YE4-6002000100	
17	FU2	熔断器/Fuse	YINDA	FS-10	----	1	YE4-1001000000	
18		玻璃保险管/Glass tube	----	6x30	3A	1	YE4-6630500200	
19	T	变压器/Transformer	BAIYUN	IN=400V OUT=24V	80VA	1	YE7004-0005900	
20	X1	端子排/Terminal	HONEYWELL	4mm <sup>2</sup>	----	3	YE600004-03200	
21		端子排/Terminal	HONEYWELL	4mm <sup>2</sup> PE	----	1	YE600004-03500	
22	X2	端子排/Terminal	HONEYWELL	2.5mm <sup>2</sup>	----	3	YE60002503200	
23		端子排/Terminal	HONEYWELL	2.5mm <sup>2</sup> PE	----	1	YE60002503400	
24	X3	端子排/Terminal	HONEYWELL	2.5mm <sup>2</sup>	----	17	YE60002503200	
25		端子排/Terminal	HONEYWELL	2.5mm <sup>2</sup> PE	----	1	YE60002503400	
版本 Ver.C								
注: (1)表示非电控箱内材料;(2)表示除尘电机选配件;(3)表示满料报警装置选配件;(4)表示安全继电器选配件。								
			制图	版号 E	标题 SG-2324	图号		第 18 张
			设计	核 准	电元件明细表一		SG-23/30-CE-400V-E-18	共 19 张
			校对	日期 20170424	 <b>SHINI</b> 信易塑料机械股份有限公司 Shini Plastics Technologies, Inc.		比例	标准 CE
			审核	日期			机器电压 4.00V	
标记	更改前	更改后	更改人	日期			机器频率 5.0Hz	
1	2		3	4	5	6	7	8

1	2		3			4	5	6	7	8
序号/NO.	符号/Symbol	名称/Name	制造商/Manufacturer	型号/Type	规格/Specification	数量/Number	物料编号/Material number	备注/Remark		
26			HONEYWELL	2.5mm <sup>2</sup>	----	3	YE60002503200	(2)		
27			HONEYWELL	2.5mm <sup>2</sup> PE	----	1	YE60002503400	(2)		
28			HONEYWELL	2.5mm <sup>2</sup>	----	4	YE60002503200	(3)		
29			HONEYWELL	2.5mm <sup>2</sup>	----	8	YE60002503200	(4)		
A										
30	X10	金属接头/Metal joint	SHINI	PLT-254-PM	4P	1	YE68025400000	(1)(3)		
31			-----	PLT-254-RF	4P	1	YE68025400100	(1)(3)		
32	PCB	微电脑板/PCB	YUYUN	AB-02	24VAC	1	YE80022400100			
33	S1	急停按钮/Emergency stop button	SCHNEIDER	XB2BS542C	400VAC	1	YE11254200000	(1)		
34		触点块/Contact block	SCHNEIDER	ZB2BE102C	1NC	1	YE00210203100	(1)(4)		
35	S2	停止按钮/Stop button	SCHNEIDER	XB2BA22C	400VAC	1	YE11222000000	(1)		
36	S3,H1	启动按钮(带灯)/Start button	SCHNEIDER	XB2BW33B1C	24VAC	1	YE11233100000	(1)		
37		触点块/Contact block	SCHNEIDER	ZB2BE101C	1NO	1	YE00210103100	(1)(4)		
38	S4, S5	安全开关/Safety switch	SCHMERSRC	AZ15-02ZVVRK-1476	AZ-15	2	YE16147600100	(1)		
39	S4, S5	安全开关/Safety switch	SCHMERSRC	AZ16-02ZVVRK-1476	AZ-16	2	YE16147600000	(1)(4)		
40	H2	警光灯/Alarm lamp	SHINI	LED-3051	24VAC	1	YE83305100900	(1)		
41	H3	蜂鸣器/Buzzer	TEND	EA-2	24VAC	1	YE84240200000	(1)(3)		
42	MS	料位开关/Material level sensor	SIPAI	SR-80	24VAC	1	YE15802400100	(1)(3)		
43	TA2	电流互感器/Current transformer	YUYUN	-----	5-100A	1	-----		线路板自带	
44	PA	电流表/Ammeter	SFIM	DH-670	30A	1	YE25673000000	(1)		
45	M1	粉碎电机/Granulating motor	-----	5.5KW	400V 50Hz	1	-----	(1)		
46	M2	吸料机/Suction blower	-----	0.55KW	400V 50Hz	1	-----	(1)		
47	M3	除尘风机/Dust-removing blower	-----	0.25KW	400V 50Hz	1	-----	(1)(2)		
C										
D										
版本	Ver.C	注: (1)表示非电控箱内材料;(2)表示除尘电机选配配件;(3)表示满料报警装置选配配件;(4)表示安全继电器选配配件.			标题	图号	比例	第 19 张		
		制图	版号	E	SG-2324	SG-23/30-CE-400V-E-19	标准	CE	共 19 张	
		设计	核		电气元件明细表二		机	器电压	400V	
		校对	准				器	频率	50Hz	
标记	更改前	更改后	更改人	日期	日期	20170424	信易塑料机械股份有限公司 Shini Plastics Technologies, Inc.			
1	2	3	4	5	6	7			8	