

1 2 3 4 5 6 7 8

A

B

C

D

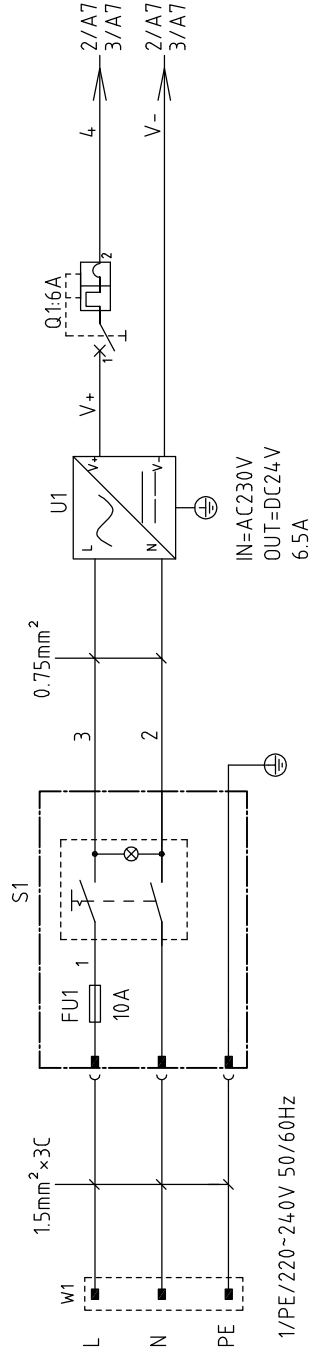

版本 Ver.A

Mark	Before modification	Modified by	Modify date	Checked by	Proofread by	Designer	Drawer	Version	0	Title	SCM-EB Circuit Diagram 1	Drawing NO.	SCM-EB-CE-230V-0-1	Scale	CE	Page	1
	After modification	Modified by	Modify date	Checked by	Proofread by	Designer	Drawer	Version	0	Approved by	SCM-EB	SCM-EB-CE-230V-0-1	Standard	CE	Totally	5	Pages
													Voltage		230V		
													Frequency		50/60Hz		
													Page		1		
													Totally		5		
													Pages		8		



1 2 3 4 5 6 7 8

A

B

C

D

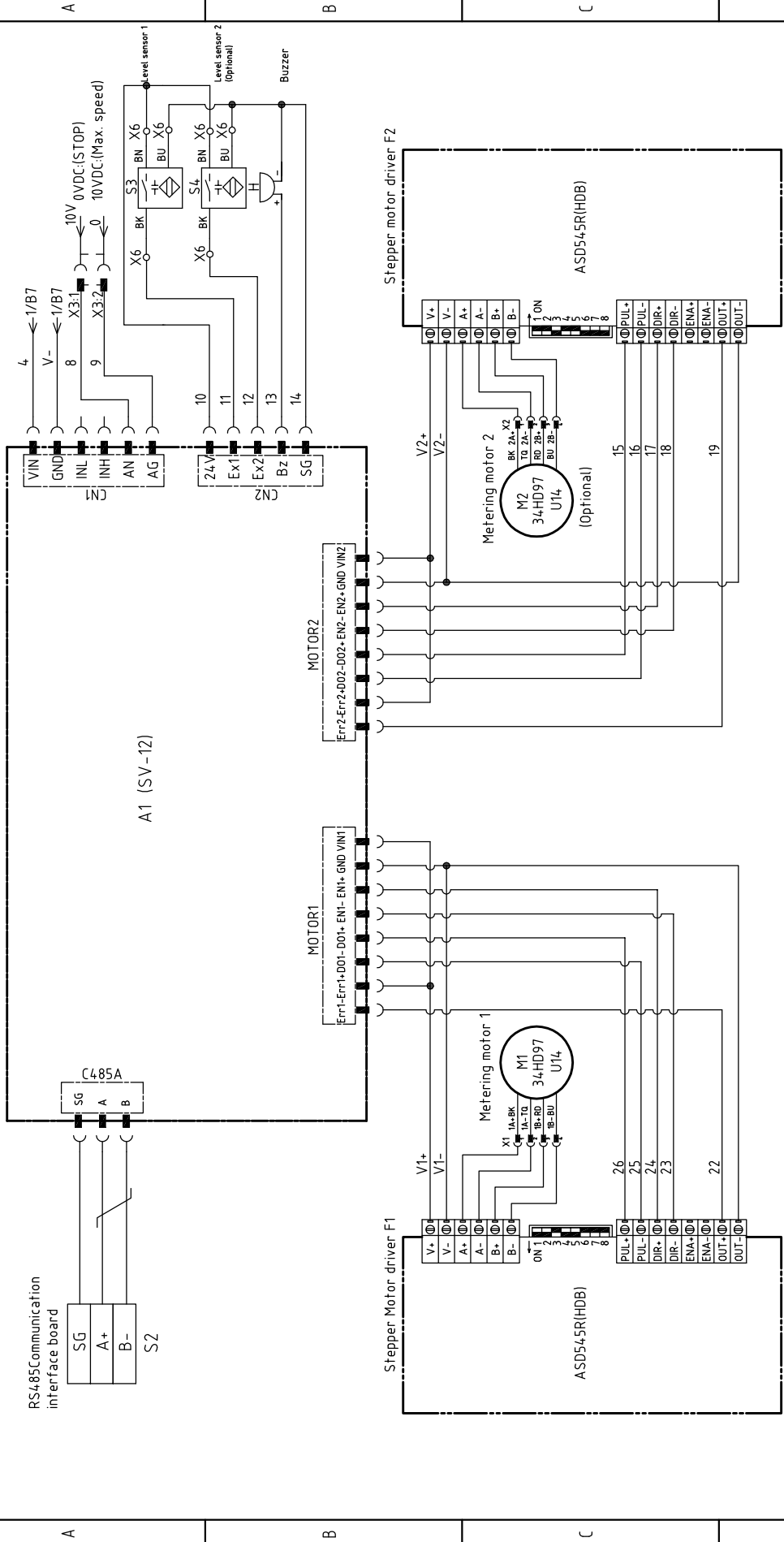

A1 (SV-12)

版本 Ver.A

Mark	Before modification	Modified by	Modify date	Checked by	Date	Proofread by	Designer	Drawer	Version	Title	Scale		Page	3
	After modification										Standard	CE		
SCM-EB-CE-230V-0-3											Voltage		230V	
SHINI 信易電熱機械股份有限公司 Shini Plastics Technologies, Inc.											Frequency		50/60HZ	
SCM-EB (Extrusion Mode) Circuit Diagram 3											Drawing NO.		SCM-EB-CE-230V-0-3	
0											Approved by			
20190828											Date			

Control screen layout

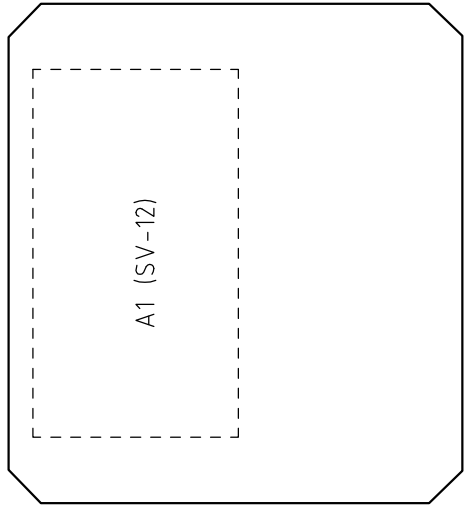

Metal plug-in layout

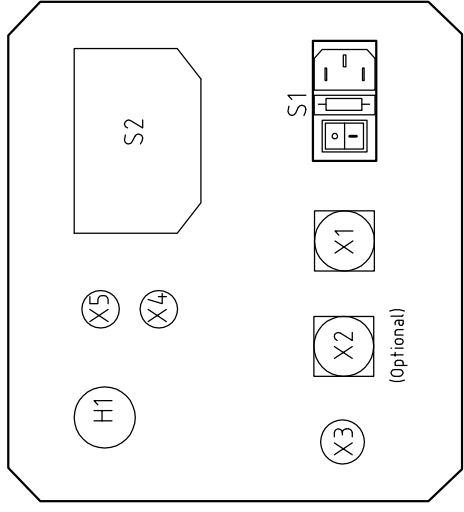

Electrical Components Layout

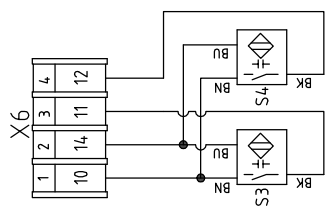
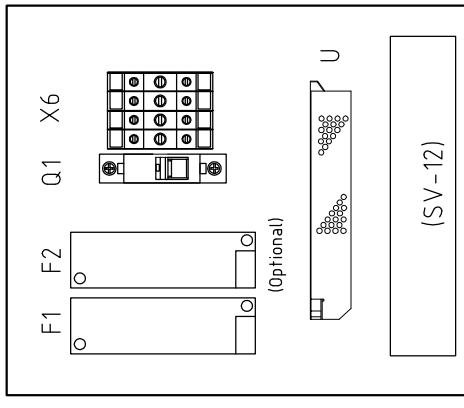

Connect to hopper 1 material level sensor

Connect to hopper 2 material level sensor(Optional)

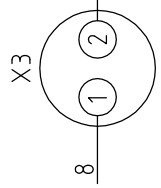

Melting/extrusion signal 2P
Connection diagram of metal connectors

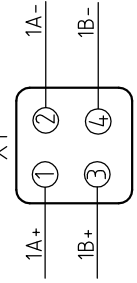

Stepper motor 1 4P
Connection diagram of metal connectors

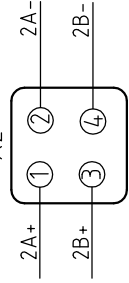

Stepper motor 2 4P
Connection diagram of metal connectors
(Optional)

- X1: Connect to metering motor 1
- X2: Connect to metering motor 1(Optional)
- X3: Connect to IMM melting signal or extruder 0-10V screw's rotational speed signal
- X4: Connect to hopper 1 material level sensor
- X5: Connect to hopper 1 material level sensor(Optional)
- S2: Communication interface
- H: Alarm buzzer
- S1: Power switch+Fuse core

版本 Ver.A

Mark	Before modification	Modified by	Date	Version	0	Title	SCM-EB	Drawing NO.	Standard	CE	Page	4
	After modification	20190828	4	Electrical Components Layout	SCM-EB-CE-230V-0-4	Standard	CE		Totally	5	Pages	50/60HZ
 <p>信易電熱機械股份有限公司 Shini Plastics Technologies, Inc.</p>												
<p>Scale: Voltage 230V, Frequency 50/60HZ</p>												

1		2		3		4		5		6		7		8	
NO.	Symbol	Name	Manufacturer	Type	Specification	Number	Material number	Remark							
1	A1	PCB	YUYUN	SV-12	24VDC	1	YE801224.05000								
2	S1	Power Line	MISUMI	APCJ-101-IFR-03	AC90-56A-53-375-2	1	YE15111300000								
3	A	Fuse Core	JIANDONG	5x20	10A 250V	1	YE46010250000								
4	W1	CE Power Line	RENYI	1.0x3P	10A	1	YE50122500000								
5		GB Power Line	YONGTAO	1.5x3C	16A	1	YE50316300000								
6	Q1	Circuit Breakers	TECO	BM-63C/1006S 1P	6A	1	YE40100600100								
7	H1	Buzzer	JINGKANG	PK-27A/29EP	24VDC	1	YE84002700000								
8	U	DC Power	LIANGYUAN	PMT-24V150W1AA	IN=115/230V OUT=24VDC 6.5A	1	YE7124.6500000								
9	X1	Heavy-duty Connector	HARTING	Han 4A-M	4P+PE	1	YE68000401300	(1)							
10		Heavy-duty Connector	HARTING	Han 4A-F	4P+PE	1	YE68000401400								
11	X2	Heavy-duty Connector	HARTING	Han 4A-M	4P+PE	1	YE68000401300	(1)(3)							
12		Heavy-duty Connector	HARTING	Han 4A-F	4P+PE	1	YE68000401400	(3)							
13	X3	Metal Connector	CHAOYI	PLT-162-RR(公)	2P	1	YE68016200100	(1)							
14			CHAOYI	PLT-162-PR(母)	2P	1	YE68016200000	(1)							
15	X4 X5	Cable Head	JUKUANG	PG9	----	2	YE67000940000								
16	X6	Terminal Board	HONEYWELL	SK2.5	----	4	YE60002503200								
17		Terminal fittings E/GK series (honeywell)	HONEYWELL	----	----	2	YE60000003900								
18	S2	Communication interface board RS-485 (double Disub-9pin connector)	YUYUN	----	----	1	YE90048501200								
19		Shell RS485(SAL-700G-A-1910)	BINCHEG	----	----	1	YR40048500000								
20	S3	Capacitance Switch	IFM	KI5082+EVS0	10~36VDC	1	YE15508200000	(1)							
21	S4	Capacitance Switch	IFM	KI5082+EVS0	10~36VDC	1	YE15508200000	(1)(2)							
22	M1	Stepper Motor	HDB	34-HD97U14-ASD545R	----	1	YM50349700000	(1)							
23	F1	Driver	HDB	S-245D	----	1	YM10024500000	(1)							
24	M2	Stepper Motor	HDB	34-HD97U14-ASD545R	----	1	YM50349700000	(1)(3)							
25	F2	Driver	HDB	S-245D	----	1	YM10024500000	(1)(3)							
版本 Ver.A		Notes: (1)Means it's not the material inside the control box. (2)Stand for level switch option. (3)It stands for optional SCM-D.													
D		Drawing NO.		SCM-EB		SCM-EB-CE-230V-0-5		Scale		CE		Page		5	
				Electrical Components List				Standard		Voltage		Totally		5 Pages	
Mark		Before modification		Modified by		Modify date		Checked by		Date		Frequency		230V	
						20190828				20190828		50/60HZ			
1		2		3		4		5		6		7		8	



信易电热机械股份有限公司
Shini Plastics Technologies, Inc.