

STM-PW-D

High Temp. Water Heater

Date: Oct. 2024

Version: Ver. I



Contents

1. General Description	6
1.1 Coding Principle.....	7
1.2 Feature	7
1.3 Options	8
1.4 Reference Formula of Mould Controllers Model Selection.....	10
1.5 Safety Regulations.....	10
1.5.1 Safety Signs and Labels.....	10
1.5.2 Signs and Labels.....	11
1.5.3 Operation Regulations.....	12
1.6 Exemption Clause.....	13
2. Structure Characteristics and Working Principle.....	14
2.1 Working Principle.....	14
3. Installation and Debugging	15
3.1 Installation Space.....	15
3.2 Pipe Connection.....	15
3.3 Power Connection.....	16
3.4 Options Installation	17
3.4.1 Installation steps for options water manifold (dewaxing)	17
3.4.2 Installation steps for options water manifold (welding)	18
4. Operation Guide	19
4.1 Machine Startup.....	19
4.2 Main Screen.....	19
4.2.1 Standby Screen.....	19
4.2.1 Operation Screen	21
4.3 Machine Start/Stop	21
4.3.1 Startup steps	21
4.3.2 Shutdown steps.....	21
4.4 User Setting.....	22
4.4.1 User Parameter Settings	22
4.4.2 Action Setting	23
4.4.3 Clock Timing.....	24
4.4.4 System Setting	25

4.4.5	Data Download.....	25
4.4.6	Advanced Setting	27
4.5	Current Fault Inquiry	34
4.6	Inquiry Screen.....	34
4.6.1	History Fault Inquiry.....	34
4.6.2	Data Inquiry	35
4.6.3	Output Inquiry	35
4.6.4	Input Inquiry.....	36
4.6.5	Version Inquiry	36
4.7	Password Management	36
4.7.1	Login.....	36
4.7.2	Password Modification.....	36
4.8	Controller Exception List	37
5.	Trouble-shooting.....	43
6.	Maintenance and Repair	46
6.1	Open the Covers.....	46
6.2	Y Type Strainer	47
6.3	Solenoid Valve	48
6.4	Pipe Heater.....	48
6.5	Bypass Valve	49
6.6	Maintenance Schedule	50
6.6.1	About the Machine.....	50
6.6.2	Installation & Inspection.....	50
6.6.3	Daily Checking	50
6.6.4	Weekly Checking.....	50
6.6.5	Trimonthly Checking.....	50
6.6.6	Half-yearly Checking	51
6.6.7	Yearly Checking	51
6.6.8	3 year Checking	51

Table Index

Table 3-1:	Cooling Water Inlet and Outlet Specification.....	16
Table 4-1:	Standby Screen Specifications	19

Table 4-2: Operation Screen Specification	21
Table 4-3: User Parameter Specification	23
Table 4-4: Project Parameter Description	28
Table 4-5: Current Fault Inquiry Screen Icon Key Description	34
Table 4-6: User and Password Function.....	36

Picture Index

Picture 1-1: Shini Mould Temp. Controller STM-PW-D.....	6
Picture 2-1: Working Principle	14
Picture 3-1: Installation Space	15
Picture 3-2: Pipe Connection	16
Picture 4-1: Startup Screen.....	19
Picture 4-2: Standby Screen	19
Picture 4-3: Operation Screen	21
Picture 4-4: User Setting Screen	22
Picture 4-5: User Parameter Screen	22
Picture 4-6: Action Setting Screen	23
Picture 4-7: Clock Timing Screen.....	24
Picture 4-8: Set Timing Switch Screen.....	24
Picture 4-9: Timer Inquiry and Modification Screen	25
Picture 4-10: System Setting Screen	25
Picture 4-11: Data Download Screen.....	26
Picture 4-12: Temp. Data Download Screen	26
Picture 4-13: Alarm Record Download Screen.....	27
Picture 4-14: Project Screen	27
Picture 4-15: Project Parameter Setting Screen	27
Picture 4-16: Password Mgmt. Screen.....	33
Picture 4-17: Interface Specification	33
Picture 4-18: Current Fault Screen	34
Picture 4-19: History Fault Inquiry Screen	35
Picture 4-20: Data Inquiry Screen	35
Picture 4-21: Output Inquiry Screen.....	35
Picture 4-22: Input Inquiry Screen.....	36

Picture 4-23: Version Inquiry Screen	36
Picture 4-24: Modifying User Password Screen.....	37
Picture 6-1: Open the Covers 1	47
Picture 6-2: Open the Covers 2	47
Picture 6-3: Open the Covers 3	47
Picture 6-4: Y Type Strainer	48
Picture 6-5: Solenoid Valve	48
Picture 6-6: Pipe Heater Cleaning	49
Picture 6-7: Bypass Ball Valve	50

1. General Description



Read this manual carefully before operation to prevent damage of the machine or personal injuries.

STM-PW-D series high temp. water heaters are used to heat up the mould and maintain temperature, they can be used in other similar applications as well. High temp. water from mould through high-temp. heating pipe after it is pressurized by pump returns to the mould, which is cooled indirectly for heating and constant temperature purpose. With PID temperature control, it could ensure stable temperature control with accuracy reaching $180\pm 0.5^{\circ}\text{C}$.



Picture 1-1: Shini Mould Temp. Controller STM-PW-D

1.1 Coding Principle

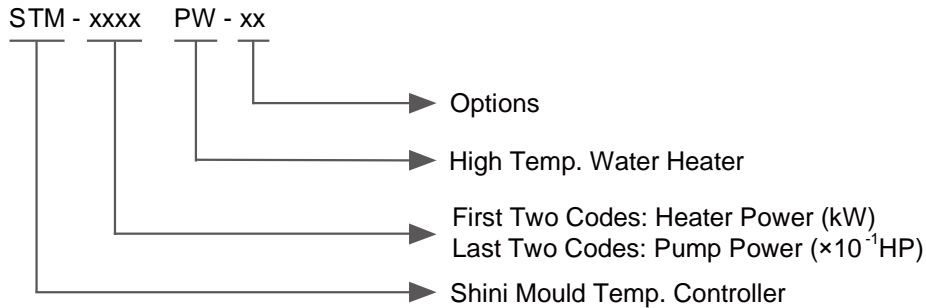

1.2 Feature

- 1) P.I.D. multi-stage temperature control system can maintain a mould temperature with accuracy of $\pm 0.5^{\circ}\text{C}$.
- 2) SSR solid status relay control;
- 3) Adopts high efficiency water cycle magnetic pump, with which precise moulds and mould loop with minor diameter can achieve precise temperature control and high efficient heat exchange. Pump inside adopts stainless steel to avoid explosion.
- 4) Multiple safety devices including power reverse phase protection, pump overload protection, overheat protection and low level protection that can automatically detect abnormal performance and indicate this via visible alarm.
- 5) The highest temperature can reach 180°C .
- 6) Equipped with high pressure protection, safety pressure relieving, automatic water supplying and air exhausting.
- 7) Plate exchanger indirect cooling ensures precision temp. control, and the system can achieve quick heat exchanging with the low viscosity of water.
- 8) RS485 communication function is standard.
- 9) Equipped with water level probe and high-pressure plunger pump .The water level probe can accurately detect the water level . When the system level is too low, the plunger pump to supply the high pressure system with water to avoid pipe dry burning.
- 10) Standard equipped with buzzer.
- 11) Insulated control box can prolong the service life inside the electrical equipment.

- 12) Adopt 4.3" touch screen with dual independent displays for easy human operation.
- 13) Equipped with pressure sensor for intuitive display of the controller;
- 14) USB interface can record and back up local data.
- 15) Adopt non-contact heater, and the heater will not be affected by water quality.

1.3 Options

- 1) For models optional with magnetic filter to prolong the service life the magnetic pump, and add "MF" at the end of the model code.
- 2) For models optional with mould return water temperature display function, add "TS" at the end of the model code.
- 3) For models with optional auto water purging function, add "MA" at the end of the model code.
- 4) For models with optional leakage protection switch, add "CB" at the end of the model code.

All service work should be carried out by a person with technical training or corresponding professional experience. The manual contains instructions for both handling and servicing. Chapter 6, which contains service instructions intended for service engineers. Other chapters contain instructions for the daily operator.

Any modifications of the machine must be approved by SHINI in order to avoid personal injury and damage to machine. We shall not be liable for any damage caused by unauthorized change of the machine.

Our company provides excellent after-sales service. Should you have any problem during using the machine, please contact the company or the local vendor.

Shini Hotline Service:

Headquarter and Taipei factory:

Tel: + 886 (0)2 2680 9119

Shini Plastics Technologies (Dongguan), Inc.:

Tel: +86 (0)769 8331 3588

Shini Plastics Technologies (Pinghu), Inc.:

Tel: +86 (0)573 8522 5288

Shinden Precision Machinery (Chongqing), Inc.:

+86 (0)23 6431 0898

1.4 Reference Formula of Mould Controllers Model Selection

Heater Power (kW) = mould weight (kg) × mould specific heat (kcal/kg °C) × temperature difference between mould and environment (°C) × safety coefficient / heating duration / 860

Note: safety coefficient can select a value from 1.3 to 1.5.

Flow Rate (L/min) = heater power (kw) × 860 / [heating medium specific (kcal/kg °C) × heating medium density (kg/L) × in/outlet temperature difference (°C) × time (60)]

Note: Water specific heat = 1kcal/kg °C

Heating medium oil specific heat = 0.49kcal/kg °C

Water density = 1kg/L

Heating medium oil density = 0.842kg/L

1.5 Safety Regulations

Strictly abide by the following safety regulations to prevent damage of the machine or personal injuries.

1.5.1 Safety Signs and Labels



Danger!

The unit is designed to endure high temp, and high pressure. For safe operation, do not remove the covers or switches.



Attention!

The unit should be operated by qualified personnel only.

During operation, avoid wearing gloves or clothes that may cause danger.

Turn off main switch when power supply is off.

Stop the unit when there may be power supply problems caused by static electricity.

Put on safety gloves and shoes during installation or relocation.

Components from our company can only be used for replacement.



Warning!

Do not touch the switch with wet object or hands.

Do not use the machine before fully aware of its performance.

Be careful not to touch or hit the switch or sensor.

Please keep enough operation space, and keep away obstacles.

To avoid producing statics, clean the floor from oil or water to keep a dry environment.

Protect the machine against severe vibration or collision.

Do not remove safety signs or make it dirty.

Drunken, medicine-taking, or men without proper judgement should not operate the machine.



Warning!

All screws that used for installing electrical components in the control box must be locked tightly, which doesn't need regular inspection!

1.5.2 Signs and Labels

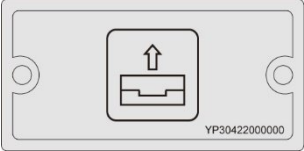
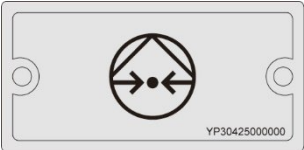
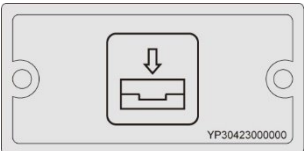
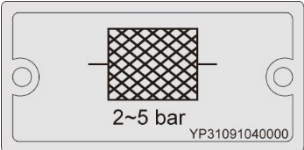
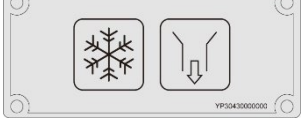
	<p>From mould: connector for circulating water/oil coming from mould.</p>
	<p>Pump pressure meter: indicating actual pressure of system.</p>
	<p>To mold: connector for circulating water/ oil to go to mould.</p>
	<ol style="list-style-type: none"> 1. To maintain temperature consistency, cooling water pressure must be higher than 2 bar at all time, but should never exceed 5 bar in any case. 2. Clean Y-shape Cooling Water Strainer periodically to ensure perfect cooling capacity.
	<p>Water outlet: drainage outlet.</p>

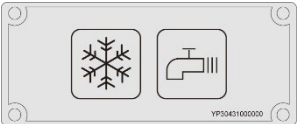
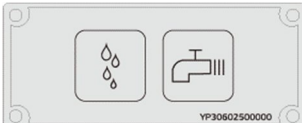
	<p>Water inlet: inlet for replenishing water and cooling water.</p>
	<p>Purified water inlet</p>

1.5.3 Operation Regulations

- 1) Before operation, make sure that cooling water is clean soft water without pollutants.

Low quality water brings limescales, which may cause problems.

If the water quality is not good, the heating pipe will break, the pump impeller will damage, and the flow will reduce, thus leading to the temp. can not rise.

- 2) If problems of drainage or bad temperature control are noted, please clean solenoid valve and cooling water inlet and outlet.
- 3) Do not move the unit when it is in operation.
- 4) When in need of repairing, wait until oil temperature falls below 30°C.
- 5) The water heater has pump overload device: When it is overloaded, the pump and pipe heater will both stop. At this time, check the cause of pump overload (phase loss, pipe blockage, bearing damage, etc.). After everything is normal, reset the overload protector (RESET) to resume work.
- 6) The water heater equips pump overheat protector:
- 7) After everything becomes normal, cool the pump to normal temp., and then resume its operation.
- 8) Before turn off the pump, wait until water temp. falls below 50°C. Or the life of the unit would be affected.
- 9) To ensure the stability of heating temp., the cooling water pressure should be 2~5kg/cm².
- 10) If the working temp. is below 100 °C, it can set the pressure switch to 1.5~2bar; If the working temp. is set at 100 °C ~180 °C, it's recommended to set the value to 2.8bar; The pressure switch parameters have been set before delivery. If the cooling water pressure is too low,

please adjust the pressure switch set value within the specified parameter range to achieve the effect (But it may affect the working temp. or lead to unstable temp. control), but don't change it unauthorizedly. As a result, it may result in failure, which will not be included in the warranty.

- 11) Please connect the cooling water outlet with high temperature resistant pipe when temperature is above 100°C.

1.6 Exemption Clause

The following statements clarify the responsibilities and regulations born by any buyer or user who purchases products and accessories from Shini (including employees and agents).

Shini is exempted from liability for any costs, fees, claims and losses caused by reasons below:

1. Any careless or man-made installations, operation and maintenances upon machines without referring to the Manual prior to machine using.
2. Any incidents beyond human reasonable controls, which include man-made vicious or deliberate damages or abnormal power, and machine faults caused by irresistible natural disasters including fire, flood, storm and earthquake.
3. Any operational actions that are not authorized by Shini upon machine, including adding or replacing accessories, dismantling, delivering or repairing.
4. Employing consumables or oil media that are not appointed by Shini.

2. Structure Characteristics and Working Principle

2.1 Working Principle

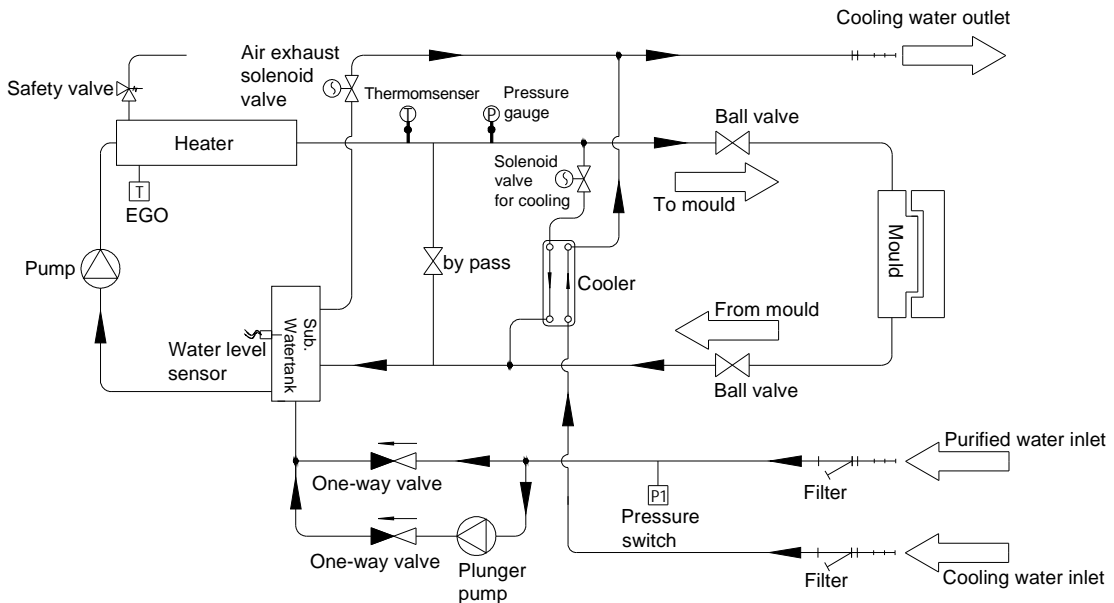

Picture 2-1: Working Principle

The high-temp. water from the mould returns to the pump inlet through the pipe, pressurized by the pump and then is sent to the heater, which is delivered to the mould after being heated by the pipe heater, so as to circulate. In this process, if the level sensor detects that the liquid level drops to the set value, the machine will start the plunger pump to refill water for 30 secs., and if it is still at low liquid level after 30 secs., the machine will give alarm to shut down. If the water temp. is too high, the system will start the cooling solenoid valve, and the cooling water will enter the double sleeve pipe on the heating tank to cool down the high-temp. water and decrease the high water temp., so as to achieve the purpose of constant temp. control. If the water temp. keeps increasing and it reaches the EGO (overheat protector) set value, the system will give high temp. alarm and shut down. When the system pressure is too high and it exceeds the set value of high pressure switch, the machine will release the pressure. If the pressure continues to rise and reaches the safety valve set value, the mechanical safety valve will open to release the system pressure.

3. Installation and Debugging

3.1 Installation Space

During installation of the machine, keep at least 500mm installation space around the machine as shown by the picture. Do not install the machine in a position crowded with other objects. This would cause inconvenience to operation, maintenance and repair.

Do not sit on the machine.

Keep away flammable and explosive goods.

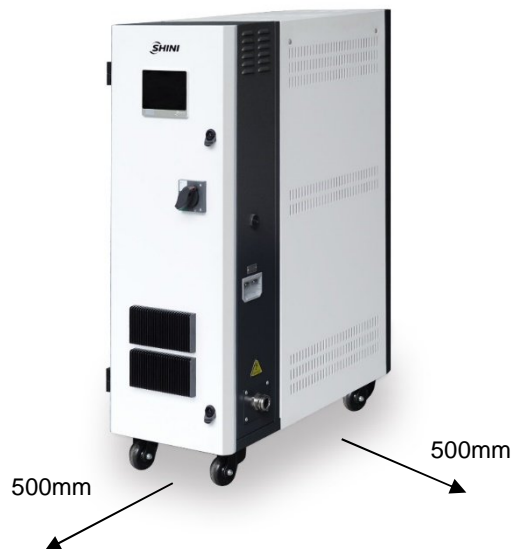

Picture 3-1: Installation Space

3.2 Pipe Connection

- 1) The inlet and outlet specifications of the heating tank and return water pipe
STM-1220PW-D: 3/4" PT female thread
- 2) Cooling Water Connection
Connect the cooling water inlet to the clean water source, the system inlet to the clean water source, and the cooling water outlet to the

drainage port, and then turn on the water source. The cooling water flow shall not be less than 10L/Min.

Refer to GB1576-2001 Water Quality for Industrial Boilers

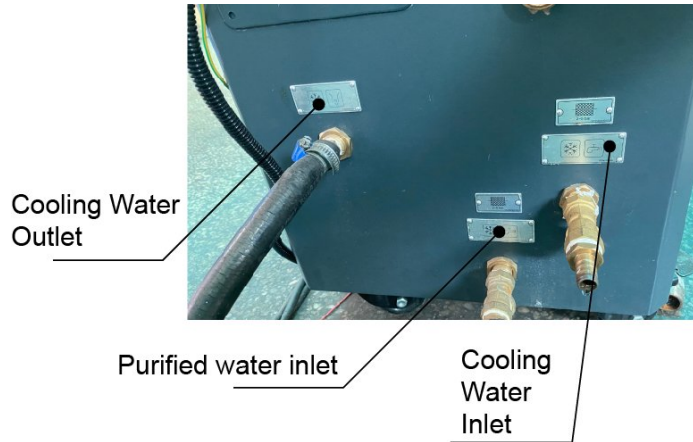

Picture 3-2: Pipe Connection

Table 3-1: Cooling Water Inlet and Outlet Specification

Model	Cooling Water Inlet	System Water Inlet	Cooling Water Outlet	Connector Type
STM-1220PW-D	Φ 13mm (ext. diameter)	Φ 16mm (ext. diameter)	Φ 13mm (ext. diameter)	Pagoda

Note: The cooling water inlet and outlet are shown in the figure below, and don' t connect it reversely! When the service temp. is above 100 °C, the cooling water must be connected with high temp. resistant pipes.

3.3 Power Connection

The water heater needs well electrical grounding to ensure safe running of the electrical equipments.

- 1) Make sure the voltage and frequency of the power source comply with those indicated on the manufacturer nameplate that attached to the machine.
- 2) Power cable and earth connection should conform to your local regulations.
- 3) Use independent electrical wires and power switch. Diameter of electrical wire should not be less than those used in the control box.

- 4) The power cable connection terminals should be tightened securely.
- 5) The machine requires 3-phase 4-wire power source, connect the power lead (L1, L2, L3) to the live wires, and the earth (PE) to the ground.
- 6) Power supply requirements:
Main power voltage: +/- 5%
Main power frequency: +/- 2%
- 7) ***Please refer to electrical drawing of each model to get the detailed power supply specifications***

3.4 Options Installation

3.4.1 Installation steps for options water manifold (dewaxing)

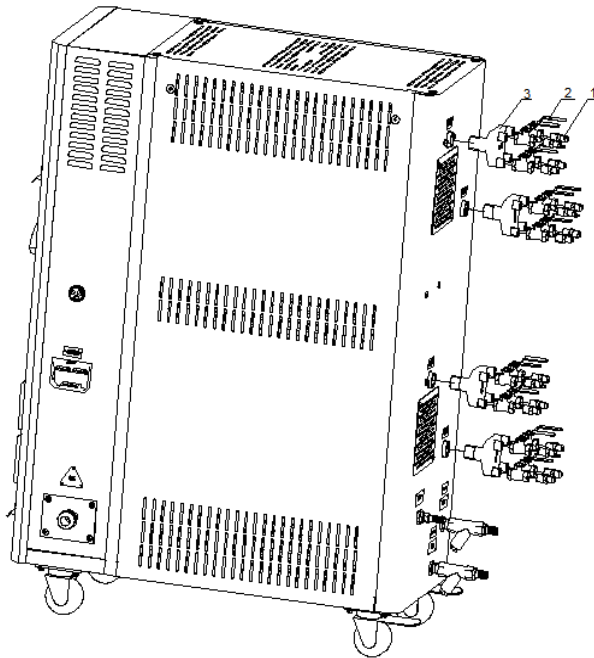

- 1) Install the Tonflon pipe connector onto the ball valve;
- 2) Install the ball valve with a Tonflon pipe connector onto the dewaxing water flow regulator;
- 3) Install the water flow regulator onto the machine;
- 4) Install the Teflon pipe onto the Tonflon pipe connector;

Note: For the operating temperature not higher than 200°C, Teflon with temperature resistance 200°C is usable; for the

operating temperature from 200 to 300 °C, must use Teflon with temperature resistance 300 °C.

3.4.2 Installation steps for options water manifold (welding)

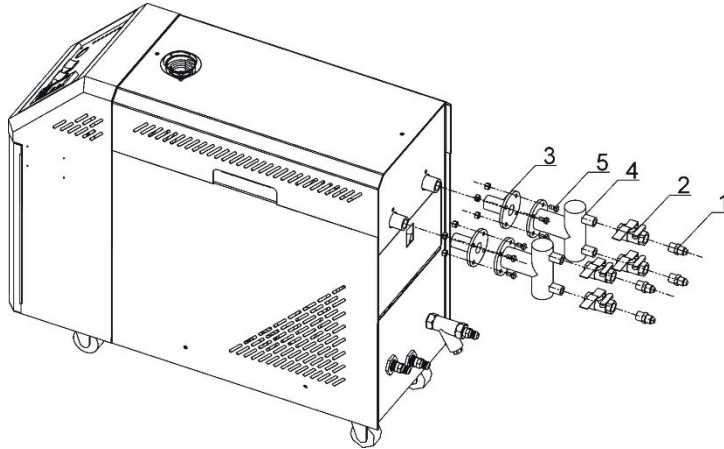

- 1) Install copper joint to the level valve.
- 2) Install level valve with copper joint to the welding water manifold.
- 3) Install water manifold to the machine.
- 4) Connect water manifold with manifold joint via screws.
- 5) Install Teflon to copper joint.

Note: For the operating temperature not higher than 200 °C, Teflon with temperature resistance 200 °C is usable; for the operating temperature from 200 to 300 °C, must use Teflon with temperature resistance 300 °C.

4. Operation Guide

4.1 Machine Startup

After the system is powered on, the panel displays the startup screen, as below:



Picture 4-1: Startup Screen

4.2 Main Screen



4.2.1 Standby Screen



Picture 4-2: Standby Screen

Table 4-1: Standby Screen Specifications

No.	Icon	Name	Function Type	Description
1		Fault inquiry	press key	1. When the system failure occurs, it will flash on the main interface. Click to enter and query current fault information;

				2. When there's no fault in the system, press to enter the "Historical Faults" query.
2		Setting	press key	Enter the user setting screen
3		Switch	press key	 standby status,  running status
4		Forced cooling	button	 Press to activate the forced cooling function  Press to close the forced cooling function
5	PV	Actual temp. value	display only	Used to display the actual value of the controlled temp..
6	SV	Set temp. value	press key	Click this button to set the heating temp..
7	1	Machine No.1	display only	It displays machine No.1.
8	OFF	Standby	display only	Display machine running status.
9	Inlet Temp	Return medium temp.	display only	Display the medium temp. returned from the mould, which is optional function. When this function is not optional, it displays gray.
10	Outlet P	Outlet medium pressure	display only	Display the medium real-time pressure, and the machine can exhaust the air and release the pressure based on actual pressure.
11	2	Machine No.2	display only	It displays machine No.2.I

4.2.1 Operation Screen

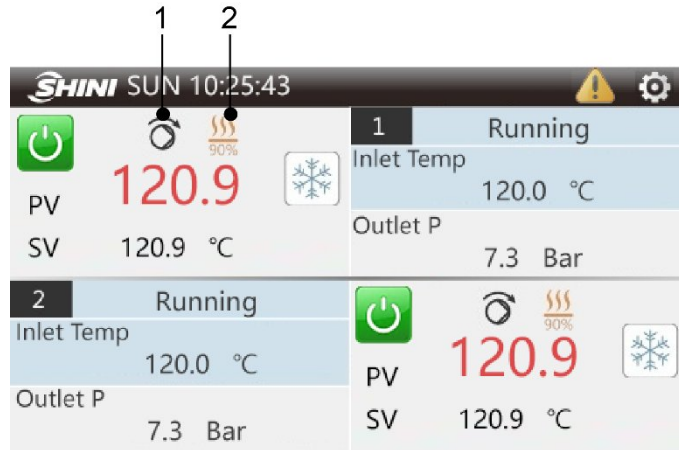

Picture 4-3: Operation Screen

Table 4-2: Operation Screen Specification

No.	Icon	Name	Description
1		Pump rotating /reverse rotating	This icon indicates the unit starts pump rotating/reverse rotating.
2		Heating/cooling	This icon indicates the unit starts the temp. heating control. The bottom is heating percentage.

4.3 Machine Start/Stop

4.3.1 Startup steps

- 1) Please check if all pipelines are connected properly first, including cooling water inlet and outlet pipes and heating medium inlet and outlet pipes, and if all inlet and outlet valves are open.
- 2) Turn on the switch, and please check whether the input voltage and frequency meet the nameplate requirement.
- 3) Turn on the main power switch on the door plate, and the screen will light up;
- 4) Click on the SV on the controller to set the target temp., and at last click on the switch button to start the machine.

4.3.2 Shutdown steps

- 1) Press the<Forced cooling>button to turn off the heating output and turn on 100% cooling.

- 2) When the temperature drops below 50 °C, press the <Forced cooling> button to turn off the forced cooling, and then press the <Run/Stop> button to stop the machine.
- 3) Turn the main power switch to OFF.

Attention:

When the main power switch is ON, please be noted the the risk of electric shock!

Attention:

Make sure the pump running direction is correct!

Attention: In order to reduce machine damage and extend its lifespan, please turn on and off it following correct steps!

4.4 User Setting

In the "Operation" screen, click the < Setting > button to enter the "User Setting" screen:



Picture 4-4: User Setting Screen

4.4.1 User Parameter Settings

In the "User Setting" screen, click the < User Parameters > button to set user parameters:

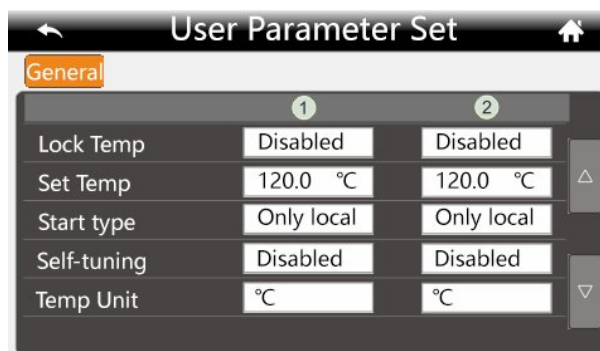

Picture 4-5: User Parameter Screen

Table 4-3: User Parameter Specification

Parameter	Initial Value	Setting Range	Unit	Remarks
Locking temp.	disable	disable- use		When selecting the "use", it's not allowed to set temperature on the main interface.
Setting temp.	80.0	0-180.0	°C	
Start/stop mode	local	local~local+ remote ~ remote		Local: unit startup/shutdown can only be controlled locally. Local + remote: unit startup/shutdown can only be controlled locally and remotely. Remote: unit startup/shutdown can only be controlled remotely.
Auto turning	disable	disable- enable		
Temp. Unit	°C	°C/°F		Temp. display unit
Decimal point	0.1	1/0.1		The main screen has mini. temp. unit display

4.4.2 Action Setting

In the "User Setting" screen, click the < Action Setting > button to enter the screen below:



Picture 4-6: Action Setting Screen

4.4.2.1 Reverse Emptying

After the machine stops, it can start pump rotating and exhaust valve only when the PV is less than the [exhaust temp.]; If the reverse rotating time is set to 0, it requires manual start stop or automatic running (The factory default value for reverse rotating time is 60S, please refer to the project parameter table for specific settings) to stop automatically.

4.4.3 Clock Timing

Click the < Clock Timing > button in the user setting screen to enter the following screen:



Picture 4-7: Clock Timing Screen

Timing main switch: used to select the timing on/off function, and it can inquire on the main screen if the timing is switched on. It can set six groups of time in total, and each group of time can be selected through the switch: disable, timing on or off.

After timing main switch is turned on, it can set the timing on/off, as shown in the picture below:

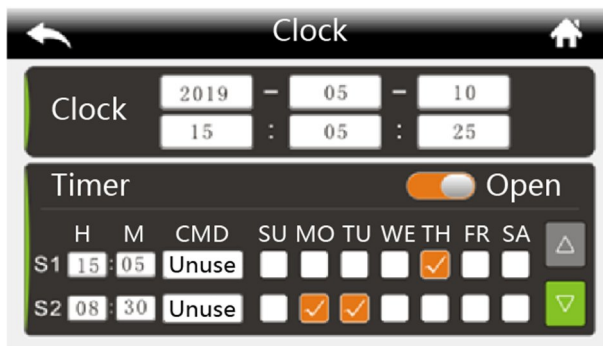

Picture 4-8: Set Timing Switch Screen

If the "Timing Main Switch" is set to "ON", press the < Clock > button in the "Operation" screen to enter the Timing Inquiry and Modification Screen.

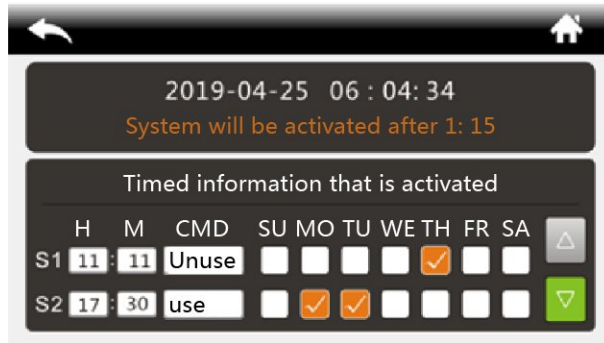

Picture 4-9: Timer Inquiry and Modification Screen

4.4.4 System Setting

In the "User Setting" screen, click the < System Setting > button to enter the picture below:

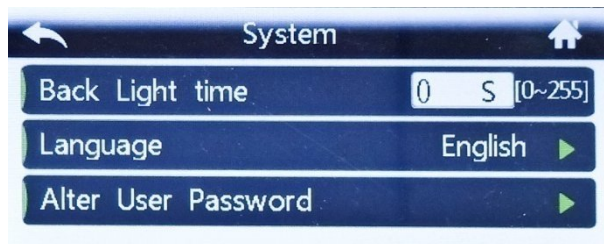

Picture 4-10: System Setting Screen

Set the backlight time: setting range is 0 ~ 255 secs.

Language: Chinese or English

The default user password is 123. See "Password Modification" for details;

4.4.5 Data Download

When downloading data, please use the U disk format: FAT32, and the recommended U disk capacity is 16g or below.

In the user setting screen, click the < Data Download > button to enter the following screen:



Picture 4-11: Data Download Screen

4.4.5.1 Temp. Data Download



Picture 4-12: Temp. Data Download Screen

Local data backup: copy the temp. data on the display board to the U disk (the data of display board can be saved for up to 48 hrs.). Copy the temperature data stored on the display board to the USB flash disk. Insert the U disk, wait until the "U disk" displays "connected" status, and then follow the prompts. Other operations are prohibited during the download process.

Real-time data recording: After inserting the U disk and starting the real-time data recording function, then the temp. data will be updated in real time and stored in the U disk automatically, and the recording will be interrupted after unplugging the U disk. Operations on other screens are available during recording.



Attention!

After data export, a folder/SF51XXX will be created in the U disk root directory, and the data will be saved in Excel.

4.4.5.2 Alarm Record Download

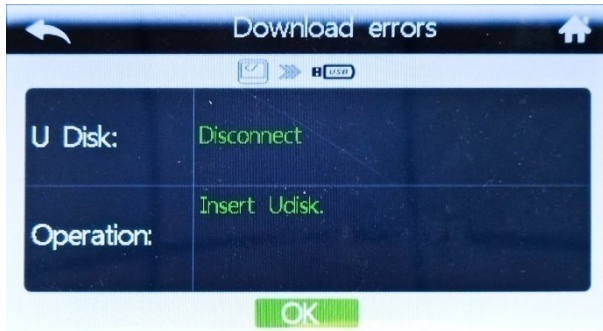

Picture 4-13: Alarm Record Download Screen

4.4.6 Advanced Setting

4.4.6.1 Project Setting

In the "User Settings" screen, click the < Advanced Setting > button and enter the password to enter the "Project" screen.



Picture 4-14: Project Screen

In the "Project" screen, click the < Project Parameter > button to enter the project parameter setting



Picture 4-15: Project Parameter Setting Screen

The detailed description of each project parameter is as below Table:

Table 4-4: Project Parameter Description

	Parameter Name	Initial Value	Setting Range	Unit	Remarks
PID	Control response regulation Ar	12.0	1~30		Adjust the PID control response
	Heating proportional band	8.0	0.1~200.0℃	℃	
		46.4	32.2-392.0		
	Cooling proportional band PC	3.0	0.1~20.0		Multiples of heating proportional band
	Integral time Ti	100.0	1~3600	sec.	
	Derivative time Td	12.0	0~3600	sec.	
	Heating cycle T	15.0	1~300	sec.	Output cycle of electric heating
	Cooling cycle TC	15.0	1~300	sec.	Output cycle of cooling valve
	Overlap zone db	0.0	-30.0~30.0	℃	For high-temp. water heater, db is set to a positive number (such as 0.5 ℃) generally.
0.0		-54.0~54.1	°F		
Running Type	Startup water supply time	60.0	0~600	sec.	Start forced water supply time
	Water supply delay time	10.0	0~600	sec.	After water supply, delay this time and stop
	Shutdown temp.	35.0	0~60.0	℃	Forced cooling shutdown temp.: cool down to this temp. and stop
		95.0	32.0-140.0	°F	Note: If pressing the OFF button, it can turn off the unit directly without cooling.
	Emptying time	0 sec.	0-600 secs.	sec.	Reverse emptying action:
	Emptying temp.	60.0	0-120.0	℃	Notes: The reverse emptying action can be started only when the machine is stopped and PV temp. is lower than the [emptying temp.]. When the 【emptying time】 is 0, the emptying will not be affected by the time.
		140.0	32.0-248.0	°F	
Auxiliary heating	5.0	0-60.0	℃	1. 【Auxiliary heating output temp.	

	output temperature difference	9.0	0-108.0	°F	<p>difference】 =0: Only use the main heating output</p> <p>2. 【Auxiliary heating output temp. difference】 ! =0:</p> <p>1) When the control temp. is lower than the (set temp. - 【auxiliary heating output temp. difference】) difference, start the heating and auxiliary heating output simultaneously to increase the temperature quickly in a short period of time.</p> <p>2) When the control temp. is greater than or equal to the (set temp. - 【auxiliary heating output temp. difference】) difference, turn off the auxiliary heating.</p>
	Exhaust valve opening time	0.5	0.0-99.0	sec.	Exhaust solenoid valve opening time
	Plunger pump start temp.	100.0	0.0-180.0	°C	Use a plunger pump to supply water and start the temp..
		212.0	32.0-356.0	°F	Use the plunger pump to supply water only when it reaches the temp.
Running	Plunger pump opening time	10.0	0-180	sec.	The plunger pump must be started at intervals.
	Plunger pump stop time	10.0	0-180	sec.	
	Probe spe.	K Type	K type thermocouple/ PT100	/	
	The number of probes	control circuit	Control loop ~ control+ return medium ~control +mould ~control +return medium +mould	/	<p>Control circuit: Control temp. probe only</p> <p>Control + return medium: control temp. + return medium temp.</p> <p>Control + mould: control temp. + mould temp.</p> <p>Control+mould+mould: control temp. + return medium temp. + mould temp.</p>

	Temp. rise and pressure release cycle	0	0-250	sec.	The exhaust valve opens periodically to release pressure.
	Insulation and pressure release cycle	0	0-100	min.	
Fault	3-phase power detection	Use	disable / use		Whether it uses the on-board 3-phase power detection;
	Return medium deviation alarm	0.0	0-50.0	°C	1) Return medium temp.–medium output temp. > 【 return medium temp. deviation 】 , delay 【 temp. deviation alarm delay 】 secs., it alarms “Large return medium temp. difference”, make auto reset. 0: disable 2) After modifying [SV] or forced cooling, this fault will not be solved in previous temp. rises / drops.
		0.0	0-90.0	°F	
	Different mould temp. alarm	0.0	0-50.0	°C	1) Return medium temp. –medium output temp. > 【 return medium temp. deviation 】 , delay 【 temp. deviation alarm delay 】 secs., it alarms “Large return medium temp. difference”, make auto reset. 0: disable 2) After modifying [SV] or forced cooling, this fault will not be solved in previous temp. rises / drops.
		0.0	0-90.0	°F	
	Different temp. alarm delay	5	0-360	sec.	Temp. difference alarm delay time
	Low temp. deviation alarm	0.0	0-50.0	°C	【SV】 – PV >【Low temp. deviation alarm 】 delay two secs., it alarms low temp., 【SV】 – PV < 【low temp. deviation alarm 】 , it will reset the fault automatically. When 【Low temp. deviation alarm 】=0 . this function is disabled.
0.0		0-90.0	°F		
High temp. deviation alarm	0.0	0-50.0	°C	PV – 【SV】 > 【High temp. deviation alarm 】 delay two secs., it alarms high temp., , PV – 【SV】 < 【High temp. deviation alarm 】 , it will reset the fault automatically. When 【High temp. deviation alarm 】=0 , this	

					function is disabled.
Fault		0.0	0-90.0	°F	
	Low flow alarm	0.0	0-100	L/min	Use flow sensor, the medium flow is lower than the [Low flow alarm], it delays two secs., and alarms "Low flow"; 0: disable
	High pressure alarm	0.0	0-50	bar	Use pressure sensor, the medium pressure is high than the [High pressure alarm], it delays two secs., and alarms "High pressure"; 0: disable
	Heater alarm	0.0	0~99.9	min.	1. If the machine fails to reach the set temp. of - 5 °C within the [heater alarm] time, it will give the "heater alarm", and continue to control the temp. Manual reset. 2. Set to 0, disable the limit detection.
	Overheat tripping temp. difference	5.0	0~100	°C	PV - 【SV】 > 【overheat trip output temp. difference】 , open the circuit breaker, the EGO will alarm;
		9.0	0-180	°F	
	Interference alarm	0.0	0~200	°C / sec.	1. Monitor temp. variation trend 2. The temp. rises or drops exceeds the 【Interference alarm temp.】 per second, it will give "Interference Alarm", and reset the fault automatically. 3. Set to 0: disable.
		0.0	0-360.0	°F / sec.	
Water supply alarm time	90	0-300	sec.	If it counts the time from the failure signal of high water level, and the water supply exceeds the [water supply alarm time], it will give "low liquid level" alarm and shut down.	
High pressure alarm time	5	0-99	sec.	When the high pressure switch receives a high pressure signal, the exhaust valve will open according to the set opening time. If the 【high pressure alarm time】 continues and it is still in the high pressure status, it will give the high pressure alarm.	
Assist	Control temp.	0.0	-30.0~30.0	°C	Compensate the measurement error of the

	compensation	0.0	°F	°F	medium output temp.
	Return medium temp. compensation	0.0	-30.0~30.0	°C °F	Compensate the measurement error of the return medium temp.
	Mould medium temp. compensation	0.0	-30.0~30.0	°C °F	Compensate the measurement error of the mould temp.
	Analog quantity AI1 compensation	0.0	0~10	bar	Compensate the pressure measurement error
	Analog quantity AI2 compensation	0.0	-30.0~30.0	L/min	Compensation flow measurement error
	Comm. address	0	0-32		Comm. basic info. setting
	Baud rate	19200	4800, 9600, 19200		
	Check bit	No parity	No parity, even parity check, odd parity		
	Stop bit	1 bit	1 bit, 2 stop bits		
	Comm. address set	SHINI	SHINI, GBT		
Maintenance	Unit maintenance time	0	0-3000	hr.	When the setaccumulative running time is greater than [unit maintenance time], it alarms" Unit Maintenance Fault".
	Accumulative total running time (hr.)	0	0-3000	hr.	
	Accumulative total running time (min.)	0	0-59	Min.	

In the "Project" screen, click <Password Mgmt.> to enter the password mgmt. settings.



Picture 4-16: Password Mgmt. Screen

- 1) Project password modification
The default value of the project password is 3588. See "Password Modification" for details.
- 2) Clear the user password.
It can clear the user password with one click.

4.4.6.2 Shini Communication Method

- 1) Interface specification and communication definition:

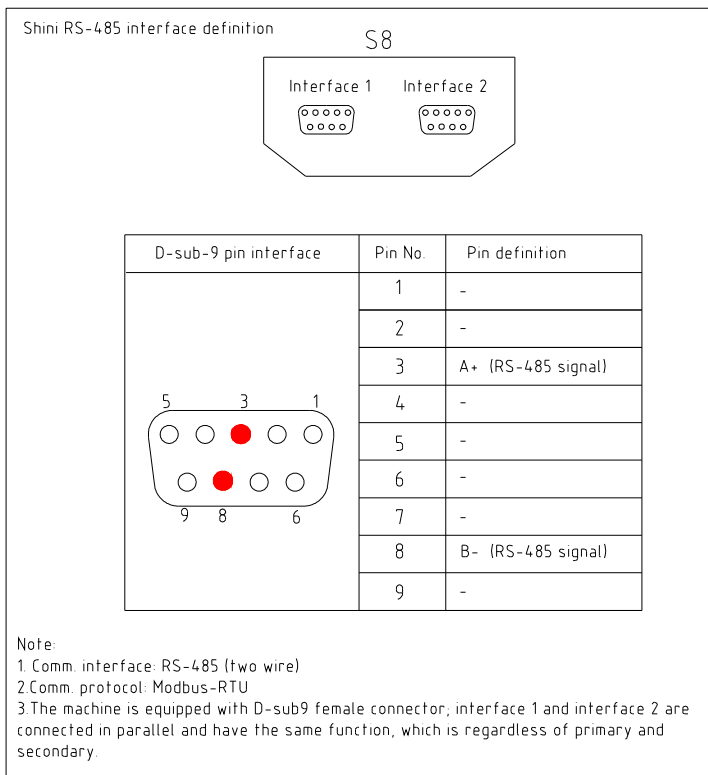

Picture 4-17: Interface Specification

Comm. Protocol:

Communication parameters can be set in "Engineering Settings" - Engineering Parameters - "Auxiliary".

Built-in Modbus-Rtu protocol.

Note:

The communication address, Baud, check bit and stop bit are adjusted according to the actual demands.

2) Comm. address set selection:

SHIINI(default):The address definition of Shini controller (as shown in the Appendix).

4.5 Current Fault Inquiry

When the unit fails, in the "Operation" screen, the < Fault Inquiry > button will flicker. At this time, click the < Fault Inquiry > button to silence and enter following screen:

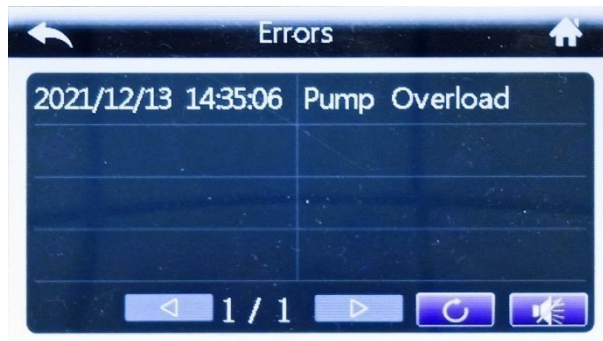

Picture 4-18: Current Fault Screen

Table 4-5: Current Fault Inquiry Screen Icon Key Description

Press Key	Key Name	Description
	Fault reset	After trouble-shooting, press this key to reset the fault.
	Silence	Eliminate the system alarm sound
	Page up	Turn the page to query the fault information, gray key can't be pressed, and green key can be pressed.
	Page down	Turn the page to query the fault information, gray key can't be pressed, and green key can be pressed.

4.6 Inquiry Screen

4.6.1 History Fault Inquiry

When there is no fault currently, click the < Fault Inquiry > button in the "Operation" screen to enter the history fault inquiry.

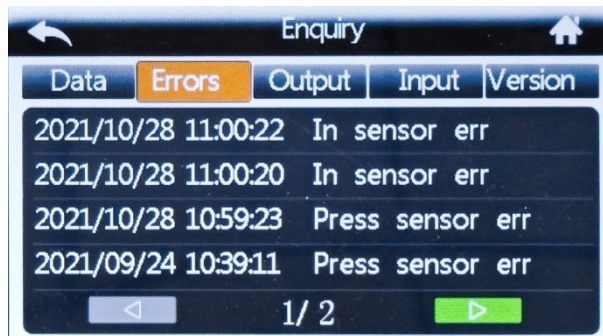

Picture 4-19: History Fault Inquiry Screen

4.6.2 Data Inquiry

It can check all probes' temperature, pressure of current system, and query the system running time and other data:

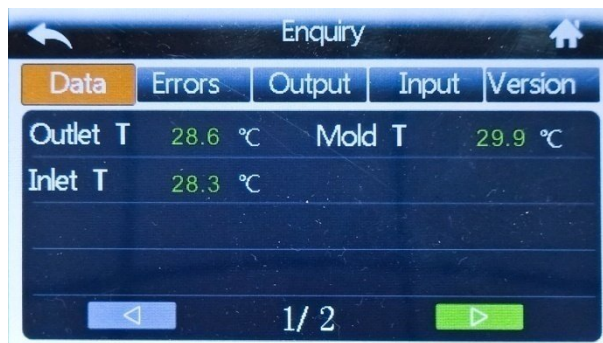

Picture 4-20: Data Inquiry Screen

4.6.3 Output Inquiry

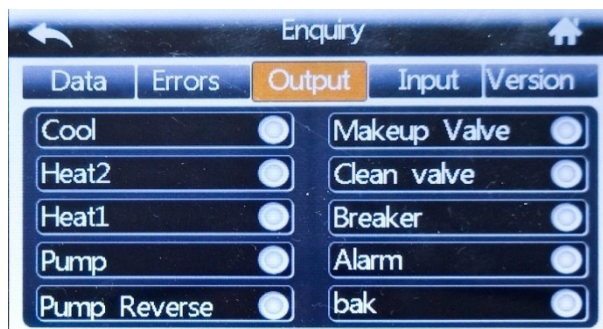

Picture 4-21: Output Inquiry Screen

When the indicator is gray, it means that corresponding relay has no output.

When the indicator light is green, it indicates that corresponding relay is outputting.

4.6.4 Input Inquiry

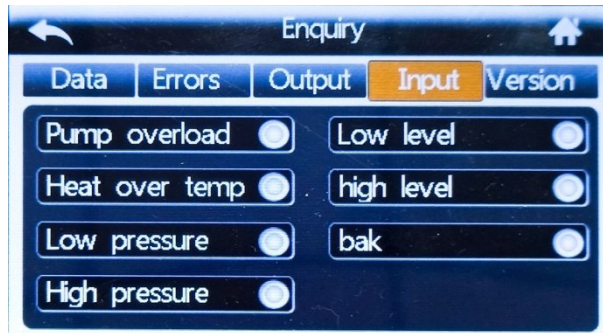

Picture 4-22: Input Inquiry Screen

When the indicator light is gray, it indicates that corresponding switch input is invalid.

When the indicator light is green, it indicates that corresponding switch input is valid.

4.6.5 Version Inquiry

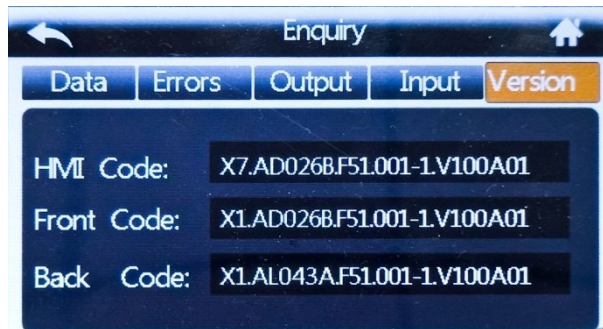

Picture 4-23: Version Inquiry Screen

Take real display value as standard.

4.7 Password Management

4.7.1 Login

Two groups of user names and passwords, as shown in the Table below:

Table 4-6: User and Password Function

User Name	Password (can be modified)	Function
User	123	Enter 【User Setting】 screen
Project	3588	Enter 【Project Setting】 【User Setting】 screen

4.7.2 Password Modification

In the "User Setting" screen, click < System Setting >, and then click < Modify User

Password >, it can modify the user password; In the "Project" screen, click < Password Mgmt. >, and then click < Modify Project Password >, it can modify the project's password; The modifying steps of the two groups of passwords are the same. Take "User" password modification as an example, as follows:

Enter "User Setting" screen, click < System Setting >, and then click < Modify User Password > to enter the screen below:

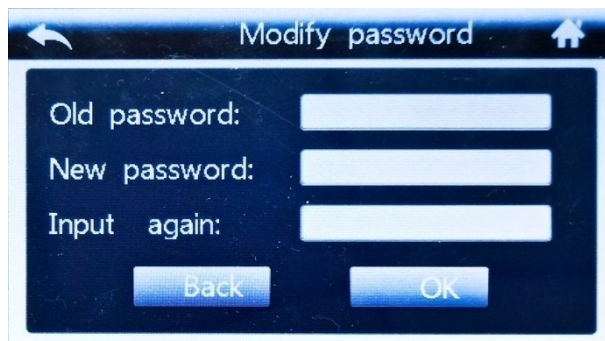

Picture 4-24: Modifying User Password Screen

- 1) Enter the old password. If the password is wrong, the password input box displays "Password Error". Press the input box to clear and re-enter the old password.
- 2) Input the new password;
- 3) Input the new password again;
- 4) Confirm

If the passwords of twice inputs are different, it will pop up the prompt box of "different passwords", it indicates the password modification is not success.

If the modified password is successful, it will pop up the prompt box of "Password Modified Successfully! Please be noted to save the new password! ".

4.8 Controller Exception List

No.	Fault Name	Detection Logic	Machine Action after Alarm	Reset Mode
1	3-phase power phase reverse /	1. When alarm occurs, the machine stops running. After troubleshooting, reset	Stop temp. control	Manual reset

	phase loss	<p>manually.</p> <p>2. When powered on, it starts detection, the phase reverse alarm delays 1.2m secs., and the phase shortage alarm delays 3 secs. If it needs to disable the on-board phase sequence detection, please set the project parameter [3-phase power detection] to "disabled".</p>		
2	Pump overload	<p>1. Power-on detection</p> <p>2. Pump overload input point is valid, and the alarm delays 2 secs. Stop and release.</p>	Stop temp. control	Manual reset
3	Heater overheat	<p>1. Power-on detection</p> <p>2. Alarm action:</p> <p>1) EGO input point is valid, the alarm delays 2 secs., and open the circuit breaker output point.</p> <p>2) $PV - \text{【SV】} > \text{【overheat release output temp.】}$, open the circuit breaker, it alarms EGO overheat. The temp. must reach the set temp. once that can be valid. Control without processing when the temperature is set from high to low.</p> <p>Note: It alarms when one of the conditions is met.</p>	Stop temp. control	Manual reset
4	Low pressure	<p>1. After system powered on, it starts to detect the inlet water pressure.</p> <p>2. Low pressure input point is valid, and the alarm delays 2 secs.</p>	Stop temp. control	Manual reset
5	Too high pressure	<p>1. When the high-pressure switch receives the high-pressure signal, the air exhaust valve will open according to the set time. If the [high pressure alarm time] is still in high pressure status, it will give the high pressurer alarm.</p> <p>2. Pressure sensor detection</p>	Stop temp. control	Auto Reset

		Use the pressure sensor, if the medium pressure is higher than the 【High pressure alarm】 during the operation, it delays 2 secs. and alarms for “ too high pressure”. Set the 【High pressure alarm】 to 0, disable this function.		
6	Low liquid level	<p>Press the start button to start detection</p> <p>Detection method:</p> <p>Start-up stage: If the liquid level is at low level after the refilling delay time (adjustable, range 0-300s, preset 90s), it will give low liquid level alarm, shut down and release.</p> <p>Temp. control stage: During the heating process, if the high water level signal fails, the refilling exceeds the 【water refilling alarm time】 , it will give the "low liquid level" alarm and shutdown.</p>	Maintenance status	Auto Reset
7	Low liquid level	<p>Press the start button to start detection</p> <p>Detection method:</p> <p>Start-up stage: If the liquid level is at low level after the refilling delay time (adjustable, range 0-300s, preset 90s), it will give low liquid level alarm, shut down and release.</p> <p>Temp. control stage: If it detects no signal input of the low liquid level, the alarm will delay 2 secs, and it will shut down and release.</p>	Stop temp. control	Manual reset
8	Abnormal control probe	Probe fault	Stop temp. control	Manual reset
9	Abnormal return medium probe	Probe fault	Stop temp. control	Manual reset
10	Abnormal mould probe	Probe fault	Stop temp. control	Manual reset
11	Pressure sensor	1. Check whether the sensor input signal is	Maintenance	Manual reset

	fault	normal. 2. AI 1 input is defined as "disabled", disable the fault.	status	
12	Flow sensor fault	1. Check whether the sensor input signal is normal. 2. AI2 input is defined as "disabled", disable the fault.	Maintenance status	Manual reset
13	Temp. differences between the return medium are too big.	1. When it gives alarm, the machine run normally. After trouble-shooting, it will reset automatically. 2. Detection during the unit running status: (1) When the Control temp. – return medium temp. > 【Return medium temp. deviation】 , and it delays the 【Temp. difference alarm delay】 seconds, the system will give alarm for large return medium temp. difference. When the 【Return medium temp.difference alarm】 = 0, disable this function. (2) It will process only after the temp. exceeds the set value and runs a temp. vibration cycle. After it modifies the [SV] or forced cooling, this trouble will not be solved.	Maintenance status	Auto reset
14	Temp. differences between the mould are too big.	1. When it gives alarm, the machine run normally. After trouble-shooting, it will reset automatically. 2. Detection during the unit running status:(1) When the Control temp. – mould temp. > 【Mould temp. deviation】 , and it delays the 【Temp. difference alarm delay】 seconds, the system will give alarm for large mould temp. difference. When the 【 Mould temp. difference】 = 0, disable this function. (2) It will process only after the temp. exceeds the set value and runs a temp. vibration cycle.	Maintenance status	Auto reset

		After it modifies the [SV] or forced cooling, this trouble will not be solved.		
15	Too low temp.	<p>【SV】 - PV > 【Low temp. deviation alarm】 , it delays 2 secs., and gives low temp. alarm.</p> <p>【SV】 - PV > 【Low temp. deviation alarm】 , it resets the fault automatically.</p> <p>When the 【Low temp. deviation alarm】 = 0, disable this function.</p> <p>Notes: The temp. must reach the set temp. once that can be valid. Control without processing when the temperature is set from high to low.</p>	Maintenance status	Manual reset
16	Too high temp.	<p>PV - 【SV】 > 【High temp. deviation alarm】 , it delays 2 secs., and gives high temp. alarm.</p> <p>PV - 【SV】 > 【High temp. deviation alarm】 , it resets the fault automatically.</p> <p>When the 【High temp. deviation alarm】 = 0, disable this function.</p> <p>Notes: The temp. must reach the set temp. once that can be valid. Control without processing when the temperature is set from high to low.</p>	Maintenance status	Manual reset
17	Too low flow	<p>1. Machine shutdown when it alarms. After the flow becomes normal, reset manually.</p> <p>2. Use flow sensor. When it running, the medium flow is lower than the 【 Low flow alarm】 , it delays 2 secs. and alarms “low flow”.</p> <p>When the 【Low flow alarm】 = 0, disable this fault.</p>	Stop temp. control	Manual reset
18	Too high pressure	<p>1. Machine shutdown when it alarms, and reset manually.</p> <p>2. Use flow sensor. When it running, the medium flow is lower than the 【High pressure</p>	Stop temp. control	Manual reset

		alarm】 , it delays 2 secs. and alarms “high pressure”. When the 【High pressure alarm】 = 0, disable this fault.		
19	Interference Alarm	1. In the temp. control stage, the temp. drops or rises beyond the [Interference alarm] temp. within 1s. 2. When the 【Interference alarm】 = 0, disable this fault.	Maintenance status	Manual reset
20	Heater alarm	1. In the temp. control stage, when the control temp. can't reach the set temp. of - 5 °C within the 【Heater alarm】 time, it alarms. When it reaches the set temp., it will dismiss the alarm automatically. 2. When the 【Heater alarm】 = 0, disable this fault.	Maintenance status	Auto reset
21	Unit needs maintenance	Power on detection: Once this fault occurs, the unit can't start. Enter the project parameter to set the [Unit maintenance time] to 0, and eliminate this fault.	Stop temp. control	Manual reset
22	Overtime when communicating with the rear plate	The comm. wire between the display panel and the control board breaks	Maintenance status	Auto reset
23	Rear plate data error	Parameter data verification error	Stop temp. control	Please contact the manufacturer.

5. Trouble-shooting

Failures	Possible reasons	Solutions
LCD displays nothing after switch on power and press ON/OFF POWER key.	Did not connect through power supply. Main switch broken. Power supply wires problems. Control circuit fuse melt. Transformer broken.	Connect through power supply. Replace main switch. Check electrical wires. Fix the fuse. Replace the transformer.
Phase alarm	Power supply low voltage. Phase shortage. Phase reversal. PCB problems.	Check power supply. Check power supply. Exchange two of the wires of power supply. Replace the PCB.
Pump overload	Abnormal fluctuations of power supply. Pump blocked. Pump motor problems. Error setting current of thermo relay (F1).	Check power supply. Check the pump. Check the pump motor. Correctly set the setting current of thermo relay (F1) 1.1 times as motor rated current. Please refer to Main Components for detailed description of thermo relay. Reset overload relay: Wait for one minute, and then press the blue button to reset.
EGO overheat	EGO temperature setting mistakes. EGO poor temperature detecting. Heater contactor K1 and K2 problems.	Correctly set the EGO temp. (EGO temp. setting value= temp. setting value+10℃). Replace the EGO. Replace the contactor.
Low liquid level.	Oil tank shortage. Poor liquid level switch.	Check the water tank and whether the pipeline has heat transfer oil leaked and refill it. Replace the level switch.
Insufficient pressure	Insufficient pressure of the external water supply. Poor pressure switch.	Increase the pressure of external water supply. Replace the pressure switch.
High pressure	The mold circulating water ball valve doesn't open or the pipe is blocked. Poor pressure switch.	Check the ball valve and pipeline. Replace the pressure switch.
Temp. window displays "----"	Abnormal sensor.	Check the sensor.
Once running, pump output indicator lightens but pump cannot start. After a	PCB output relay problems. Electrical circuit problems.	Check or replace the PCB. Check electrical circuit.

while pump still fails to run.		
Differences between setting temperature and actual temperature are too big.	Too short time after machine startup. Temperature parameter setting error. Cooling solenoid valve problems.	Wait for a while. Check temperature parameters. Please refer to the standard manual of setting parameters. Replace solenoid valve.
Temperature can't rise up.	Heater contactor problems. Heater problems. Thermocouple problems. PCB output point problems.	Replace the contactor. Replace pipe heater. Replace thermocouple. Check and repair PCB.
Circuit breaker tripping off at turning on main switch.	Short circuit of main circuit. Transformer short circuit or connected with earth wire. Problems of circuit breaker.	Check electrical wire. Replace circuit breaker.
Circuit breaker tripping off at turning on pump switch.	Pump motor coil short circuit. Problems of circuit breaker.	Check the pump motor. Replace the circuit breaker.
Circuit breaker tripping off after short heater output.	Heater tube short circuit or shell contact. Problems of circuit breaker.	Replace heater tube. Replace circuit breaker.
Three phase reverse phase / phase loss	Main power wire reversely connected,	Replace the two main power wires.
Heater overheat	Solid state relay break down, circuit board failure, electric, pipe heater broken.	Check whether the solid-state relay, circuit board and pipe heaters are damaged. Check whether the solenoid valve is blocked.
Low pressure	The water refilling pressure in the plant is insufficient, water inlet blocked, and the plunger pump may run abnormally.	Check whether the valve at the water refilling port is open. Check whether the system inflator run normally.
High pressure	The pipe may be blocked, and the circuit board may run abnormally.	Check whether the solenoid valve runs normally. Check whether the pressure release function of the circuit board works normally.
Low liquid level	Check whether the refilling pressure is sufficient.	Check the water refilling pressure is enough.
Abnormal control probe	Probe fault	Replace the probe.
Abnormal return media probe	Probe fault	Replace the probe.
Abnormal mould probe	Probe fault	Replace the probe.
Pressure sensor fault	Pressure sensor fault	Replace the sensor.

Differences between the return medium temp. is too big.	There maybe problems in the pipes between the water heater and mould.	Check the pipe.
Differences between the mould temp. is too big.	There maybe problems in the pipes between the water heater and mould.	Check the pipe.
Too low temp.	Solid state relay break down, circuit board failure, electric, pipe heater broken.	Check whether the solid-state relay and solenoid valve circuit board operate normally.
High temp.	Solid state relay break down, circuit board failure, electric, pipe heater broken.	Check whether the solid-state relay and solenoid valve circuit board operate normally.
Too low flow	The water heater pipes may block.	Check whether the water heater pipe has blocked. Check whether the water flow distributor pipeline is connected properly.
High pressure	The water heater pipes may block, and the solenoid valve may run abnormally.	Check whether the water heater pipe is blocked, and the solenoid valve runs normally.
Interference alarm	The water heater pipes may block, and the solenoid valve may run abnormally.	Check whether the water heater pipe is blocked, and and the solenoid valve runs normally.
Heater alarm	Solid state relay break down, circuit board failure, electric, pipe heater broken.	Check whether the circuit breaker trips. Check whether the solid state relay is broken. Check whether the solenoid valve is broken, so it keeps cooling all the time.
Unit needs maintenance.	When the setting time is up, it reminds to maintain the machine.	Detect after powering on, once it shuts down, the unit can't start. Enter the project parameter to set [Unit Maintenance Time] to 0 to shoot the trouble.
Over time when connecting the rear plate.	The comm. line between the display board and the control board is disconnected	Please contact the manufacturer.
Rear plate data error	Parameter data verification error	Please contact the manufacturer.

6. Maintenance and Repair

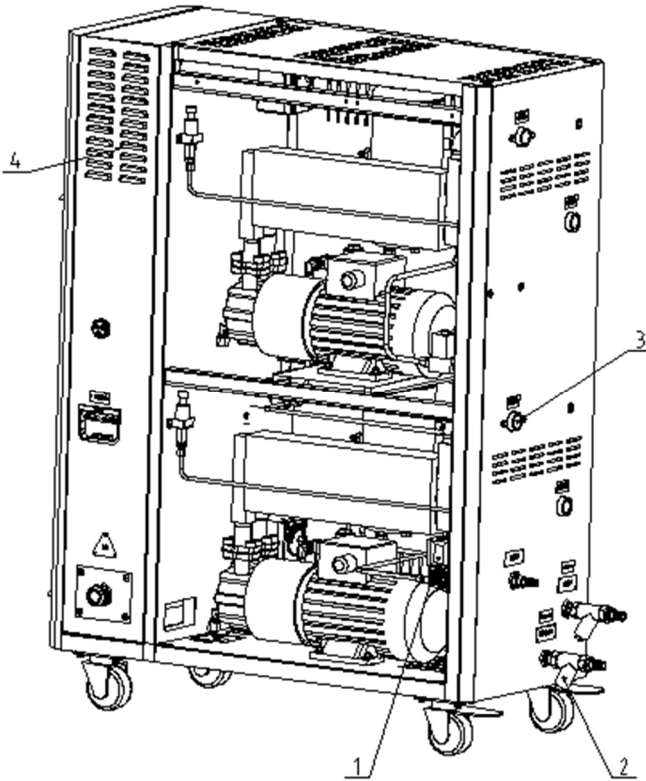

1. Clean the solenoid valve.
Cycle: Every three months.
2. Clean the Y-type filter valve.
Cycle: Every month.
3. Clean the pipe heater.
Cycle: Every six months.
4. Check the contactor.
Cycle: Every three months.

Pay attention to the following rules during maintenance:

- 1) It requires two personnel to check the machine. Firstly, reduce the temperature, cut off the power supply, and drain the oil and water; Make sure to operate after inspection with enough maintenance space.
- 2) When operating, it's dangerous to touch the machine as it is in high temperature state. The operator must stop the machine before checking and maintenance and wear safety gloves before operation.
- 3) In order to extend the life of the system and prevent accidents, periodic inspections must be carried out.
- 4) Please reduce the temperature to room temperature (below 50°C), cut off power supply and drain oil and water first while inspecting the machine;

Please note that it is dangerous to check or tear down the machine during operation.

6.1 Open the Covers

- 1) Remove the screws on the side plate, and then lift the side plate up to remove it.



Picture 6-1: Open the Covers 1

- 2) Remove the four screws on the cover plate and lift it up to remove it.



Picture 6-2: Open the Covers 2

- 3) Open the control box (Use the door lock key to open the door lock and then open the control box as shown in the below picture).

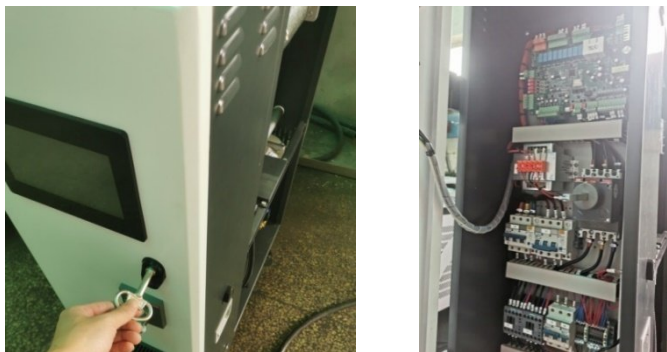

Picture 6-3: Open the Covers 3

6.2 Y Type Strainer

- 1) Clean soft water should be used as cooling water. Filter screen is used in the strainer to stop impurities and pollutants to enter into water pipe.
- 2) Impurities or pollutants may cause errors and bad temperature control. Clean filter screen of the strainer periodically.
- 3) Cleaning steps: turn off power and cooling water supply. Open the top cover of filter screen to clean the filter.

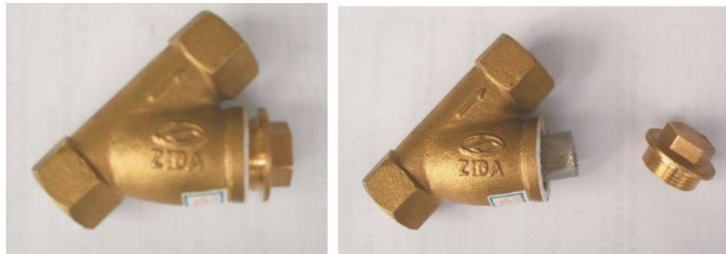

Picture 6-4: Y Type Strainer

6.3 Solenoid Valve

Replace solenoid valve:

- 1) Open machine top cover.
- 2) Take down right side cover.
- 3) Unfix the solenoid valve for replacement.
- 4) Install the covers in a reverse order.

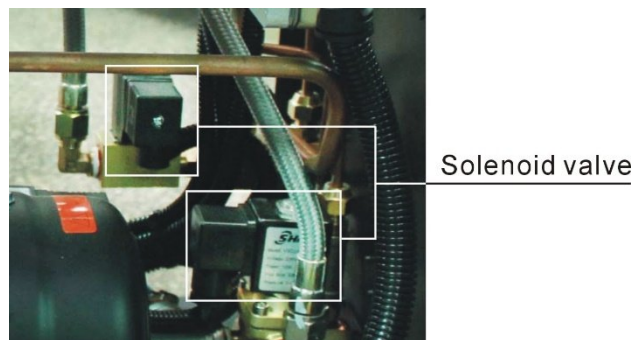

Picture 6-5: Solenoid Valve

6.4 Pipe Heater

The pipeline will be blocked when the pipe heater has been used for over six months or it is suffered low heating efficiency, and then it's suggested to clean the interval pipe heater. It can use our Tube Cleaning Machine STCM to clean the heating pipe, and our tube cleaning machine has standard industrial cleaning agent:

JP72821200100 industrial cleaning agent ZJ-821-25L/barrel. The cleaning time of common mould temperature controller: 1~2 hours (The cleaning time is not a fixed time, and can be set on demand). The cleaning steps are as follow:

- 1) Connect the machines to be cleaned as per their quantity with the mould inlets /outlets of the tube cleaning machine in series (as shown in the figure below);
- 2) Add a certain proportion of industrial cleaning agent into the refilling water of the water tank, and then convey some agent water into the mould pipeline through the power driven pump to complete the water cycle of repeated water suction and discharge; ,
- 3) Through the large flow washing and chemical reaction with the liquid agent, it can clean the hard saline alkali scale, rust and other substances in the mould pipeline as to unblock the pipeline, thus improving the energy efficiency.

After cleaning, the waste water in the water tank pipeline can be neutralized by the regulator: YP72180200100 PH regulator (alkaline) ZJ-180-25L / barrel (option).

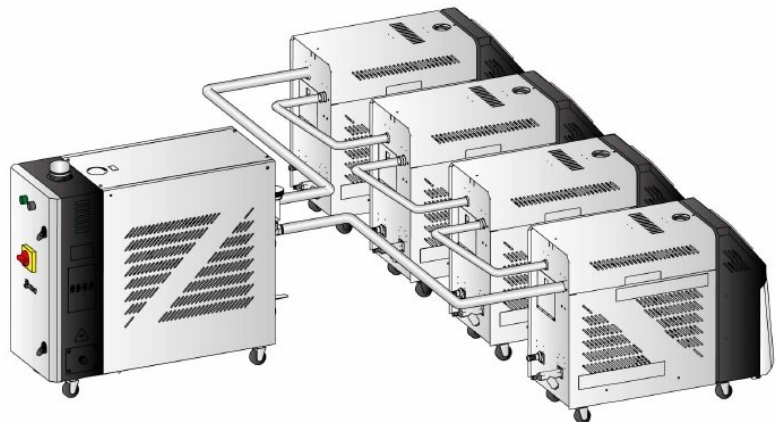

Picture 6-6: Pipe Heater Cleaning

6.5 Bypass Valve

Close the bypass valve when the pressure display is too low.



Picture 6-7: Bypass Ball Valve

6.6 Maintenance Schedule

6.6.1 About the Machine

Model _____ SN _____ Manufacture date _____

Voltage _____ Φ _____ V Frequency _____ Hz Power _____ kW

6.6.2 Installation & Inspection

- Check the installation space is enough as required.
- Check the pipes are correctly connected.

Electrical installation

- Voltage: _____ V _____ Hz
- Fuse melting current: 1 Phase _____ A 3 Phase _____ A
- Check phase sequence of power supply.

6.6.3 Daily Checking

- Check machine startup function.
- Check all the electrical wires.

6.6.4 Weekly Checking

- Check loose electrical connections.
- Check and clean Y type filter ¹.
- Check solenoid valve.
- Check motor overload and phase reversal alarm function.
- Check whether pipeline joints are under looseness.
- Check the sensitivity of EGO.

6.6.5 Trimonthly Checking

- Check level switch.

- Check the contactor ².
- Replace the hot kerosene with a using temperature above 160 degree ³.

6.6.6 Half-yearly Checking

- Check damaged pipes.
- Clean process heater/cooler.
- Check indicator and buzzer.
- Replace the hot kerosene with a using temperature above 120~160 degree ⁴.

6.6.7 Yearly Checking

- Replace the hot kerosene with a using temperature above 120 degree ⁵.

6.6.8 3 year Checking

- PC board renewal.
- No fuse breaker renewal.

Note: 1. Y-type filter has the function of filling water cooling protection effect, be sure the waterway are clear to avoid cooling failure.

2. Manufacturer laboratory data for AC contactor is two million times in life. we suggest service life for one million four hundred thousand times, if work eight hours per day, recommended replacing frequency is 1.5 years, if work day and night, replacement is suggested to be done every six months.
3. Hot kerosene coke will influence the detection accuracy of internal temperature probe and the efficiency of heat elements, three months replacing frequency is suggested.
4. Hot kerosene coke will influence the detection accuracy of internal temperature probe and the efficiency of heat elements, six months replacing frequency is suggested.
5. Hot kerosene coke will influence the detection accuracy of internal temperature probe and the efficiency of heat elements, and suggested replacing frequency is one year.

Appendix 1:

SHINI Comm.Variable Table (1)

STM Comm. Variables					Comm. Protocol: MODBUS-RTU
D-Map(400 01+i)	English	Chinese	Range	Description	Type
1	CONTROL PV	Control temp.	-50 ~ 500	※1(Different displays depending on whether the temp. unit ° C has a decimal point.)	read only
2	RET PV	Return water temp.	-50 ~ 500		read only
3	ENT PV	Output water temp.	-50 ~ 500		read only
4	SV	Control target value	-50 ~ 500		read only
5	RTC YEAR	Current year	0 ~ 99	2000(0), 2001(1), ..., 2099(99)	read only
6	RTC MONTH	Current month	1 ~ 12		read only
7	RTC DATE	Current date	1 ~ 31		read only
8	RTC DAY	Current week	0 ~ 6	Sun.(0), Mon. (1), Tues.(2), ..., Sat.(6)	read only
9	RTC HOUR	Current hour	0 ~ 23		read only
10	RTC MINUTE	Current minute	0 ~ 59		read only
11	RTC SECOND	Current secs.	0 ~ 59		read only
12	CONTROL STATUS	Control status	0 ~ 3	Fault(0), stop control(1), In controlling(2), Auto-tuning(3)	read only

13	MMI STATUS	Running status	0 ~ 255	※2 (Operate it with bit address)(as shown in Appendix2)	read only
14	DO STATUS	Contact output status	0 ~ 255	※2 (Operate it with bit address)(as shown in Appendix2)	read only
15	DI STATU	Contact input status	0 ~ 255	※2 (Operate it with bit address)(as shown in Appendix2)	read only
16	ALARM STATUS	Alarm status	0 ~ 255	※2 (Operate it with bit address)(as shown in Appendix2)	read only
17	CONTROL PV ERROR	Control temp. input alarm	0 ~ 255	※2 (Operate it with bit address)(as shown in Appendix2)	read only
18	RET PV ERROR	Return water temp. input alarm	0 ~ 255	※2 (Operate it with bit address)(as shown in Appendix2)	read only
19	ENT PV ERROR	Water outlet temp. input alarm	0 ~ 255	※2 (Operate it with bit address)(as shown in Appendix2)	read only
20	REMOTE ERROR	Remote control input alarm	0 ~ 255	※2 (Operate it with bit address)(as shown in Appendix2)	read only
21	KEY STATUS	KEY key status	0 ~ 255	※2 (Operate it with bit address)(as shown in Appendix2)	read only
22	LED STATUS	LED indicator status	0 ~ 255	※2 (Operate it with bit address)(as shown in Appendix2)	read only
100	HOUT	Heating end output	0 ~ 100%		read only
101	COUT	Cooling end output	0 ~ 100%		read only

102		Backlight time	0 ~ 255	0 ~255	read /write
104	RUN/RESET KEY	RUN/RESET KEY	0, 1	1 = Key (button) operation. After this operation, it will be automatically reset to 0.	write only
105	AUTO-TUNING KEY	AUTO-TUNING KEY	0, 1		write only
106	AUTO-START KEY	AUTO-START KEY	0, 1		write only
107	SUCTION KEY	SUCTION KEY	0, 1		write only
108	COOLING KEY	COOLING KEY	0, 1		write only
109	BUZZER OFF KEY	BUZZER OFF KEY	0, 1		write only
110	SUCTION OFF KEY	SUCTION OFF KEY	0, 1		write only
112		Reset	1		write only
120		Flow value		Unit: 0.1L/min	read only
125		Pressure value		Unit:0.1bar	read only
150		Emptying temp.	0-120.0℃	When the PV temp. is less than [Emptying temp.], the reverse emptying can be started.	read /write
151		Emptying time	60 secs.	0-600 secs.	read /write
200	SV	Control target value (℃)	-50 ~ 500℃	※1(Different displays depending on whether the temp. unit °C has a decimal point.)	read /write

201	PB	Heating control belt	0 ~ 550°C	※1(Different displays depending on whether the temp. unit ° C has a decimal point.)	read /write
202	TI	Integral time	1 ~ 3600s		read /write
203	TD	Differential time	1 ~ 3600s		read /write
204	PBC	Cooling control zone	0 ~ 550°C	※1(Different displays depending on whether the temp. unit ° C has a decimal point.)	read /write
205	CT	Heating control cycle	1 ~ 100s		read /write
206	CTC	Cooling control cycle	1 ~ 100s		read /write
300	PHASE ALARM	Phase detection	0, 1	Unuse (0), use(1)	read /write
301	DEV1 ALARM	Output water temp. deviation	0 ~ 550°C	※1(Different displays depending on whether the temp. unit ° C has a decimal point.)	read /write
302	DEV2 ALARM	Return water temp. deviation	0 ~ 550°C		read /write
303	TURB ALARM	Interference alarm	0 ~ 550°C		read /write
304	HEATER ALARM	Heater alarm	0 ~ 3600s		read /write
401	SUB HEATING	Auxiliary output	0 ~ 550°C	※1(Different displays depending on whether the temp. unit ° C has a decimal point.)	read /write
402	COOLING TEMP	Cooling temp.	-50 ~ 500°C		read /write

500	H.LIMIT TEMP	Upper limit temp.	-50 ~ 500°C	※1(Different displays depending on whether the temp. unit ° C has a decimal point.)	read /write
501	L.LIMIT TEMP	Lower limit temp.	-50 ~ 500°C		read /write
502	TEMP UNIT	Temp. unit	0, 1	°C(0), °F(1)	read /write
503	TEMP DEGREE	Decimal point	0, 1	0.1(0), 1(1)	read /write
504	CTL TEMP BIAS	Control temp. correction	-550 ~ 550°C	※1(Different displays depending on whether the temp. unit ° C has a decimal point.)	read /write
505	RET TEMP BIAS	Return water temp. correction	-550 ~ 550°C		read /write
506	ENT TEMP BIAS	Output water temp. correction	-550 ~ 550°C		read /write
600	NOW YEAR	Year setting	0 ~ 99	2000(0), 2001(1), ..., 2099(99)	read /write
601	NOW MONTH	Month setting	1 ~ 12		read /write
602	NOW DATE	Date setting	1 ~ 31		read /write
603	NOW DAY	Week setting	0 ~ 6	Sun.(0), Mon. (1), Tues.(2), ..., Sat.(6)	read /write
604	NOW HOUR	Hour setting	0 ~ 23		read /write
605	NOW MINUTE	Minute setting	0 ~ 59		read /write
606	SCHDULE DAY	Week reserve setting	0 ~ 127	Sun.(0), Mon. (1), Tues.(2), ..., Sat.(6)	read /write

607	AUTO-START HOUR	Reserve auto start hr. setting	0 ~ 24	Unuse (00:00)	read /write
608	AUTO-START MINUTE	Reserve auto start min. setting	0 ~ 59		read /write
609	AUTO-END HOUR	Reserve auto shutdown hr. setting	0 ~ 24	Unuse (00:00)	read /write
610	AUTO-END MINUTE	Reserve auto shutdown min. setting	0 ~ 59		read /write
611	AS SETTING TIME	Check time setting	0 ~ 9999	Unuse (00:00)	read /write
612	RUNNING TIME	Device using time	0 ~ 9999		read only
700	LANGUAGE	Language setting	0, 1	Chinese(0), English(1)	read /write
702	PASSWORD	Password setting	0 ~ 9999		read /write
703	RET/ENT DISP	Return water output temp.	0, 1	Unuse (0), use(1)	read /write
704	W-FILL TM T1	Water refilling time T1	0 ~ 600s		read /write
705	W-FILL TM T2	Water refilling time T2	0 ~ 60s		read /write
706	RET/ENT DISP	Return loop display settings	0, 1, 2, 3	Display control loop, control+ return medium, control + mould, control+ return medium + mould	read /write

SHINI Comm.Variable Table (2)

STM Comm. Variables					Comm. Protocol: MODBUS-RTU
D- Map(400 01+i.J)	Name	BIT			
		0	1	2	3
		4	5	6	7
13	MMI STATUS	Control	Cooling	Auto-tuning	Suction
		Reserve	Buzzer Off	--	Input power
14	DO STATUS	Pump forward action	Pump forward action	Water refilling	Suction
		Alarm	Breaker	Air	--
15	DI STATUS	Pump overload	EGO	Low pressure	High pressure
		Low liquid evel	High liquid evel	--	Start control
16	ALARM STATUS	Phase alarm	Temp. alarm	Deviation alarm	Interference alarm
		Heating alarm	--	--	--
17	CONTROL PV ERROR	--	-Over	+Over	Sensor Open
		AD Error-	--	--	--
18	RET PV ERROR	--	-Over	+Over	Sensor Open
		AD Error-	--	--	--
19	ENT PV ERROR	--	-Over	+Over	Sensor Open
		AD Error-	--	--	--
20	REMOTE ERROR	--	-Over	+Over	Input Open
		AD Error-	--	--	--
21	KEY STATUS	RUN	AUTO-TUNING	AUTO-START	SUCTION OFF
		COOLING	SUCTION	BUZZER OFF	Power
D- Map(400 01+i.J)	Name	BIT			
		0	1	2	3
		4	5	6	7
22	STATUS 1	RUN	AUTO-TUNING	SUCTION	COOLING

		BUZZER OFF	AUTO-START	SUCTION OFF	F
	STATUS 2	POWER	HEATER OUTPUT	AUXILIARY HEATING OUTPUT	COOLING OUTPUT
		PUMP FORWARD ACTION	PUMP REVERSE ACTION	WATER REFILLING	ALARM

MODBUS -RTU uses the RS485serial port.

Note: The address minimum value is 1. If it readis and writies from zero, an error will occur.