

整机版本 Ver.C

1	2	3	4	5	6	7	8
A		B		C		D	
制图	版号	标题	图号	比例		第 1 张	
设计	核 准	SDL-40U	SDL-40U- CE-400V-F-1	标准	CE	共 5 张	
校对	日期	主电路图		机器电压		400V	
审核	日期	20170830		机器频率		50Hz	
更改前	更改后	更改人	日期	SHINI		信易电热机械股份有限公司 Shini Plastics Technologies, Inc.	
1	2	3	4	5	6	7	8

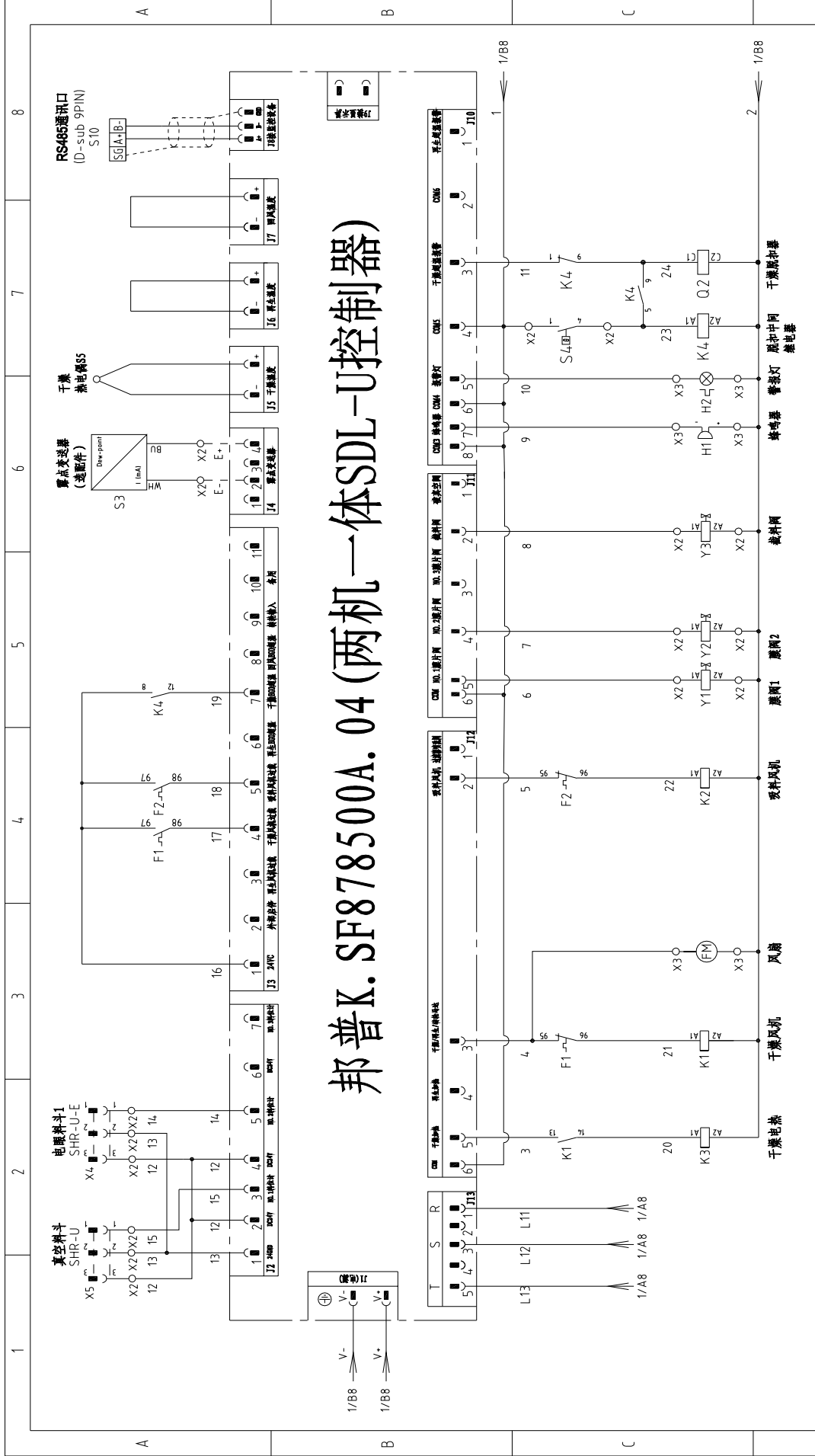

邦普K. SF878500A. 04 (两机一体SDL-U控制器)

整机版本 Ver.C

1	2	3	4	5	6	7	8
制图	设计	校对	审核	日期	更改人	日期	更改后
版号	核准	日期	20170830	2	3	4	5
标题	SDL-40U	控制电路图	图号	SDL-40U-CE-400V-F-2	比例	第 2 张	共 5 张
标准	CE	机器电压	400V	机器频率	50Hz		
标记	更改前	更改后	更改人	日期	更改后	更改前	更改后

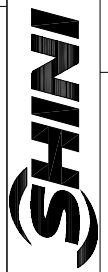

信易电热机械股份有限公司
Shini Plastics Technologies, Inc.

1 2 3 4 5 6 7 8

A B C D

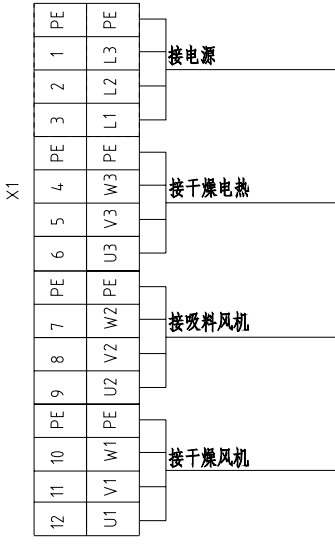
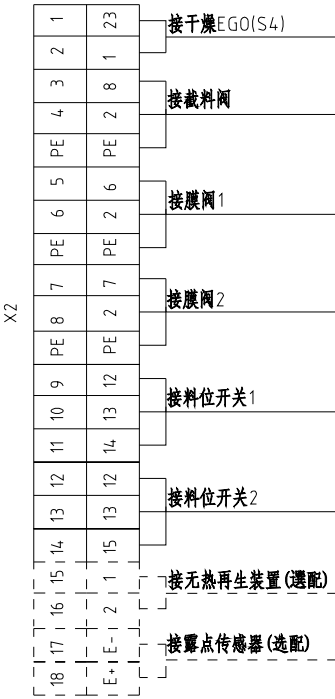
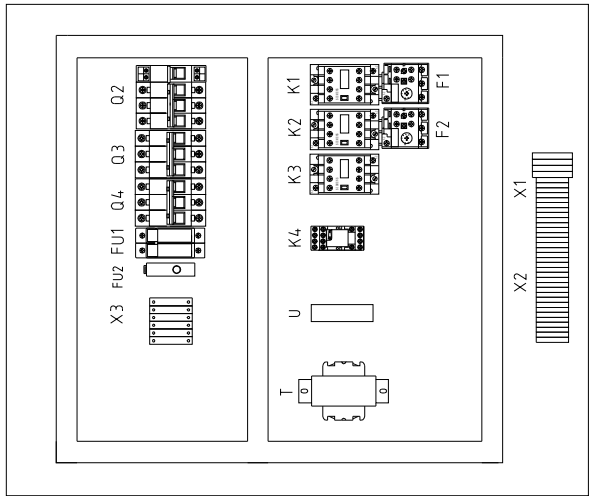

整机版本 Ver.C

图号	SDL-4.0U-CE-4.00V-F-3	比例	第 3 张
标题	电气元件布置图	标准	共 5 张
版号	核 准	机器电压	400V
制图	设计	机器频率	50Hz
日期	20170830		



1 2 3 4 5 6 7 8

1		2		3		4		5		6		7		8	
序号/NO	符号/Symbol	名称/Name	制造商/Manufacturer	型号/Type	规格/Specification	数量/Number	物料编号/Material number	备注/Remark							
1	Q1	主电源开关/Main switch	EATON	T0-2-1/EA/SVB	16A	1	YE10021160000								
2	Q2	断路器/Circuit-breaker	TECO	BM-63C/3006S	6A	1	YE40300603000								
3		励磁抽器/Excitation release	TECO	MX	230V 50/60Hz	1	YE40023560000								
4	Q3	断路器/Circuit-breaker	TECO	BM-63C/3006S	6A	1	YE40300603000								
5	Q4	断路器/Circuit-breaker	TECO	BM-63C/3010S	10A	1	YE40301003000								
6	K1	交流接触器/Contactor	SIEMENS	3RT6015-1ANZ1	7A 220V 50/60Hz	1	YE00601521000								
7	K2	交流接触器/Contactor	SIEMENS	3RT6016-1ANZ1	9A 220V 50/60Hz	1	YE00601621000								
8	K3	交流接触器/Contactor	SIEMENS	3RT6016-1ANZ1	9A 220V 50/60Hz	1	YE00601621000								
9	K4	中间继电器/Middle relay	WEIDMULLER	DRM270730LT	230V 50/60Hz	1	YE03270700000								
10	U	直流电源/Dc power	MEAN WELL	NES-35-24	OUT=DC24V 15A	1	YE71352400100								
11	T	变压器/Transformer	BAIYUN	BY-0407009	IN=400V OUT=230V 500mA	1	YE70402300800								
12	F1	热过载继电器/Overload relay	SIEMENS	3RU6116-0FB0	0.35-0.5A	1	YE01161350000								
13	F2	热过载继电器/Overload relay	SIEMENS	3RU6116-1EB0	2.8-4A	1	YE01160280000								
14	FU1	熔断器座 /Fuse base	CHNT	RT28-32	2P	1	YE41032200000								
15		熔断器芯 /Fuse core	CHNT	10x38 500V	2A	2	YE46002000000								
16	FU2	熔断器/Fuse	YINDA	FS-10	2A	1	YE41001000000								
17	S3	露点变送器/Dew-point transducer	CS	CS 217-0EM	POWER=24VDC OUT=4-20mA	1	-----	(1)(2)							
18	S4	温度保护器/Temperature protector	EGO	--	115-320°	1	-----	(1)							
19	S5	热电偶/Thermocouple	SHINI	ST-K	K	1	-----	(1)							
20	PCB	两机一体SDI-U控制器	PUMP	K.SF878500A.04	-----	1	YE80878500300								
21	H1	蜂鸣器/Buzzer	HITPOINT	PK-35A	220V AC/DC	1	YE84003500200								
22	H2	警报指示灯/Alarm indicator	SHINI	LED-3051	230VAC 50Hz	1	YE83305100200	(1)							
23	FM	风扇/Fan	SUNON	DP-200A	230VAC 40W	1	-----	(1)							
24	Y1,Y2,Y3	电磁阀/Solenoid valve	FESTO	MSFW-230-50/60	230VAC 50/60Hz	3	-----	(1)							
25	M1	风机/Blower	SHINI	----	400V 50/60Hz 0.12KW	1	-----	(1)							
整机版本 Ver.C															
注: (1) 表示非电控箱内材料; (2) 表示选配露点计;															
		制图		版号		F		标题		图号		比例		第 4 张	
		设计		核		准		SDI-40U		SDI-40U-CE-400V-F-4		标准		共 5 张	
		校对		日期		20170830		电气元件明细表一		CE		机器电压		400V	
标记		更改前		更改后		更改人		日期		审核		机器频率		50Hz	
1	2	3	4	5	6	7	8	SHINI 信易电热机械股份有限公司 Shini Plastics Technologies, Inc.							

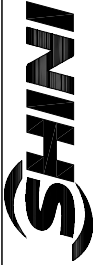
1		2		3		4		5		6		7		8	
序号/NO	符号/Symbol	名称/Name	制造商/Manufacturer	型号/Type	规格/Specification	数量/Number	物料编号/Material number	备注/Remark							
26	M2	风机/Blower	SHINI	----	400V 50/60Hz 1.5KW	1	----	(1)							
27	EH1	电热器/Heater	SHINI	----	400V 50/60Hz 3.0KW	1	----	(1)							
A		端子排/Terminal board	----	4mm ²	----	9	YE600004.03200								
29			----	4mm ² PE	----	3	YE600004.03500								
30			----	2.5mm ²	----	3	YE600025.03200								
31			----	2.5mm ² PE	----	1	YE600025.03400								
32	X2	端子排/Terminal board	----	2.5mm ²	----	14	YE600025.03200								
33			----	2.5mm ² PE	----	3	YE600025.03400								
34			----	2.5mm ²	----	2	YE600025.03200	(2)							
35			----	2.5mm ²	----	2	YE600025.03200	(3)							
B		端子排/Terminal	----	2.5mm ²	----	6	YE600025.03200								
37	X4 X5	重载接头/Heavy duty connector	SIBAS	HDC-HA-004.1	4P 10A	2	YE6804.1000100	(1)							
38	S10	通信接口板IS-485 (德Dsub-9pin接頭)	--	--	--	1	YE9004.8501200	(1)							
39		外觀IS485 (SAL-700G-A-19) 0版	--	--	--	1	YR4.004.8500000	(1)							
40		终端固定件/IS系列 (霍尼韦尔)	--	--	--	5	YE60000003900								
C															
D															
整机版本 Ver.C		注: (1)表示非电控箱内材料; (2)表示选配露点计; (3)表示选配无热再生装置。		标题		图号		比例		第 5 张					
		制图	版号	F	SDL-4.0U	SDL-4.0U-CE-4.00V-F-5		标准	CE	共 5 张					
		设计	核 准		电气元件明细表二			标准	CE						
		校对	日期	20170830		信易電熱機械股份有限公司 Shini Plastics Technologies, Inc.		机器电压	400V						
标记	更改前	更改后	更改人	日期	审核			机器频率	50Hz						
1	2	3	4	5	6	7	8								

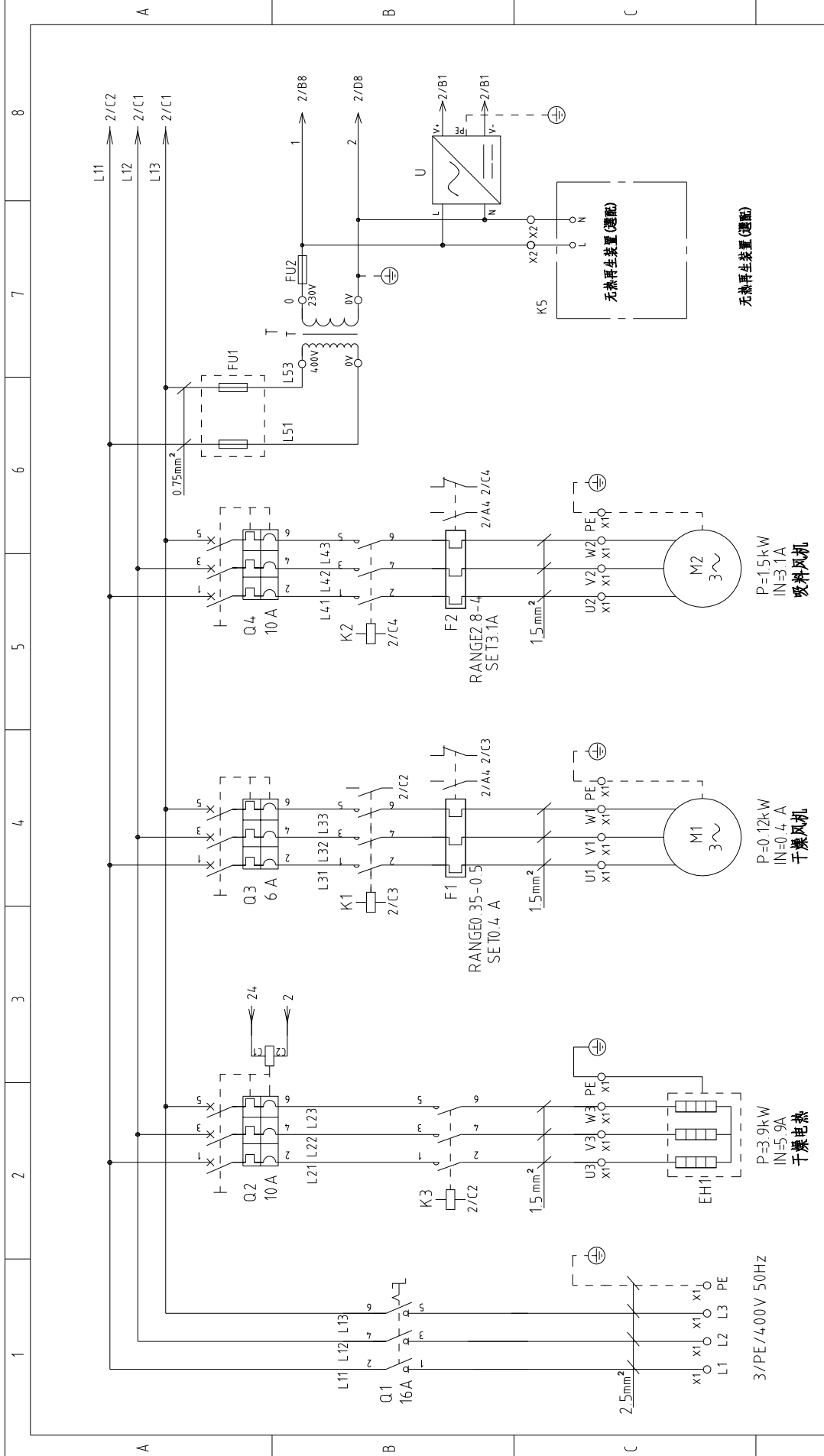

整机版本 Ver.C

无热再生装置(选配)

P=15kW
IN=3.1A
吹料风机

P=0.12kW
IN=0.4A
干燥风机

P=3.9kW
IN=5.9A
干燥电热

D	制图	F	标题	图号	比例	张数
	设计	核 准	SDL-80U/120U 主电路图	SDL-80U/120U- CE-400V-F-1	标准 CE	第 1 张
D	校对	日期	SHINI 信易电热机械股份有限公司 Shini Plastics Technologies, Inc.			
	审核	日期	机器电压 400V			
1	更改前	更改后	更改人	更改日期	机器频率 50Hz	
2	更改后	更改后	更改人	更改日期	共 5 张	
3	更改后	更改后	更改人	更改日期	400V	
4	更改后	更改后	更改人	更改日期	50Hz	
5	更改后	更改后	更改人	更改日期	共 5 张	
6	更改后	更改后	更改人	更改日期	400V	
7	更改后	更改后	更改人	更改日期	50Hz	
8	更改后	更改后	更改人	更改日期	共 5 张	

1 2 3 4 5 6 7 8

A B C D

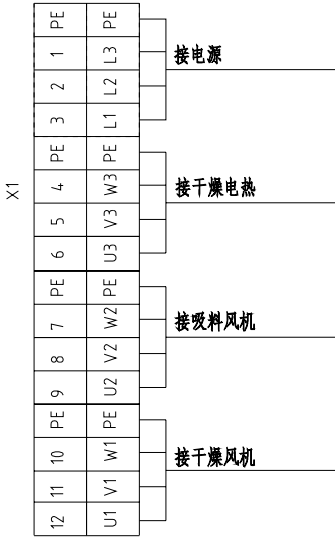
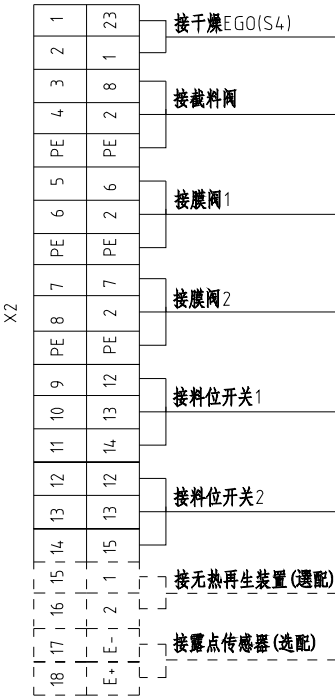
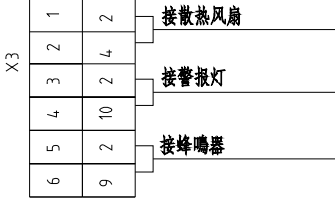
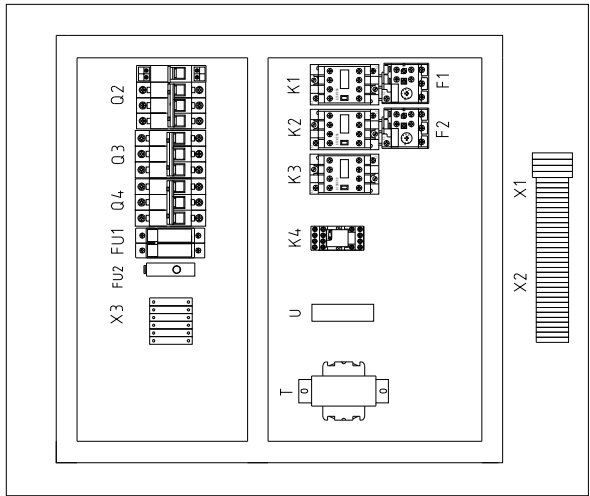

整机版本 Ver.C

图号	SDL-80U/120U-CE-400V-F-3	比例	第 3 张
标题	SDL-80U/120U 电气元件布置图	标准	共 5 张
版号	F	机器电压	400V
制图	设计	机器频率	50Hz
日期	20170830		
更改后	更改人		
更改前			



1 2 3 4 5 6 7 8

1		2		3		4		5		6		7		8		
序号/NO	符号/Symbol	名称/Name	制造商/Manufacturer	型号/Type	规格/Specification	数量/Number	物料编号/Material number	备注/Remark								
1	Q1	主电源开关/Main switch	EATON	T0-2-1/EA/SVB	16A	1	YE10021160000									
2	Q2	断路器/Circuit-breaker	TECO	BM-63C/3010S	10A	1	YE40301003000									
3		励磁抽器/Excitation release	TECO	MX	230V 50/60Hz	1	YE40023560000									
4	Q3	断路器/Circuit-breaker	TECO	BM-63C/3006S	6A	1	YE40300603000									
5	Q4	断路器/Circuit-breaker	TECO	BM-63C/3010S	10A	1	YE40301003000									
6	K1	交流接触器/Contactor	SIEMENS	3RT6015-1ANZ1	7A 220V 50/60Hz	1	YE00601521000									
7	K2	交流接触器/Contactor	SIEMENS	3RT6016-1ANZ1	9A 220V 50/60Hz	1	YE00601621000									
8	K3	交流接触器/Contactor	SIEMENS	3RT6016-1ANZ1	9A 220V 50/60Hz	1	YE00601621000									
9	K4	中间继电器/Middle relay	WEIDMULLER	DRM270730LT	230V 50/60Hz	1	YE03270700000									
10	U	直流电源/DC power	MEAN WELL	NES-35-24	OUT=DC24V 15A	1	YE71352400100									
11	T	变压器/Transformer	BAIYUN	BY-04.07009	IN=400V OUT=230V 500mA	1	YE70402300800									
12	F1	热过载继电器/Overload relay	SIEMENS	3RU6116-0FB0	0.35-0.5A	1	YE01161350000									
13	F2	热过载继电器/Overload relay	SIEMENS	3RU6116-1EB0	2.8-4A	1	YE01160280000									
14	FU1	熔断器座 /Fuse base	CHNT	RT28-32	2P	1	YE41032200000									
15		熔断器芯 /Fuse core	CHNT	10x38 500V	2A	2	YE46002000000									
16	FU2	熔断器/Fuse	YINDA	FS-10	2A	1	YE41001000000									
17	S3	露点变送器/Dew-point transducer	CS	CS 217-0EM	POWER=24VDC OUT=4-20mA	1	-----	(1)(2)								
18	S4	温度保护器/Temperature protector	EGO	--	115-320°	1	-----	(1)								
19	S5	热电偶/Thermocouple	SHINI	ST-K	K	1	-----	(1)								
20	PCB	两机一体SDU-1控制板	PUMP	K.SF878500A.04	-----	1	YE80878500300									
21	H1	蜂鸣器/Buzzer	HITPOINT	PK-35A	220V AC/DC	1	YE84003500200									
22	H2	警报指示灯/Alarm indicator	SHINI	LED-3051	230VAC 50Hz	1	YE83305100200	(1)								
23	FM	风扇/Fan	SUNON	DP-200A	230VAC 40W	1	-----	(1)								
24	Y1,Y2,Y3	电磁阀/Solenoid valve	FESTO	MSFW-230-50/60	230VAC 50/60Hz	3	-----	(1)								
25	M1	风机/Blower	SHINI	----	400V 50/60Hz 0.12KW	1	-----	(1)								
整机版本 Ver.C 注: (1)表示非电控箱内材料; (2)表示选配露点计;																
			制图	版号	F	标题		图号		比例		第 4 张		8		
			设计	核		SDL-80U/120U		SDL-80U/120U-CE-4.00V-F-4		标准		共 5 张				
			校对	准		电气元件明细表一		CE-4.00V-F-4		机器电压		400V				
标记			更改前	更改后	更改人	日期	审核	日期	20170830	机器频率		50Hz				
1			2		3		4		5		6		7		8	



信易电热机械股份有限公司
Shini Plastics Technologies, Inc.

1		2		3		4		5		6		7		8	
序号/NO	符号/Symbol	名称/Name	制造商/Manufacturer	型号/Type	规格/Specification	数量/Number	物料编号/Material number	比例	备注/Remark						
26	M2	风机/Blower	SHINI	----	400V 50/60Hz 1.5KW	1	----		(1)						
27	EH1	电热管/Heater	SHINI	----	400V 50/60Hz 3.9KW	1	----		(1)						
28	X1	端子排/Terminal board	----	4mm ²	----	9	YE600004.03200			A					
29			----	4mm ² PE	----	3	YE600004.03500								
30			----	2.5mm ²	----	3	YE60002503200								
31			----	2.5mm ² PE	----	1	YE60002503400								
32	X2	端子排/Terminal board	----	2.5mm ²	----	14	YE60002503200								
33			----	2.5mm ² PE	----	3	YE60002503400								
34			----	2.5mm ²	----	2	YE60002503200		(2)						
35			----	2.5mm ²	----	2	YE60002503200		(3)						
36	X3	端子排/Terminal	----	2.5mm ²	----	6	YE60002503200			B					
37	X4, X5	重载插头/Heavy duty connector	SIBAS	HDC-HA-004.1	4P 10A	2	YE6804.1000100		(1)						
38	S10	通信接口板IS-485 (2D)sub-9pin接脚	--	--	--	1	YE9004.8501200		(1)						
39		外殼IS485 (SKL-700G-A-19) 0版	--	--	--	1	YR4.004.8500000		(1)						
40		終端固定件B/GX系列 (霍尼韦尔)	--	--	--	5	YE60000003900								
C															
D															
整机版本 Ver.C										注: (1)表示非电控箱内材料; (2)表示选配露点计;					
		制图		版号		F		标题		图号		比例		第 5 张	
		设计		核 准				SDL-80U/120U- 电气元件明细表二		SDL-80U/120U- CE-400V-F-5		标准		共 5 张	
		校对		日期		20170830		SHINI 信易电热机械股份有限公司 Shini Plastics Technologies, Inc.		机器电压		CE		400V	
标记		更改后		更改人		日期		审核		机器频率		50Hz		8	

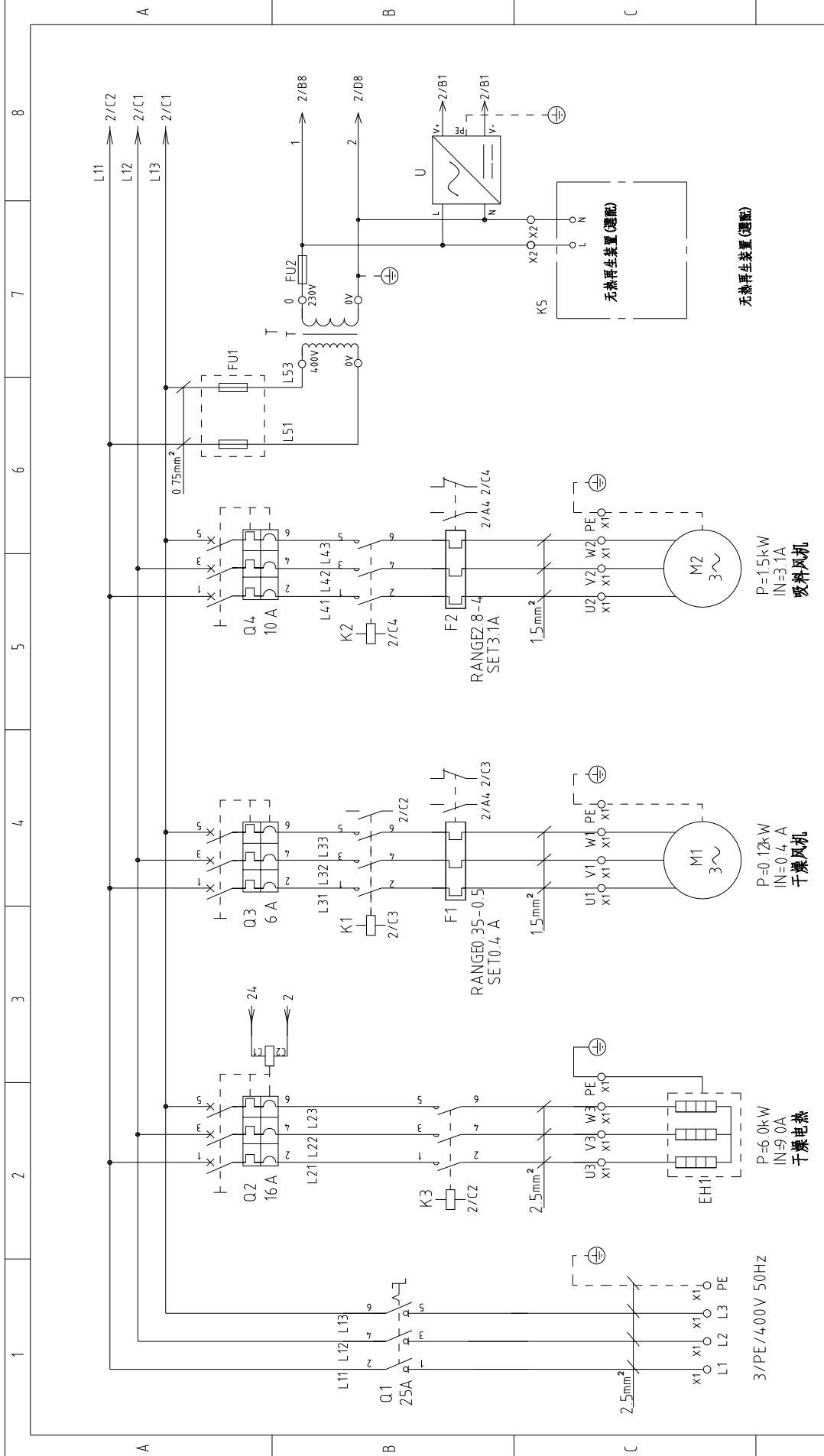

整机版本 Ver.D

1	2	3	4	5	6	7	8
A		B		C		D	
比例	标准	CE	CE	CE	CE	CE	CE
机器电压	400V	机器频率	50Hz	第 1 张			
图号		SDI-160U-CE-400V-F-1		共 5 张			
标题		主电路图		SDI-160U			
制图		设计		F		20170830	
校对		审核		日期		20170830	
更改前		更改后		更改人		更改日期	
标记	更改前	更改后	更改人	更改日期	20170830		
SHINI		信易电热机械股份有限公司		Shini Plastics Technologies, Inc.		8	

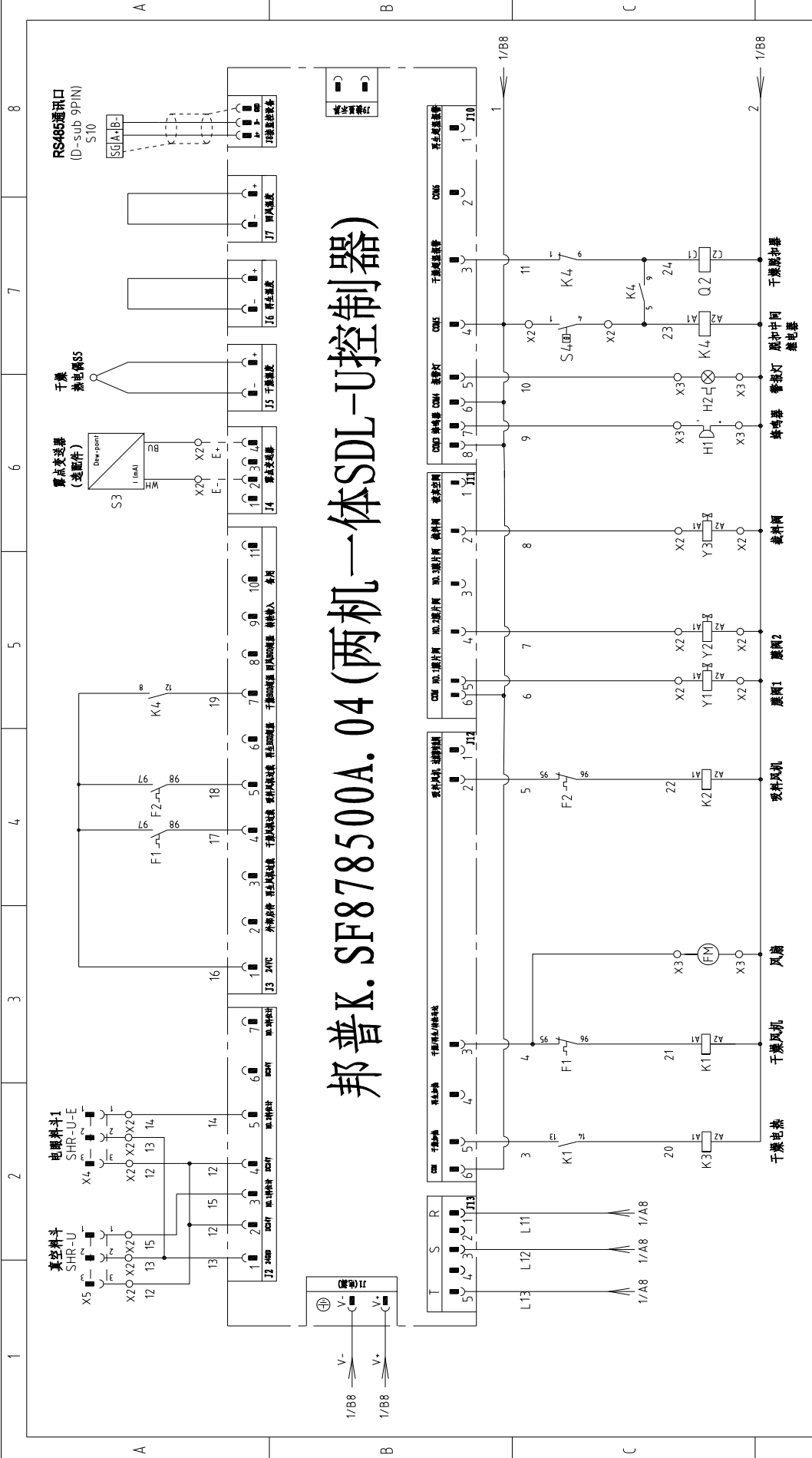

邦普K.SF878500A.04 (两机一体SDL-U控制器)

整机版本 Ver.D	制图	设计	校对	审核	日期	更改人	更改后	更改前	标记	1	2	3	4	5	6	7	8	比例	标准	CE	第 2 张	共 5 张	400V	50Hz			
																									图号	标题	版号
		控制电路图		SDL-160U		SDL-160U-CE-400V-F-2																					

1 2 3 4 5 6 7 8

A B C D

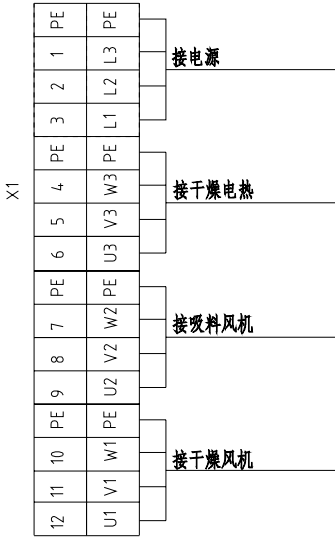
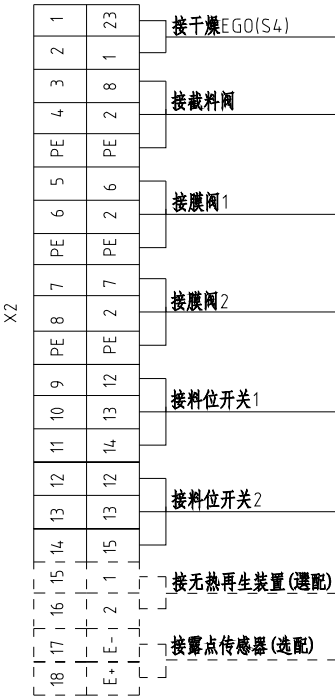
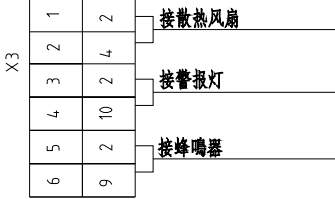
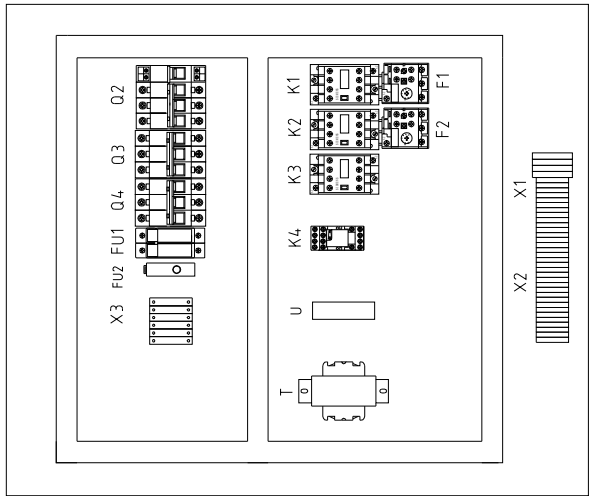

整机版本 Ver.D

图号	SDL-160U- 电气元件布置图	图号	SDL-160U- CE-400V-F-3	比例	第 3 张
标题	SDL-160U	标题	SDL-160U- CE-400V-F-3	标准	共 5 张
版号	F	版号	核 准	机器电压	400V
制图	设计	制图	校 对	机器频率	50Hz
日期	20170830	日期	更 改 人		
日期		日期	更 改 后		
日期		日期	更 改 前		

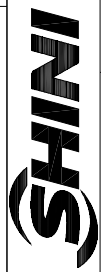

信易电热机械股份有限公司
Shini Plastics Technologies, Inc.

1 2 3 4 5 6 7 8

1		2		3		4		5		6		7		8	
序号/NO	符号/Symbol	名称/Name	制造商/Manufacturer	型号/Type	规格/Specification	数量/Number	物料编号/Material number	备注/Remark							
1	Q1	主电源开关/Main switch	EATON	P1-25/EA/SVB	25A	1	YE10125250000								
2	Q2	断路器/Circuit-breaker	TECO	BM-63C/3016S	16A	1	YE40301603000								
3		励磁释放器/Excitation release	TECO	MX	230V 50/60Hz	1	YE40023560000								
4	Q3	断路器/Circuit-breaker	TECO	BM-63C/3006S	6A	1	YE40300603000								
5	Q4	断路器/Circuit-breaker	TECO	BM-63C/3010S	10A	1	YE40301003000								
6	K1	交流接触器/Contactor	SIEMENS	3RT6015-1ANZ1	7A 220V 50/60Hz	1	YE00601521000								
7	K2	交流接触器/Contactor	SIEMENS	3RT6016-1ANZ1	9A 220V 50/60Hz	1	YE00601621000								
8	K3	交流接触器/Contactor	SIEMENS	3RT6018-1ANZ1	16A 220V 50/60Hz	1	YE00601800000								
9	K4	中间继电器/Middle relay	WEIDMULLER	DRM270730LT	230V 50/60Hz	1	YE03270700000								
10	U	直流电源/DC power	MEAN WELL	NES-35-24	OUT=DC24V 15A	1	YE71352400100								
11	T	变压器/Transformer	BAIYUN	BY-0407009	IN=400V OUT=230V 500mA	1	YE70402300800								
12	F1	热过载继电器/Overload relay	SIEMENS	3RU6116-0FB0	0.35-0.5A	1	YE01161350000								
13	F2	热过载继电器/Overload relay	SIEMENS	3RU6116-1EB0	2.8-4A	1	YE01160280000								
14	FU1	熔断器座/Fuse base	CHNT	RT28-32	2P	1	YE41032200000								
15		熔断器芯/Fuse core	CHNT	10x38 500V	2A	2	YE46002000000								
16	FU2	熔断器/Fuse	YINDA	FS-10	2A	1	YE41001000000								
17	S3	露点变送器/Dew-point transducer	CS	CS 217-0EM	POWER=24VDC OUT=4-20mA	1	-----	(1)(2)							
18	S4	温度保护器/Temperature protector	EGO	--	115-320°	1	-----	(1)							
19	S5	热电偶/Thermocouple	SHINI	ST-K	K	1	-----	(1)							
20	PCB	两机一体SDU-U控制器	PUMP	K.SF878500A.04	-----	1	YE80878500300								
21	H1	蜂鸣器/Buzzer	HITPOINT	PK-35A	220V AC/DC	1	YE84003500200								
22	H2	警报指示灯/Alarm indicator	SHINI	LED-3051	230VAC 50Hz	1	YE83305100200	(1)							
23	FM	风扇/Fan	SUNON	DP-200A	230VAC 40W	1	-----	(1)							
24	Y1,Y2,Y3	电磁阀/Solenoid valve	FESTO	MSFW-230-50/60	230VAC 50/60Hz	3	-----	(1)							
25	M1	风机/Blower	SHINI	----	400V 50/60Hz 0.12KW	1	-----	(1)							
整机版本 Ver.D															
注: (1)表示非电控箱内材料; (2)表示选配露点计;															
		制图		版号		F		标题		图号		比例		第 4 张	
		设计		核 准				SDL-160U		SDL-160U-CE-400V-F-4		标准		共 5 张	
		校对						电气元件明细表一				机器电压		400V	
		审核		日期		20170830		SHINI		信易电热机械股份有限公司 Shini Plastics Technologies, Inc.		机器频率		50Hz	
标记		更改前		更改后		更改人		日期							
1		2	3	4	5	6	7	8							

1		2		3		4		5		6		7		8	
序号/NO	符号/Symbol	名称/Name	制造商/Manufacturer	型号/Type	规格/Specification	数量/Number	物料编号/Material number	备注/Remark							
26	M2	风机/Blower	SHINI	----	400V 50/60Hz 15KW	1	----	(1)							
27	EH1	电热管/Heater	SHINI	----	400V 50/60Hz 6.0KW	1	----	(1)							
A		端子排/Terminal board	----	4mm ²	----	9	YE600004.03200								
29			----	4mm ² PE	----	3	YE600004.03500								
30			----	2.5mm ²	----	3	YE600025.03200								
31			----	2.5mm ² PE	----	1	YE600025.03400								
32	X2	端子排/Terminal board	----	2.5mm ²	----	14	YE600025.03200								
33			----	2.5mm ² PE	----	3	YE600025.03400								
34			----	2.5mm ²	----	2	YE600025.03200	(2)							
35			----	2.5mm ²	----	2	YE600025.03200	(3)							
B		端子排/Terminal	----	2.5mm ²	----	6	YE600025.03200								
37	X4, X5	重载接头/Heavy duty connector	SIBAS	HDC-HA-004.1	4P 10A	2	YE6804.1000100	(1)							
38	S10	通信接口板IS-485 (德Dsub-9pin接口)	--	--	--	1	YE9004.8501200	(1)							
39		外壳IS485 (SAL-700G-A-19) 0版	--	--	--	1	YR4.004.8500000	(1)							
40		终端面定件B/GX系列 (霍尼韦尔)	--	--	--	5	YE60000003900								
C															
D															
整机版本 Ver.D		注: (1) 表示非电控箱内材料; (2) 表示选配露点计; (3) 表示选配无热再生装置。													
		制图	版号	F	标题	图号		比例		第 5 张					
		设计	核		SDL-160U	SDI-160U-		标准		共 5 张					
		校对	准		电气元件明细表二	CE-400V-F-5		机器电压		400V					
标记		更改前	更改后	更改人	日期	日期	日期	日期	机器频率	50Hz					
1	2	3	4	5	6	7	8								



信易电热机械股份有限公司
Shini Plastics Technologies, Inc.

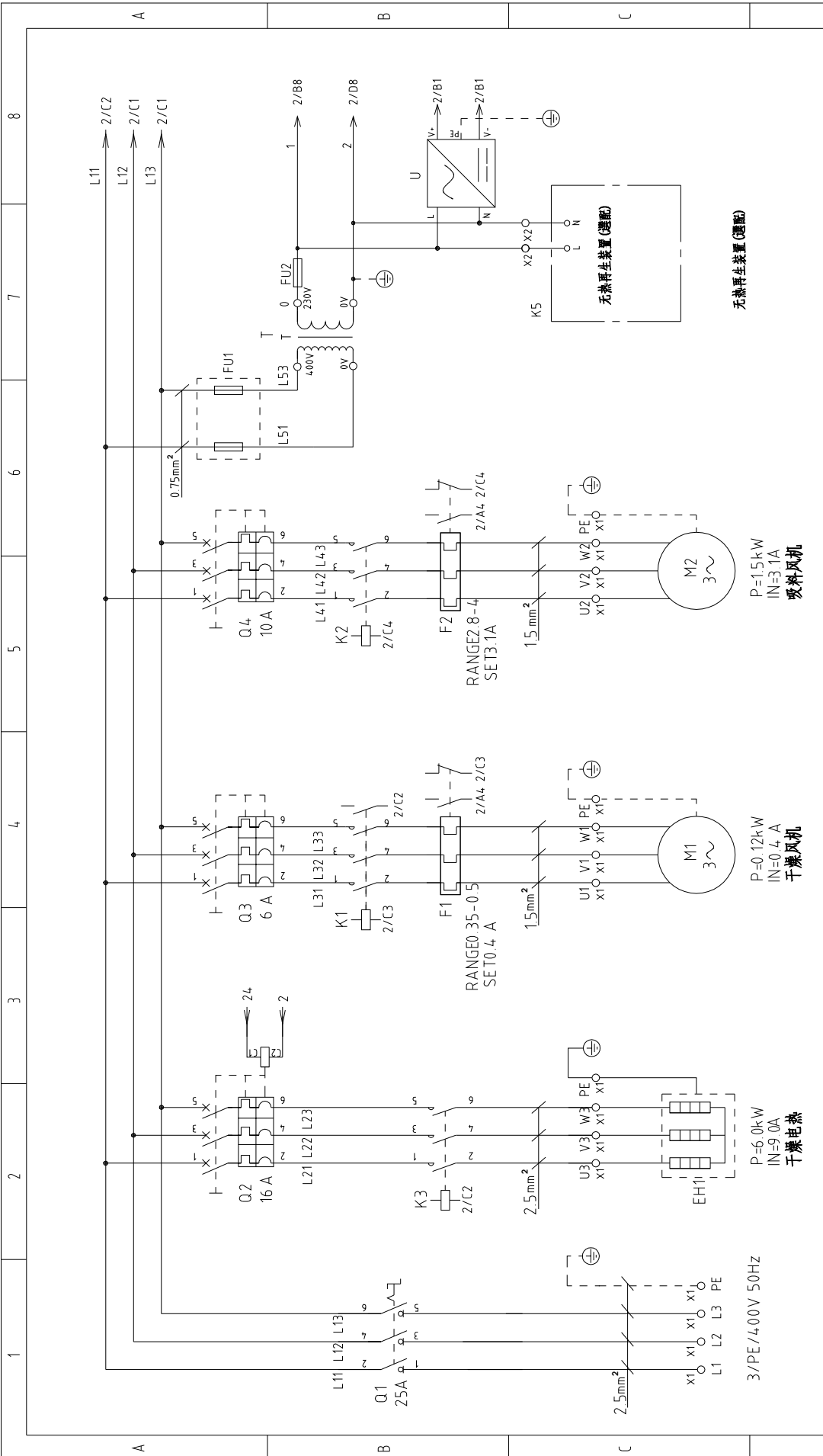

SDL-230U整机版本Ver.B | SDL-230U-HD整机版本Ver.C

1	2	3	4	5	6	7	8
A		B		C		D	
制图	设计	校对	审核	版号	标题	图号	比例
				SDL-230U	SDL-230U-主电路图	SDL-230U-CE-400V-F-1	第 1 张
标记	更改前	更改后	更改人	日期	20170830		共 5 张
							标准
							CE
							机器电压
							400V
							机器频率
							50Hz



无热再生装置 (选配)

P=1.5kW
IN=3.1A
吹料风机

P=0.12kW
IN=3.1A
干热风

P=6.0kW
IN=9.0A
干热风

1 2 3 4 5 6 7 8

A B C D

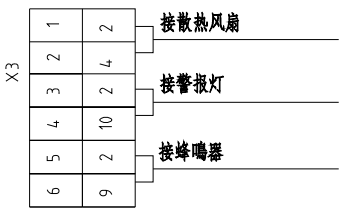
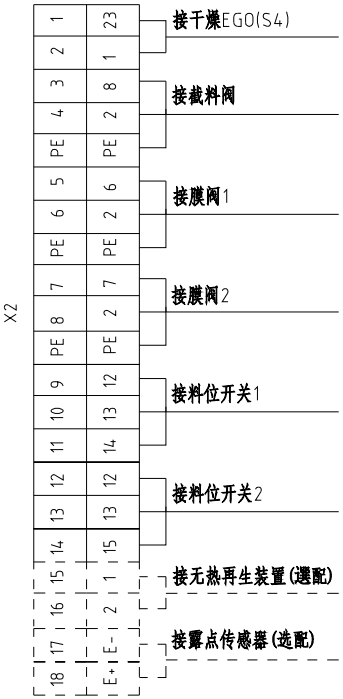
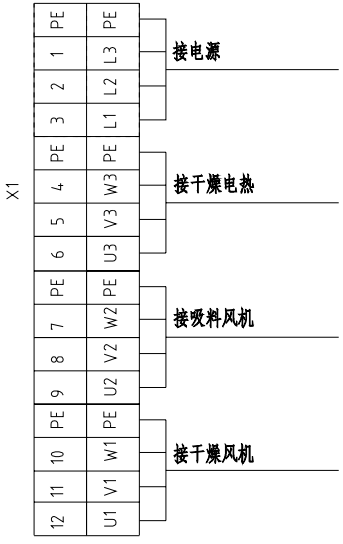
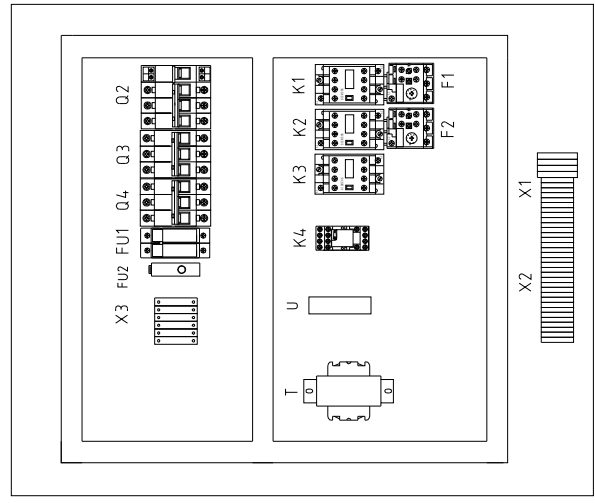
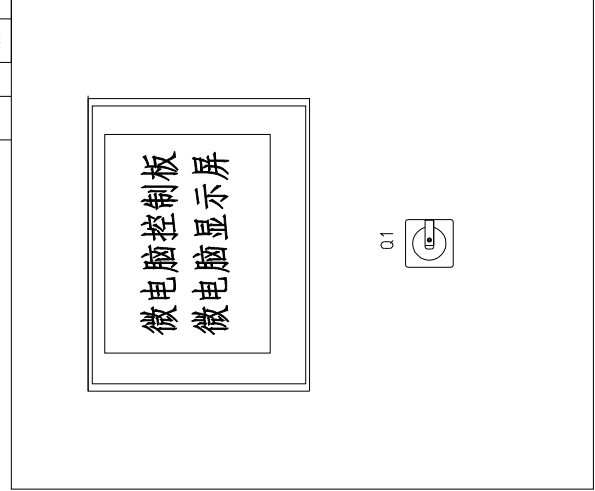

SDL-230U整机版本Ver.B SDL-230U-HD整机版本Ver.C

图号	SDL-230U- 电气元件布置图	比例	第 3 张 共 5 张
标题	SDL-230U	标准	CE
版号	F	机器电压	400V
制图	设计	机器频率	50Hz
日期	20170830		



1 2 3 4 5 6 7 8

1	2	3	4	5	6	7	8	
序号/NO	符号/Symbol	名称/Name	制造商/Manufacturer	型号/Type	规格/Specification	数量/Number	物料编号/Material number	备注/Remark
1	Q1	主电源开关/Main switch	EATON	P1-25/EA/SVB	25A	1	YE10125250000	
2	Q2	断路器/Circuit-breaker	TECO	BM-63C/3016S 3P	16A	1	YE40301603000	
3		励磁抽器/Excitation release	CHINT	MX	230V 50/60Hz	1	YE40023560000	A
4	Q3	断路器/Circuit-breaker	TECO	BM-63C/3006S 3P	6A	1	YE40300603000	
5	Q4	断路器/Circuit-breaker	TECO	BM-63C/3010S 3P	10A	1	YE40301003000	
6	K1	交流接触器/Contactor	SIEMENS	3RT6015-1ANZ1	7A 220V 50/60Hz	1	YE00601521000	
7	K2	交流接触器/Contactor	SIEMENS	3RT6016-1ANZ1	9A 220V 50/60Hz	1	YE00601621000	
8	K3	交流接触器/Contactor	SIEMENS	3RT6018-1ANZ1	16A 220V 50/60Hz	1	YE00601800000	
9	K4	中间继电器/Middle relay	WEIDMULLER	DRM270730LT	230V 50/60Hz 12A	1	YE03270700000	
10	U	直流电源/DC power	MEAN WELL	NES-35-24	OUT=DC24V 15A	1	YE71352400100	
11	T	变压器/Transformer	BAIYUN	BY-0407009	IN=400V OUT=230V 500mA	1	YE70402300800	B
12	F1	热过载继电器/Overload relay	SIEMENS	3RU6116-0FB0	0.35-0.5A	1	YE01161350000	
13	F2	热过载继电器/Overload relay	SIEMENS	3RU6116-1EB0	2.8-4A	1	YE01160280000	
14	FU1	熔断器座 /Fuse base	CHNT	RT28-32	2P	1	YE41032200000	
15		熔断器芯 /Fuse core	CHNT	10x38 500V	2A	2	YE46002000000	
16	FU2	熔断器/Fuse	YINDA	FS-10	2A	1	YE41001000000	
17	S3	露点变送器/Dew-point transducer	CS	CS 217-0EM	POWER=24VDC OUT=4-20mA	1	-----	(1)(2)
18	S4	温度保护器/Temperature protector	EGO	--	115-320°	1	-----	(1)
19	S5	热电偶/Thermocouple	SHINI	ST-K	K	1	-----	(1)
20	PCB	两机一体SDL-U控制器	PUMP	K.SF878500A.04	-----	1	YE80878500300	
21	H1	蜂鸣器/Buzzer	HITPOINT	PK-35A	220V AC/DC	1	YE84003500200	
22	H2	警报指示灯/Alarm indicator	SHINI	LED-3051	230VAC 50Hz	1	YE83305100200	(1)
23	FM	风扇/Fan	SUNON	DP-200A	230VAC 40W	1	-----	(1)
24	Y1,Y2,Y3	电磁阀/Solenoid valve	FESTO	MSFW-230-50/60	230VAC 50/60Hz	3	-----	(1)
25	M1	风机/Blower	SHINI	----	400V 50/60Hz 0.12KW	1	-----	(1)
SDL-230U整机版本Ver.B SDL-230U-HD整机版本Ver.C 注: (1)表示非电控箱内材料; (2)表示选配露点计.								
			制图	版号	F	图号	SDI-230U-CE-400V-F-4	第 4 张
			设计	核		电气元件明细表一	标准	共 5 张
			校对	准			机器电压	400V
			审核	日期	20170830		机器频率	50Hz
标记	更改前	更改后	更改人	日期				

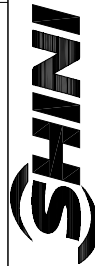

信易电热机械股份有限公司
Shini Plastics Technologies, Inc.

1		2		3		4		5		6		7		8	
序号/NO	符号/Symbol	名称/Name	制造商/Manufacturer	型号/Type	规格/Specification	数量/Number	物料编号/Material number	备注/Remark							
26	M2	风机/Blower	SHINI	----	400V 50/60Hz 15KW	1	----	(1)							
27	EH1	电热器/Heater	SHINI	----	400V 50/60Hz 6.0KW	1	----	(1)							
28	X1	端子排/Terminal board	----	4mm ²	----	9	YE60000403200	A							
29			----	4mm ² PE	----	3	YE60000403500								
30			----	2.5mm ²	----	3	YE60002503200								
31			----	2.5mm ² PE	----	1	YE60002503400								
32	X2	端子排/Terminal board	----	2.5mm ²	----	14	YE60002503200								
33			----	2.5mm ² PE	----	3	YE60002503400								
34			----	2.5mm ²	----	2	YE60002503200	(2)							
35			----	2.5mm ²	----	2	YE60002503200	(3)							
36	X3	端子排/Terminal	----	2.5mm ²	----	6	YE60002503200	B							
37	X4, X5	重载插头/Heavy duty connector	SIBAS	HDC-HA-004.1	4P 10A	2	YE68041000100	(1)							
38	S10	通信接口板/IS-485 (雙Dsub-9pin接頭)	--	--	--	1	YE90048501200	(1)							
39		外殼/IS485 (SLL-700G-A-19) 0版	--	--	--	1	YR40048500000	(1)							
40		終端固定件/F/GX系列 (羅尼希尔)	--	--	--	5	YE60000003900								
C															
D															
SDL-230U 整机版本 Ver.B/SDL-230U-HD 整机版本 Ver.C 注: (1) 表示非电控箱内材料; (2) 表示选配露点计; (3) 表示选配无热再生装置。															
		制图		版号		F		标题		图号		比例		第 5 张	
		设计		核 准				SDL-230U- 电气元件明细表二		SDI-230U- CE-400V-F-5		标准 CE		共 5 张	
		校对		日期		20170830						机器电压		400V	
标记		更改后		更改人		日期		审核				机器频率		50Hz	
更改前															
1		2		3		4		5		6		7		8	



信易電熱機械股份有限公司
Shini Plastics Technologies, Inc.