

- A
- (a) Total input current
 - (b) Main power wire dia.
 - (c) Main power switch
 - (k) Heater current
 - (d1) Drying blower breaker
 - (d2) Drying heater breaker
 - (e1) Drying blower overload relay
 - (f) Drying blower wire dia.
 - (g) Drying blower power
 - (e2) Default drying blower overload relay
 - (h) Heater wire dia.
 - (i) Heater power
 - (h) Drying blower current

B

Mode	Symbol	Ver.	(a)	(b)	(c)	(d1)	(d2)	(e1)	(e2)	(f)	(g)	(h)	(i)	(j)	(k)
HA-30		Ver.B	3.5	2.5	16	6	6	0.14-0.2	0.18	1.5	0.05	0.14	15	2.2	3.3
HA-40		Ver.B	4.9	2.5	16	6	10	0.28-0.4	0.32	1.5	0.12	0.32	15	3.0	4.5
HA-60		Ver.B	6.3	2.5	16	6	10	0.28-0.4	0.32	1.5	0.12	0.32	15	3.9	5.9
HA-100		Ver.B	9.5	2.5	16	6	16	0.45-0.63	0.45	1.5	0.18	0.45	2.5	6.0	9.0
HA-200		Ver.B	18.6	4.0	25	6	25	0.55-0.8	0.65	1.5	0.25	0.65	4.0	12.0	18
HA-400		Ver.B	28.5	6.0	32	6	40	1.1-1.6	1.45	1.5	0.55	1.45	6.0	18.0	27
HA-600		Ver.B	28.5	6.0	32	6	40	1.1-1.6	1.45	1.5	0.55	1.45	6.0	18.0	27
HA-700		Ver.B	38.3	10.0	63	6	50	1.8-2.5	2.3	1.5	1.1	2.45	4.0	24	36

C

版本	Ver.B
----	-------

D

Mark	Before modification	Modified by	Modify date	Date	20170908	Checked by	Proofread by	Designer	Drawer	Version	A	Title	HA-30~700 Parameter List of Circuit Diagram	Drawing NO	HA-30~700-CE-400V-A-1	Scale	Page 1	
	Standard	Totally 20 Pages																
																CE	400V	
																	Frequency	50HZ



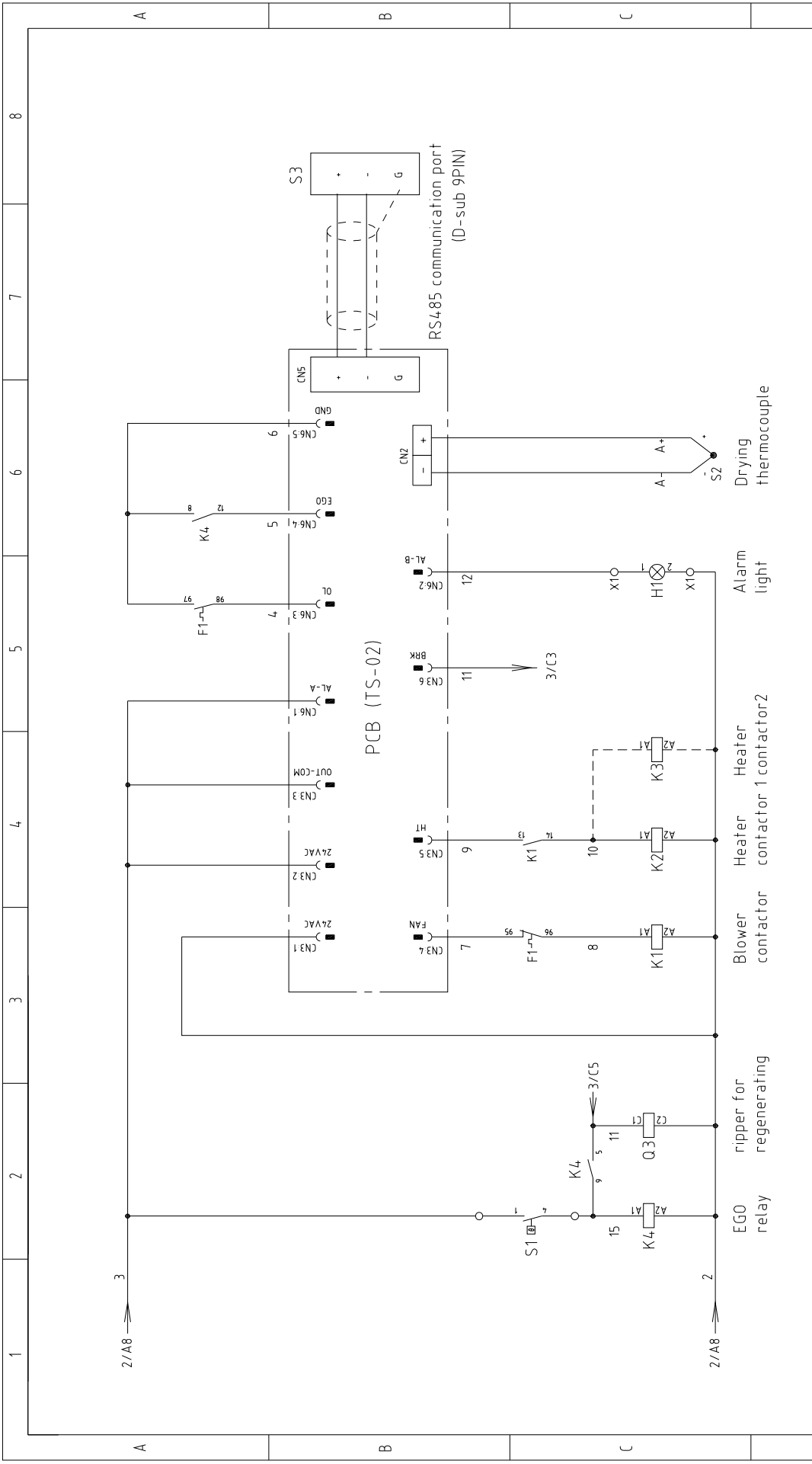

Mark	Before modification	After modification	Modified by	Modify date	Checked by	Proofread by	Designer	Drawer

Version	A	Title	HA-30~700
Approved by		Control Circuit Diagram	HA-30~700-CE-400V-A-3
Date	20170908	SHINI 信易電熱機械股份有限公司 Shini Plastics Technologies, Inc.	

Scale	Standard	CE	Page	3
Voltage	400V	Frequency	Totally	20 Pages
Frequency	50HZ			

版本 Ver.B

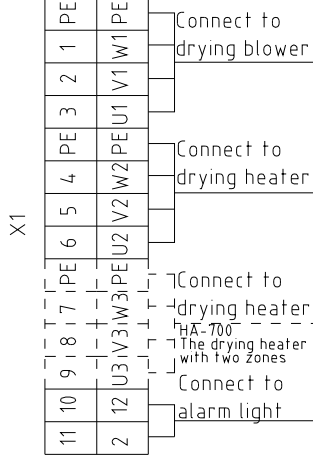
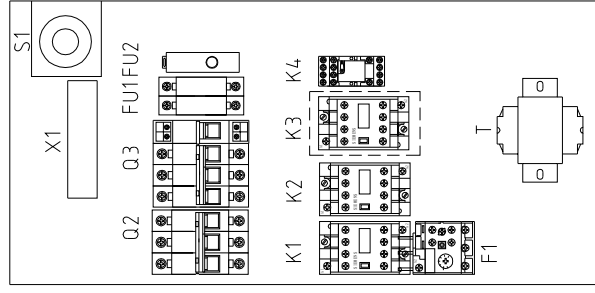
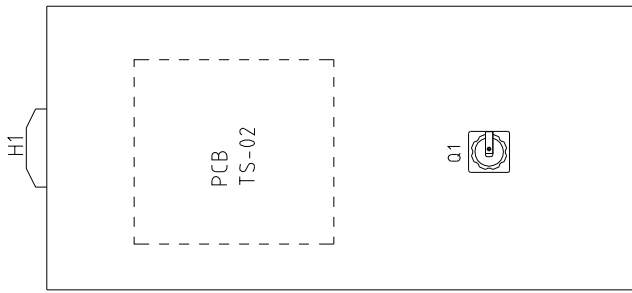

The main power lines directly connect to main power switch disconnect to terminal board.

版本 Ver.B	Title HA-30~700		Scale Standard	Page 4
	Drawing NO HA-30~700-CE-400V-A-4		Standard CE	Totally 20 Pages
	Electrical Components Layout		Voltage 400V	Frequency 50HZ
Mark	Before modification	Modified by	Modify date	Checked by
			20170908	
	Drawer	Designer	Proofread by	Approved by
	Version	A		Date
				20170908



1	2		3	4	5	6	7	8
NO.	Symbol	Name	Manufacturer	Type	Specification	Number	Material number	Remark
1	Q1	Main power switch	EATON	T0-2-1/EA/SVB/16A	16A 3P	1	YE10021160000	
2	Q3	Circuit-breaker	TECO	BM-63C/3006S	6A 3P	1	YE40300603000	
3		Excitation release	CHINT	MX	24V 50/60Hz	1	YE40024000000	A
4	Q2	Circuit-breaker	TECO	BM-63C/3006S	6A 3P	1	YE40300603000	
5	K1	Contactor	SIEMENS	3RT6015-1AB01	7A 1NO 24V 50/60Hz	1	YE00601502500	
6	K2	Contactor	SIEMENS	3RT6016-1AB01	9A 24V 50/60Hz	1	YE00601602500	
7	K4	Middle relay	HONEYWELL	GR-2C-AC24V	24V 50/60Hz	1	YE03022400300	
8	F1	Overload relay	SIEMENS	3RU6116-0BBO	0.14-0.2A 50/60Hz	1	YE01611601300	
9	FU1	Fuse base	CHINT	RT28-32	2P	1	YE41032200000	
10		Fuse core	CHINT	10x38 500V	1A	2	YE46001000100	
11	FU2	Fuse	YINDA	FS-10	6x30mm 2A 250V	1	YE41001000000	B
12	T	Transformer	BAIYUN	--	IN=400V OUT=24V 80VA	1	YE70040005900	
13	PCB	PCB	YUYUN	TS-02(24VAC)(含通讯)	24V 50/60Hz	1	YE80000101200	
14		Control box SSMD(SHD-40U-C-02) ABS+PC(30%)				1	YR40400200000	
15		Lamp cover(SIC-015)				1	YR90441300000	
16		Panel for HA105.5x84.5MM2016 Version sickness>65N/ Pressing plate of display screen SHD-80U-A-43(88x53±0.3x1010				1	YR01105506600/YR900000003300	
17	S1	Temperature protector	EGO	--	115-320 °C	1	BH90115000150	
18	S2	Thermocouple	SHINI	K TYPE	--	1	----	(1)
19	H1	Alarm light	SHINI	LED-3051	24V 50/60Hz	1	YE83305100900	C
20	X1	Terminal	HOLLEYWELL	--	4mm ²	6	YE60000403200	
21					4mm ² PE	2	YE60000403500	
22					2.5mm ²	2	YE60002503200	
23	M1	Blower	--	--	0.05kW	1	----	(1)
24	EH1	Heater	SHINI	--	2.2kW	1	----	(1)
25	S3	D 9-pin communication port (Equipped with screw)	--	--	--	1	YE90048501200	
版本 Ver.B								
Notes: (1)Means it's not the material inside the control box.								
D			Title	HA-30	Drawing NO	HA-30~700-CE-400V-A-5	Scale	Page 5
			A	Electrical Components list 1		CE	Standard	Totally 20 Pages
Mark			Before modification	Modified by	Modify date	After modification	Voltage	400V
			20170908			Frequency	50HZ	
1	2	3	4	5	6	7	8	



1	2		3	4	5	6	7	8
NO.	Symbol	Name	Manufacturer	Type	Specification	Number	Material number	Remark
1	Q1	Main power switch	EATON	T0-2-1/EA/SVB/16A	16A 3P	1	YE10021160000	
2	Q3	Circuit-breaker	TECO	BM-63C/3010S	10A 3P	1	YE40301003000	
3		Excitation release	CHINT	MX	24V 50/60Hz	1	YE40024000000	A
4	Q2	Circuit-breaker	TECO	BM-63C/3006S	6A 3P	1	YE40300603000	
5	K1	Contactor	SIEMENS	3RT6015-1AB01	7A 1NO 24V 50/60Hz	1	YE00601502500	
6	K2	Contactor	SIEMENS	3RT6016-1AB01	9A 24V 50/60Hz	1	YE00601602500	
7	K4	Middle relay	HONEYWELL	GR-2C-AC24V	24V 50/60Hz	1	YE03022400300	
8	F1	Overload relay	SIEMENS	3RU6116-0EB0	0.28-0.4A 690V 50/60Hz	1	YE01161280000	
9	FU1	Fuse base	CHINT	RT28-32	2P	1	YE41032000000	
10		Fuse core	CHINT	10×38 500V	1A	2	YE46001000100	
11	FU2	Fuse	YINDA	FS-10	6×30mm 2A 250V	1	YE41001000000	B
12	T	Transformer	BAIYUN	--	IN=400V OUT=24V 80VA	1	YE70040005900	
13	PCB	PCB	YUYUN	TS-02(24VAC)(含通讯)	24V 50/60Hz	1	YE80000101200	
14		Control box SSMD(SHD-40U-C-02) ABS+PC(30%)				1	YR40400200000	
15		Lamp cover(SIC-015)				1	YR90441300000	
16		Panel for HA105 5×84.5MM2016 Version sickness=65N/ Pressing plate of display screen SHD-80U-A-43(88×53±0.3×1010)				1	YR01105506600/YR900000003300	
17	S1	Temperature protector	EGO	--	115-320 °C	1	BH90115000150	
18	S2	Thermocouple	SHINI	K TYPE	--	1	----	(1)
19	H1	Alarm light	SHINI	LED-3051	24V 50/60Hz	1	YE83305100900	C
20	X1	Terminal	HOLLEYWELL	--	4mm ²	6	YE60000403200	
21					4mm ² PE	2	YE60000403500	
22					2.5mm ²	2	YE60002503200	
23	M1	Blower	--	--	0.12kW	1	----	(1)
24	EH1	Heater	SHINI	--	3.0kW	1	----	(1)
25	S3	D 9-pin communication port (Equipped with screw)	--	--	--	1	YE90048501200	
版本 Ver.B								
Notes: (1)Means it's not the material inside the control box.								
D				A	HA-40	Drawing NO	HA-30~700-CE-400V-A-7	Page 7
				Version	Electrical Components list 1	Standard	CE	Totally 20 Pages
Mark				Designer	Proofread by	Checked by	Modified by	Date
Before modification								20170908
After modification								
				Voltage	Frequency	400V	50HZ	
				1	2	3	4	5
				6	7	8		



信易电热机械股份有限公司
Shini Plastics Technologies, Inc.

1		2		3		4		5		6		7		8	
NO.	Symbol	Name	Manufacturer	Type	Specification	Number	Material number	Remark							
1	Q1	Main power switch	EATON	T0-2-1/EA/SVB/16A	16A 3P	1	YE10021160000								
2	Q3	Circuit-breaker	TECO	BM-63C/3010S	10A 3P	1	YE40301003000								
3	Q2	Excitation release	CHINT	MX	24V 50/60Hz	1	YE40024000000								
4	Q2	Circuit-breaker	TECO	BM-63C/3006S	6A 3P	1	YE40300603000								
5	K1	Contactor	SIEMENS	3RT6015-1AB01	7A 1NO 24V 50/60Hz	1	YE00601502500								
6	K2	Contactor	SIEMENS	3RT6016-1AB01	9A 24V 50/60Hz	1	YE00601602500								
7	K4	Middle relay	HONEYWELL	GR-2C-AC24V	24V 50/60Hz	1	YE03022400300								
8	F1	Overload relay	SIEMENS	3RU6116-0EB0	0.28-0.4A 690V 50/60Hz	1	YE01161280000								
9	FU1	Fuse base	CHINT	RT28-32	2P	1	YE41032200000								
10		Fuse core	CHINT	10×38 500V	1A	2	YE46001000100								
11	FU2	Fuse	YINDA	FS-10	6×30mm 2A 250V	1	YE41001000000								
12	T	Transformer	BAIYUN	--	IN=400V OUT=24V 80VA	1	YE70040005900								
13	PCB	PCB	YUYUN	TS-02(24VAC)(含通讯)	24V 50/60Hz	1	YE80000101200								
14		Control box SSMD(SHD-40U-C-02) ABS+PC(30%)				1	YR40400200000								
15		Lamp cover(SIC-015)				1	YR90441300000								
16		Panel for HA105.5x84.5MM2016 Version sickness>65N/ Pressing plate				1	YR011055056600/YR900000003300								
17	S1	Temperature protector	EGO	--	115-320 °C	1	BH90115000150								
18	S2	Thermocouple	SHINI	K TYPE	--	1	----	(1)							
19	H1	Alarm light	SHINI	LED-3051	24V 50/60Hz	1	YE83305100900								
20	X1	Terminal	HOLLEYWELL	--	4mm ²	6	YE600000403200								
21					4mm ² PE	2	YE600000403500								
22					2.5mm ²	2	YE60002503200								
23	M1	Blower	--	--	0.12kW	1	----	(1)							
24	EH1	Heater	SHINI	--	3.9kW	1	----	(1)							
25	S3	D 9-pin communication port (Equipped with screw)	--	--	--	1	YE90048501200								
版本 Ver.B		Notes: (1)Means it's not the material inside the control box													
D		Title		Drawing NO		Scale		Page		9		20		Pages	
		HA-60		HA-30~700-CE-400V-A-9		Standard		CE		Voltage		400V		Frequency	
		Electrical Components list 1		SHINI		SHINI		SHINI		SHINI		SHINI		SHINI	
		Electrical Components list 1		SHINI		SHINI		SHINI		SHINI		SHINI		SHINI	
Mark		Before modification		Modified by		Modify date		Checked by		Date		20170908		50HZ	
1		2		3		4		5		6		7		8	



1	2		3	4	5	6	7	8
NO.	Symbol	Name	Manufacturer	Type	Specification	Number	Material number	Remark
1	Q1	Main power switch	EATON	T0-2-1/E/SVB/16A	16A 3P	1	YE10021160000	
2	Q3	Circuit-breaker	TECO	BM-63C/3016S	16A 3P	1	YE40301603000	
3		Excitation release	CHINT	MX	24V 50/60Hz	1	YE40024000000	A
4	Q2	Circuit-breaker	TECO	BM-63C/3006S	6A 3P	1	YE40300603000	
5	K1	Contactor	SIEMENS	3RT6015-1AB01	7A 1NO 24V 50/60Hz	1	YE00601502500	
6	K2	Contactor	SIEMENS	3RT6018-1AB01	16A 24V 50/60Hz	1	YE00601802500	
7	K4	Middle relay	HONEYWELL	GR-2C-AC24V	24V 50/60Hz	1	YE03022400300	
8	F1	Overload relay	SIEMENS	3RU6116-0GB0	0.45-0.63A 690V 50/60Hz	1	YE01161450000	
9	FU1	Fuse base	CHINT	RT28-32	2P	1	YE41032200000	
10		Fuse core	CHINT	10×38 500V	1A	2	YE46001000100	
11	FU2	Fuse	YINDA	FS-10	6×30mm 2A 250V	1	YE41001000000	B
12	T	Transformer	BAIYUN	--	IN=400V OUT=24V 80VA	1	YE70040005900	
13	PCB	PCB	YUYUN	TS-02(24VAC)(含通讯)	24V 50/60Hz	1	YE80000101200	
14		Control box SSMD(SHD-40U-C-02), ABS+PC(30%)				1	YR40400200000	
15		Lamp cover(SIC-015)				1	YR90441300000	
16		Panel for HA105 5x84.5MM2016 Version sickness=65N/ Pressing plate			of display screen SHD-80U-A-43(88x53±0.3x1.0)	1	YR01105506600/YR90000003300	
17	S1	Temperature protector	EGO	--	115-320 °C	1	BH90115000150	
18	S2	Thermocouple	SHINI	K TYPE	--	1	----	(1)
19	H1	Alarm light	SHINI	LED-3051	24V 50/60Hz	1	YE83305100900	
20	X1	Terminal	HOLLEYWELL	--	4mm ²	6	YE60000403200	
21					4mm ² PE	2	YE60000403500	
22					2.5mm ²	2	YE60002503200	
23	M1	Blower	--	--	0.18kW	1	----	(1)
24	EH1	Heater	SHINI	--	6kW	1	----	(1)
25	S3	D 9-pin communication port (Equipped with screw)	--	--	--	1	YE90048501200	
版本 Ver.B								
Notes: (1)Means it's not the material inside the control box.								
D				Title		Drawing NO		Page
				HA-100		HA-30~700-CE-400V-A-11		11
				Electrical Components list 1		Standard		CE
						Voltage		400V
Mark				Before modification		Frequency		50HZ
1				2		3		4
1				2		3		4
5				6		7		8

1	2	3	4	5	6	7	8	
NO.	Symbol	Name	Manufacturer	Type	Specification	Number	Material number	Remark
26		Shell RS485(SAL-700G-A-19)0	--	--	--	1	YR40048500000	
27		Terminal block E/GKseries(honeywell)			PCS	5	YE60000003900	
A								
B								
C								

版本 Ver.B	Notes: (1)Means it's not the material inside the control box.										
	Scale	Standard	CE	Page	12						
Mark	Before modification			After modification			Voltage			400V	
	Modified by			Modify date			Frequency			50HZ	
D		Title		Version		A		Drawing NO		8	
		HA-100						HA-30~700-CE-400V-A-12		Totally 20 Pages	
		Electrical Components List 2		Approved by							
				Date		20170908					
		信易电热机械股份有限公司									
		Shini Plastics Technologies, Inc.									

1	2		3	4	5	6	7	8
NO.	Symbol	Name	Manufacturer	Type	Specification	Number	Material number	Remark
1	Q1	Main power switch	EATON	P1-25/EA/SVB/25A	25A 3P	1	YE10125250000	
2	Q3	Circuit-breaker	TECO	BM-63C/3025S	25A 3P	1	YE40302503000	
3		Excitation release	CHINT	MX	24V 50/60Hz	1	YE40024000000	A
4	Q2	Circuit-breaker	TECO	BM-63C/3006S	6A 3P	1	YE40300603000	
5	K1	Contactor	SIEMENS	3RT6015-1AB01	7A 1NO 24V 50/60Hz	1	YE00601502500	
6	K2	Contactor	SIEMENS	3RT6027-1AC20	32A 24V 50/60Hz	1	YE00602702600	
7	K4	Middle relay	HONEYWELL	GR-2C-AC24V	24V 50/60Hz	1	YE03022400300	
8	F1	Overload relay	SIEMENS	3RU6116-0HB0	0.55-0.8A 690V 50/60Hz	1	YE01161550000	
9	FU1	Fuse base	CHINT	RT28-32	2P	1	YE41032200000	
10		Fuse core	CHINT	10×38 500V	1A	2	YE46001000100	
11	FU2	Fuse	YINDA	FS-10	6×30mm 3A 250V	1	YE41001000000/YE46630500200	B
12	T	Transformer	BAIYUN	--	IN=400V OUT=24V 80VA	1	YE70040005900	
13	PCB	PCB/SSMD(SHD-40U-C-02) ABS+PC(30%)		TS-02(24VAC)(含通讯)	24V 50/60Hz	1	YE80000101200/YR40400200000	
14		Lamp cover(SIC-015)				1	YR90441300000	
15		Panel for HA105 5×84.5MM2016 Version sickness=65N/ Pressing plate of display screen SHD-80U-A-43(88×53±0.3×1.00)				1	YR01105506600/YR9000000003300	
16	S1	Temperature protector	EGO	--	115~320 °C	1	BH90115000150	
17	S2	Thermocouple	SHINI	K TYPE	--	1	----	(1)
18	H1	Alarm light	SHINI	LED-3051	24V 50/60Hz	1	YE83305100900	
19	X1	Terminal	HOLLEYWELL	--	2.5mm ²	2	YE60002503200	C
20	X1	Terminal	HOLLEYWELL	--	4mm ²	6	YE60000403200	
21					4mm ² PE	2	YE60000403500	
22	M1	Blower	--	--	0.25kW	1	----	(1)
23	EH1	Heater	SHINI	--	12kW	1	----	(1)
24	S3	D 9-pin communication port (Equipped with screw)	--	--	--	1	YE90048501200	
25		Shell RS485(SAL-700G-A-1910)	--	--	--	1	YR40048500000	
版本 Ver.B								
Notes: (1)Means it's not the material inside the control box.								
Drawing NO			Title			Scale		
HA-30~700-CE-400V-A-13			HA-200 Electrical Components list 1			Standard		
CE			Page			Totally		
Voltage			400V			Pages		
Frequency			50HZ			50HZ		
1	2		3	4	5	6	7	8



1	2		3	4	5	6	7	8
NO.	Symbol	Name	Manufacturer	Type	Specification	Number	Material number	Remark
1	Q1	Main power switch	EATON	P1-32/EA/SVB 32A	32A 3P	1	YE10323200000	
2	Q3	Circuit-breaker	TECO	BM-63C/304.0S	40A 3P	1	YE40304003000	
3		Excitation release	CHINT	MX	24V 50/60Hz	1	YE40024000000	A
4	Q2	Circuit-breaker	TECO	BM-63C/3006S	6A 3P	1	YE40300603000	
5	K1	Contactor	SIEMENS	3RT6015-1AB01	7A 1NO 24V 50/60Hz	1	YE00601502500	
6	K2	Contactor	SIEMENS	3RT6028-1ACZ0	38A 24V 50/60Hz	1	YE00602802600	
7	K4	Middle relay	HONEYWELL	GR-2C-AC24V	24V 50/60Hz	1	YE03022400300	
8	F1	Overload relay	SIEMENS	3RU6116-1AB0	1.1-1.6A 690V 50/60Hz	1	YE01160110000	
9	FU1	Fuse base	CHINT	RT28-32	2P	1	YE41032200000	
10		Fuse core	CHINT	10×38 500V	1A	2	YE46001000100	
11	FU2	Fuse	YINDA	FS-10	6×30mm 3A 250V	1	YE41001000000/YE46630500200	B
12	T	Transformer	BAIYUN	--	IN=400V OUT=24V 80VA	1	YE70040005900	
13	PCB	PCB/SSMD(SHD-40U-C-02) ABS+PC(30%)		TS-02(24VAC)(含通讯)	24V 50/60Hz	1	YE80000101200/YR40400200000	
14		Lamp cover(SIC-015)				1	YR90441300000	
15		Panel for HA.105 5×84, 5MM2016 Version sickness=65N/ Pressing plate of display screen SHD-80U-A-43188X53±0.3x1.010				1	YR01105506600/YR9000000003300	
16	S1	Temperature protector	EGO	--	115-320 °C	1	BH90115000150	
17	S2	Thermocouple	SHINI	K TYPE	--	1	----	(1)
18	H1	Alarm light	SHINI	LED-3051	24V 50/60Hz	1	YE83305100900	
19	X1	Terminal	HOLLEYWELL	--	6mm ²	3	YE60000603200	C
20					6mm ² PE	1	YE60000603500	
21					4.0mm ²	3	YE60000403200	
22					4.0mm ² PE	1	YE60000403500	
23					2.5mm ²	2	YE60002503200	
24	M1	Blower	--	--	0.55kW	1	----	(1)
25	EH1	Heater	SHINI	--	18kW	1	----	(1)
版本 Ver.B								
Notes: (1)Means it's not the material inside the control box.								
D				Title	HA-400	Drawing NO	HA-30~700-CE-400V-A-15	Page
				Version	A	Electrical Components list 1	Standard	15
				Designer		SHINI	CE	Totally 20
				Proofread by		SHINI	Voltage	400V
Mark				Modified by	20170908	SHINI	Frequency	50HZ
1	2	3	4	5	6	7	8	



1	2	3	4	5	6	7	8	
NO.	Symbol	Name	Manufacturer	Type	Specification	Number	Material number	Remark
26	S3	D 9-pin communication port (Equipped with screw)	--	--	--	1	YE90048501200	
27		Shell RS485(SAL-700G-A-19)0	--	--	--	1	YR40048500000	
28		Terminal block E/GKseries(honeywell)			PCS	5	YE60000003900	A
A								
B								
C								
D								
版本 Ver.B Notes: (1)Means it's not the material inside the control box.								
Title HA-400 Electrical Components List 2			Version A		Drawing NO HA-30~700-CE-400V-A-16		Scale CE	Page 16
 信易電熱機械股份有限公司 Shini Plastics Technologies, Inc.			Approved by		Standard CE		Voltage 400V	Pages Totally 20
Mark Before modification			Date 20170908		Frequency		50HZ	8

1	2		3	4	5	6	7	8
NO.	Symbol	Name	Manufacturer	Type	Specification	Number	Material number	Remark
1	Q1	Main power switch	EATON	P1-32/EA/SVB 32A	32A 3P	1	YE10323200000	
2	Q3	Circuit-breaker	TECO	BM-63C/304.0S	40A 3P	1	YE40304003000	
3	Q2	Excitation release	CHINT	MX	24V 50/60Hz	1	YE40024000000	A
4	Q2	Circuit-breaker	TECO	BM-63C/3006S	6A 3P	1	YE40300603000	
5	K1	Contactor	SIEMENS	3RT6015-1AB01	7A 1NO 24V 50/60Hz	1	YE00601502500	
6	K2	Contactor	SIEMENS	3RT6028-1AC20	38A 24V 50/60Hz	1	YE00602802600	
7	K4	Middle relay	HONEYWELL	GR-2C-AC24V	24V 50/60Hz	1	YE03022400300	
8	F1	Overload relay	SIEMENS	3RU6116-1AB0	1.1-1.6A 690V 50/60Hz	1	YE01160110000	
9	FU1	Fuse base	CHINT	RT28-32	2P	1	YE41032200000	
10		Fuse core	CHINT	10×38 500V	1A	2	YE46001000100	
11	FU2	Fuse	YINDA	FS-10	6×30mm 3A 250V	1	YE41001000000/YE46630500200	B
12	T	Transformer	BAIYUN	--	IN=400V OUT=24V 80VA	1	YE70040005900	
13	PCB	PCB/SSMD(SHD-4.0U-C-02) ABS+PC(30%)		TS-02(24VAC)(含通讯)	24V 50/60Hz	1	YE80000101200/YR40400200000	
14		Lamp cover(SIC-015)				1	YR90441300000	
15		Panel for HA105 5×84, 5MM2016 Version sickness>65N/ Pressing plate of display screen SHD-80U-A-43188×53±0.3×1.010		--	115~320 °C	1	YR01105506600/YR9000000003300	
16	S1	Temperature protector	EGO	--	--	1	BH90115000150	
17	S2	Thermocouple	SHINI	K TYPE	--	1	----	(1)
18	H1	Alarm light	SHINI	LED-3051	24V 50/60Hz	1	YE83305100900	
19	X1	Terminal	----	--	6mm ²	3	YE60000603200	C
20					6mm ² PE	1	YE60000603500	
21					4.0mm ²	3	YE60000403200	
22					4.0mm ² PE	1	YE60000403500	
23					2.5mm ²	2	YE60002503200	
24	M1	Blower	--	--	0.55kW	1	----	(1)
25	EH1	Heater	SHINI	--	18kW	1	----	(1)
版本 Ver.B								
Notes: (1)Means it's not the material inside the control box.								
D				Drawing NO	HA-600	Scale	Page	17
				Electrical Components list 1	HA-30~700-CE-400V-A-17	Standard	CE	Totally 20 Pages
Mark				Before modification	Modified by	Modify date	Voltage	400V
				20170908	Date	Frequency	50HZ	
1	2	3	4	5	6	7	8	



信易电热机械股份有限公司
Shini Plastics Technologies, Inc.

1	2	3	4	5	6	7	8	
NO.	Symbol	Name	Manufacturer	Type	Specification	Number	Material number	Remark
26	S3	D 9-pin communication port (Equipped with screw)	--	--	--	1	YE90048501200	
27		Shell RS485(SAL-700G-A-1910)	--	--	--	1	YR40048500000	
28		Terminal block E/GKseries(honeywell)			PCS	5	YE60000003900	A
A								
B								
C								
D								
版本 Ver.B Notes: (1)Means it's not the material inside the control box.								
			Version	Title		Scale		Page
			Approved by	HA-600		Standard		18
			Date	Electrical Components List 2		CE		Totally 20 Pages
			20170908	 信易電熱機械股份有限公司 Shini Plastics Technologies, Inc.		Voltage		400V
			20170908			Frequency		50HZ
1 2 3 4 5 6 7 8								

1	2		3	4	5	6	7	8
NO.	Symbol	Name	Manufacturer	Type	Specification	Number	Material number	Remark
1	Q1	Main power switch	EATON	P3-63/EA/SVB 63A	63A 3P 690V 50/60Hz	1	YE10636300000	
2	Q3	Circuit-breaker	TECO	BM-63C/3050S	50A 3P	1	YE40305003000	
3		Excitation release	CHINT	MX	24V 50/60Hz	1	YE40024000000	A
4	Q2	Circuit-breaker	TECO	BM-63C/3006S	6A 3P	1	YE40300603000	
5	K1	Contactor	SIEMENS	3RT6015-1AB01	7A 1NO 24V 50/60Hz	1	YE00601502500	
6	K2 K3	Contactor	SIEMENS	3RT6027-1AC20	32A 24V 50/60Hz	2	YE00602702600	
7	K4	Middle relay	HONEYWELL	GR-2C-AC24V	24V 50/60Hz	1	YE03022400300	
8	F1	Overload relay	SIEMENS	3RU6116-1CB0	18-2.5A 690V 50/60Hz	1	YE01160180000	
9	FU1	Fuse base	CHINT	RT28-32	2P	1	YE41032200000	
10		Fuse core	CHINT	10×38 500V	1A	2	YE46001000100	
11	FU2	Fuse	YINDA	FS-10	6×30mm 5A 250V	1	YE41001000000/YE46630500100	B
12	T	Transformer	BAIYUN	--	IN=400V OUT=24V 120VA	1	YE70402400700	
13	PCB	PCB/SSMD(SHD-4.0U-C-02) ABS+PC(30%)		TS-02(24VAC)(含通讯)	24V 50/60Hz	1	YE80000101200/YR40400200000	
14		Lamp cover(SIC-015)				1	YR90441300000	
15		Panel for HA105 5×84.5MM2016 Version sickness=65N/ Pressing plate of display screen SHD-80U-A-43188×53±0.3×1.010		--	115~320 °C	1	YR01105506600/YR9000000003300	
16	S1	Temperature protector	EGO	--	--	1	BH90115000150	
17	S2	Thermocouple	SHINI	K TYPE	--	1	----	(1)
18	H1	Alarm light	SHINI	LED-3051	24V 50/60Hz	1	YE83305100900	
19	X1	Terminal	HOLLEYWELL	--	6mm ²	6	YE60000603200	C
20					6mm ² PE	2	YE60000603500	
21					4.0mm ²	3	YE60000403200	
22					4.0mm ² PE	1	YE60000403500	
23					2.5mm ²	2	YE60002503200	
24	M1	Blower	--	--	1.1kW	1	----	(1)
25	EH1EH2	Heater	SHINI	--	12kW	2	----	(1)
版本 Ver.B								
Notes: (1)Means it's not the material inside the control box.								
D				Drawing No	HA-700	HA-30~700-CE-400V-A-19	Scale	Page
				Title	Electrical Components list 1	CE	Standard	Page
				Version	A	Voltage	400V	Totally
				Approved by		Frequency	50HZ	20
Mark				Before modification	Modified by	Modify date	Date	20170908
1				2	3	4	5	6
7				8	9	10	11	12



1	2	3	4	5	6	7	8	
NO.	Symbol	Name	Manufacturer	Type	Specification	Number	Material number	Remark
26	S3	D 9-pin communication port (Equipped with screw)	--	--	--	1	YE90048501200	
27		Shell RS485(SAL-700G-A-1910)	--	--	--	1	YR40048500000	
28		Terminal block E/GKseries(honeywell)			PCS	5	YE60000003900	A
A								
B								
C								
D								
版本 Ver.B Notes: (1)Means it's not the material inside the control box.								
Title HA-700 Electrical Components List 2			Drawing NO HA-30~700-CE-400V-A-20			Scale Standard CE		Page 20 Totaly 20 Pages
 SHINI 信易電熱機械股份有限公司 Shini Plastics Technologies, Inc.				Voltage 400V		Frequency 50HZ		Mark Before modification Modified by Modify date After modification Checked by Date 20170908
1	2	3	4	5	6	7	8	

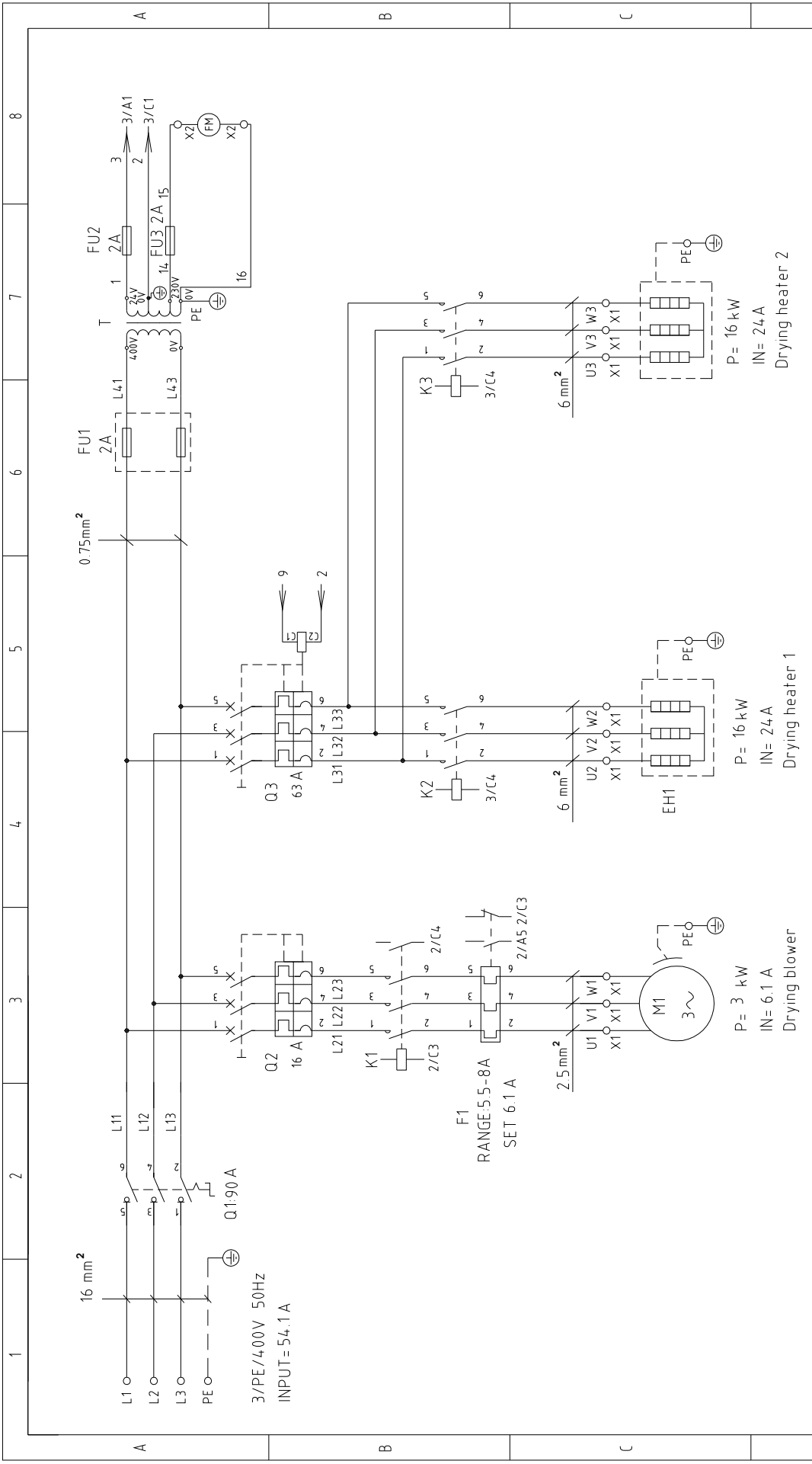

版本 Ver.A	Drawer	Designer	Proofread by	Checked by	Date	Version	0	Title	HA-1000	Drawing NO	HA-1000-CE-400V-0-1	Scale	Page 1
												Standard	Totally 5
Mark	Before modification	Modified by	Modified date									Voltage	400V
												Frequency	50HZ



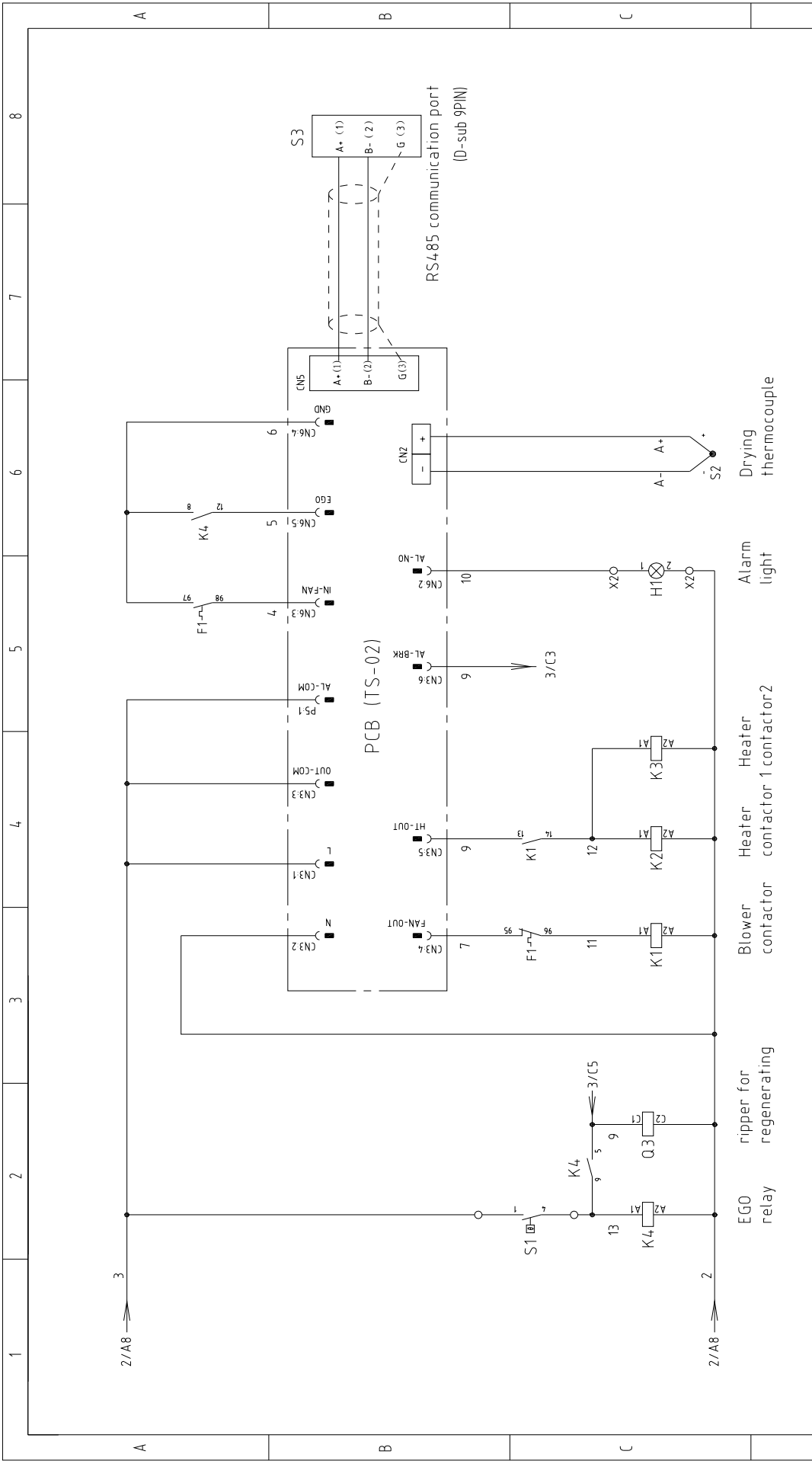

版本 Ver. A	Drawing No		HA-1000		Title		HA-1000-CE-400V-0-2		Scale		Page 2	
	Designer	Approved by	Control Circuit Diagram		Version		0		Standard		Totally 5 Pages	
Mark	Modified by	Modified date	Checked by	Date	Proofread by		20170825		Voltage		400V	
Before modification	After modification				FAN-OUT		3/C3		Frequency		50HZ	
1	2	3	4	5	6	7	8	SHINI		信易电热机械股份有限公司 Shini Plastics Technologies, Inc.		

1 2 3 4 5 6 7 8

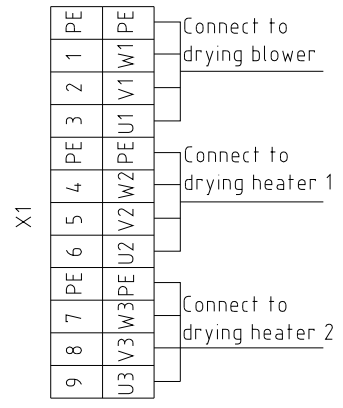
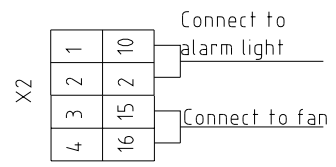
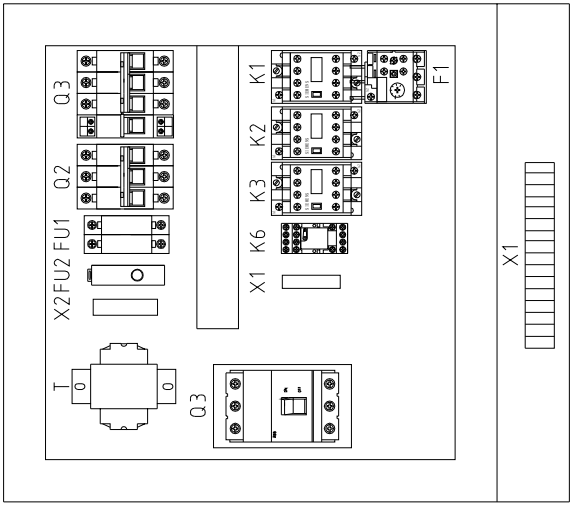
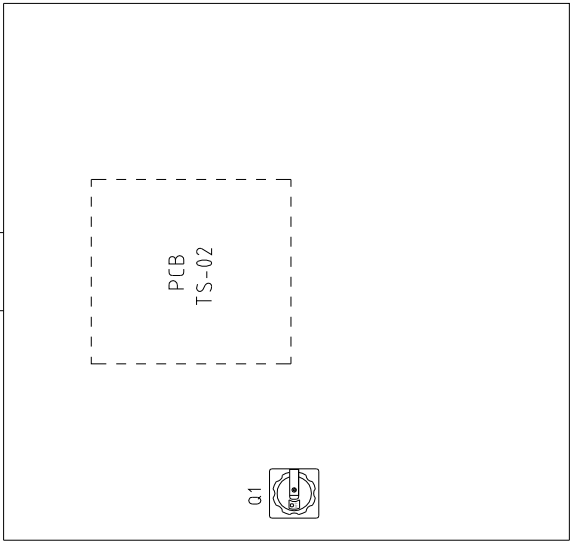

版本 Ver. A

Mark	Before modification	Modified by	Modify date	Checked by	Proofread by	Designer	Drawer	Version	0	Title	HA-1000	Drawing NO	HA-1000-CE-4,00V-0-3	Scale	Standard	CE	Page	3
	After modification							Approved by		Electrical Components Layout							Totally	5
			20170825					Date	20170825								Voltage	400V
																	Frequency	50HZ



1 2 3 4 5 6 7 8

1	2		3	4	5	6	7	8
NO.	Symbol	Name	Manufacturer	Type	Specification	Number	Material number	Remark
1	Q1	Breaker interlock	--	A1A125TMF90/9003PFF	90A	1	YE4.1109200000	
2	Q3	Circuit-breaker	TECO	BM-63C	63A 3P	1	YE4.0306303000	
3		Excitation release	CHINT	MX	24V 50/60Hz	1	YE4.0024.000000	A
4	Q2	Circuit-breaker	TECO	BM-63C	16A 3P	1	YE4.0301603000	
5	K1	Contactor	SIEMENS	3RT6016-1AB01	24V 50/60Hz NO	1	YE00601602500	
6	K2 K3	Contactor	SIEMENS	3RT6027-1AB01	24V 50/60Hz	1	YE00602702600	
7	K4	Middle relay	HONEYWELL	GR-2C-AC24V	24V 50/60Hz	1	YE030224.00300	
8	F1	Thermo overload relay	SIEMENS	3RU6116-1HB0	5.5-8A 50/60Hz	1	YE01160550000	
9	FU1	Fuse	CHINT	RT18-32	2P	1	YE4.1032200000	
10		Fuse core	CHINT	10×38 500V	2A	2	YE4.6002000100	
11	FU2	Fuse	YINDA	FS-10	6×30mm 2A 250V	1	YE4.1001000000/YE4.6630200000	B
12	T	Transformer	BAIYUN	--	IN=400V OUT=24V 80VA	1	YE7004.0005900	
13	PCB	PCB	YUYUN	TS-02(24VAC)(各通讯)	24V 50/60Hz	1	YE80000101200	
14		Control box SSMD (SHD-400-C-02)ABS+PC(30%)	--	--	PCS	1	YR404.00200000	
15		Lamp cover(SIC-015)	--	--	PCS	1	YR9044.1300000	
16		Panel for HA105.5×84.5MM2016 Version sickness>65N	--	--	PCS	1	YR01105506600	
17		Pressing plate of display screen SHD-800-A-4.3(88×53×0.3×1.0)	--	--	PCS	1	YR90000003300	
18	S1	Temperature protector	EGO	--	115-320 °C	1	BH90115000150	
19	S2	Thermocouple	SHINI	K TYPE	--	1	----	(1)
20	H1	Alarm indicator	SHINI	LED-3051	24V 50/60Hz	1	YE83305100900	
21	X1	Connection terminalGK6(honeywell)	--	--	6mm ²	6	YE60000603200	
22		Connection terminal GK6PE(honeywell)	--	--	6mm ² PE	2	YE60000603500	
23		Spring wiring terminal SK4(honeywell)	--	--	4mm ²	3	YE60000403200	
24		Connection terminalSK4PE(honeywell)	--	--	4mm ² PE	2	YE6104.1000000	
25		Connection terminalGK16PB(honeywell)	--	--	16mm ² PE	1	YE60001603500	
版本 Ver.A								
Notes: (1)Means it's not the material inside the control box.								
D				Drawing NO	HA-1000	HA-1000-CE-4.00V-0-4	Scale	Page 4
				Title	Electrical Components list 1	Standard	CE	Page 5
				Version	0	Approved by	Voltage	400V
				Designer		Date	Frequency	50HZ
Mark				Before modification	Modified by	Modify date	Checked by	20170825
1	2	3	4	5	6	7	8	8



