

# **SG-36E**

**"Standard" Central Granulators**

Date: Nov. 2020

Version: Ver.B (English)





## Contents

<b>1. General Description .....</b>	<b>7</b>
1.1 Coding Principle.....	8
1.2 Feature .....	8
1.3 Technical Specifications .....	10
1.4 Safety Regulations.....	11
1.4.1 Safety Signs and Labels.....	11
1.4.2 Transportation and Storage of the Machine .....	13
1.5 Exemption Clause.....	15
<b>2. Structural Features and Working Principle.....</b>	<b>16</b>
2.1 General Description .....	16
2.1.1 Working Principle.....	16
2.2 Safety System.....	17
2.2.1 Emergency Stop.....	17
2.2.2 Safety Switch.....	17
2.2.3 Locking Screw .....	18
2.3 Optional Accessories .....	19
2.3.1 Special Screen .....	19
2.3.2 Full-receiver Alarm Device .....	19
2.3.3 Feed Hopper with Magnet .....	19
2.3.4 Flywheel .....	19
<b>3. Installation and Debugging .....</b>	<b>20</b>
3.1 Installation Notice.....	21
3.2 Installation Place.....	22
3.3 Installation of Blade Rest and Bearing.....	22
3.4 Installation of Belt Pulley and Motor.....	23
3.5 Installation of Fixed Blades and Rotating Blades.....	25
3.6 Installation of Regrind Storage Bin, Screen and Screen Bracket.....	26
3.7 Installation of Screen, Screen Frame and Storage Bin .....	26
<b>4. Operation Guide .....</b>	<b>28</b>
4.1 Prestart Check .....	28

4.1.1	Two Hours After First Start .....	28
4.2	Power Connection.....	28
4.3	Start / Stop of the Machine .....	29
4.4	Open the Feed Box.....	30
<b>5.</b>	<b>Trouble Shooting.....</b>	<b>31</b>
5.1	Granulator Can Not Work .....	31
<b>6.</b>	<b>Maintenance and Repair .....</b>	<b>32</b>
6.1	Repair .....	33
6.1.1	Changing the Blade .....	33
6.2	Transmission .....	37
6.2.1	Daily Maintenance of V-belt.....	37
6.2.2	Adjust the V-belt .....	38
6.3	Lubrication .....	38
6.3.1	Lubricating Oils.....	38
6.3.2	Lubricating Method.....	38
6.4	Maintenance .....	39
6.4.1	Daily Maintenance .....	39
6.4.2	Weekly Checking.....	39
6.4.3	Monthly Checking .....	40
6.5	Cleaning.....	40
6.6	Maintenance Schedule .....	42
6.6.1	About the Machine.....	42
6.6.2	Check After Installation.....	42
6.6.3	Daily Check .....	42
6.6.4	Weekly Check .....	42
6.6.5	Monthly Check.....	42
6.6.6	Check Half-yearly or Every 1000 Running Hours .....	43
6.6.7	3 year Checking .....	43

### Form index

Chart 1-1: Technical Specifications .....	10
---	----

Chart 6-1: Attached form, Cutters and other Fixing ScrewTorque.....36

### Picture index

Picture 1-1: Dimensions .....10

Picture 2-1: Working Principle .....16

Picture 2-2: Emergency Stop Switch .....17

Picture 2-3: Safety Switch .....17

Picture 2-4: Locking Screw.....18

Picture 3-1: Installation Space.....21

Picture 3-2: Installation Place .....22

Picture 3-3: Installation of Blade Rest and Bearing .....22

Picture 3-4: Installation of Belt Pulley and Motor 1 .....23

Picture 3-5: Installation of Belt Pulley and Motor 2 .....23

Picture 3-6: Installation of Belt Pulley and Motor 3 .....23

Picture 3-7: Installation of Belt Pulley and Motor 4 .....24

Picture 3-8: Installation of Belt Pulley and Motor 5 .....24

Picture 3-9: Installation of Fixed Blades and Rotating Blades .....25

Picture 3-10: Installation of Regrind Storage Bin, Screen and Screen Bracket .26

Picture 3-11: Installation of Screen, Screen Frame and Storage Bin 1.....26

Picture 3-12: Installation of Screen, Screen Frame and Storage Bin 2.....27

Picture 3-13: Installation of Screen, Screen Frame and Storage Bin 3.....27

Picture 3-14: Installation of Screen, Screen Frame and Storage Bin 4.....27

Picture 4-1: Start / Stop of the Machine.....29

Picture 6-1: Remove the Fixed Blades .....33

Picture 6-2: Blades Installation Adjusting .....34

Picture 6-3: Installation of Rotating and Fixed Blade.....35

Picture 6-4: Daily Maintenance of V-belt .....37

Picture 6-5: Adjust the V-belt.....38

Picture 6-6: Bearing Cover .....39

Picture 6-7: Lock Screw.....39



# 1. General Description



Please read this manual carefully before using this machine in order to operate correctly against any damage caused due to improper operation.



Note!

Always take great care when the knives are within reach, they are very sharp and can cause personal injury.



Forbidden to process flammable or toxic material!

SG-36E series of "Standard" central granulators are built to conform to sound-proof models both in safety configuration and operation security. They are suitable for centralized recycling of wastes and rejected products from injection, blow moulding and extrusion lines. The granulators feature optimal structure, easy operation and quick blades changing. Staggered rotating blades can easily grab and cut through the materials and ensures low energy consumption.



Model: SG-3675E

## 1.1 Coding Principle

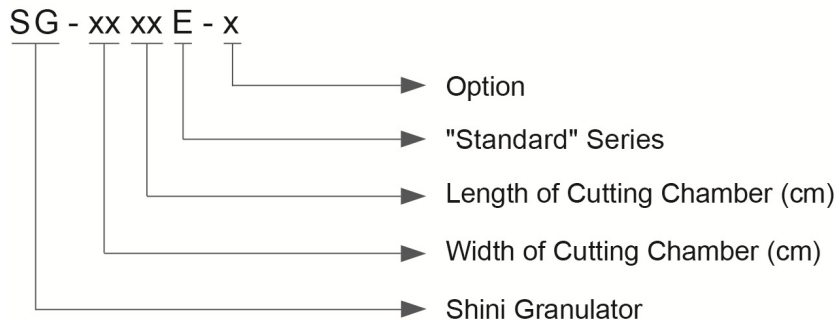

## 1.2 Feature

- SG-36E series adopts paddle blades design.
- Blades adopt imported steel to ensure high quality and high durability.
- Staggered blades design can decentralize working load when granulating to increase cutting efficiency.
- Staggered blades retainer is designed for quick blades changing without re-adjustment.
- Paddle blades with increased blade inclination design to ensure better cutting effect and lower noise.
- Equipped with motor overload relay and multiple safety devices.
- Easy access for convenient maintenance and cleaning.
- Compact in size for saving floor space and castors for easy movement.
- Standard structure design can reduce the cost of replacement parts.
- Standard with presetting knife jig, rotating blades can be adjusted in the fixture outside the machine instead of machine inside. It makes blades adjustment must easier.

All service work should be carried out by a person with technical training or corresponding professional experience. The manual contains instructions for both handling and servicing. Chapter 6, which contains service instructions intended for service engineers. Other chapters contain instructions for the daily operator.

Any modifications of the machine must be approved by SHINI in order to avoid personal injury and damage to machine. We shall not be liable for any damage caused by unauthorized change of the machine.



Our company provides excellent after-sales service. Should you have any problem during using the machine, please contact the company or the local vendor.

Headquarter and Taipei factory:

Tel: (886) 2 2680 9119

Shini Plastics Technologies (Dongguan), Inc:

Tel: (86) 769 8111 6600

Shini Plastics Technologies India Pvt.Ltd.:

Tel: (91) 250 3021 166

## 1.3 Technical Specifications

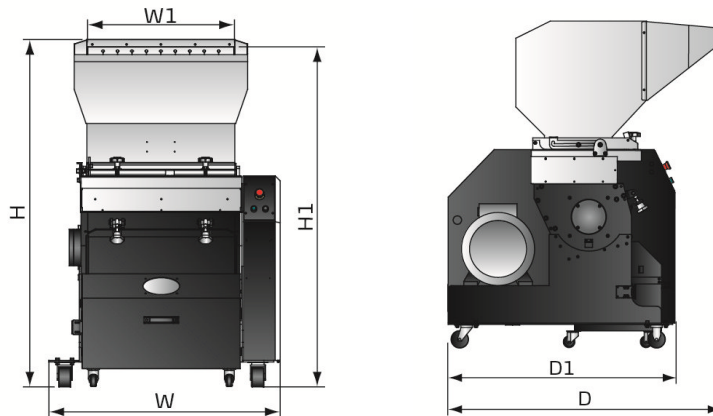

Picture 1-1: Dimensions

Chart 1-1: Technical Specifications

Model	SG-3650E	SG-3675E
Ver.	B	B
Motor Power (kW) (50 / 60Hz)	18.5 / 21	30 / 34.6
Rotor Speed (rpm) (50 / 60Hz)	540 / 620	540 / 620
Material of Blades	SKD11	SKD11
Number of Fixed Blades	2	4
Number of Rotating Blades	6	6
Cutting Chamber (mm)	360×500	360×750
Max. Output (kg/hr)	620	800
Noise Level dB(A)	110~115	110~115
Screen	✓ (Φ10mm)	
Dimensions		
H (mm)	1750	1750
H1 (mm)	1570	1570
W (mm)	1250	1500
W1 (mm)	500	750
D (mm)	1350	1450
D1 (mm)	1100	1400
Weight (kg)	1120	1360

Note: 1) " ✓ " stand for standard.

- 2) SKD11 is material code number of Japanese JIS standard.
- 3) Max. capacity of the machine is subject to diameter of screen mesh and composition of the material.
- 4) Noise level will vary with different materials and motor types.
- 5) For avoiding plastic to adhibit the blade, all materials should be crushed at normal temperature.
- 6) Power supply: 3Φ, 230 / 400 / 460 / 575VAC, 50 / 60Hz.

## 1.4 Safety Regulations

Follow the instructions in this manual to avoid personal injury and damage to machine components.

The following safety measures shall be followed when operating the granulator.

### 1.4.1 Safety Signs and Labels



Electrical installation must only be done by a competent electrician!



Before the granulator is opened for servicing and maintenance, always disconnect the power with both the main switch and the control switch on the granulator.



Never put any part of your body through the granulator openings, unless both the main switch and the control switch on the granulator are in "Off" position.



High voltage! Danger!

This sign is attached on the control box and the wiring box.



Be careful with the rotating knives, they are very sharp and can cause personal injury!



If the rotor must be turned manually-do this with great care!



The granulator should not be able to start before the hopper and screen bracket are properly closed.



Attention please!

Ear protection is used during granulating of plastic materials.



Never remove protective sponge or quick coupling clips adjacent to the outlet of storage bin.



Make sure the power has been cut off before opening the feed box.



Air inlet dust clean.



Attention!

No need for regular inspection because all the electrical parts in the control unit are fixed tightly!

When operate the granulator, please notice the following signs:

Maintenance Schedule	
Item	CT
Check the temperature controller.	Daily
Clean the filter.	Daily
Check whether overheat protection is normal.	Daily
Check whether dew-point is normal.	Daily
Check whether the contactor is normal.	Yearly
Check whether air pipe is shed, leaked and loose.	Weekly
Check whether cooling water circulation and Y-type filter are normal.	Daily
Check whether honey-comb rotor belt is damaged.	Semiyearly
Clean the cooler.	Semiyearly
PCB renewal.	Every 3 year exchange
No fuse breaker.	Every 3 year exchange

Note: Please refer to the Manual for detailed operations.  
YPS1115800100

Please according to schedule to make regular maintenance.

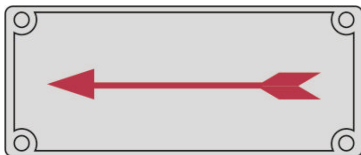

Please exchange the place of two of the electrical wires to solve this problem.

## 1.4.2 Transportation and Storage of the Machine

### Transportation

- 1) SG-36E series of granulators are packed in plywood cases with wooden pallet at the bottom, suitable for quick positioning by fork lift.
- 2) After unpacked, castors equipped on the machine can be used for ease of movement.
- 3) Do not rotate the machine and avoid collision with other objects during transportation to prevent improper functioning.
- 4) The structure of the machine is well-balanced, although it should also be handled with care when lifting the machine for fear of falling down.
- 5) The machine and its attached parts can be kept at a temperature from  $-25^{\circ}\text{C}$  to  $+55^{\circ}\text{C}$  for long distance transportation and for a short distance, it can be transported with temperature under  $+70^{\circ}\text{C}$ .

### Storage

- 1) SG-36E series should be stored indoors with temperature kept from  $5^{\circ}\text{C}$  to  $40^{\circ}\text{C}$  and humidity below 80%.
- 2) Disconnect all power supply and turn off main switch and exigency stop switch
- 3) Keep the whole machine, especially the electrical components away from water to avoid potential troubles caused by the water.
- 4) Use plastic film to cover the machine tightly to prevent the machine from dust and rains.

### Working environment

The machine should be operated:

- 1) Indoors in a dry environment with max. temperature  $+45^{\circ}\text{C}$  and humidity no more than 80%.

Do not use the machine:



- 1) If it is with a damaged cord.
- 2) On a wet floor or when it is exposed to rain to avoid electric shock.
- 3) If it has been dropped or damaged until it is checked or fixed by a

qualified serviceman.

- 4) This equipment works normally in the environment with altitude over 3000m.
- 5) At least 1m surrounding space is requested when this equipment is running. Keep this equipment away from flammable sources at least two meters.
- 6) In the work area of vibration and strong magnetic force

#### Rejected parts disposal

When the equipment has run out its life time and can not be used any more, unplug the power supply and dispose of it properly according to local code.



Fire hazard!

In case of fire, CO<sub>2</sub> dry powder fire extinguisher should be applied.



Flammable materials or materials which are contaminated by flammable substances/liquid may not be processed in the granulator. Serious risk of fire or explosion may cause personnel injury.



It is very important to tighten the screw as required torque.



When process item is longer than feed port, please cut long items into half until the length is shorter before processing.



Please don't put materials into the granulator if they are thinner than 2 mm and are soft and flexible, like rubber.

## 1.5 Exemption Clause

The following statements clarify the responsibilities and regulations born by any buyer or user who purchases products and accessories from Shini (including employees and agents).

Shini is exempted from liability for any costs, fees, claims and losses caused by reasons below:

1. Any careless or man-made installations, operation and maintenances upon machines without referring to the Manual prior to machine using.
2. Any incidents beyond human reasonable controls, which include man-made vicious or deliberate damages or abnormal power, and machine faults caused by irresistible natural disasters including fire, flood, storm and earthquake.
3. Any operational actions that are not authorized by Shini upon machine, including adding or replacing accessories, dismantling, delivering or repairing.
4. Employing consumables or oil media that are not appointed by Shini.

## 2. Structural Features and Working Principle

### 2.1 General Description

SG-36E granulator is designed for grinding plastic waste to granulate for recycling. The plastic waste should be free from metal parts and contamination before granulating. Mount magnet at the feed port to prevent metal scraps from getting into cutting chamber and brings damage to the blades. The granulator is controlled by start/stop and emergency stop button on control panel.

#### 2.1.1 Working Principle

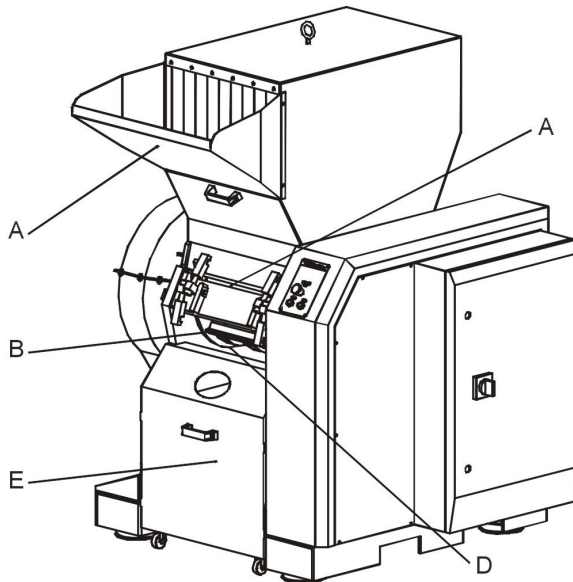

Parts name:

A. Feed port   B. Rotating blades   C. Fixed blades   D. Screen   E. Storage bin

Picture 2-1: Working Principle

The plastic waste is fed via feed port (A) and falls down into the cutting chamber, where rotating knives (B) cut the plastic waste against fixed knives (C) to granulate. A perforated screen (D) determines the size of the granulate. The screen is located in the lower section of the cutting chamber and can easily be changed to give the desired granulate size. The granulate passed the screen and falls down in the storage bin (E). After this, the granulate is ready for re-use in the production machine, or to be transported to a container for later use.



## 2.2 Safety System

The granulator has knives which rotate at high speed, therefore equip-ped with a safety system to avoid personal injury. The safety system must not be changed or modified in any circumstances. If the safety sy-stem of granulator is changed or modified, the machine can be danger-ous to use, presenting a serious rick of personal injury.

Allmaintenance to the safety system of the granulator must be carried out by personnel with the necessary knowledge.

### 2.2.1 Emergency Stop

The granulator has an emergency stop button on the control panel and the emergency stop is activated by pressing the button. Resetting is effected by turning the button in the direction of arrow (anti-clockwise).

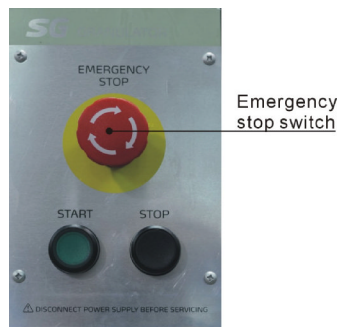

Picture 2-2: Emergency Stop Switch

### 2.2.2 Safety Switch

Equipped with safety switch which will cut down the main power of machine stop from running if the collecting bin or feeding hopper opened.

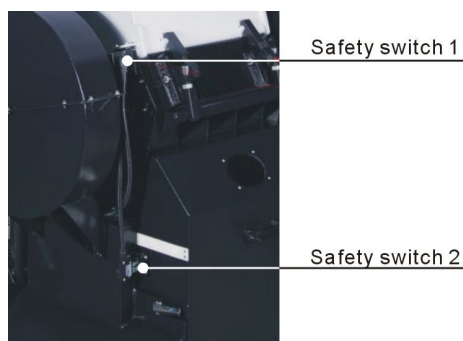

Picture 2-3: Safety Switch

### 2.2.3 Locking Screw

The star knobs which on the hopper and screen frame are very important components in the safety system of the granulator. When it unscrewed, the blades will be stopped. To avoid personal injuries.



Picture 2-4: Locking Screw

***NOTE: Do not change the screw length of locking screw.***

Before turning on the machine, the screws on feeding hopper and screen frame must be tightened to deadlock.

## 2.3 Optional Accessories

### 2.3.1 Special Screen

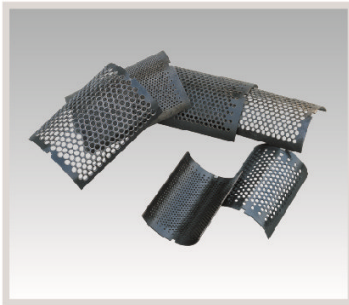

Optional screen mesh sizes includes  $\Phi 4$ ,  $\Phi 6$ ,  $\Phi 10$ ,  $\Phi 12$  (mm) which are applicable to SG-23E/30E series and  $\Phi 8$ ,  $\Phi 12$ ,  $\Phi 17$ ,  $\Phi 25$  (mm) which applicable to SG-36E series. All can be selected as per customer's requirement. Add "SS" at the model behind.

### 2.3.2 Full-receiver Alarm Device

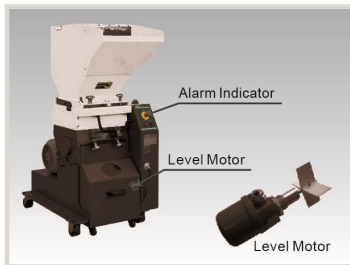

Full-receive alarm device can help to realize unmanned operation and no materials will be wasted. Whenever the regrind level reaches the motor position, the machine will be forced to stop and be cut off via it is sensor, thus stop the granulator and warn the user by sounding an alarm. Add "FAD" at the model behind.

### 2.3.3 Feed Hopper with Magnet

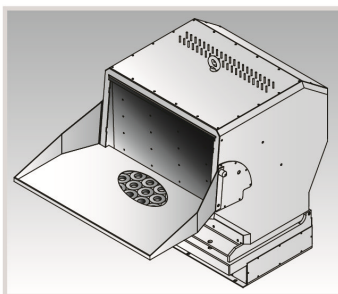

Feed hopper with magnet is used to take out metal craps and impurities in the material. Add "R" at the model behind.

### 2.3.4 Flywheel

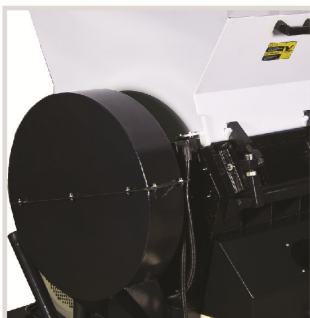

Increase inertia, thereby increasing the cutting ability. At the same time can result in a more balanced force and longer service life. It is an option for SG-36E series. Add "FW" at the model behind.

### 3. Installation and Debugging



Read through this chapter before installation.



Install as following orders to avoid any accident!



Be careful! Not to be cut by the sharp blade.



Power connection must be done by the professional electrician to avoid electrical shock.



Caution!

cutters should be laid level, prevent the cutters from self-rotating when do installation, don't let your hands be near to the cutters to avoid personal injury.



Notice!

Do not install the cutters by working together, because this could bring personal injury. Use a thick wood block to stop the rotating knives from turning.



Notice!

The blades are very sharp, so use protective gloves to avoid being cut.



Notice!

Please use new screws and gaskets when installing cutters.



The power connection of the granulator should be carried out by professional electrician so to avoid electrical shock!

### 3.1 Installation Notice

- 1) Make sure voltage and frequency of the power source comply with those indicated on the manufacture's plate, which is attached to the machine.
- 2) Power cable and earth connections should conform with local regulations.
- 3) Use independent power cable and ON / OFF switch. The cable's dia. Should not smaller than those applied in the control box.
- 4) The power cable connection terminals should be tightened securely.
- 5) The machine requires a 3-phase 4-wire power source, connect the power lead (L1, L2, L3) to the live wires, and the earth (PE) to the ground.
- 6) Power supply requirements:  
Main power voltage: +/- 5%  
Main power frequency: +/- 2%
- 7) Power connection refers to the circuit diagram of each model.

Make at least 1 meter clearance around the machine to facilitate repair and maintenance.

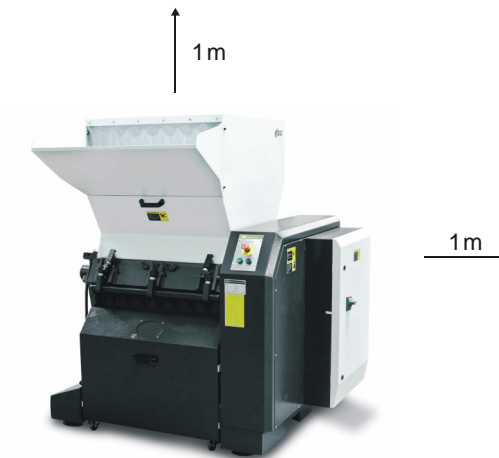

Picture 3-1: Installation Space

## 3.2 Installation Place



Make enough installation space to facilitate the repair and maintenance. Check and make sure the installation ground is level, and there is enough intensity when it is running.

Use spirit level to adjust the cutting chamber to the level position.

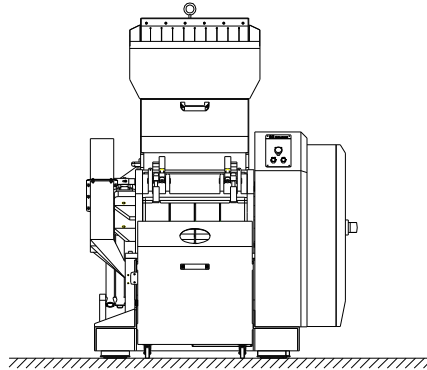

Picture 3-2: Installation Place

## 3.3 Installation of Blade Rest and Bearing

- 1) Heat the bearing and lay it to be entrapped into the blade rest. Use 120 degrees transfer oil to heat it up for 5 minutes.
- 2) Fix the low half part of bearing base into both right and left sides of table-board, match the positions of the hole and lock them tightly.
- 3) Put the blade rest in the cutting chamber and make both ends of its bearing to match with the grooves.

***Note: Add some lubricating oil in both bearing and bearing block. Aluminous circlip should be laid between the left bearing and its bearing block.***

- 4) Install the baffle ring and bearing cap. Then, lock it up with screws.

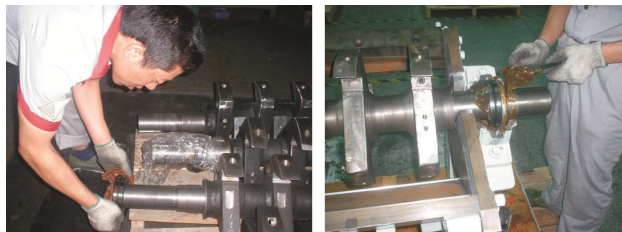

Picture 3-3: Installation of Blade Rest and Bearing

### 3.4 Installation of Belt Pulley and Motor

- 1) Interpose the key to the key groove and then install the driven wheel.

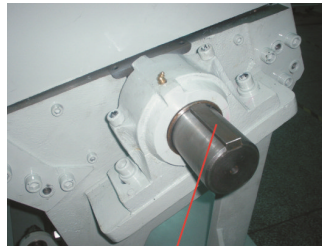

Key

Picture 3-4: Installation of Belt Pulley and Motor 1

- 2) Lay lockup ring in the hole of the driven wheel and make both positions of the hole to match each other then screw the hexagon socket cap screw.
- 3) Adjust the balance of the driven wheel with dial gauge. Stick the dial gauge to the driven wheel and rotate the driven wheel to see whether the value of the indicator drops within 0~0.1 mm.



Picture 3-5: Installation of Belt Pulley and Motor 2

- 4) After balance, screw tightly the 8 hexagon socket cap screws.
- 5) Install the driving wheel in the bearing of the motor and screw the 6 hexagon socket cap screws with the specificity of 10mmx35.
- 6) Lay the motor on the fixing plate to adjust and screw tightly the 4 fixing screws. Push forward to shorten the space between the driving wheel and the driven wheel.



Picture 3-6: Installation of Belt Pulley and Motor 3

- 7) Adjust the balance of the driving wheel and driven wheel: place spirit level between the driving wheel and the driven wheel to observe whether the mercury column is in the middle. If not, adjust the driving wheel (note: NOT the driven wheel) to make the driven wheel and driving wheel in balance.

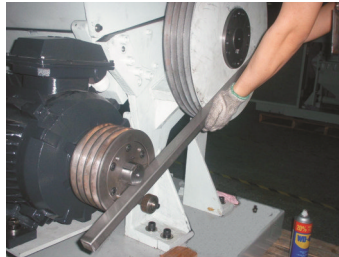

Picture 3-7: Installation of Belt Pulley and Motor 4

- 8) Install the belt, push the motor rightward and screw tightly the position adjusting bolt to make the 4 belts be stressed by equal forces. Tighten the belts and screw down the position adjusting bolt.

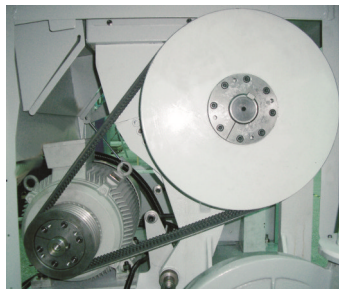

Picture 3-8: Installation of Belt Pulley and Motor 5



### 3.5 Installation of Fixed Blades and Rotating Blades



#### Notice!

The blades are very sharp, so use protective gloves at the installation to avoid being cut.

#### Installation steps:

- 1) Lay the rotating blades into the knife groove in the knife rest to make them match and then cover the pressing block. Finally, screw the screws down to make the blade not sway.
- 2) Install the front and back pressing blocks and the fixed blades on the front and back boxes. Screw down the screws until the blade cannot sway anymore.
- 3) Measure the space between the fixed blade and the rotating blade using a steel rule. The normal space ranges is 0.4~0.5 mm. If the space is not in this range It can reach this range through adjusting the fixed blade and rotating blade. Screw down the fixing screws between the fixed blade and the rotating blade.

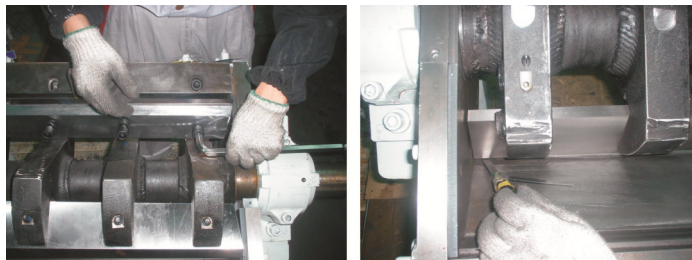

Picture 3-9: Installation of Fixed Blades and Rotating Blades

**Caution: Fixed screws for the blades must all be tightened to avoid cutting and doing arm to machine.**

**Caution: The space between the fixed blade and the rotating blade cannot be too narrow to avoid damaging the cutting tool.**

### 3.6 Installation of Regrind Storage Bin, Screen and Screen Bracket

- 1) Put the screen into the screen bracket and screw the screen down with 2 screws.
- 2) Lift up the screen bracket and make its iron rod slide along with both sideboards into the fixing grooves.
- 3) Lift up the screen bracket again and lock it closely with the very front fixing pothook.

**Note: Make sure to fasten the screw. Otherwise, it will result in screen deformation, and screw break.**

- 4) Put the storage bin underside of the grinding room.
- 5) Fixed the safely switch.

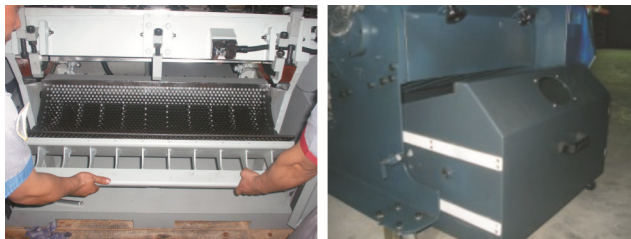

Picture 3-10: Installation of Regrind Storage Bin, Screen and Screen Bracket

### 3.7 Installation of Screen, Screen Frame and Storage Bin

- 1) Hoist the feed box to put it on the cutting chamber carefully to match.
- 2) Mount both side location pin and lockup with lockup screw.



Picture 3-11: Installation of Screen, Screen Frame and Storage Bin 1

- 3) Lockup the two pothooks in the front of the feed box.

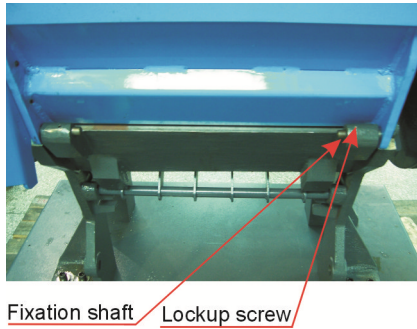

Picture 3-12: Installation of Screen, Screen Frame and Storage Bin 2

- 4) Install pneumatic spring fixing block to the lower left side of the.

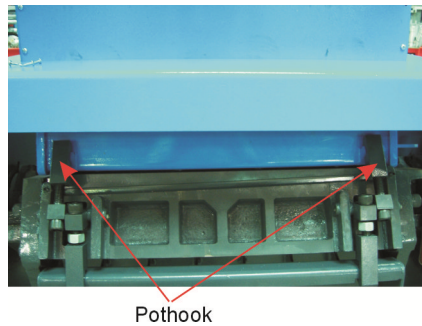

Picture 3-13: Installation of Screen, Screen Frame and Storage Bin 3

- 5) Install pneumatic spring and make its lower end link to the fixing pole of the machine base.



Picture 3-14: Installation of Screen, Screen Frame and Storage Bin 4

## 4. Operation Guide



Wear earplugs during operating to avoid personal injury!



Wear gloves during operating to avoid personal injury!



Wear goggles during operating to avoid personal injury!



Because the blades and rotor may be loosen, check the following items before operating:

- 1) If the blades has any damage.
- 2) If the surface of the rotor is loosen.
- 3) Push or pull the rotor and blades to see if there is any loose connection.

If any of the above situation is found, please contact local representative or SHINI company for help.

### 4.1 Prestart Check

- 1) The unpainted parts of the machine are protected with oil prior to delivery and transport. Clean the granulator from rust protection agent before it is used.
  - a) Use dishcloth to clean firstly.
  - b) Then use dishcloth with water to clean.
- 2) Check the distance of the knife(0.40~0.50mm) and tightening torque (Twisting force 90Nm).

#### 4.1.1 Two Hours After First Start

Check the knife distance again, including rotating blades and fixed blades. Check the screws on them to see if there is any loosen one.

### 4.2 Power Connection

- 1) Connect the granulator to the power.
- 2) Switch on the main power and circuit breaker.
- 3) Check that the emergency stop is not activated.

- 4) Check that the star knobs on the hopper and screen frame locks are fully tightened.
- 5) Start the machine.
- 6) Check that the granulator motor rotates in the direction indicated by the arrow on the cutter pulley.
- 7) If any direction of rotation should be incorrect:
  - a) Stop.
  - b) Switch off the main power.
  - c) Change two income wires of the motor.
  - d) Restart and recheck.

### 4.3 Start / Stop of the Machine

SG-36E series of granulator use the start and stop button located on the control panel for controlling.

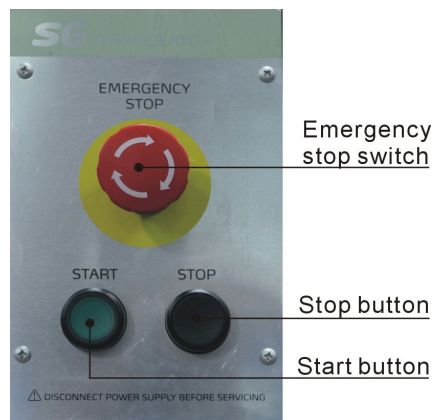

Picture 4-1: Start / Stop of the Machine

***Note: Never stop the granulator before any material in the hopper or cutter chamber is completely granulated.***

***Residual material will clog the rotor in the granulator during restart.***

***The motor will be overloaded and the overloading protection will trigger.***

## 4.4 Open the Feed Box

Turn off the power before opening the feed box and screen frame of the SG-36E series of granulator.



Becareful! Since the blades are very sharp and can cause personal injuries.



Clean the inside surface of the feed box before closing it.

- 1) Check that the feed-in case is empty, and then start the machine.
- 2) Loosen the lock screw of the feed box.
- 3) Open the feed box backwardly.
- 4) Use supporting plate to hold the feed box and keep it from falling down.



Note!

The feed box is held by pneumatic spring, therefore it can not fall down.

## 5. Trouble Shooting

### 5.1 Granulator Can Not Work

- 1) Check if the emergency stop has been reset or not. If not, rotate the button anti-clockwise to reset it.
- 2) Check if the safety switch between feed box and storage box is completely closed. If not, machine can not be started.
- 3) The overload protector in the electrical control box will work if the motor overloads. Test white key (A) turn left, press the “Reset” button (B) to reset it. Before it starts again, check whether there is any powder left in the granulator.
- 4) If the feeding blower does not run, the granulator can run neither. Check the motor protector in the electric control box. If the protector is closed, the switch will be at “0” position, reset it to “1” position. Check if there’s no leftover, then re-start the machine. Test the white key(A) turn left, press” Reset” key (B) to reset it.
- 5) Check the clearance between the blades . The stop will happen or the motor overload protector will work if the blade is very blunt or the space between blades is not correct. Protector will be tripped if motor is overload. Blades should be checked, replaced or adjusted between the blades.
- 6) The contactor is burnt down or the control circuit is break off.



## 6. Maintenance and Repair

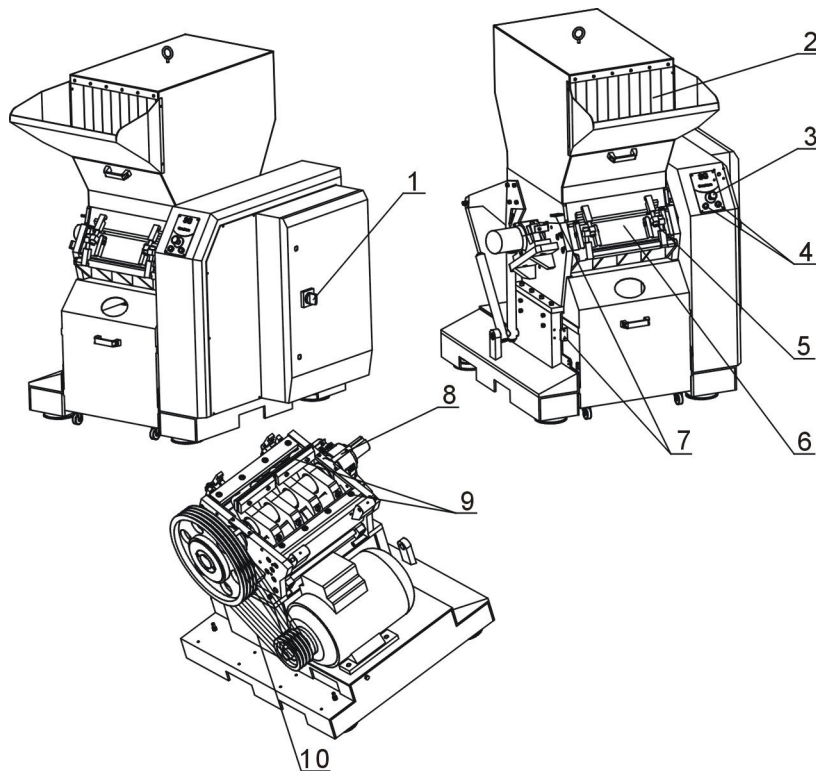

1. Check the main power switch (daily).
2. Check whether the fender trim strip is damaged (daily).
3. Check whether the emergency stop function works normally (daily).
4. Check whether the run/stop button works normally (daily).
5. Check whether the screw between feed box and screen bracket is damaged (daily);
6. Check whether there is metal impurities in the cutting chamber before operation (daily);
7. Check whether all the safety switches work normally (daily).
8. Regularly check and grease the bearing (monthly).
9. Check whether the blades and the screws is fasten up and the wear patterns of the blade and screen (monthly).
10. Check whether the belt is damaged (monthly) and belt tension (semi-yearly or working for 20~30 hours at full load).



## 6.1 Repair

All the repair work should be done by professionals in order to prevent personal injuries and damage of the machine.

### 6.1.1 Changing the Blade



Be careful when holding the blades, they are sharp and can cause personal injury. Use protective gloves!



Do not install the cutters by working together, because this could bring personal injury. Use a thick wood block to stop the rotating knives from turning.



Every time the blades are changed, the blade fastening hexagon socket cap screws (specification=M16 × 70mm, strength 12.9 and hardness HRC41) must be replaced by new ones.

#### 1) Remove the Fixed Blades

**Note: In order to avoid blades rotating by itself, please must take one thick wooden block to seize the rotor to prevent its rotating.**

1. Remove the screw and washer.
2. Take the rotated blades.
3. Clean the mounting interface of blades.

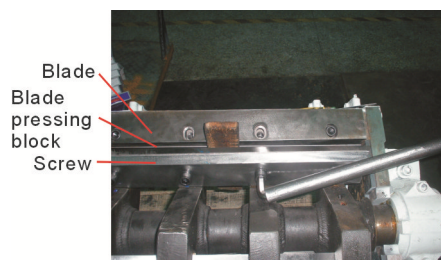

Picture 6-1: Remove the Fixed Blades

#### 2) Remove the fixed blades

1. Revolve the screw of the front fixed blades.
2. Loosen and remove the hexagon socket cap screw.

3. Remove pressing block and blades , clean the blades rest.
4. Loosen and remove the screws of the back blades.
5. Loosen and remove the hexagon socket cap screw, remove the pressing block and the blades ,clean the supporter box.

### 3) Mounting blades

Clean the fixed blades and rotating blades carefully before mounting the blades.

**Note: Screw and washer must use new parts when changing blades each time. Firstly mounting the fixed rear blades, then install front fixed blades, finally install rotating blades. First of all, install the fixed blade.**

A: The installation steps with presetting knife jig:

- 1) All blades, including rotating blade and fixed blade, could be adjusted inside the presetting knife jig outside the machine. Put the blade into the presetting knife jig. Regulate the adjusting screw till it touches the presetting knife jig.

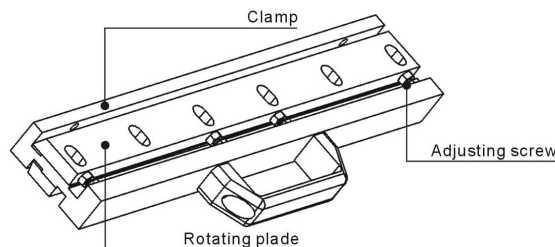

Picture 6-2: Blades Installation Adjusting

- 2) After the rotating and fixed blade adjusted well on the presetting knife jig, put the rotating blade inside the groove of the milled blade rest. Aim the holes on the blade rest, put down the pressing plate and fix the screws till the blade without any shaking (in order to adjust the clearance between the rotating and fixed blade).
- 3) Mount front / back pressing block of the rotating and fixed blade on front /back block, fasten the screw till the blade without any shaking.
- 4) Use the feeler gauge to check the clearance between rotating and fixed blade, the distance is 0.2~0.3mm; Adjust the rotating and fixed blade if it is

not within this distance. At last, lock the fixing screw of rotating and fixed blade with torque spanner, for the torque please refer to Table 6-1.

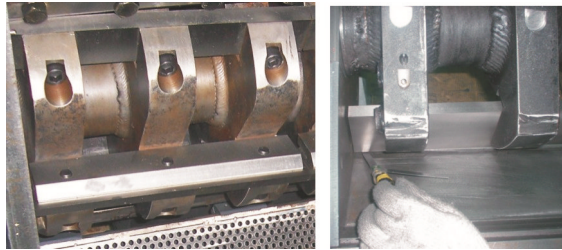

Picture 6-3: Installation of Rotating and Fixed Blade

B: Without presetting knife jig:

- 1) When presetting knife jig is not adopted, firstly adjust the length of one adjusting screw on rotating blade as its total width with blade to  $90\pm 0.07\text{mm}$ . Then adjust another screw length to the same value, at last lock the nuts and screws.
- 2) Same as the installation with presetting knife jig.



NOTE!

In order to avoid human injury and machine damage, it must lock up the blade screw tightly.



NOTE!

The blade clearance can't be too close to avoid blade damage!



NOTE!

Every time to replace the cutters, the blade, pressing block, screw, blade rest and main shaft should be inspected carefully, to check if there is any damage.



NOTE!

When replacing the cutter, check whether the blade, pressing block, screw, blade rest and main shaft are damaged.

Chart 6-1: Attached form, Cutters and other Fixing Screw Torque

Screw Type	Screw Dimension	Stretching Force Fv(N)			Tightening Torque Ma(N.M)		
		8.8 Degree	10.9 Degree	12.9 Degree	8.8 Degree	10.9 Degree	12.9 Degree
Coarse thread	M4	3900	5750	6700	3.0	4.4	5.1
	M5	6400	9400	11000	5.9	8.7	10
	M6	9000	1320	15500	10	16	18
	M8	16500	24300	28400	25	36	43
	M10	26300	38700	45200	49	72	84
	M12	38400	56500	66000	86	126	145
	M14	62500	77500	90500	135	200	236
	M16	72500	10700	12500	210	310	365
	M18	91000	129000	152000	300	430	600
	M20	117000	166000	195000	425	610	710
	M22	146000	208000	244000	580	820	960
	M24	168000	240000	281000	730	1050	1220
	M27	222000	316000	369000	1100	1550	1800
	M30	269000	384000	449000	1450	2100	2450
Fine thread	M8×1	18100	26600	31200	27	39	46
	M10×1.25	28300	41600	48700	52	76	90
	M12×1.25	43300	63500	74600	93	135	160
	M12×1.5	40800	60000	70000	89	130	155
	M14×1.5	58600	86000	100000	145	215	255
	M16×1.5	79500	116000	136000	226	330	390
	M18×1.5	108000	152000	177000	340	485	570
	M20×1.5	134000	191000	224000	475	680	790
	M22×1.5	166000	236000	276000	630	900	1050
	M24×2	189000	270000	316000	800	1150	1350
	M27×2	246000	350000	409000	1150	1650	1950
	M30×2	309000	440000	515000	1650	2350	2750

## 6.2 Transmission

### 6.2.1 Daily Maintenance of V-belt

The granulator is driven by four V-belts.

1) Check the V-belt.

After 20 to 30 hours operation under full load, check V-belt tension and its working condition. Check if the belt is wearing out every month.

2) Check V-belt tension every 6 months.

Take down the top cover on the right side of control box, pull around the belt to see if there is any damage.

***Note: Do not put your hands between the belt and wheel, or hands crushing may occur. Check and adjust belt tension if necessary.***

Check the belt tension, (it is needed to adjust if necessary). Belt tension can be detected by adding one force on the belt, that is to say, adding this force on the belt between the driven pulley and driving pulley and simultaneously measure the curve degree of belt ( this curve degree standard value is related with the motor power and frequency, for further detail information please following table as below.

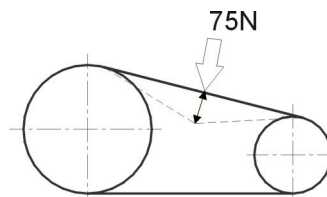

Picture 6-4: Daily Maintenance of V-belt

<b>Motor 50Hz</b>	<b>18.5/22kW</b>	<b>30/37kW</b>	<b>45-55kW</b>
<b>New belt</b>	15mm	14mm	15mm
<b>Used belt (after be used 6 months)</b>	19mm	19mm	19mm
<b>Motor 60Hz</b>	18.5/22kW	30/37kW	45-55kW
<b>New belt</b>	18mm	17mm	16mm
<b>Used belt (after be used 6 months)</b>	23mm	23mm	20mm

## 6.2.2 Adjust the V-belt

- 1) Take down the side plate on the control box that is located on the right side of the machine.
- 2) Take out the storage bin; loose the position adjusting screws of the motor.
- 3) The tension of the belt could be altered by adjusting the distance between motor and driving wheel. Tighten the screws after you finished the adjustment.
- 4) Lockup the screw as figure 6-3 shows
- 5) Re-check belt tension after 20 to 30 hours operation under full load.



Picture 6-5: Adjust the V-belt

## 6.3 Lubrication

### 6.3.1 Lubricating Oils

Xin Chang Long: FX-00

FX-000

Bp: BP Grease LGEP 2

ESSO: Beacon Ep2, Beacon EP2

Mobil: Mobilux EP2

Shell: Shell Alvania EP2

Texaco: Multifak Ep2, Novotex Grease EP2

### 6.3.2 Lubricating Method

Inject lubricating oil via throat with an oil greaser. (It had better add lubricant once for three months)

If the granulator has not been used for a long time, please grease anti-rust oil in blade rest, fixed blade, rotating blade, cutting chamber and screws to avoid dust.

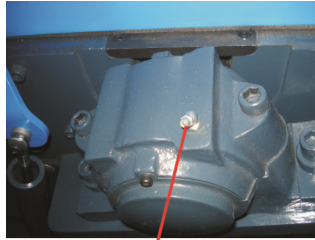

Bearing cover

Picture 6-6: Bearing Cover

## 6.4 Maintenance

### 6.4.1 Daily Maintenance

- 1) Check if the plastic shutter at the intake of feeding hopper is broken or not. If there is any damage, replace it. Or damaged parts may fall into cutting chamber and cause pollution. It also makes the material easy to fall out.
- 2) Check if the emergency stop is working properly. Stop the machine by using this button to check its function. Turn round as the arrow shows on this button to reset.
- 3) Check if the locking screw fasten which is used to fix the material inlet bin and screen bracket. These screw are parts of safety system for all machine and their length was designed in advance, which can stop machine if these screw loosen. Broken screw must be changed with new one.



Lock screw

Picture 6-7: Lock Screw

### 6.4.2 Weekly Checking

- 1) Check if the electric wires are worn out or damaged. Replace the broken wires.
- 2) Check the function of safety switch.
- 3) Check the safety switch of feed box and storage bin.

### 6.4.3 Monthly Checking

- 1) Check if the V belt is damaged or not.
- 2) Check belt tension every 6 months, see details at chapter 6.2 "Transmission".

## 6.5 Cleaning



### Note!

Make sure the main power is turned off before cleaning. When you open the feeding hopper, be careful not to touch the blades. Sharp blades may cause personal injuries.

- 1) Before turning off the machine, please check if the material inlet bin and cutting chamber is empty.
- 2) Clean the exterior surface of the feed box.
- 3) Turn off the main power switch.
- 4) Clean the baffle plate of the feed box with a dust separator.
- 5) Loosen the lock screw.
- 6) Loosen the lockup clip and open the feed box backwardly.

**Note: The feed box is held by pneumatic spring, therefore it can not fall down.**

- 7) Clean the interior surface of the feed box.
- 8) Remove the regrind storage bin.
- 9) Loosen the lock wiring in the screen bracket and remove the screen bracket.

**Note: Lift the screen with hands so it would not fall down.**

- 10) Take out the screen.
- 11) Catching to the screen and take it out outwardly.
- 12) Clean the regrind storage bin, screen bracket and the screen.
- 13) Clean both surface of the cutting chamber.
- 14) Clean the wheels with bright dust-precipitator.

### Reinstall after cleaning

- 1) Install the screen bracket.
- 2) Lift the handle of the screen bracket and push into screen bracket.



- 3) Fold down the screen bracket and install the screen to ensure to install the screen accurately via checking whether aligning the bulge and the holler of the bracket.
- 4) Taking h of the front pant of screen bracket edge and push the front of the screen bracket in the direction of cutting chamber. Fix the screen bracket via connect the pothook to the screen bracket.
- 5) Install the regrind storage bin.
- 6) Close the feed box.
- 7) Install the rubber shutter of the feed box.
- 8) Tighten the locking buckle.
- 9) Check whether the feed box is exhausted.
- 10) Turning on the main power switch.
- 11) Turn on the machine.

## 6.6 Maintenance Schedule

### 6.6.1 About the Machine

Model \_\_\_\_\_ SN \_\_\_\_\_ Manufacture date \_\_\_\_\_

Voltage \_\_\_\_\_  $\Phi$  \_\_\_\_\_ V Frequency \_\_\_\_\_ Hz Power \_\_\_\_\_ kW

### 6.6.2 Check After Installation

- Check the gap between fixed blade and rotating blade. (0.4~0.5mm).
- Check the rotating balance of the belt wheel.

#### Electrical Installation

- Voltage: \_\_\_\_\_ V \_\_\_\_\_ Hz
- Specs of the fuse: 1 Phase \_\_\_\_\_ A 3 Phase \_\_\_\_\_ A
- Check phase sequence of the power supply.
- Check the rotating direction of the conveying blower.

### 6.6.3 Daily Check

- Check main power switch.
- Check emergency stop button.
- Check start / stop button.
- Check material check plate (strip) is perfect or not.
- Check whether emergency stop and safety switch works normally.
- Clean screen and feeding hooper.
- Check whether start, stop and power switches are normal.

### 6.6.4 Weekly Check

- Check all the electrical cables.
- Check if there are loose connections of electrical components.
- Check blade condition.
- Check whether set screws in fixed and rotate blades are under looseness.
- Check if there is abnormal noise, vibration and heat in reduction gear.
- Check the cracking window

### 6.6.5 Monthly Check

- Check the status of the belt.
- Check the overload protection function of the motor.

- Check motor reversed running function.
- Check the tightness of the blades.
- Check whether clamp ring of pulley is fastened.
- Check belt tension.

#### 6.6.6 Check Half-yearly or Every 1000 Running Hours

- Check or replace lubrication for gear motor.
- Check lubrication of bearing.
- Check coupling.
- Evaluation of the machine condition.

#### 6.6.7 3 year Checking

- PC board renewal.
- No fuse breaker renewal.