

机型版本 Ver E		制图		版号 M		标题 SG-4360(H) 主电路图		图号 SG-4360(H)-CE-400V-M-1		比例 第 1 张	
		设计		核准						标准 CE 共 12 张	
		校对		日期 20220805		SHINI 信易電熱機械股份有限公司 Shini Plastics Technologies, Inc.		机器电压 3φ400V		机器频率 50Hz	
标记	更改前	更改后	更改人	日期	审核	日期					

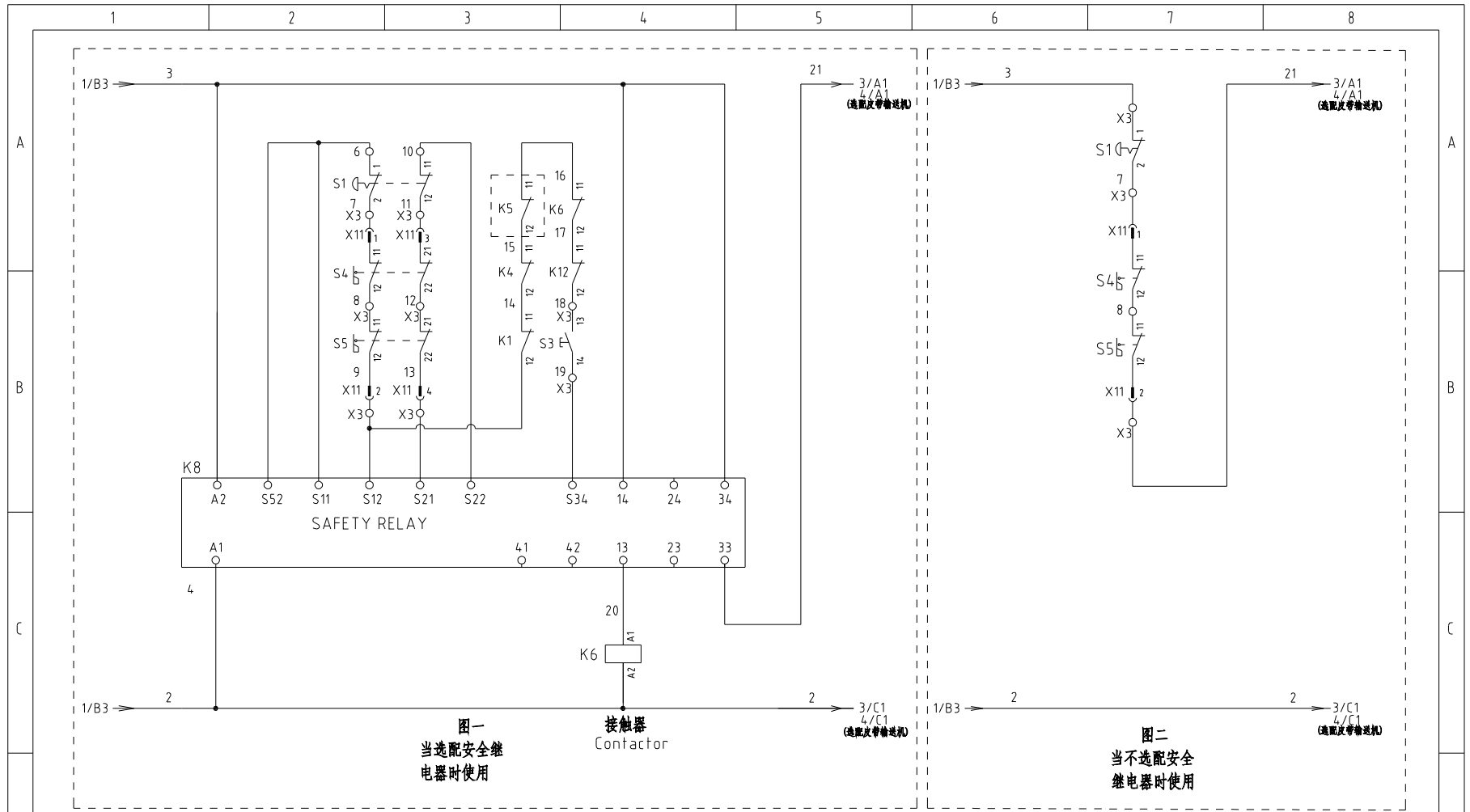

机型版本 Ver.E

制图	版号	M	标题	SG-4360(H)	图号	SG-4360(H)-CE-400V-M-2	比例	第 2 张
设计	核准		控制电路图一				标准	CE 共 12 张
校对	核准						机器电压	3φ400V
标记	更改前	更改后	更改人	日期	20220805		机器频率	50Hz



信易電熱機械股份有限公司
Shini Plastics Technologies, Inc.

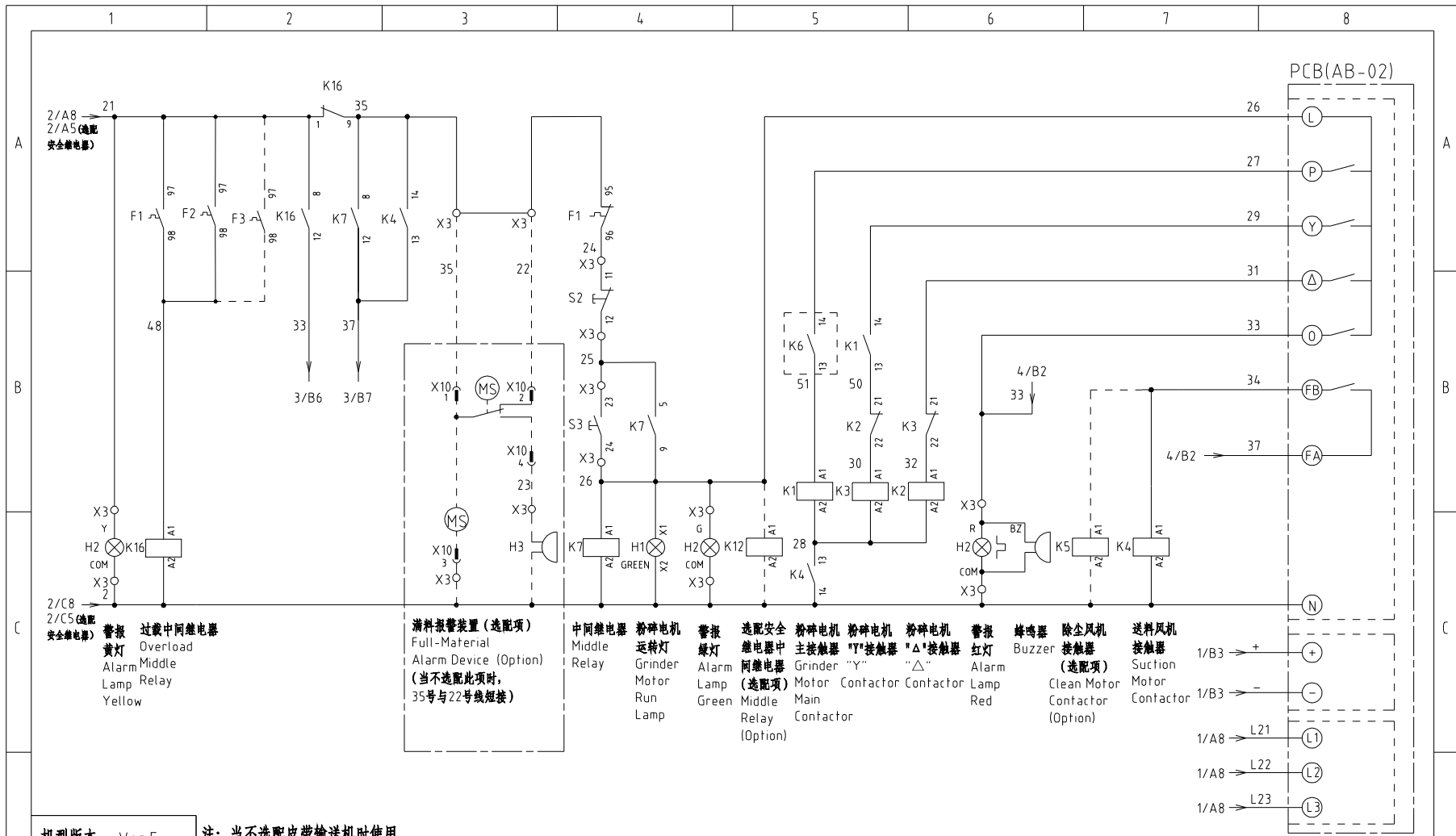

2/C8
2/C5 (选配
安全继电器)
警报 过载中间继电器
黄灯 Overload
Alarm Middle
Lamp Relay
Yellow

满料报警装置 (选选项)
Full-Material
Alarm Device (Option)
(当不选配此项时,
35号与22号线短接)

中间继电器 粉碎机
Middle Relay Grinder
Run Lamp
Lamp

警报 选配安全
继电器中
间继电器
警报
红灯
Middle Main
Relay Contactor
(Option)

粉碎机 粉碎机 粉碎机
Grinder "Y" "△"
Contactor Contactor
Contactor

警报 蜂鸣器 除尘风机
Alarm Buzzer 接触器
Red (选选项)
Clean Motor
Contactor
(Option)

送料风机
Suction
Motor
Contactor

1/B3 → +
1/B3 → -
1/A8 → L21
1/A8 → L22
1/A8 → L23

机型版本 Ver.E 注: 当不选配皮带输送机时使用。

制图	版号	M	标题	SG-4360(H) 控制电路图二	图号	SG-4360(H)-CE-400V-M-3	比例	第 3 张
设计	核准		标准	CE	机器电压	3φ400V	共 12 张	
校对	日期	20220805	SHINI	信易電熱機械股份有限公司 Shini Plastics Technologies, Inc.	机器频率	50Hz		
标记	更改前	更改后	更改人	日期				



信易電熱機械股份有限公司
Shini Plastics Technologies, Inc.

比例 第 3 张
标准 CE 共 12 张
机器电压 3φ400V
机器频率 50Hz

选配皮带输送机控制触点接线示意图

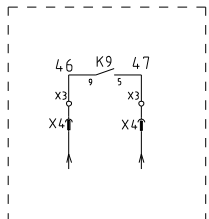

X4金属接头接线示意图
接皮带输送机
(选配项)

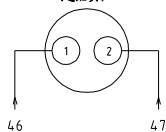

X10金属接头接线示意图
接满料报警装置
(选配项)

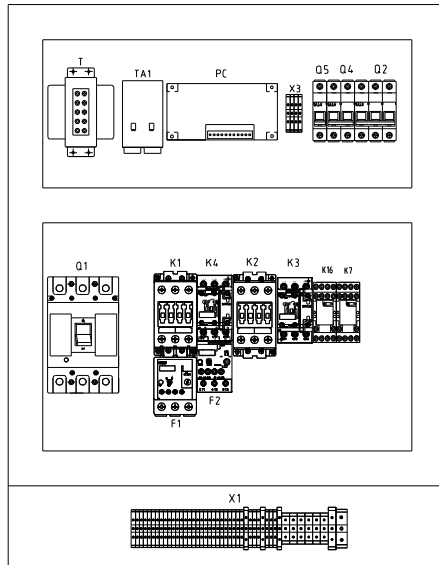
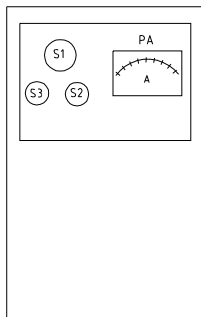
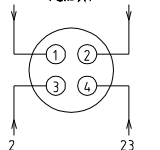

标准机型布局图

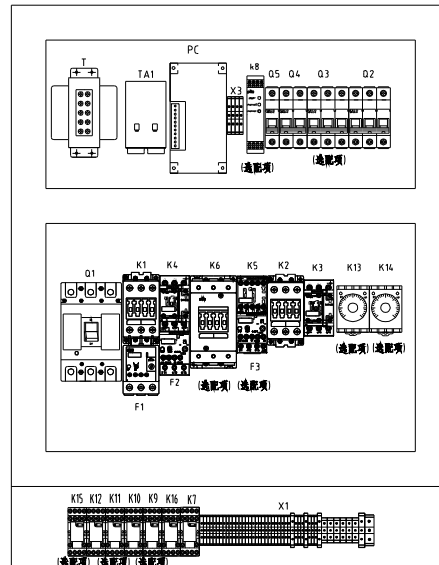

选配机型布局图

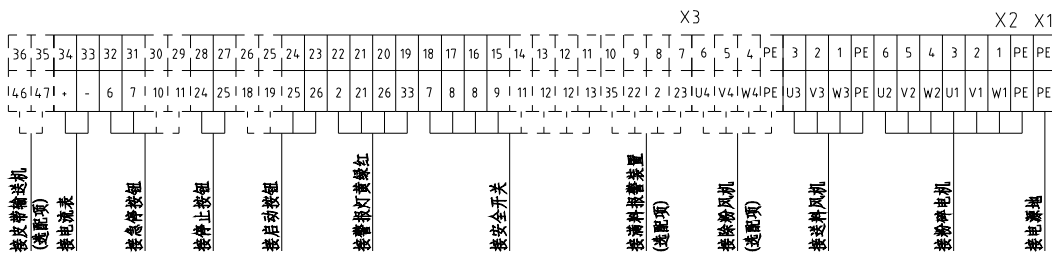

X11: 16P重载接插件

①	7	⑨
②	9	⑩
③	11	⑪
④	13	⑫
⑤		⑬
⑥		⑭
⑦		⑮
⑧		⑯

注: 当不选配安全继电器时将9号端子改为21号, 11号端子和13号端子不用接

机型版本 Ver.E 注: 当不选配安全继电器时将6号端子改为3号, 9号端子改为21号。

制图	版号	M	标题	SG-4360(H) 电气元件布置图	图号	SG-4360(H)-CE-400V-M-6	比例	第 6 张
设计	核准						标准	CE 共 12 张
校对	日期	20220805					机器电压	3φ400V
标记	更改前	更改后	更改人	日期			机器频率	50Hz



1		2		3		4		5		6		7		8		
序号/NO	符号/Symbol	名称/Name		制造商/Manufacturer		型号/Type		规格/Specification		数量/Number		物料编号/Material number		备注/Remark		
A	1	Q1	断路器/Circuit breaker		TECO		B0100EB3100 3P		100A		1		YE40100300400			
	2		断路器外部操作把手/External operating handle		TECO		1A-CS1-C-D1 (B0100EB)		----		1		YE90111100100			
	3	Q2	断路器/Circuit-breaker		TECO		BM-63C/3P		10A		1		YE40301003000			
	4	Q2	断路器/Circuit-breaker		TECO		BM-63C/3P		32A		1		YE40303203000		(6)	
	5	Q3	断路器/Circuit-breaker		TECO		BM-63C/3P		6A		1		YE40300603000		(2)	
	6	Q4	断路器/Circuit-breaker		TECO		BM-63C/2003S 2P		3A		1		YE40200203000			
	7	Q5	断路器/Circuit-breaker		TECO		BM-63C/1010S 1P		10A		1		YE40101000100			
B	8	K1,K2	接触器/Contactor		SIEMENS		3RT5035-1AC20		40A 24VAC 50/60Hz		2		YE00503502600			
	9		辅助触点/Auxiliary Contactor		SIEMENS		3RH5921-1CA01		1NC		1		YE00592110100		(4)	
	10		辅助触点/Auxiliary Contactor		SIEMENS		3RH5921-1CA01		1NC		1		YE00592110100			
	11		辅助触点/Auxiliary Contactor		SIEMENS		3RH5921-1CA10		1NO		1		YE00592110000		(5)	
	12		辅助触点/Auxiliary Contactor		SIEMENS		3RH5921-1CA10		1NO		1		YE00592110000			
	13	K3	接触器/Contactor		SIEMENS		3RT6028-1AC20		38A 24VAC 50/60Hz		1		YE00602802600			
	14	K4	接触器/Contactor		SIEMENS		3RT6016-1AB01		9A 24VAC 50/60Hz		1		YE00601602500			
C	15	K4	接触器/Contactor		SIEMENS		3RT6026-1AC20		25A 24VAC 50/60Hz		1		YE00602602600		(6)	
	16		辅助触点/Auxiliary Contactor		SIEMENS		3RH6911-1HA11		1NC+1NO		1		YE00691100100			
	17	K5	接触器/Contactor		SIEMENS		3RT6016-1AB02		9A 24VAC 50/60Hz		1		YE00601602600		(2)	
	18	K6	接触器/Contactor		SIEMENS		3RT5045-1AC20		80A 24VAC 50/60Hz		1		YE00504502600		(4)	
	19		辅助触点/Auxiliary Contactor		SIEMENS		3RH5921-1CA01		1NC		1		YE00592110100		(4)	
	20		辅助触点/Subsidiary Contactor		SIEMENS		3RH5921-1CA10		1NO		1		YE00592110000		(4)	
	21	K7	中间继电器/Middle relay		Honeywell		GR-2C-AC24V		24VAC		1		YE03022400300			
D	22	K7	中间继电器/Middle relay		Honeywell		GR-4C-AC24V		24VAC		1		YE03042400300		(5)	
	23	K8	安全继电器/Safety relay		PILZ		PNOZ×2.8P		24V AC/DC		1		YE04023000000		(4)	
	24	T	互感器/Transformer		JIUXIN		IN=400V/415V OUT=24V		180VA		1		YE70040006700			
	25	T	互感器/Transformer		----		IN=400V/415V OUT=24V		350VA		1		YE70040009900		(4)	
	机型版本 Ver.E		注: (1)表示非电控箱内材料; (2)表示除尘马达选配件; (3)表示满料报警装置选配件; (4)表示安全继电器选配件; (5)表示皮带输送机选配件; (6)表示加大风机功率选配项。													
					制图		版本号 M		标题 SG-4360		图号		比例		第 7 张	
					设计		核准		电气元件明细一		SG-4360(H)-CE-400V-M-7		标准 CE		共 12 张	
				校对				 信易電熱機械股份有限公司 Shini Plastics Technologies, Inc.		机器电压		3φ400V				
标记		更改前		更改后		更改人				日期		机器频率		50Hz		
1		2		3		4		5		6		7		8		

1	2	3	4	5	6	7	8		
序号/NO	符号/Symbol	名称/Name	制造商/Manufacturer	型号/Type	规格/Specification	数量/Number	物料编号/Material number	备注/Remark	
26	K9 K10 K11 K15	中间继电器/Middle relay	Honeywell	GR-2C-AC24V	24VAC	4	YE03022400300	(5)	
27	K12	中间继电器/Middle relay	Honeywell	GR-2C-AC24V	24VAC	1	YE03022400300	(4)	
28	K13	定时器/Timer	YUYUN	TRF-N/3M	24VAC	1	YE86032400000	(5)	
29	K14	定时器/Timer	YUYUN	TH3A-NAB 60S	24VAC	1	YE86602400300	(5)	
30	F1	热过载继电器/Overload relay	SIEMENS	3RU5136-4FB0	28-40A	1	YE01513600100		
31	F2	热过载继电器/Overload relay	SIEMENS	3RU6116-1FB0	3.5-5A	1	YE01160350000		
32	F2	热过载继电器/Overload relay	SIEMENS	3RU6126-4BB0	14-20A	1	YE01260140000	(6)	
33	F3	热过载继电器/Overload relay	SIEMENS	3RU6116-1BB0	1.4-2A	1	YE01160140000	(2)	
34	K16	中间继电器/Middle relay	Honeywell	GR-2C-AC24V	24VAC	1	YE03022400300		
35	S1	急停按钮/Emergency stop button	SCHNEIDER	XB2BS542C	400VAC	1	YE11254200000	(1)	
36		触点块/Contact block	SCHNEIDER	ZB2BE102C	1NC	1	YE00210203100	(1)(4)	
37	S2	停止按钮/Stop button	SCHNEIDER	XB2BA22C	400VAC	1	YE11222000000	(1)	
38	S3,H1	启动按钮(带灯)/Start button	SCHNEIDER	XB2BW33B1C	24VAC	1	YE11233100000	(1)	
39		触点块/Contact block	SCHNEIDER	ZB2BE101C	1NO	1	YE00210103100	(1)(4)	
40	S4,S5	安全开关/Safety switch	SCHMERSRC	AZ15-02ZVRK-1476	24VAC	2	YE16147600100	(1)	
41	S4,S5	安全开关/Safety switch	SCHMERSRC	AZ16-02ZVRK-1476	24VAC	2	YE16147600000	(1)(4)	
42	H2	三色警报灯/Alarm lamp	SHINI	红绿黄优先顺序+蜂鸣器	24VAC/DC 50/60Hz	1	BL90002401520	(1)	
43	H3	蜂鸣器/Buzzer	TEND	EA-2	24VAC	1	YE84240200000	(1)(3)	
44	MS	料位马达/Feed position motor	SHINI	SR-80	24VAC	1	YE15802400100	(1)(3)	
45	X1	端子排/Terminal	Honeywell	GK16PE	16mm ² PE	1	YE60001603500		
46	X2	端子排/Terminal	Honeywell	GK6	6mm ²	6	YE60000603200		
47			Honeywell	GK6PE	6mm ² PE	1	YE60000603500		
48	X3	端子排/Terminal	Honeywell	SK2.5	2.5mm ²	21	YE60002503200		
49			Honeywell	GK2.5PE	2.5mm ² PE	1	YE60002503400		
50			Honeywell	SK2.5	2.5mm ²	5	YE60002503200	(2)	
机型版本 Ver.E		注: (1)表示非电控箱内材料; (2)表示除尘马达选配件; (3)表示满料报警装置选配件; (4)表示安全继电器选配件; (5)表示皮带输送机选配件; (6)表示加大风机功率选配件。							
D			制图	版号	M	标题	图号	比例	第 8 张
			设计	核		SG-4360	SG-4360(H)-CE-400V-M-8	标准	CE
			校对	准		电气元件明细二			共 12 张
	标记	更改前	更改后	更改人	日期	审核	日期	20220805	SHINI 信易電熱機械股份有限公司 Shini Plastics Technologies, Inc.
1	2	3	4	5	6	7	8		

1	2	3	4	5	6	7	8			
序号/NO	符号/Symbol	名称/Name	制造商/Manufacturer	型号/Type	规格/Specification	数量/Number	物料编号/Material number	备注/Remark		
51			Honeywell	GK2.5PE	2.5mm ² PE	1	YE60002503400	(2)		
52			Honeywell	SK2.5	2.5mm ²	4	YE60002503200	(3)		
53			Honeywell	SK2.5	2.5mm ²	2	YE60002503200	(5)		
54			Honeywell	SK2.5	2.5mm ²	8	YE60002503200	(4)		
55			Honeywell	SK6	6mm ²	3	YE60000603200	(6)		
56			Honeywell	SK6PE	6mm ² PE	1	YE60000603500	(6)		
57		终端固定件B/GX系列	Honeywell	----	PCS	4	YE60000003900			
58	X4	金属接头/Metal tie in	SHINI	PLT-162-RR(公)	2P	1	YE68016200100	(1)(5)		
59	X10	金属接头/Metal tie in	SHINI	PLT-254-PM	4P	1	YE68025400000	(1)(3)		
60		金属接头/Metal tie in	SHINI	PLT-254-RF	4P	1	YE68025400100	(1)(3)		
61	X11	重载接插件/Heavy duty connector	HARTING	16P+PE(公插+母座)	16P	1	YE68001601300	(1)		
62	PCB	微电脑板/PCB	YUYUN	AB-02	24VAC	1	YE80022400100			
63		塑膠外壳SI-4T線路板用	----	----	----	1	YR40000400100			
64	PA	电流表/Galvanometry	SFIM	DH-670	100/5A	1	YE25671000000	(1)		
65	TA1	电流互感器/Current mutual inductance	RATIO	RQT-10	100/5A	1	YE04100500000			
66	TA2	电流互感器/Current mutual inductance	YUYUN	----	5-100A	1	----	线路板自带		
67	M1	粉碎电机/Granulating motor	----	----	400V 50Hz 30kW	1	----	(1)		
68	M2	送料风车/Solution blower	----	----	400V 50Hz 2.2kW	1	----	(1)		
69	M2	送料风车/Solution blower	----	----	400V 50Hz 7.5kW	1	----	(1)(6)		
70	M3	除尘风车/Dust blower	----	----	400V 50Hz 0.75kW	1	----	(1)(2)		
机型版本 Ver.E		注: (1)表示非电控箱内材料; (2)表示除尘马达选配配件; (3)表示满料报警装置选配配件; (4)表示安全继电器选配配件; (5)表示皮带输送机选配配件; (6)表示加大风机功率选配项。								
D			制图	版号	M	标题	SG-4360	图号	比例	第 9 张
			设计	核准		电气元件明细三	SG-4360(H)-CE-400V-M-9	标准	CE	共 12 张
			校对			 信易電熱機械股份有限公司 Shini Plastics Technologies, Inc.	机器电压	3φ400V		
	标记	更改前	更改后	更改人	日期		20220805	机器频率	50Hz	
1	2	3	4	5	6	7	8			

1		2		3		4		5		6		7		8	
序号/NO	符号/Symbol	名称/Name		制造商/Manufacturer	型号/Type		规格/Specification		数量/Number	物料编号/Material number		备注/Remark			
1	Q1	门连锁断路器/Gate circuit breaker		TECO	TAX-125L3125 3P		125A		1	YE40125301100					
2		断路器外部操作把手/External operating handle		TECO	FB1R-CS1-C-D1 (TAX-125)		----		1	YE90111100300					
3	Q2	断路器/Circuit-breaker		TECO	BM-63C/3P		10A		1	YE40301003000					
4	Q2	断路器/Circuit-breaker		TECO	BM-63C/3P		32A		1	YE40303203000		(6)			
5	Q3	断路器/Circuit-breaker		TECO	BM-63C/3P		6A		1	YE40300603000		(2)			
6	Q4	断路器/Circuit-breaker		TECO	BM-63C/2003S 2P		3A		1	YE40200203000					
7	Q5	断路器/Circuit-breaker		TECO	BM-63C/1010S 1P		10A		1	YE40101000100					
8	K1,K2	接触器/Contactor		SIEMENS	3RT5036-1AC20		50A 24 VAC 50/60Hz		2	YE00503602600					
9		辅助触点/Auxiliary Contactor		SIEMENS	3RH5921-1CA10		1NO		1	YE00592110000					
10	K3	接触器/Contactor		SIEMENS	3RT5035-1AC20		40A 24 VAC 50/60Hz		1	YE00503502600					
11		辅助触点/Auxiliary Contactor		SIEMENS	3RH5921-1CA01		1NC		2	YE00592110100					
12		辅助触点/Auxiliary Contactor		SIEMENS	3RH5921-1CA10		1NO		1	YE00592110000		(5)			
13		辅助触点/Auxiliary Contactor		SIEMENS	3RH5921-1CA01		1NC		1	YE00592110100		(4)			
14	K4	接触器/Contactor		SIEMENS	3RT6016-1AB01		9A 24 VAC 50/60Hz		1	YE00601602500					
15	K4	接触器/Contactor		SIEMENS	3RT6026-1AC20		25A 24 VAC 50/60Hz		1	YE00602602600		(6)			
16		辅助触点/Auxiliary Contactor		SIEMENS	3RH6911-1HA11		1NC+1NO		1	YE00691100100					
17	K5	接触器/Contactor		SIEMENS	3RT6016-1AB02		9A 24 VAC 50/60Hz		1	YE00601602600		(2)			
18	K6	接触器/Contactor		SIEMENS	3RT5046-1AC20		95A 24 VAC 50/60Hz		1	YE00504602600		(4)			
19		辅助触点/Auxiliary Contactor		SIEMENS	3RH5921-1CA01		1NC		1	YE00592110100		(4)			
20		辅助触点/Subsidiary Contactor		SIEMENS	3RH5921-1CA10		1NO		1	YE00592110000		(4)			
21	K7	中间继电器/Middle relay		Honeywell	GR-2C-AC24V		24 VAC		1	YE03022400300					
22	K7	中间继电器/Middle relay		Honeywell	GR-4C-AC24V		24 VAC		1	YE03042400300		(5)			
23	K8	安全继电器/Safety relay		PILZ	PNOZ×2.8P		24 V AC/DC		1	YE04023000000		(4)			
24	K9 K10 K11 K15	中间继电器/Middle relay		Honeywell	GR-2C-AC24V		24 VAC		4	YE03022400300		(5)			
25	K12	中间继电器/Middle relay		Honeywell	GR-2C-AC24V		24 VAC		1	YE03022400300		(4)			
机型版本 Ver E		注: (1)表示非电控箱内材料; (2)表示除尘风机选配件; (3)表示满料报警装置选配件; (4)表示安全继电器选配件; (5)表示皮带输送机选配件; (6)表示加大风机功率选配件。													
				制图	版号 M		标题 SG-4360H		图号 SG-4360(H)-CE-400V-M-10		比例	第 10 张			
				设计	核 准		电气元件明细一				标准	CE 共 12 张			
				校对			 信易電熱機械股份有限公司 Shini Plastics Technologies, Inc.				机器电压	3φ400V			
标记	更改前	更改后	更改人	日期	审核	日期			20220805	机器频率	50Hz				
1		2		3		4		5		6		7		8	

1	2		3	4	5	6	7		8		
序号/NO	符号/Symbol	名称/Name	制造商/Manufacturer	型号/Type	规格/Specification	数量/Number	物料编号/Material number	备注/Remark			
26	K13	定时器/Timer	YUYUN	TRF-N/3M	24VAC	1	YE86032400000	(5)			
27	K14	定时器/Timer	YUYUN	TH3A-NAB 60S	24VAC	1	YE86602400300	(5)			
28	F1	热过载继电器/Overload relay	SIEMENS	3RU5136-4GB0	36-45A	1	YE01612660000				
29	F2	热过载继电器/Overload relay	SIEMENS	3RU6116-1FB0	3.5-5A	1	YE01160350000				
30	F2	热过载继电器/Overload relay	SIEMENS	3RU6126-4BB0	14-20A	1	YE01260140000	(6)			
31	F3	热过载继电器/Overload relay	SIEMENS	3RU6116-1BB0	1.4-2A	1	YE01160140000	(2)			
32	K16	中间继电器/Middle relay	Honeywell	GR-2C-AC24V	24VAC	1	YE03022400300				
33	S1	急停按钮/Emergency stop button	SCHNEIDER	XB2BS542C	400VAC	1	YE11254200000	(1)			
34		触点块/Contact block	SCHNEIDER	ZB2BE102C	1NC	1	YE00210203100	(1)(4)			
35	S2	停止按钮/Stop button	SCHNEIDER	XB2BA22C	400VAC	1	YE11222000000	(1)			
36	S3.H1	启动按钮(带灯)/Start button	SCHNEIDER	XB2BW33B1C	24VAC	1	YE11233100000	(1)			
37		触点块/Contact block	SCHNEIDER	ZB2BE101C	1NO	1	YE00210103100	(1)(4)			
38	S4,S5	安全开关/Safety switch	SCHMERSRC	AZ16-02ZVRK-1476	230VAC	2	YE16147600000	(1)(4)			
39	S4,S5	安全开关/Safety switch	SCHMERSRC	AZ15-02ZVRK-1476	230VAC	2	YE16147600100	(1)			
40	H2	三色警报灯/Alarm lamp	SHINI	红绿黄优先顺序+蜂鸣器	24VAC/DC 50/60Hz	1	BL90002401520	(1)			
41	H3	蜂鸣器/Buzzer	TEND	EA-2	24VAC	1	YE84240200000	(1)(3)			
42	MS	料位马达/Feed position motor	SHINI	SR-80	24VAC	1	YE15802400100	(1)(3)			
43	T	互感变压器/Transformer	----	IN=400V/415V OUT=24V	180VA	1	YE70040006700				
44	T	互感变压器/Transformer	----	IN=400V/415V OUT=24V	350VA	1	YE70040009900	(4)			
45	TA1	电流互感器/Current mutual inductance	RATIO	RQT-35	100/5A	1	YE04100500000				
46	PA	电流表/Galvanometry	SFIM	DH-670	100/5A	1	YE25671000000	(1)			
47	PCB	微电脑板/PCB	YUYUN	AB-02	24VAC	1	YE80022400100				
48		塑膠外壳SI-4T線路板用	----	----	----	1	YR40000400100				
49	TA2	电流互感器/Current mutual inductance	YUYUN	----	5-100A	1	----	线路板自带			
50	X1	端子排/Terminal	Honeywell	GK16PE	16mm ² PE	1	YE60001603500				
机型版本 Ver.E		注: (1)表示非电控箱内材料; (2)表示除尘风机选配件; (3)表示满料报警装置选配件; (4)表示安全继电器选配件; (5)表示皮带输送机选配件; (6)表示加大风机功率选项。									
				制图	版号 M	标题 SG-4360H		图号	比例	第 11 张	
				设计	核 准	电气元件明细二		SG-4360(H)-CE-400V-M-11	标准 CE	共 12 张	
				校对				信易電熱機械股份有限公司		机器电压	3φ400V
				审核	日期 20220805			Shini Plastics Technologies, Inc.		机器频率	50Hz
1	2	3	4	5	6	7	8				

1	2	3	4	5	6	7	8		
序号/NO	符号/Symbol	名称/Name	制造商/Manufacturer	型号/Type	规格/Specification	数量/Number	物料编号/Material number	备注/Remark	
51	X2	端子排/Terminal	Honeywell	GK10	10mm ²	6	YE60001003200		
52		端子排/Terminal	Honeywell	GK10PE	10mm ² PE	1	YE60001003500		
53	X3	端子排/Terminal	Honeywell	SK2.5	2.5mm ²	21	YE60002503200		
54			Honeywell	GK2.5PE	2.5mm ² PE	1	YE60002503400		
55			Honeywell	SK2.5	2.5mm ²	5	YE60002503200	(2)	
56			Honeywell	GK2.5PE	2.5mm ² PE	1	YE60002503400	(2)	
57			Honeywell	SK2.5	2.5mm ²	4	YE60002503200	(3)	
58			Honeywell	SK2.5	2.5mm ²	2	YE60002503200	(5)	
59			Honeywell	SK2.5	2.5mm ²	8	YE60002503200	(4)	
60			Honeywell	SK6	6mm ²	3	YE60000603200	(6)	
61			Honeywell	SK6PE	6mm ² PE	1	YE60000603500	(6)	
62		终端固定件E/GX系列	Honeywell	----	PCS	4	YE60000003900		
63	X4	金属接头/Metal tie in	SHINI	PLT-162-RR(公)	2P	1	YE68016200100	(1)(5)	
64	X10	金属接头/Metal tie in	SHINI	PLT-254-PM	4P	1	YE68025400000	(1)(3)	
65		金属接头/Metal tie in	----	PLT-254-RF	4P	1	YE68025400100	(1)(3)	
66	X11	重载接插件/Heavy duty connector	HARTING	16P+PE(公插-母座)	16P	1	YE68001601300	(1)	
67	M1	粉碎电机/Granulating motor	----	----	400V 50Hz 37kW	1	----	(1)	
68	M2	送料风车/Solution blower	----	----	400V 50Hz 2.2kW	1	----	(1)	
69	M2	送料风车/Solution blower	----	----	400V 50Hz 7.5kW	1	----	(1)(6)	
70	M3	除尘风车/Dust blower	----	----	400V 50Hz 0.75kW	1	----	(1)(2)	
机型版本 Ver.E		注: (1)表示非电控箱内材料; (2)表示除尘风机选配件; (3)表示满料报警装置选配件; (4)表示安全继电器选配件; (5)表示皮带输送机选配件; (6)表示加大风机功率选配件。							
			制图	版号 M	标题 SG-4360H	图号	比例	第 12 张	
			设计	核准	电气元件明细三	SG-4360(H)-CE-400V-M-12	标准 CE	共 12 张	
			校对			信易電熱機械股份有限公司 Shini Plastics Technologies, Inc.	机器电压	3φ400V	
标记	更改前	更改后	更改人	日期			审核	日期	20220805
1	2	3	4	5	6	7	8		

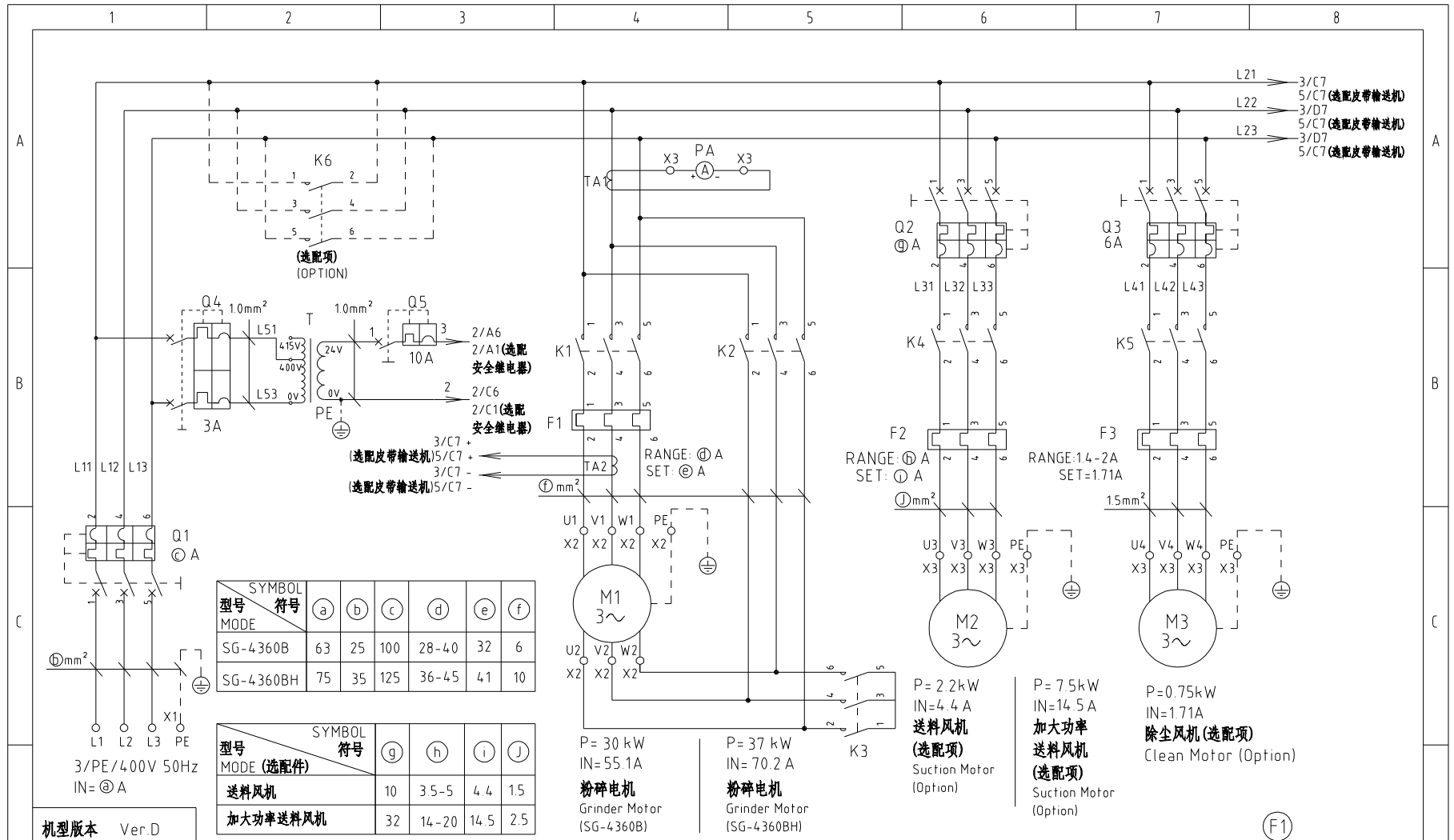

SYMBOL	型号	符号	a	b	c	d	e	f
MODE	SG-4360B		63	25	100	28-40	32	6
	SG-4360BH		75	35	125	36-45	41	10

SYMBOL	型号	符号	g	h	i	j
MODE (选配件)	送料风机		10	3.5-5	4.4	1.5
	加大功率送料风机		32	14-20	14.5	2.5

机型版本 Ver.D
3/PE/400V 50Hz
IN=ⓐA

制图			版号		F	标题		图号		比例		第 1 张			
设计			核准			SG-4360(H) 主电路图		SG-4360(H)-GB-400V-F-1		标准		GB 共 12 张			
校对			日期		20220805	信易電熱機械股份有限公司 Shini Plastics Technologies, Inc.		机器电压		3φ400V		机器频率		50Hz	
更改前			更改后					更改人		日期					

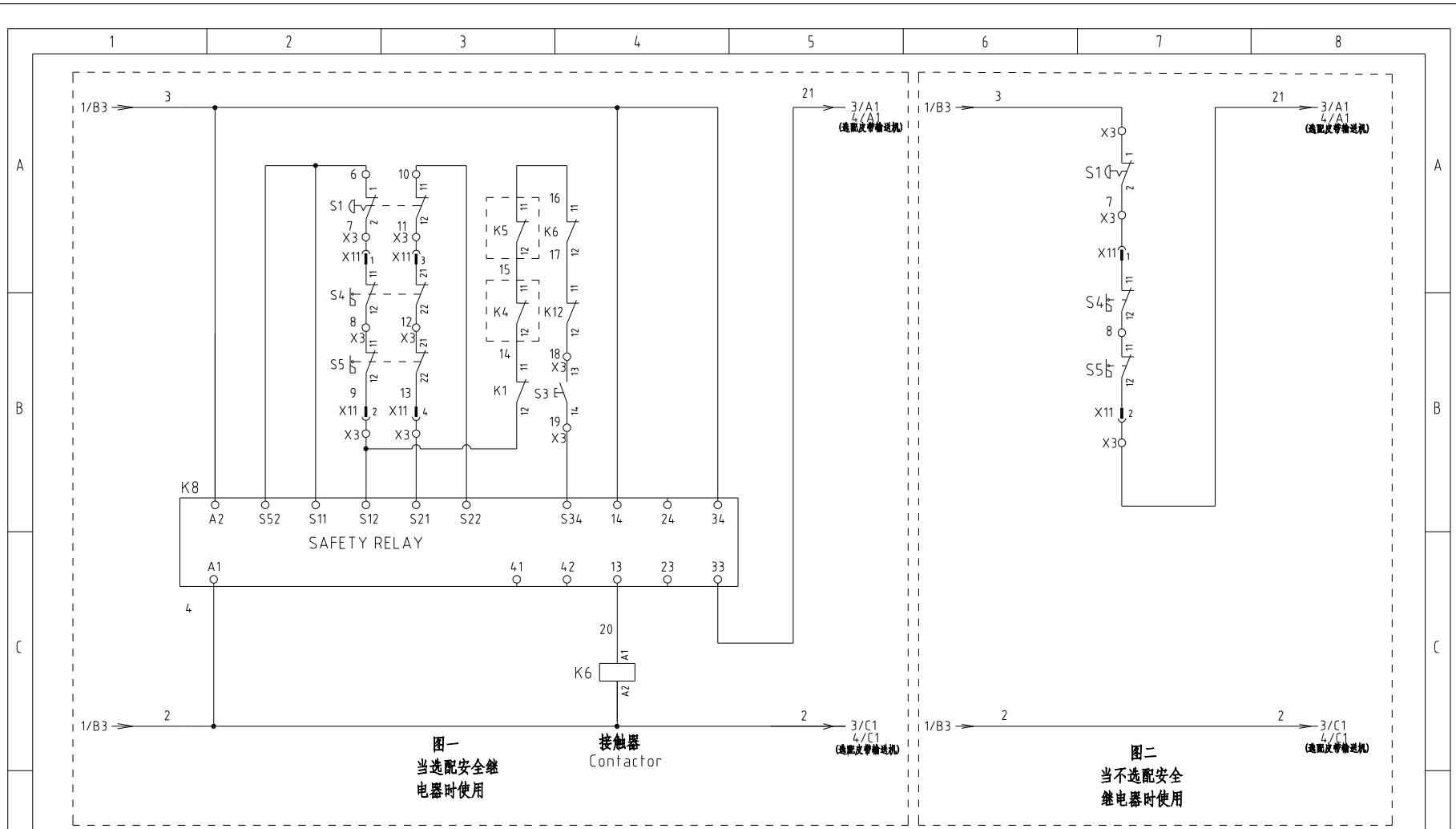

机型版本 Ver.D

(F1)

				制图		版号	F
				设计		核准	
(F1)	标准CE	标准GB		校对		日期	20220805
标记	更改前	更改后	更改人	日期	审核	日期	20220805

标题 SG-4360B(H) 控制电路图一
图号 SG-4360B(H)-GB-400V-F-2

SHINI 信易電熱機械股份有限公司
Shini Plastics Technologies, Inc.

比例	第 2 张
标准 GB	共 12 张
机器电压	3φ400V
机器频率	50Hz

1 2 3 4 5 6 7 8

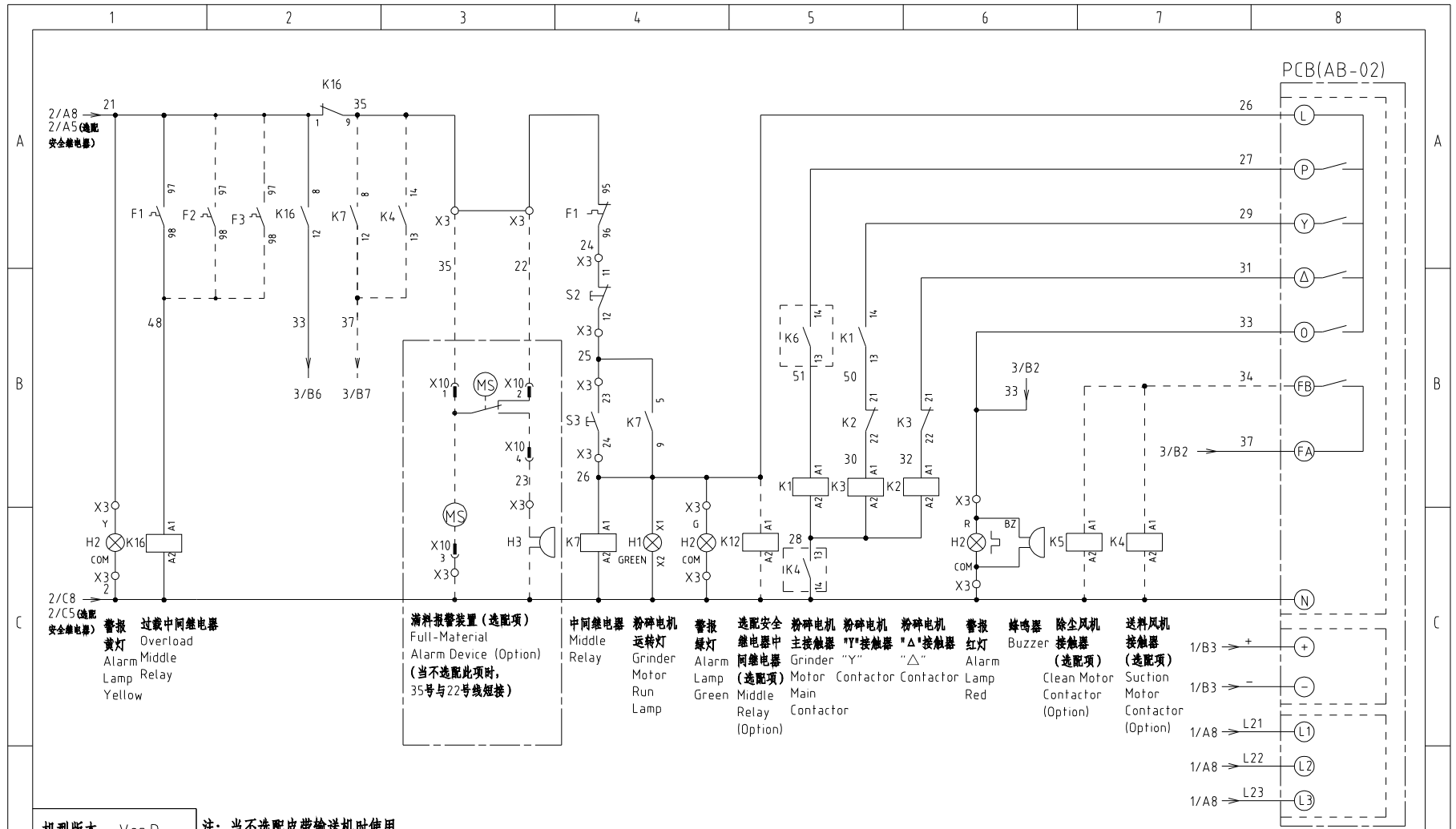

2/C8
2/C5 (选配
安全继电器)

警报 过载中间继电器
黄灯 Overload
Alarm Middle
Lamp Relay
Yellow

满料报警装置 (选选项)
Full-Material
Alarm Device (Option)
(当不选配此项时,
35号与22号线短接)

中间继电器 粉碎机
Middle Relay Grinder
Run Lamp

警报 选配安全
继电器中
间继电器
警报
红灯
Alarm
Lamp
Red

选配安全 粉碎机 粉碎机 粉碎机
继电器中 主接触器 "Y"接触器 "Δ"接触器
中间继电器 Motor Contactor Contactor
Middle Main Contactor
Relay Contactor
(Option)

警报 蜂鸣器 除尘风机
红灯 Buzzer 接触器
Alarm Lamp Red Clean Motor
Contactor
(Option)

送料风机
接触器
(选选项)
Suction
Motor
Contactor
(Option)

机型版本 Ver.D 注: 当不选配皮带输送机时使用。

制图		版号 F		标题 SG-4360B(H) 控制电路图二		图号 SG-4360B(H)-GB-400V-F-3		比例 (F1) 第 3 张	
设计		核准		SHINI 信易電熱機械股份有限公司 Shini Plastics Technologies, Inc.		标准 GB		共 12 张	
(F1) 标准CE	标准GB	校对		日期 20220805		机器电压 3φ400V		机器频率 50Hz	
标记 更改前	更改后	更改人	日期						

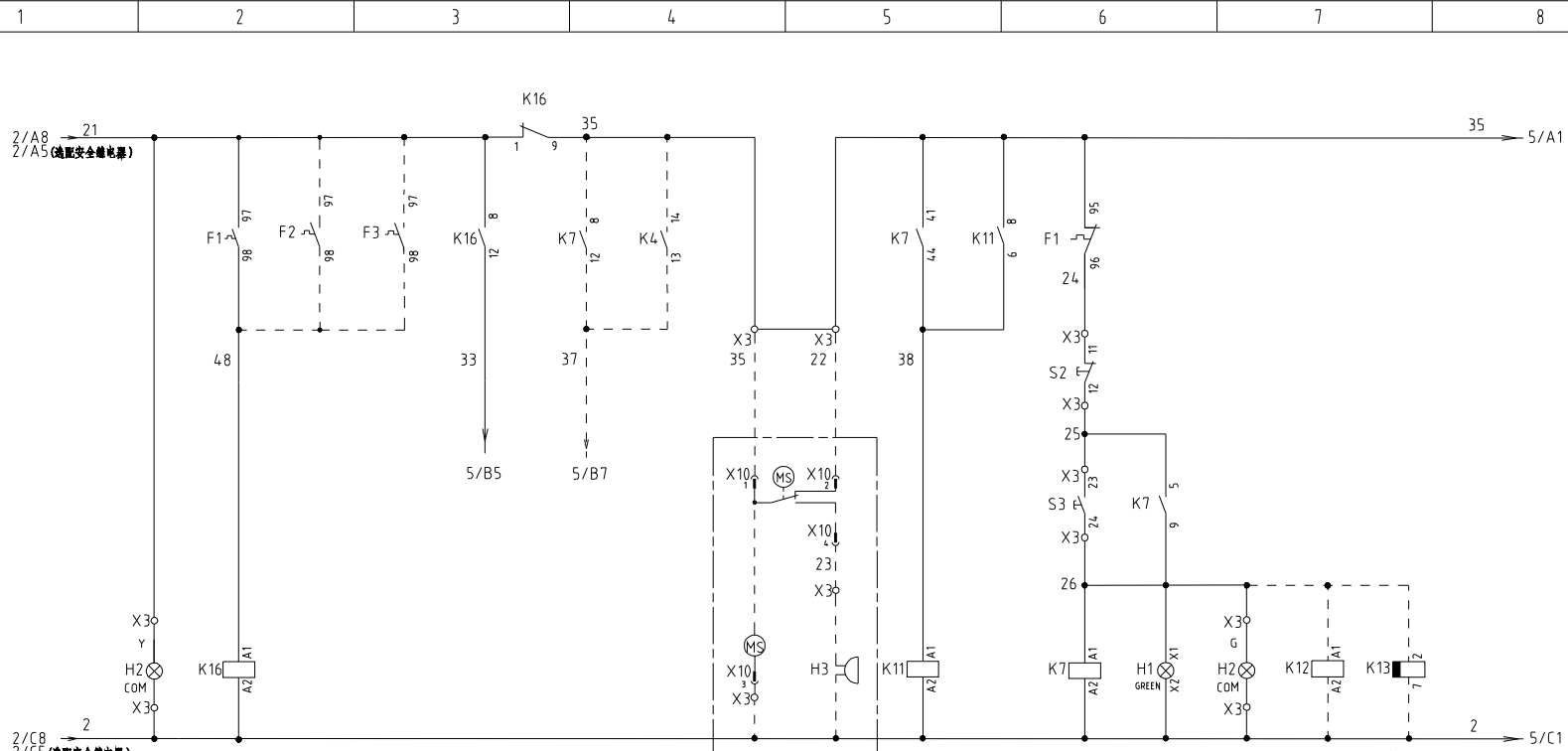

- 报警黄灯 Alarm Lamp Yellow
- 过载中间继电器 Overload Middle Relay
- 满料报警装置 (选配项) Full-Material Alarm Device (Option) (当不选配此项时, 35号与22号线短接)
- 皮带输送机中间继电器 (选配项) Belt Conveyor Middle Relay (Option)
- 中间继电器 Middle Relay
- 粉碎电机运转灯 Grinder Motor Run Lamp
- 报警绿灯 Alarm Lamp Green
- 选配安全继电器中间继电器 (选配项) Middle Relay (Option)
- 主机延时停机时间继电器 (选配项) Grinder Motor Delay Stoppage Time Relay (Option)

机型版本 Ver.D		注: 当选配皮带输送机时使用。			制图		版号 F		标题 SG-4360B(H) 控制电路图三		图号 SG-4360B(H)-GB-400V-F-4		比例 第 4 张	
					设计		核准				标准 GB		共 12 张	
F1 标准CE		标准GB			校对		日期 20220805		信易电热机械股份有限公司 Shini Plastics Technologies, Inc.		机器电压 3φ400V			
标记 更改前		更改后			更改人		日期				机器频率 50Hz			

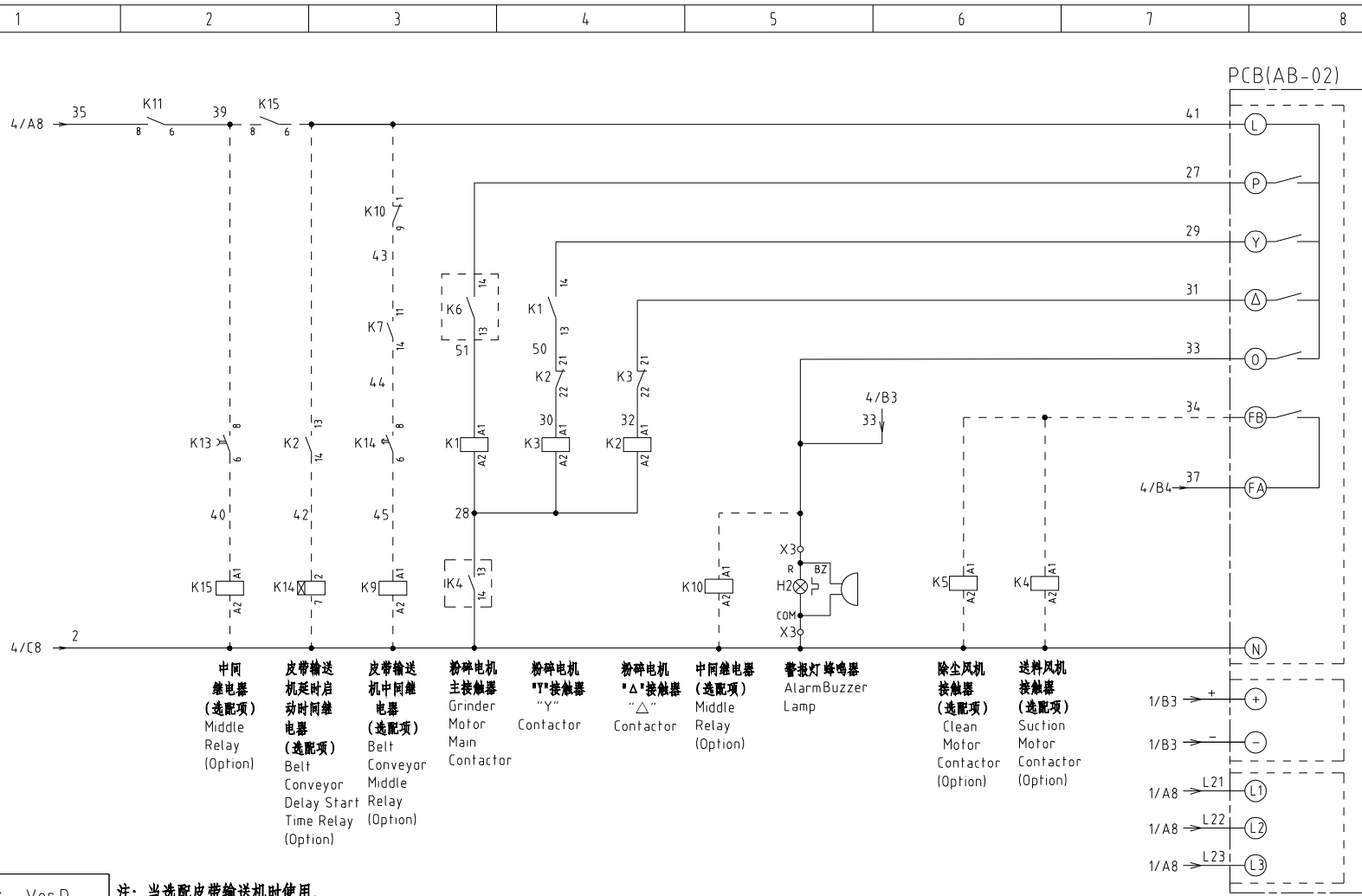

- 中间继电器 (选项) Middle Relay (Option)
- 皮带输送机延时启动时间继电器 (选项) Belt Conveyor Delay Start Time Relay (Option)
- 皮带输送机中间继电器 (选项) Belt Conveyor Middle Relay (Option)
- 粉碎电机主接触器 Grinder Motor Main Contactor
- 粉碎电机“Y”接触器 Contactor
- 粉碎电机“Δ”接触器 Contactor
- 中间继电器 (选项) Middle Relay (Option)
- 警报灯蜂鸣器 Alarm Buzzer Lamp
- 除尘风机接触器 (选项) Clean Motor Contactor (Option)
- 送料风机接触器 (选项) Suction Motor Contactor (Option)

机型版本 Ver.D 注: 当选配皮带输送机时使用。

			制图	版号	F	标题	图号	比例	第 5 张
			设计	核准		SG-4360B(H) 控制电路图三	SG-4360B(H)-GB-400V-F-5	标准	共 12 张
(F1)	标准CE	标准GB	校对	核准		信易電熱機械股份有限公司 Shini Plastics Technologies, Inc.	机器电压	3φ400V	
标记	更改前	更改后	更改人	日期	20220805		机器频率	50Hz	
1	2	3	4	5	6	7	8		

选配皮带输送机控制触点接线示意图

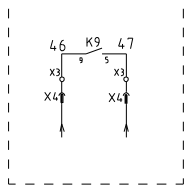

X4 金属接头接线示意图
接皮带输送机
(选配项)

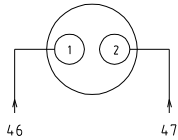

X10 金属接头接线示意图
接满料报警装置
(选配项)

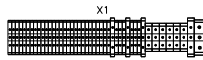
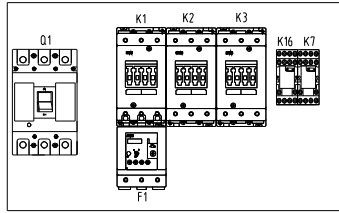
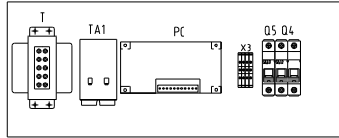
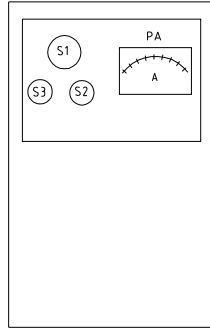
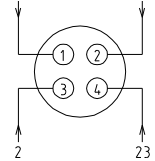

标准机型布局图

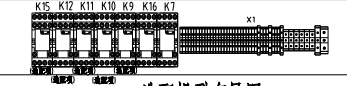
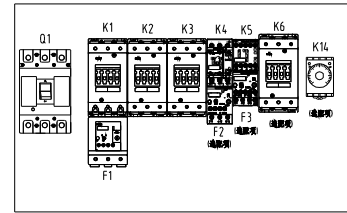
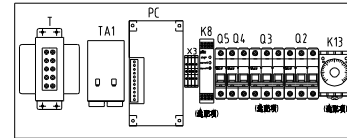

选配机型布局图

X11: 16P 重载插件

①	7	⑨	
②	9	⑩	
③	11	⑪	
④	13	⑫	
⑤		⑬	
⑥		⑭	
⑦		⑮	
⑧		⑯	

注: 当不选配安全继电器时将9号端子改为21号, 11号端子和13号端子不用接

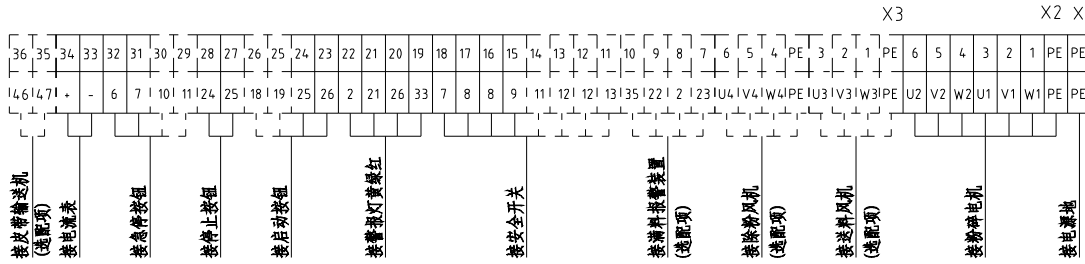

机型版本 Ver.D

注: 当不选配安全继电器时将6号端子改为3号, 9号端子改为21号。

(F1)

				制图		版号	F	标题	SG-4360B(H) 电气元件布置图	图号	SG-4360B(H)-GB-400V-F-6	比例	第 6 张	
				设计		核准		信易电热机械股份有限公司 Shini Plastics Technologies, Inc.				标准	GB	共 12 张
(F1)	标准CE	标准GB		校对		日期	20220805					机器电压	3φ400V	
标记	更改前	更改后	更改人	日期	审核	日期				机器频率			50Hz	

1		2		3		4		5		6		7		8	
序号/NO	符号/Symbol	名称/Name		制造商/Manufacturer		型号/Type		规格/Specification		数量/Number	物料编号/Material number		备注/Remark		
A	1	Q1	断路器/Circuit breaker		TECO		BO100EB3100 3P		100A		1	YE40100300400			
	2		断路器外部操作把手/External operating handle		TECO		1A-CS1-C-D1 (BO100EB)		----		1	YE90111100100			
	3	Q2	断路器/Circuit-breaker		TECO		BM-63C/3P		10A		1	YE40301003000		(6)	
	4	Q2	断路器/Circuit-breaker		TECO		BM-63C/3P		32A		1	YE40303203000		(7)	
	5	Q3	断路器/Circuit-breaker		TECO		BM-63C/3P		6A		1	YE40300603000		(2)	
	6	Q4	断路器/Circuit-breaker		TECO		BM-63C/2003S 2P		3A		1	YE40200203000			
	7	Q5	断路器/Circuit-breaker		TECO		BM-63C/1010S 1P		10A		1	YE40101000100			
B	8	K1,K2	接触器/Contactor		SIEMENS		3RT5035-1AC20		40A 24VAC 50/60Hz		2	YE00503502600			
	9		辅助触点/Auxiliary Contactor		SIEMENS		3RH5921-1CA01		1NC		1	YE00592110100		(4)	
	10		辅助触点/Auxiliary Contactor		SIEMENS		3RH5921-1CA01		1NC		1	YE00592110100			
	11		辅助触点/Auxiliary Contactor		SIEMENS		3RH5921-1CA10		1NO		1	YE00592110000		(5)	
	12		辅助触点/Auxiliary Contactor		SIEMENS		3RH5921-1CA10		1NO		1	YE00592110000			
	13	K3	接触器/Contactor		SIEMENS		3RT6028-1AC20		38A 24VAC 50/60Hz		1	YE00602802600			
	14	K4	接触器/Contactor		SIEMENS		3RT6016-1AB01		9A 24VAC 50/60Hz		1	YE00601602500		(6)	
C	15	K4	接触器/Contactor		SIEMENS		3RT6026-1AC20		25A 24VAC 50/60Hz		1	YE00602602600		(7)	
	16		辅助触点/Auxiliary Contactor		SIEMENS		3RH6911-1HA11		1NC+1NO		1	YE00691100100		(6)	
	17	K5	接触器/Contactor		SIEMENS		3RT6016-1AB02		9A 24VAC 50/60Hz		1	YE00601602600		(2)	
	18	K6	接触器/Contactor		SIEMENS		3RT5045-1AC20		80A 24VAC 50/60Hz		1	YE00504502600		(4)	
	19		辅助触点/Auxiliary Contactor		SIEMENS		3RH5921-1CA01		1NC		1	YE00592110100		(4)	
	20		辅助触点/Subsidiary Contactor		SIEMENS		3RH5921-1CA10		1NO		1	YE00592110000		(4)	
	21	K7	中间继电器/Middle relay		Honeywell		GR-2C-AC24V		24VAC		1	YE03022400300			
D	22	K7	中间继电器/Middle relay		Honeywell		GR-4C-AC24V		24VAC		1	YE03042400300		(5)	
	23	K8	安全继电器/Safety relay		PILZ		PNOZ×2.8P		24V AC/DC		1	YE04023000000		(4)	
	24	T	互感变压器/Transformer		----		IN=400V/415V OUT=24V		180VA		1	YE70040006700		选配(4)时去掉	
	25	T	互感变压器/Transformer		----		IN=400V/415V OUT=24V		350VA		1	YE70040009900		(4)	
	机型版本 Ver.D		注: (1)表示非电控箱内材料; (2)表示除尘马达选配; (3)表示满料报警装置选配; (4)表示安全继电器选配; (5)表示皮带输送机选配; (6)表示送料风机选配; (7)表示大功率送料风机选配。 (F1)												
				制图		版号 F		标题 SG-4360B		图号 SG-4360B(H)-GB-400V-F-7		比例		第 7 张	
				设计		核准		电气元件明细一				标准 GB		共 12 张	
(F1)		标准CE		标准GB		校对		 信易電熱機械股份有限公司 Shini Plastics Technologies, Inc.		机器电压		3φ400V			
标记		更改前		更改后		更改人				日期		机器频率		50Hz	
1		2		3		4		5		6		7		8	

1	2	3	4	5	6	7	8	
序号/NO	符号/Symbol	名称/Name	制造商/Manufacturer	型号/Type	规格/Specification	数量/Number	物料编号/Material number	备注/Remark
26	K12	中间继电器/Middle relay	Honeywell	GR-2C-AC24V	24VAC	1	YE03022400300	(4)
27	K13	定时器/Timer	YUYUN	TRF-N/3M	24VAC	1	YE86032400000	(5)
28	K14	定时器/Timer	YUYUN	TH3A-NAB 60S	24VAC	1	YE86602400300	(5)
29	F1	热过载继电器/Overload relay	SIEMENS	3RU5136-4FB0	28-40A	1	YE01513600100	
30	F2	热过载继电器/Overload relay	SIEMENS	3RU6116-1FB0	3.5-5A	1	YE01160350000	(6)
31	F2	热过载继电器/Overload relay	SIEMENS	3RU6126-4BB0	14-20A	1	YE01260140000	(7)
32	F3	热过载继电器/Overload relay	SIEMENS	3RU6116-1BB0	14-2A	1	YE01160140000	(2)
33	K16	中间继电器/Middle relay	Honeywell	GR-2C-AC24V	24VAC	1	YE03022400300	
34		急停按钮/Emergency stop button	SCHNEIDER	XB2BS542C	400VAC	1	YE11254200000	(1)
35	S1	触点块/Contact block	SCHNEIDER	ZB2BE102C	1NC	1	YE00210203100	(1)(4)
36	S2	停止按钮/Stop button	SCHNEIDER	XB2BA22C	400VAC	1	YE11222000000	(1)
37	S3,H1	启动按钮(带灯)/Start button	SCHNEIDER	XB2BW33B1C	24VAC	1	YE11233100000	(1)
38		触点块/Contact block	SCHNEIDER	ZB2BE101C	1NO	1	YE00210103100	(1)(4)
39	S4,S5	安全开关/Safety switch	SCHMERSRC	AZ15-02ZVRK-1476	24VAC	2	YE16147600100	(1)
40	S4,S5	安全开关/Safety switch	SCHMERSRC	AZ16-02ZVRK-1476	24VAC	2	YE16147600000	(1)(4)
41	H2	三色警报灯/Alarm lamp	SHINI	红绿黄优先顺序+蜂鸣器	24VAC/DC 50/60Hz	1	BL90002401520	(1)
42	H3	蜂鸣器/Buzzer	TEND	EA-2	24VAC	1	YE84240200000	(1)(3)
43	MS	料位马达/Feed position motor	SHINI	SR-80	24VAC	1	YE15802400100	(1)(3)
44	X1	端子排/Terminal	Honeywell	GK16PE	16mm ² PE	1	YE60001603500	
45	X2	端子排/Terminal	Honeywell	GK6	6mm ²	6	YE60000603200	
46		端子排/Terminal	Honeywell	GK6PE	6mm ² PE	1	YE60000603500	
47	X3	端子排/Terminal	Honeywell	SK2.5	2.5mm ²	16	YE60002503200	
48			Honeywell	SK2.5	2.5mm ²	5	YE60002503200	(6)
49			Honeywell	GK2.5PE	2.5mm ² PE	1	YE60002503400	(6)/(7)
50	K9 K10 K11 K15	中间继电器/Middle relay	Honeywell	GR-2C-AC24V	24VAC	4	YE03022400300	(5)
机型版本 Ver.D		注: (1)表示非电控箱内材料; (2)表示除尘马达选配件; (3)表示满料报警装置选配件; (4)表示安全继电器选配件; (5)表示皮带输送机选配件; (6)表示送料风机选配件; (7)表示大功率送料风机选配件。 (F1)						
D			制图	版号	标题	图号	比例	第 8 张
			设计	核准	电气元件明细二	SG-4360B(H)-GB-400V-F-8	标准 GB	共 12 张
	(F1)	标准CE	标准GB	校对	 信易電熱機械股份有限公司 Shini Plastics Technologies, Inc.		机器电压	3φ400V
	标记	更改前	更改后	更改人			日期	20220805
1	2	3	4	5	6	7	8	

1		2		3		4		5		6		7		8	
序号/NO	符号/Symbol	名称/Name		制造商/Manufacturer	型号/Type		规格/Specification		数量/Number	物料编号/Material number		备注/Remark			
1	Q1	门连锁断路器/Gate circuit breaker		TECO	TAX-125L3125 3P		125A		1	YE40125301100					
2		断路器外部操作把手/External operating handle		TECO	FB1R-CS1-C-D1x(TAX-125)		----		1	YE90111100300					
3	Q2	断路器/Circuit-breaker		TECO	BM-63C/3P		10A		1	YE40301003000		(6)			
4	Q2	断路器/Circuit-breaker		TECO	BM-63C/3P		32A		1	YE40303203000		(7)			
5	Q3	断路器/Circuit-breaker		TECO	BM-63C/3P		6A		1	YE40300603000		(2)			
6	Q4	断路器/Circuit-breaker		TECO	BM-63C/2003S 2P		3A		1	YE40200203000					
7	Q5	断路器/Circuit-breaker		TECO	BM-63C/1010S 1P		10A		1	YE40101000100					
8	K1,K2	接触器/Contactor		SIEMENS	3RT5036-1AC20		50A 24 VAC 50/60Hz		2	YE00503602600					
9		辅助触点/Auxiliary Contactor		SIEMENS	3RH5921-1CA10		1NO		1	YE00592110000					
10	K3	接触器/Contactor		SIEMENS	3RT5035-1AC20		40A 24 VAC 50/60Hz		1	YE00503502600					
11		辅助触点/Auxiliary Contactor		SIEMENS	3RH5921-1CA01		1NC		2	YE00592110100					
12		辅助触点/Auxiliary Contactor		SIEMENS	3RH5921-1CA10		1NO		1	YE00592110000		(5)			
13		辅助触点/Auxiliary Contactor		SIEMENS	3RH5921-1CA01		1NC		1	YE00592110100		(4)			
14	K4	接触器/Contactor		SIEMENS	3RT6016-1AB01		9A 24 VAC 50/60Hz		1	YE00601602500		(6)			
15	K4	接触器/Contactor		SIEMENS	3RT6026-1AC20		25A 24 VAC 50/60Hz		1	YE00602602600		(7)			
16		辅助触点/Auxiliary Contactor		SIEMENS	3RH6911-1HA11		1NC+1NO		1	YE00691100100		(6)			
17	K5	接触器/Contactor		SIEMENS	3RT6016-1AB02		9A 24 VAC 50/60Hz		1	YE00601602600		(2)			
18	K6	接触器/Contactor		SIEMENS	3RT5046-1AC20		95A 24 VAC 50/60Hz		1	YE00504602600		(4)			
19		辅助触点/Auxiliary Contactor		SIEMENS	3RH5921-1CA01		1NC		1	YE00592110100		(4)			
20		辅助触点/Subsidiary Contactor		SIEMENS	3RH5921-1CA10		1NO		1	YE00592110000		(4)			
21	K7	中间继电器/Middle relay		Honeywell	GR-2C-AC24V		24 VAC		1	YE03022400300					
22	K7	中间继电器/Middle relay		Honeywell	GR-4C-AC24V		24 VAC		1	YE03042400300		(5)			
23	K8	安全继电器/Safety relay		PILZ	PNOZ×2.8P		24 V AC/DC		1	YE04023000000		(4)			
24	K9 K10 K11 K15	中间继电器/Middle relay		Honeywell	GR-2C-AC24V		24 VAC		4	YE03022400300		(5)			
25	K12	中间继电器/Middle relay		Honeywell	GR-2C-AC24V		24 VAC		1	YE03022400300		(4)			
机型版本 Ver.D		注: (1)表示非电控箱内材料; (2)表示除尘风机选配件; (3)表示满料报警装置选配件; (4)表示安全继电器选配件; (5)表示皮带输送机选配件; (6)表示送料风机选配件; (7)表示大功率送料风机选配件。 (F1)													
				制图	版号 F		标题 SG-4360BH		图号 SG-4360B(H)-GB-400V-F-10		比例	第 10 张			
				设计	核 准		电气元件明细一				标准 GB	共 12 张			
(F1)		标准CE	标准GB	校对	核 准		 信易電熱機械股份有限公司 Shini Plastics Technologies, Inc.		机器电压		3φ400V				
标记 更改前		更改后	更改人	日期	审核	日期			20220805	机器频率		50Hz			
1		2		3		4		5		6		7		8	

1	2	3	4	5	6	7	8		
序号/NO	符号/Symbol	名称/Name	制造商/Manufacturer	型号/Type	规格/Specification	数量/Number	物料编号/Material number	备注/Remark	
26	K13	定时器/Timer	YUYUN	TRF-N/3M	24VAC	1	YE86032400000	(5)	
27	K14	定时器/Timer	YUYUN	TH3A-NAB 60S	24VAC	1	YE86602400300	(5)	
28	F2	热过载继电器/Overload relay	SIEMENS	3RU6116-1FB0	3.5-5A	1	YE01160350000	(6)	
29	F2	热过载继电器/Overload relay	SIEMENS	3RU6126-4BB0	14-20A	1	YE0126014-0000	(7)	
30	F1	热过载继电器/Overload relay	SIEMENS	3RU5136-4GB0	36-45A	1	YE01612660000		
31	F3	热过载继电器/Overload relay	SIEMENS	3RU6116-1BB0	1.4-2A	1	YE0116014-0000	(2)	
32	K16	中间继电器/Middle relay	Honeywell	GR-2C-AC24V	24VAC	1	YE03022400300		
33	S1	急停按钮/Emergency stop button	SCHNEIDER	XB2BS542C	400VAC	1	YE11254200000	(1)	
34		触点块/Contact block	SCHNEIDER	ZB2BE102C	1NC	1	YE00210203100	(1)(4)	
35	S2	停止按钮/Stop button	SCHNEIDER	XB2BA22C	400VAC	1	YE11222000000	(1)	
36	S3,H1	启动按钮(带灯)/Start button	SCHNEIDER	XB2BW33B1C	24VAC	1	YE11233100000	(1)	
37		触点块/Contact block	SCHNEIDER	ZB2BE101C	1NO	1	YE00210103100	(1)(4)	
38	S4,S5	安全开关/Safety switch	SCHMERSRC	AZ16-02ZVRK-1476	230VAC	2	YE16147600000	(1)(4)	
39	S4,S5	安全开关/Safety switch	SCHMERSRC	AZ15-02ZVRK-1476	230VAC	2	YE16147600100	(1)	
40	H2	三色警报灯/Alarm lamp	SHINI	红绿黄优先顺序+蜂鸣器	24VAC/DC 50/60Hz	1	BL90002401520	(1)	
41	H3	蜂鸣器/Buzzer	TEND	EA-2	24VAC	1	YE84240200000	(1)(3)	
42	MS	料位马达/Feed position motor	SHINI	SR-80	24VAC	1	YE15802400100	(1)(3)	
43	T	互感变压器/Transformer	----	IN=400V/415V OUT=24V	180VA	1	YE70040006700		
44	T	互感变压器/Transformer	----	IN=400V/415V OUT=24V	350VA	1	YE70040009900	(4)	
45	TA1	电流互感器/Current mutual inductance	RATIO	RQT-35	100/5A	1	YE04100500000		
46	PA	电流表/Galvanometry	SFIM	DH-670	100/5A	1	YE25671000000	(1)	
47	PCB	微电脑板/PCB	YUYUN	AB-02	24VAC	1	YE80022400100		
48		塑膠外殼SI-4T線路板用	----	----	----	1	YR40000400100		
49	TA2	电流互感器/Current mutual inductance	YUYUN	----	5-100A	1	----	线路板自带	
50	X1	端子排/Terminal	Honeywell	GK16PE	16mm ² PE	1	YE60001603500		
机型版本 Ver.D		注: (1)表示非电控箱内材料; (2)表示除尘风机选配件; (3)表示满料报警装置选配件; (4)表示安全继电器选配件; (5)表示皮带输送机选配件; (6)表示送料风机选配件; (7)表示大功率送料风机选配件。 (F1)							
D			制图	版号	F	标题	图号	比例	第 11 张
			设计	核准		SG-4360BH	SG-4360B(H)-GB-400V-F-11	标准 GB	共 12 张
	(F1)	标准CE	标准GB	校对		 信易電熱機械股份有限公司 Shini Plastics Technologies, Inc.	机器电压	3φ400V	
	标记	更改前	更改后	更改人	日期		20220805	机器频率	50Hz
1	2	3	4	5	6	7	8		

1	2	3	4	5	6	7	8	
序号/NO	符号/Symbol	名称/Name	制造商/Manufacturer	型号/Type	规格/Specification	数量/Number	物料编号/Material number	备注/Remark
51	X2	端子排/Terminal	Honeywell	GK10	10mm ²	6	YE60001003200	
52		端子排/Terminal	Honeywell	GK10PE	10mm ² PE	1	YE60001003500	
53	X3	端子排/Terminal	Honeywell	SK2.5	2.5mm ²	16	YE60002503200	
54			Honeywell	SK2.5	2.5mm ²	5	YE60002503200	(6)
55			Honeywell	GK2.5PE	2.5mm ² PE	1	YE60002503400	(6)/(7)
56			Honeywell	SK2.5	2.5mm ²	5	YE60002503200	(2)
57			Honeywell	GK2.5PE	2.5mm ² PE	1	YE60002503400	(2)
58			Honeywell	SK2.5	2.5mm ²	4	YE60002503200	(3)
59			Honeywell	SK2.5	2.5mm ²	2	YE60002503200	(5)
60			Honeywell	SK2.5	2.5mm ²	8	YE60002503200	(4)
61			Honeywell	SK6	6mm ²	3	YE60000603200	(7)
62			Honeywell	SK6PE	6mm ² PE	1	YE60000603500	(7)
63		终端固定件E/GX系列	Honeywell	----	PCS	4	YE60000003900	
64	X4	金属接头/Metal tie in	SHINI	PLT-162-RR(公)	2P	1	YE68016200100	(1)(5)
65	X10	金属接头/Metal tie in	SHINI	PLT-254-PM	4P	1	YE68025400000	(1)(3)
66		金属接头/Metal tie in	----	PLT-254-RF	4P	1	YE68025400100	(1)(3)
67	X11	重载接插件/Heavy duty connector	HARTING	16P+PE(公插+母座)	16P	1	YE68001601300	(1)
68	M1	粉碎电机/Granulating motor	SIEMENS	----	400V 50Hz 37kW	1	----	(1)
69	M2	送料风机/Solution blower	----	----	400V 50Hz 3kW	1	----	(1)(6)
70	M2	送料风机/Solution blower	----	----	400V 50Hz 7.5kW	1	----	(1)(7)
71	M3	除尘风机/Dust blower	----	----	400V 50Hz 0.75kW	1	----	(1)(2)
机型版本 Ver.D		注: (1)表示非电控箱内材料; (2)表示除尘风机选配件; (3)表示满料报警装置选配件; (4)表示安全继电器选配件; (5)表示皮带输送机选配件; (6)表示送料风机选配件; (7)表示大功率送料风机选配件。 (F1)						
			制图	版号 F	标题 SG-4360BH	图号	比例	第 12 张
			设计	核准	电气元件明细三	SG-4360B(H)-GB-400V-F-12	标准 GB	共 12 张
(F1)	标准CE	标准GB	校对	核准		信易電熱機械股份有限公司 Shini Plastics Technologies, Inc.	机器电压	3φ400V
标记	更改前	更改后	更改人	日期			日期 20220805	机器频率
1	2	3	4	5	6	7	8	

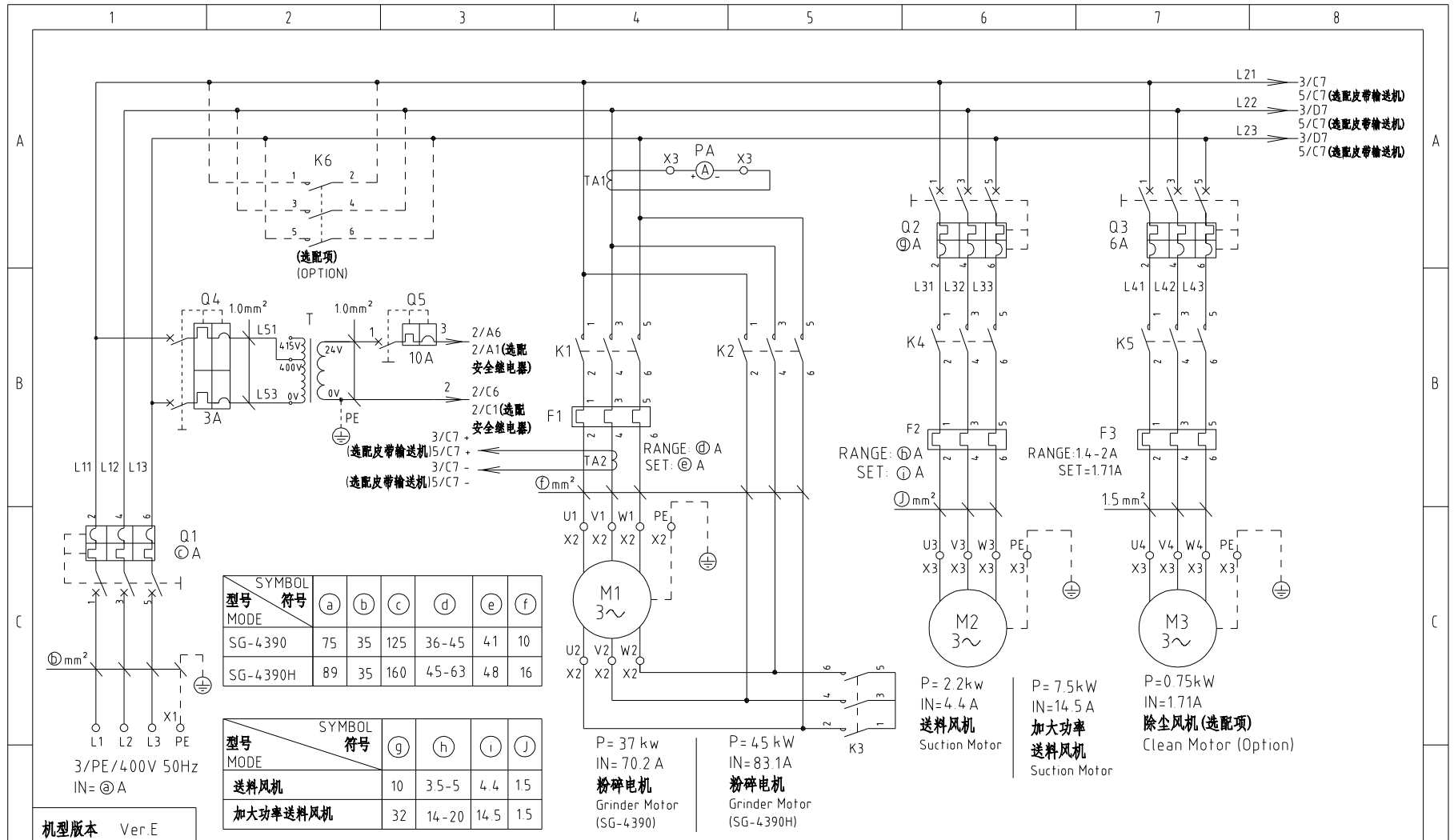

SYMBOL		符号					
型号	MODE	(a)	(b)	(c)	(d)	(e)	(f)
SG-4390		75	35	125	36-45	41	10
SG-4390H		89	35	160	45-63	48	16

SYMBOL		符号			
型号	MODE	(g)	(h)	(i)	(j)
送料风机		10	3.5-5	4.4	1.5
加大功率送料风机		32	14-20	14.5	1.5

机型版本 Ver.E

制图			版号		M	标题		SG-4390(H)		图号		SG-4390(H)-CE-400V-M-1		比例		第 1 张	
设计			核准			主电路图				标准		CE		共 12 张			
校对			日期		20220805	SHINI		信易電熱機械股份有限公司		Shini Plastics Technologies, Inc.		机器电压		3φ400V			
标记			更改前									机器频率		50Hz			

- L21 → 3/C7
- L22 → 5/C7 (选配皮带输送机)
- L23 → 3/D7
- L24 → 5/C7 (选配皮带输送机)
- L25 → 3/D7
- L26 → 5/C7 (选配皮带输送机)

- P= 2.2kW
IN=4.4 A
送料风机
Suction Motor
- P= 7.5kW
IN=14.5 A
加大功率
送料风机
Suction Motor
- P=0.75kW
IN=1.71A
除尘风机 (选配)
Clean Motor (Option)

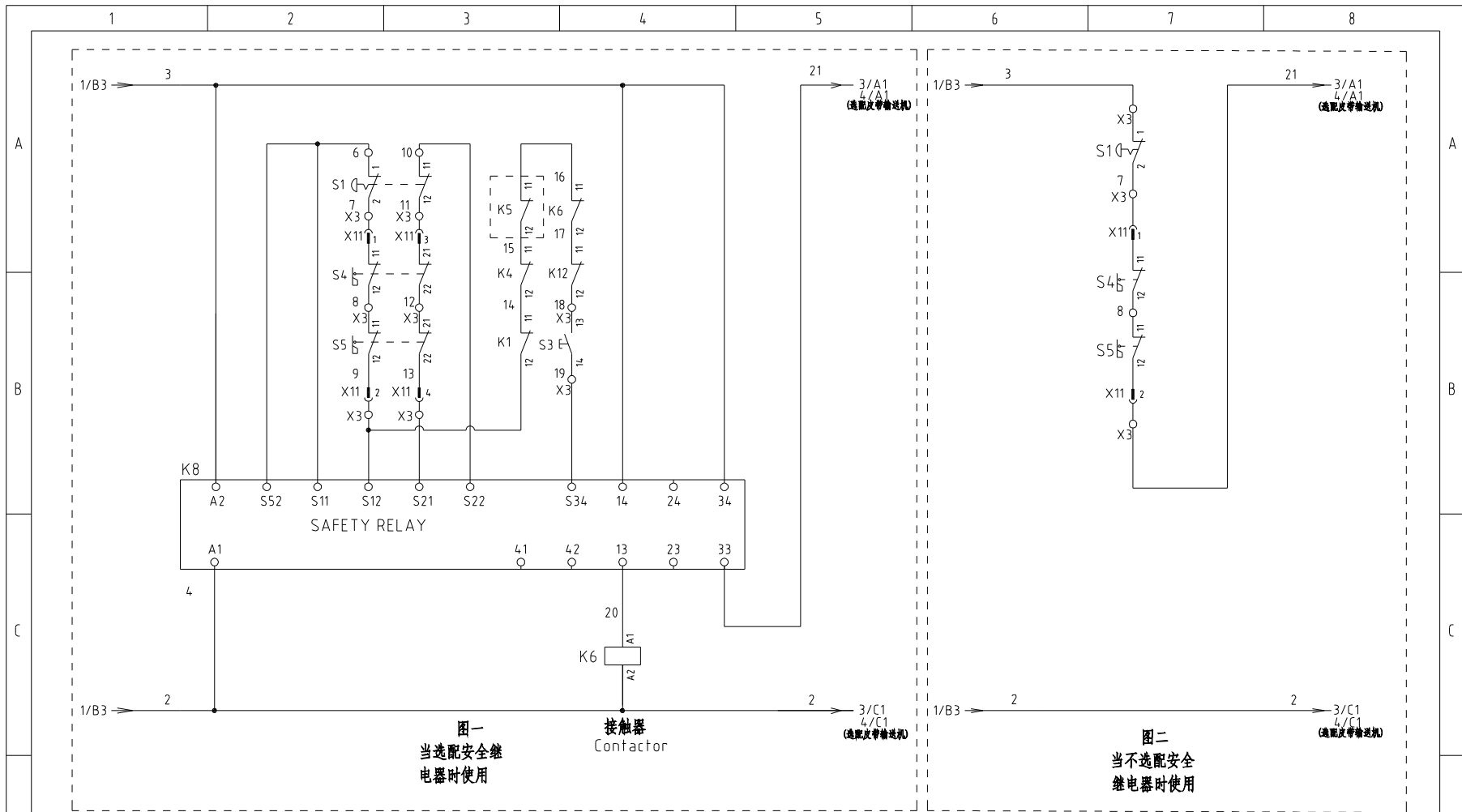

机型版本 Ver.E

				制图		版号	M
				设计		核准	
				校对		核准	
标记	更改前	更改后	更改人	日期	审核	日期	20220805

标题 SG-4390(H)
控制电路图一

图号 SG-4390(H)-CE-400V-M-2

比例 第 2 张
标准 CE 共 12 张



信易電熱機械股份有限公司
Shini Plastics Technologies, Inc.

机器电压 3φ400V
机器频率 50Hz

1

2

3

4

5

6

7

8

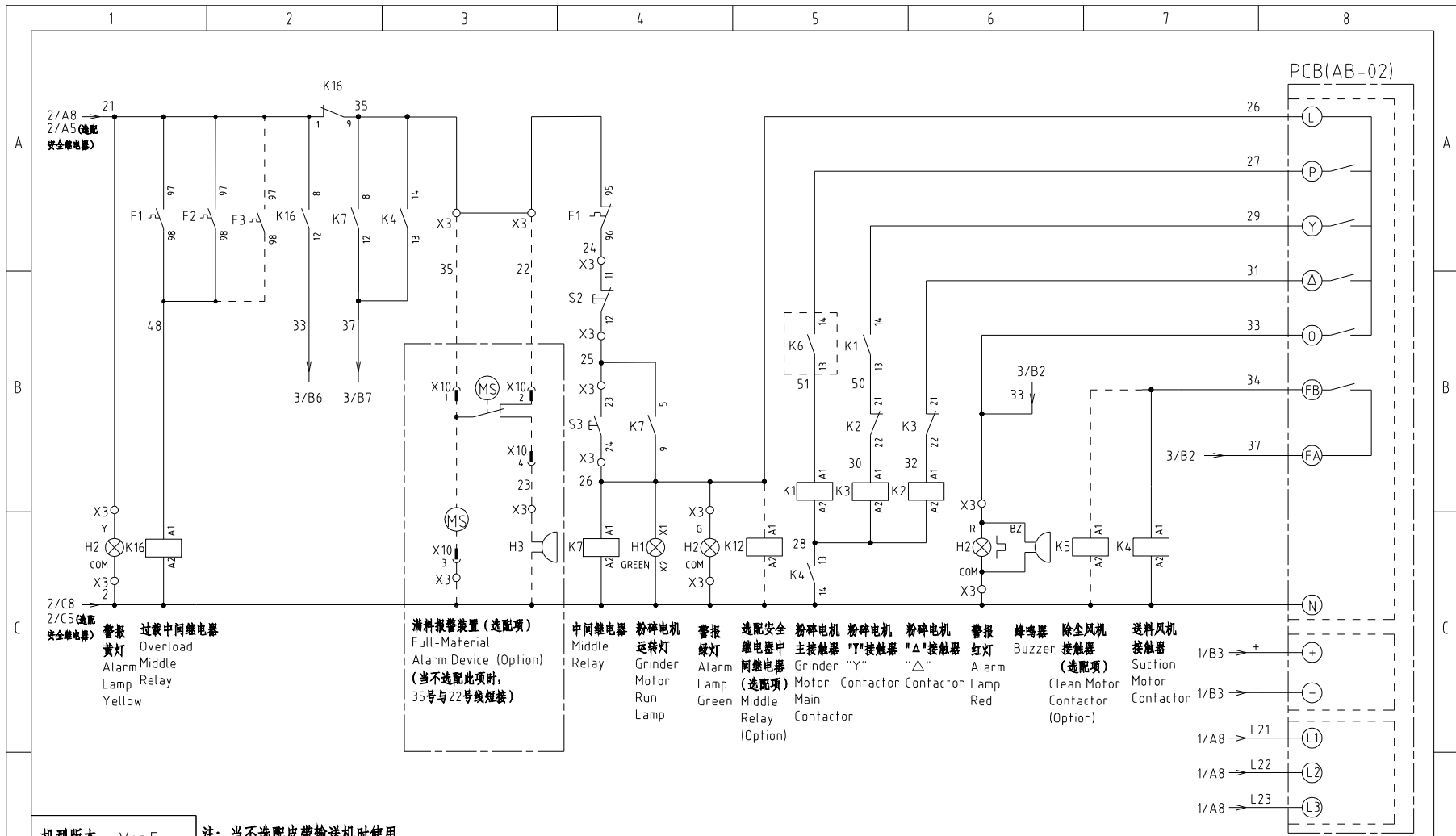

2/C8
2/C5 (选配
安全继电器)

警报
黄灯
Alarm
Lamp
Yellow

过载中间继电器
Overload
Middle
Relay

送料报警装置 (选选项)
Full-Material
Alarm Device (Option)
(当不选配此项时,
35号与22号线短接)

中间继电器
Middle
Relay

粉碎机
运转灯
Grinder
Motor
Run
Lamp

警报
绿灯
Alarm
Lamp
Green

选配安全
继电器中
间继电器
安全继电器
(选选项)
Middle
Relay
Relay
(Option)

粉碎机
主接触器
Grinder
Main
Contactor
(Option)

粉碎机
"Y"接触器
Grinder
"Y"
Contactor

粉碎机
"Δ"接触器
Grinder
"Δ"
Contactor

警报
红灯
Alarm
Lamp
Red

蜂鸣器
Buzzer

除尘风机
接触器
(选选项)
Clean Motor
Contactor
(Option)

送料风机
接触器
Suction
Motor
Contactor

机型版本 Ver.E 注: 当不选配皮带输送机时使用。

制图		版号		M		标题		SG-4390(H) 控制电路图二		图号		SG-4390(H)-CE-400V-M-3		比例		第 3 张	
设计		核准										标准		CE		共 12 张	
校核		日期		20220805		SHINI		信易电热机械股份有限公司 Shini Plastics Technologies, Inc.		机器电压		3φ400V		机器频率		50Hz	
1	2	3	4	5	6	7	8										

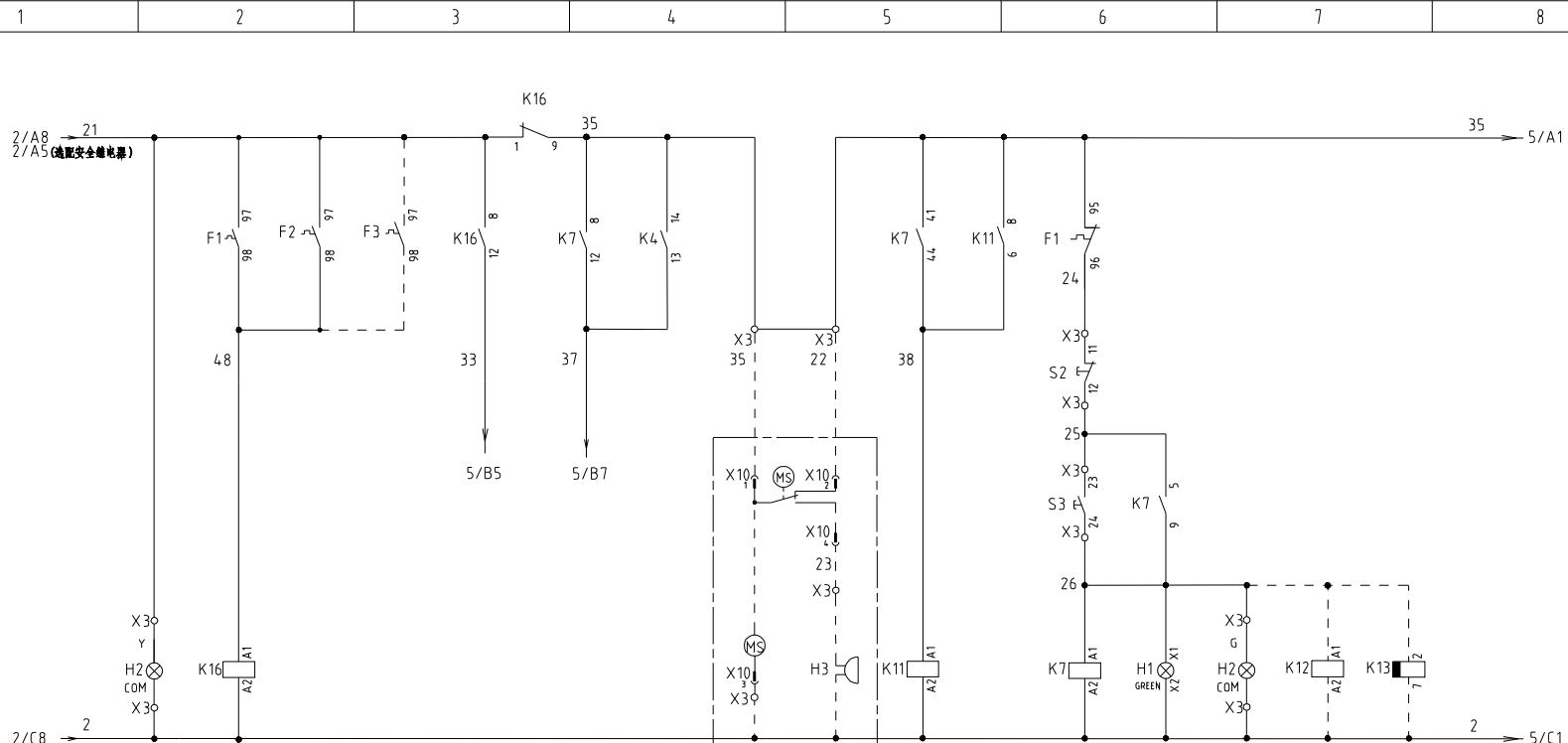

报警
黄灯
Alarm
Lamp
Yellow

过载中间继电器
Overload
Middle
Relay

满料报警装置
(选配项)
Full-Material
Alarm Device
(Option)
(当不选配此项时,
35号与22号线短接)

皮带输送机
中间继电器
(选配项)
Belt
Conveyor
Middle
Relay
(Option)

中间继电器
Middle
Relay

粉碎电机
运转灯
Grinder
Motor
Run
Lamp

报警
绿灯
Alarm
Lamp
Green

选配安全
继电器中
间继电器
(选配项)
Middle
Relay
(Option)

主机延时
停机时
间继电器
(选配项)
Grinder
Motor
Delay
Stoppage
Time
Relay
(Option)

机型版本 Ver.E 注:当选配皮带输送机时使用。

制图		版号		M	标题		图号		比例	第 4 张	
设计		核准			SG-4390(H) 控制电路图三		SG-4390(H)-CE-400V-M-4		标准	CE 共 12 张	
校对		日期		20220805	 信易电热机械股份有限公司 Shini Plastics Technologies, Inc.		机器电压		3φ400V		
标记		更改前		更改后			更改人		日期		机器频率
1		2		3		4		5		8	

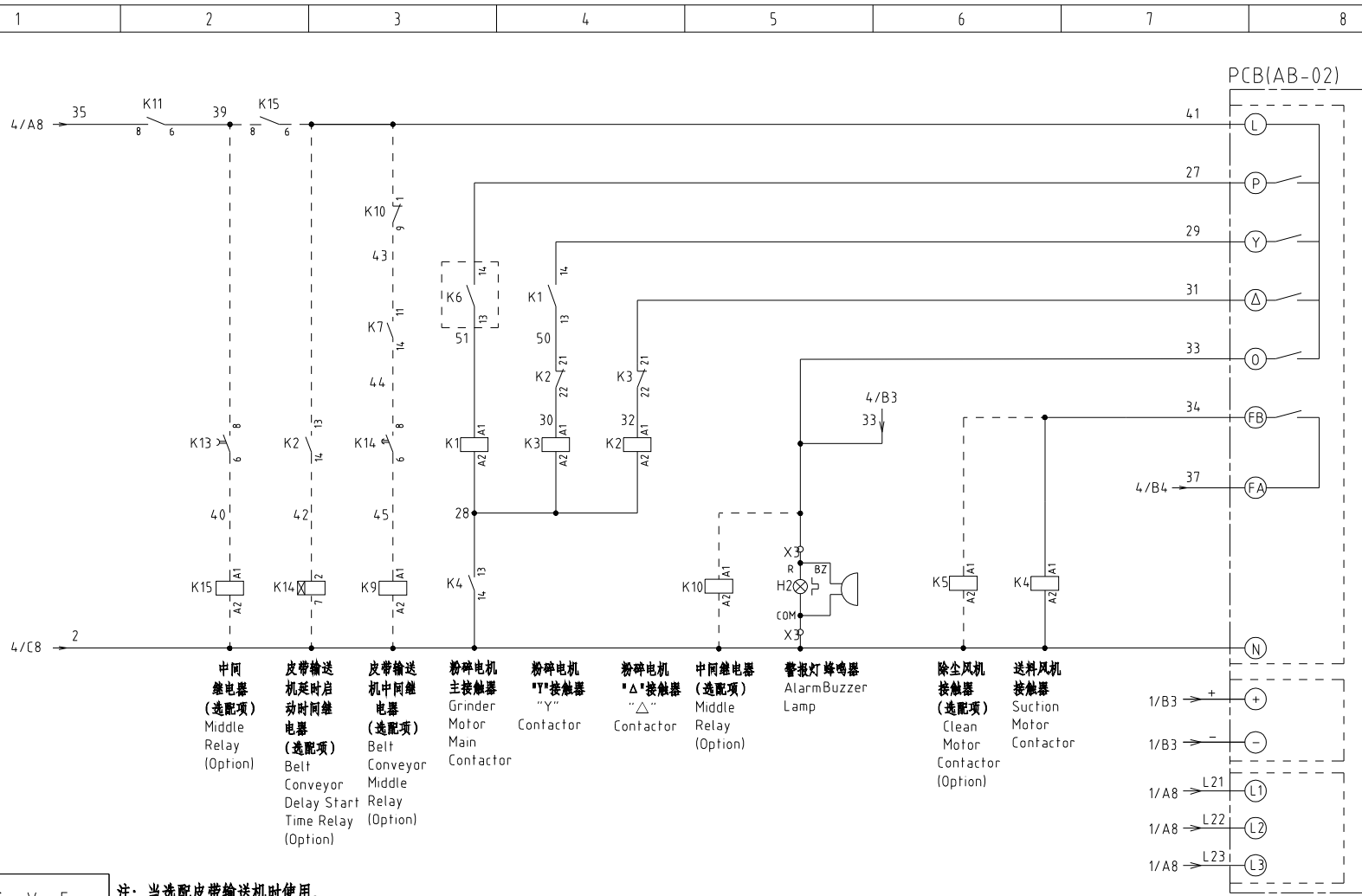

机型版本 Ver E 注: 当选配皮带输送机时使用。

制图		版号 M		标题 SG-4390(H) 控制电路图三		图号 SG-4390(H)-CE-400V-M-5		比例 第 5 张	
设计		核准		SHINI 信易電熱機械股份有限公司 Shini Plastics Technologies, Inc.		标准 CE		共 12 张	
校对		日期 20220805		机器电压 3φ400V		机器频率 50Hz			
标记	更改前	更改后	更改人	日期	审核	日期	20220805		

选配皮带输送机控制触点接线示意图

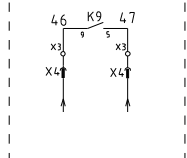

X4金属接头接线示意图
接皮带输送机
(选配项)

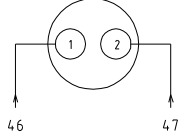

X10金属接头接线示意图
接满料报警装置
(选配项)

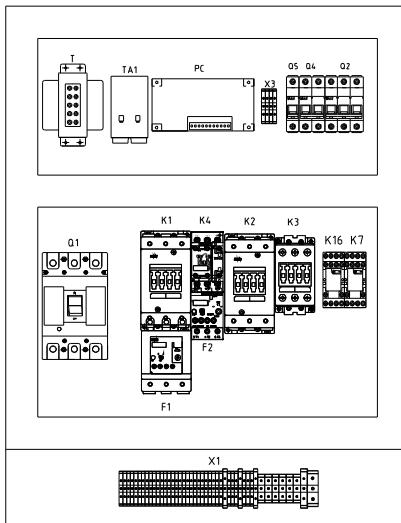
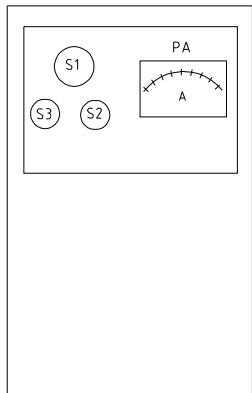
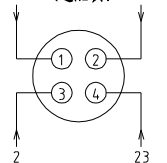

标准机型布局图

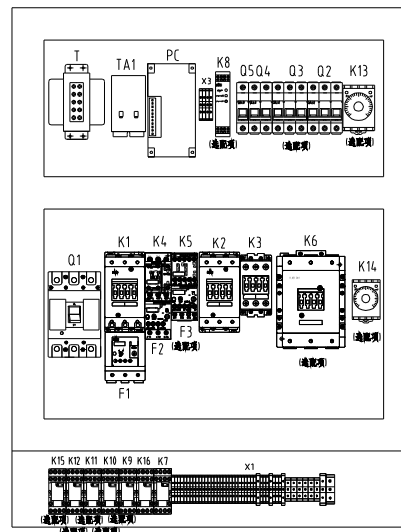

选配机型布局图

X11: 16P 重载接插件

①	7	⑨	
②	9	⑩	
③	11	⑪	
④	13	⑫	
⑤		⑬	
⑥		⑭	
⑦		⑮	
⑧		⑯	

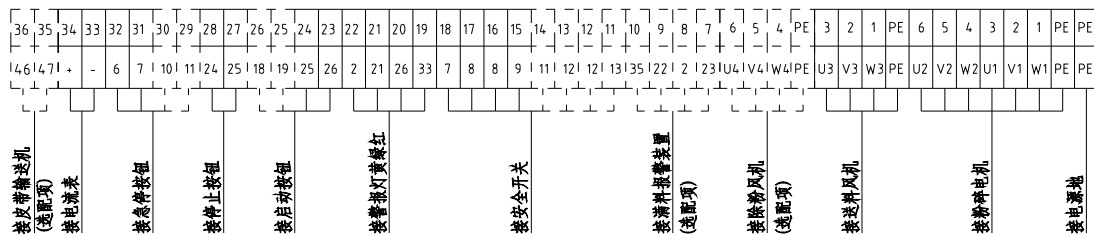

注: 当不选配安全继电器时将9号端子改为21号, 11号端子和13号端子不用接

机型版本 Ver.E 注: 当不选配安全继电器时将6号端子改为3号, 9号端子改为21号。

制图		版号		M	标题		图号		比例		第 6 张	
设计		核准			SG-4390(H) 电气元件布置图		SG-4390(H)-CE-400V-M-6		标准		CE 共 12 张	
校对		日期		20220805	信易電熱機械股份有限公司 Shini Plastics Technologies, Inc.		机器电压		3Φ400V			
标记		更改前		更改后			更改人		机器频率		50Hz	

1 2 3 4 5 6 7 8

1		2		3		4		5		6		7		8	
序号/NO	符号/Symbol	名称/Name		制造商/Manufacturer	型号/Type		规格/Specification		数量/Number	物料编号/Material number		备注/Remark			
1	Q1	门连锁断路器/Gate circuit breaker		TECO	TAX-125L3125 3P		125A		1	YE40125301100					
2		断路器外部操作把手/External operating handle		TECO	FB1R-CS1-C-D1 (TAX-125)		----		1	YE90111100300					
3	Q2	断路器/Circuit-breaker		TECO	BM-63C/3P		10A		1	YE40301003000					
4	Q2	断路器/Circuit-breaker		TECO	BM-63C/3P		32A		1	YE40303203000		(6)			
5	Q3	断路器/Circuit-breaker		TECO	BM-63C/3P		6A		1	YE40300603000		(2)			
6	Q4	断路器/Circuit-breaker		TECO	BM-63C/2003S 2P		3A		1	YE40200203000					
7	Q5	断路器/Circuit-breaker		TECO	BM-63C/1010S 1P		10A		1	YE40101000100					
8	K1,K2	接触器/Contactor		SIEMENS	3RT5036-1AC20		50A 24 VAC 50/60Hz		2	YE00503602600					
9		辅助触点/Auxiliary Contactor		SIEMENS	3RH5921-1CA10		1NO		1	YE00592110000					
10	K3	接触器/Contactor		SIEMENS	3RT5035-1AC20		40A 24 VAC 50/60Hz		1	YE00503502600					
11		辅助触点/Auxiliary Contactor		SIEMENS	3RH5921-1CA01		1NC		2	YE00592110100					
12		辅助触点/Auxiliary Contactor		SIEMENS	3RH5921-1CA10		1NO		1	YE00592110000		(5)			
13		辅助触点/Auxiliary Contactor		SIEMENS	3RH5921-1CA01		1NC		1	YE00592110100		(4)			
14	K4	接触器/Contactor		SIEMENS	3RT6016-1AB01		9A 24 VAC 50/60Hz		1	YE00601602500					
15	K4	接触器/Contactor		SIEMENS	3RT6026-1AB01		25A 24 VAC 50/60Hz		1	YE00602602600		(6)			
16		辅助触点/Auxiliary Contactor		SIEMENS	3RH6911-1HA11		1NC+1NO		1	YE00691100100					
17	K5	接触器/Contactor		SIEMENS	3RT6016-1AB02		9A 24 VAC 50/60Hz		1	YE00601602600		(2)			
18	K6	接触器/Contactor		SIEMENS	3RT5046-1AC20		95A 24 VAC 50/60Hz		1	YE00504602600		(4)			
19		辅助触点/Auxiliary Contactor		SIEMENS	3RH5921-1CA01		1NC		1	YE00592110100		(4)			
20		辅助触点/Subsidiary Contactor		SIEMENS	3RH5921-1CA10		1NO		1	YE00592110000		(4)			
21	K7	中间继电器/Middle relay		Honeywell	GR-2C-AC24V		24 VAC		1	YE03022400300					
22	K7	中间继电器/Middle relay		Honeywell	GR-4C-AC24V		24 VAC		1	YE03042400300		(5)			
23	K8	安全继电器/Safety relay		PILZ	PNOZ×2.8P		24V AC/DC		1	YE04023000000		(4)			
24	K9 K10 K11 K15	中间继电器/Middle relay		Honeywell	GR-2C-AC24V		24 VAC		4	YE03022400300		(5)			
25	K12	中间继电器/Middle relay		Honeywell	GR-2C-AC24V		24 VAC		1	YE03022400300		(4)			
机型版本 Ver.E		注: (1)表示非电控箱内材料; (2)表示除尘风机选配件; (3)表示满料报警装置选配件; (4)表示安全继电器选配件; (5)表示皮带输送机选配件; (6)表示加大风机功率选配件。													
D				制图		版号 M		标题 SG-4390		图号 SG-4390(H)-CE-400V-M-7		比例		第 7 张	
				设计		核准		电气元件明细一				标准 CE		共 12 张	
				校对						信易電熱機械股份有限公司 Shini Plastics Technologies, Inc.		机器电压		3φ400V	
标记		更改前		更改后		更改人						日期		20220805	
1		2		3		4		5		6		7		8	

1		2		3		4		5		6		7		8	
序号/NO	符号/Symbol	名称/Name		制造商/Manufacturer	型号/Type		规格/Specification		数量/Number	物料编号/Material number		备注/Remark			
26	K13	定时器/Timer		YUYUN	TRF-N/3M		24VAC		1	YE86032400000		(5)			
27	K14	定时器/Timer		YUYUN	TH3A-NAB 60S		24VAC		1	YE86602400300		(5)			
28	F1	热过载继电器/Overload relay		SIEMENS	3RU5136-4GB0		36-45A		1	YE01612660000					
29	F2	热过载继电器/Overload relay		SIEMENS	3RU6116-1FB0		3.5-5A		1	YE01160350000					
30	F2	热过载继电器/Overload relay		SIEMENS	3RU6126-4BB0		14-20A		1	YE01260140000		(6)			
31	F3	热过载继电器/Overload relay		SIEMENS	3RU6116-1BB0		1.4-2A		1	YE01160140000		(2)			
32	K16	中间继电器/Middle relay		Honeywell	GR-2C-AC24V		24VAC		1	YE03022400300					
33	S1	急停按钮/Emergency stop button		SCHNEIDER	XB2BS542C		400VAC		1	YE11254200000		(1)			
34		触点块/Contact block		SCHNEIDER	ZB2BE102C		1NC		1	YE00210203100		(1)(4)			
35	S2	停止按钮/Stop button		SCHNEIDER	XB2BA22C		400VAC		1	YE11222000000		(1)			
36	S3,H1	启动按钮(带灯)/Start button		SCHNEIDER	XB2BW33B1C		24VAC		1	YE11233100000		(1)			
37		触点块/Contact block		SCHNEIDER	ZB2BE101C		1NO		1	YE00210103100		(1)(4)			
38	S4,S5	安全开关/Safety switch		SCHMERSRC	AZ16-02ZVRK-1476		230VAC		2	YE16147600000		(1)(4)			
39	S4,S5	安全开关/Safety switch		SCHMERSRC	AZ15-02ZVRK-1476		230VAC		2	YE16147600100		(1)			
40	H2	三色警报灯/Alarm lamp		SHINI	红绿黄优先顺序+蜂鸣器		24VAC/DC 50/60Hz		1	BL90002401520		(1)			
41	H3	蜂鸣器/Buzzer		TEND	EA-2		24VAC		1	YE84240200000		(1)(3)			
42	MS	料位马达/Feed position motor		SHINI	SR-80		24VAC		1	YE15802400100		(1)(3)			
43	T	互感变压器/Transformer		----	IN=400V/415V OUT=24V		180VA		1	YE70040006700					
44	T	互感变压器/Transformer		----	IN=400V/415V OUT=24V		350VA		1	YE70040009900		(4)			
45	TA1	电流互感器/Current mutual inductance		RATIO	RQT-35		100/5A		1	YE04100500000					
46	PA	电流表/Galvanometry		SFIM	DH-670		100/5A		1	YE25671000000		(1)			
47	PCB	微电脑板/PCB		YUYUN	AB-02		24VAC		1	YE80022400100					
48		塑膠外殼SI-4T線路板用		----	----		----		1	YR40000400100					
49	TA2	电流互感器/Current mutual inductance		YUYUN	----		5-100A		1	----		线路板自带			
50	X1	端子排/Terminal		Honeywell	GK16PE		16mm ² PE		1	YE60001603500					
机型版本 Ver.E		注: (1)表示非电控箱内材料; (2)表示除尘风机选配件; (3)表示满料报警装置选配件; (4)表示安全继电器选配件; (5)表示皮带输送机选配件; (6)表示加大风机功率选配件。													
D					制图		版号	M	标题	SG-4390	图号	比例	第 8 张		
					设计		核		电气元件明细二	SG-4390(H)-CE-400V-M-8	标准	CE	共 12 张		
					校对		准		 信易電熱機械股份有限公司 Shini Plastics Technologies, Inc.	机器电压	3φ400V				
	标记	更改前	更改后	更改人	日期	审核	日期	20220805		机器频率	50Hz				
1		2		3		4		5		6		7		8	

1	2	3	4	5	6	7	8	
序号/NO	符号/Symbol	名称/Name	制造商/Manufacturer	型号/Type	规格/Specification	数量/Number	物料编号/Material number	备注/Remark
51	X2	端子排/Terminal	Honeywell	GK10	10mm ²	6	YE60001003200	
52		端子排/Terminal	Honeywell	GK10PE	10mm ² PE	1	YE60001003500	
53	X3	端子排/Terminal	Honeywell	SK2.5	2.5mm ²	21	YE60002503200	
54			Honeywell	GK2.5PE	2.5mm ² PE	1	YE60002503400	
55			Honeywell	SK2.5	2.5mm ²	4	YE60002503200	(2)
56			Honeywell	GK2.5PE	2.5mm ² PE	1	YE60002503400	(2)
57			Honeywell	SK2.5	2.5mm ²	4	YE60002503200	(3)
58			Honeywell	SK2.5	2.5mm ²	2	YE60002503200	(5)
59			Honeywell	SK2.5	2.5mm ²	8	YE60002503200	(4)
60			Honeywell	SK6	6mm ²	3	YE60000603200	(6)
61			Honeywell	SK6PE	6mm ² PE	1	YE60000603500	(6)
62		终端固定件B/GX系列	Honeywell	----	PCS	4	YE60000003900	
63	X4	金属接头/Metal tie in	SHINI	PLT-162-RR(公)	2P	1	YE68016200100	(1)(5)
64	X10	金属接头/Metal tie in	SHINI	PLT-254-PM	4P	1	YE68025400000	(1)(3)
65		金属接头/Metal tie in	----	PLT-254-RF	4P	1	YE68025400100	(1)(3)
66	X11	重载插件件/Heavy duty connector	HARTING	16P+PE(公插+母座)	16P	1	YE68001601300	(1)
67	M1	粉碎电机/Granulating motor	----	----	400V 50Hz 37kW	1	----	(1)
68	M2	送料风车/Solution blower	----	----	400V 50Hz 2.2kW	1	----	(1)
69	M2	送料风车/Solution blower	----	----	400V 50Hz 7.5kW	1	----	(1)(6)
70	M3	除尘风车/Dust blower	----	----	400V 50Hz 0.75kW	1	----	(1)(2)
机型版本 Ver.E		注: (1)表示非电控箱内材料; (2)表示除尘风机选配件; (3)表示满料报警装置选配件; (4)表示安全继电器选配件; (5)表示皮带输送机选配件; (6)表示加大风机功率选配件。						
			制图	版号 M	标题 SG-4390	图号 SG-4390(H)-CE-400V-M-9	比例	第 9 张
			设计	核准	电气元件明细三		标准 CE	共 12 张
			校对			信易電熱機械股份有限公司 Shini Plastics Technologies, Inc.	机器电压	3φ400V
标记	更改前	更改后	更改人	日期			20220805	机器频率
1	2	3	4	5	6	7	8	

1		2		3		4		5		6		7		8	
序号/NO	符号/Symbol	名称/Name		制造商/Manufacturer	型号/Type		规格/Specification		数量/Number	物料编号/Material number		备注/Remark			
A	1	Q1	门连锁断路器/Gate Circuit-breaker		TECO	TAX-250L3160 3P		160A		1	YE40250300400				
	2		断路器外部操作把手/External operating handle		TECO	FB1R-CS1-C-D1(TAX-250)		----		1	YE90211200300				
	3	Q2	断路器/Circuit-breaker		TECO	BM-63C/3P		10A		1	YE40301003000				
	4	Q2	断路器/Circuit-breaker		TECO	BM-63C/3P		32A		1	YE40303203000		(6)		
	5	Q3	断路器/Circuit-breaker		TECO	BM-63C/3P		6A		1	YE40300603000		(2)		
	6	Q4	断路器/Circuit-breaker		TECO	BM-63C/2003S 2P		3A		1	YE40200203000				
	7	Q5	断路器/Circuit-breaker		TECO	BM-63C/1010S 1P		10A		1	YE40101000100				
B	8	K1,K2	接触器/Contactor		SIEMENS	3RT5044-1AC20		65A 24 VAC 50/60Hz		2	YE00504402600				
	9		辅助触点/Auxiliary Contactor		SIEMENS	3RH5921-1CA10		1NO		1	YE00592110000				
	10	K3	接触器/Contactor		SIEMENS	3RT5036-1AC20		50A 24 VAC 50/60Hz		1	YE00503602600				
	11		辅助触点/Auxiliary Contactor		SIEMENS	3RH5921-1CA01		1NC		2	YE00592110100				
	12		辅助触点/Auxiliary Contactor		SIEMENS	3RH5921-1CA10		1NO		1	YE00592110000		(5)		
	13	K4	接触器/Contactor		SIEMENS	3RT6016-1AB01		9A 24 VAC 50/60Hz		1	YE00601602500				
	14	K4	接触器/Contactor		SIEMENS	3RT6026-1AC20		25A 24 VAC 50/60Hz		1	YE00602602600		(6)		
C	15		辅助触点/Auxiliary Contactor		SIEMENS	3RH6911-1HA11		1NC+1NO		1	YE00691100100				
	16	K5	接触器/Contactor		SIEMENS	3RT6016-1AB02		9A 24 VAC 50/60Hz		1	YE00601602600		(2)		
	17	K6	接触器/Contactor		SIEMENS	3RT5054-1AB36		115A 24 V 50/60Hz		1	YE00505400900		(4)		
	18		辅助触点/Auxiliary Contactor		SIEMENS	3RH5921-1CA01		1NC		1	YE00592110100		(4)		
	19		辅助触点/Subsidiary Contactor		SIEMENS	3RH5921-1CA10		1NO		1	YE00592110000		(4)		
	20	K7	中间继电器/Middle relay		Honeywell	GR-2C-AC24V		24 VAC		1	YE03022400300				
	21	K7	中间继电器/Middle relay		Honeywell	GR-4C-AC24V		24 VAC		1	YE03042400300		(5)		
D	22	K8	安全继电器/Safety relay		PILZ	PNOZ×2.8P		24V AC/DC		1	YE04023000000		(4)		
	23	K9 K10 K11 K15	中间继电器/Middle relay		Honeywell	GR-2C-AC24V		24 VAC		4	YE03022400300		(5)		
	24	K12	中间继电器/Middle relay		Honeywell	GR-2C-AC24V		24 VAC		1	YE03022400300		(4)		
	25	K13	定时器/Timer		YUYUN	TRF-N/3M		24 VAC		1	YE86032400000		(5)		
	机型版本 Ver E		注: (1)表示非电控箱内材料; (2)表示除尘风机选配件; (3)表示满料报警装置选配件; (4)表示安全继电器选配件; (5)表示皮带输送机选配件; (6)表示加大风机功率选配件。												
				制图	版号 M		标题 SG-4390H		图号 SG-4390(H)-CE-400V-M-10		比例	第 10 张			
				设计	核 准		电气元件明细一				标准	CE 共 12 张			
				校对			 信易電熱機械股份有限公司 Shini Plastics Technologies, Inc.				机器电压	3φ400V			
标记	更改前	更改后	更改人	日期	审核	日期			20220805	机器频率	50Hz				
1		2		3		4		5		6		7		8	

1		2		3		4		5		6		7		8	
序号/NO	符号/Symbol	名称/Name		制造商/Manufacturer	型号/Type		规格/Specification		数量/Number	物料编号/Material number		备注/Remark			
A	26	K14	定时器/Timer		YUYUN	TH3A-NAB 60S		24VAC		1	YE86602400300		(5)		
	27	F1	热过载继电器/Overload relay		SIEMENS	3RU5146-4 JB0		45-63A		1	YE01514640000				
	28	F2	热过载继电器/Overload relay		SIEMENS	3RU6126-4BB0		14-20A		1	YE01260140000		(6)		
	29	F2	热过载继电器/Overload relay		SIEMENS	3RU6116-1FB0		3.5-5A		1	YE01160350000				
	30	F3	热过载继电器/Overload relay		SIEMENS	3RU6116-1BB0		1.4-2A		1	YE01160140000		(2)		
	31	K16	中间继电器/Middle relay		Honeywell	GR-2C-AC24V		24VAC		1	YE03022400300				
B	32	S1	急停按钮/Emergency stop button		SCHNEIDER	XB2BS542C		400VAC		1	YE11254200000		(1)		
	33		触点块/Contact block		SCHNEIDER	ZB2BE102C		1NC		1	YE00210203100		(1)(4)		
	34	S2	停止按钮/Stop button		SCHNEIDER	XB2BA22C		400VAC		1	YE11222000000		(1)		
	35	S3,H1	启动按钮(带灯)/Start button		SCHNEIDER	XB2BW33B1C		24VAC		1	YE11233100000		(1)		
	36		触点块/Contact block		SCHNEIDER	ZB2BE101C		1NO		1	YE00210103100		(1)(4)		
	37	S4,S5	安全开关/Safety switch		SCHMERSRC	AZ15-02ZVRK-1476		230VAC		2	YE16147600100		(1)		
C	38	S4,S5	安全开关/Safety switch		SCHMERSRC	AZ16-02ZVRK-1476		230VAC		2	YE16147600000		(1)(4)		
	39	H2	三色警报灯/Alarm lamp		SHINI	红绿黄优先顺序+蜂鸣器		24VAC/DC 50/60Hz		1	BL90002401520		(1)		
	40	H3	蜂鸣器/Buzzer		TEND	EA-2		24VAC		1	YE84240200000		(1)(3)		
	41	MS	料位马达/Feed position motor		SHINI	SR-80		24VAC		1	YE15802400100		(1)(3)		
	42	T	互感变压器/Transformer		----	IN=400V/415V OUT=24V		350VA		1	YE70040009900				
	43	TA1	电流互感器/Current mutual inductance		RATIO	RCT-35		150/5A		1	YE04150500000				
D	44	PA	电流表/Galvanometry		SFIM	DH-670		150/5A		1	YE25671500000		(1)		
	45	PCB	微电脑板/PCB		JIUXIN	AB-02		24VAC		1	YE80022400100				
	46		塑膠外壳SI-4T線路板用		----	----		----		1	YR40000400100				
	47	TA2	电流互感器/Current mutual inductance		YUYUN	----		5-100A		1	----		线路板自带		
	48	X1	端子排/Terminal		Honeywell	GK16PE		16mm ² PE		1	YE60001603500				
	49	X2	端子排/Terminal		Honeywell	GK16		16mm ²		6	YE60001603200				
50		端子排/Terminal		Honeywell	GK16PE		16mm ² PE		1	YE60001603500					
机型版本 Ver.E		注: (1)表示非电控箱内材料; (2)表示除尘风机选配件; (3)表示满料报警装置选配件; (4)表示安全继电器选配件; (5)表示皮带输送机选配件; (6)表示加大风机功率选配件。													
D					制图		版号	M	标题	SG-4390H	图号		比例		第 11 张
					设计		核		电气元件明细二		SG-4390(H)-CE-400V-M-11	标准	CE		共 12 张
					校对		准			信易電熱機械股份有限公司		机器电压	3φ400V		
	标记	更改前	更改后	更改人	日期	审核	日期	20220805		Shini Plastics Technologies, Inc.		机器频率	50Hz		
1		2		3		4		5		6		7		8	

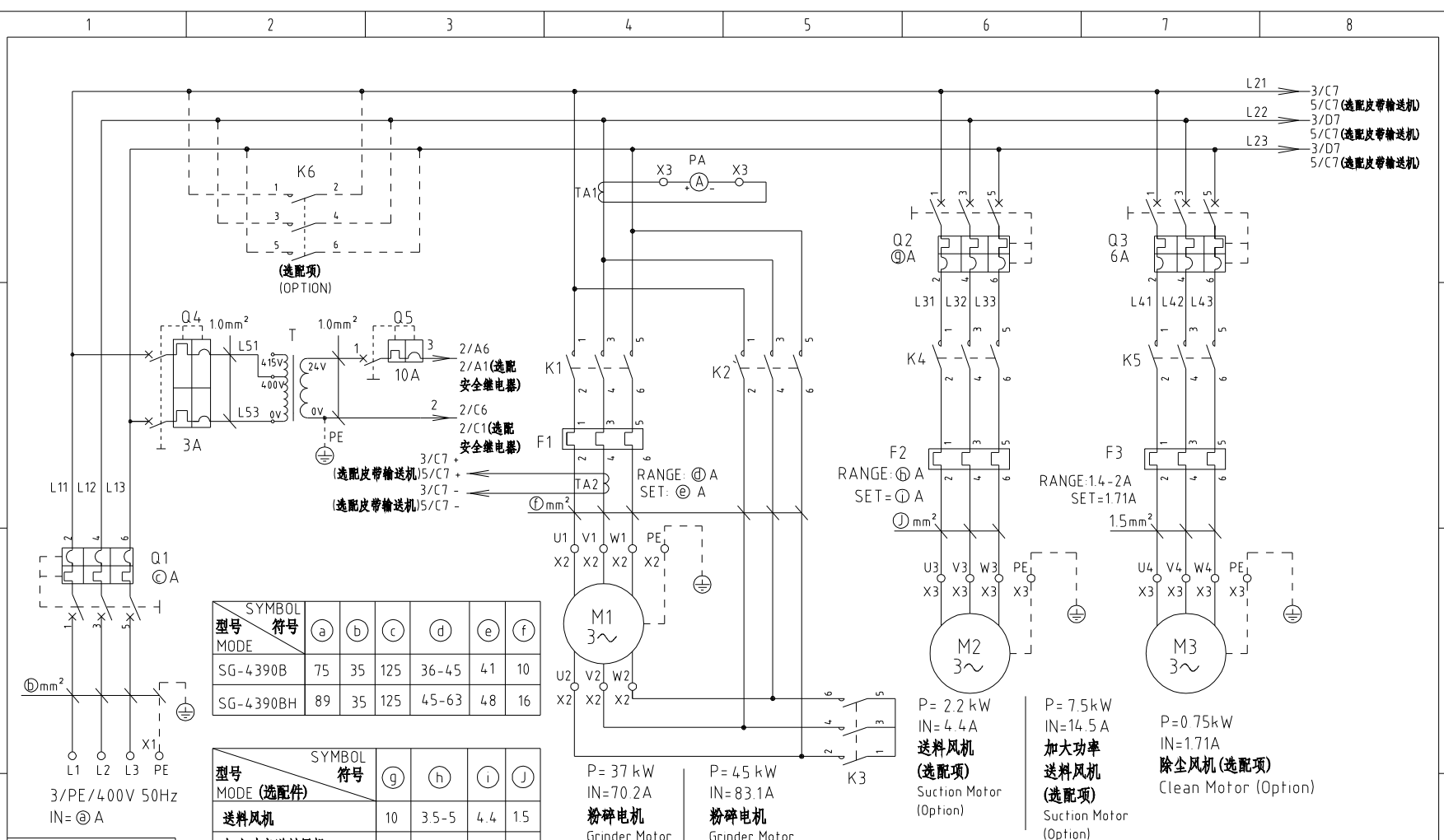

SYMBOL	符号	a	b	c	d	e	f
型号							
MODE							
SG-4390B		75	35	125	36-45	41	10
SG-4390BH		89	35	125	45-63	48	16

SYMBOL	符号	g	h	i	j
型号					
MODE (选配件)					
送料风机		10	3.5-5	4.4	1.5
加大功率送料风机		32	14-20	14.5	15

P= 37 kW
IN=70.2A
粉碎电机
Grinder Motor
(SG-4390B)

P= 4.5 kW
IN=83.1A
粉碎电机
Grinder Motor
(4390BH)

P= 2.2 kW
IN= 4.4 A
送料风机
(选配件)
Suction Motor
(Option)

P= 7.5 kW
IN=14.5 A
加大功率
送料风机
(选配件)
Suction Motor
(Option)

P=0.75 kW
IN=1.71 A
除尘风机 (选配件)
Clean Motor (Option)

机型版本 Ver.D

制图		版号		标题		图号		比例		第 1 张	
设计		核准		SG-4390(H)		SG-4390(H)-GB-400V-F-1		标准		GB	
校对		日期		主电路图				机器电压		3φ400V	
更改前		更改后		日期		20220805		机器频率		50Hz	
更改人		日期		日期		20220805					



信易電熱機械股份有限公司
Shini Plastics Technologies, Inc.

(F1)

标记

1 2 3 4 5 6 7 8

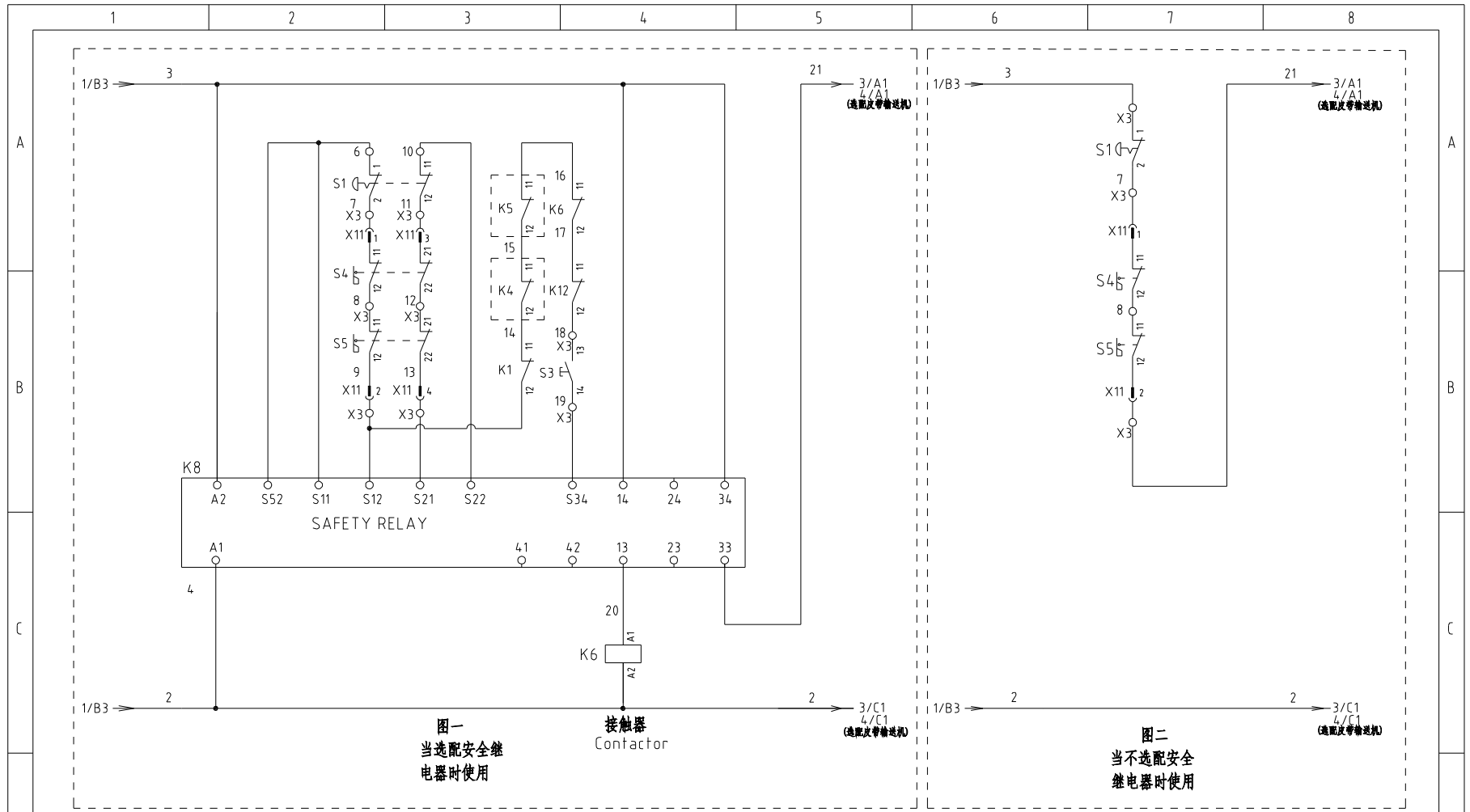

图一
当选配安全继电器时使用

图二
当不选配安全继电器时使用

机型版本 Ver.D

(F1)

制图		版号		标题		图号		比例		第 2 张	
设计		核准		SG-4390B(H) 控制电路图一		SG-4390B(H)-GB-400V-F-2		标准 GB		共 12 张	
校对		日期		SHINI 信易電熱機械股份有限公司 Shini Plastics Technologies, Inc.		机器电压		3φ400V			
审核		日期		20220805		机器频率		50Hz			

1 2 3 4 5 6 7 8

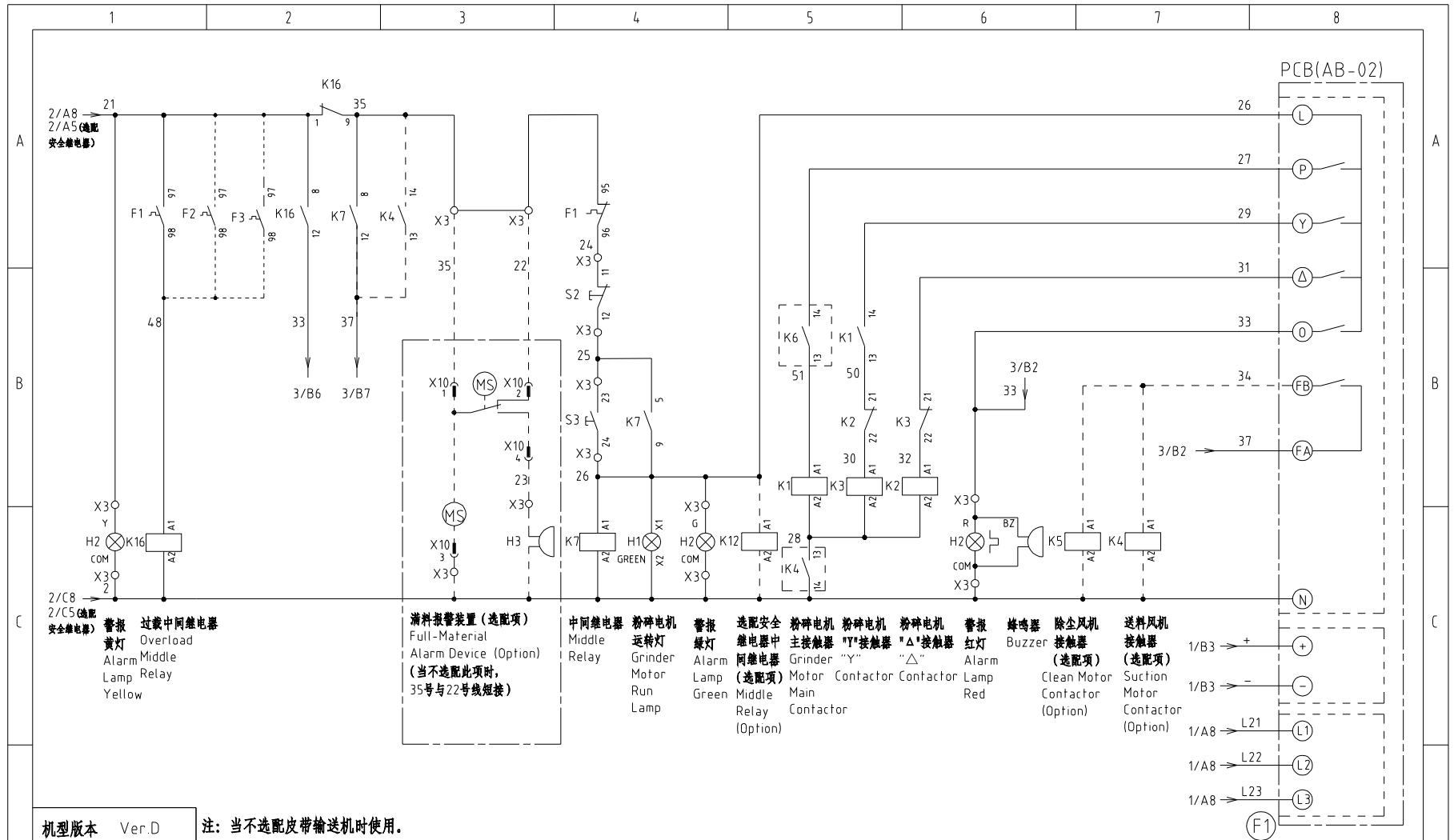

机型版本 Ver.D 注: 当不选配皮带输送机时使用。

制图		版号		标题		图号		比例		第 3 张	
设计		核准		SG-4390B(H)		SG-4390B(H)-GB-400V-F-3		标准		GB	
校对		日期		控制电路图二				机器电压		3φ400V	
审核		日期		SHINI 信易電熱機械股份有限公司		Shini Plastics Technologies, Inc.		机器频率		50Hz	
标记		更改人		日期		20220805					
1	2	3	4	5	6	7	8				

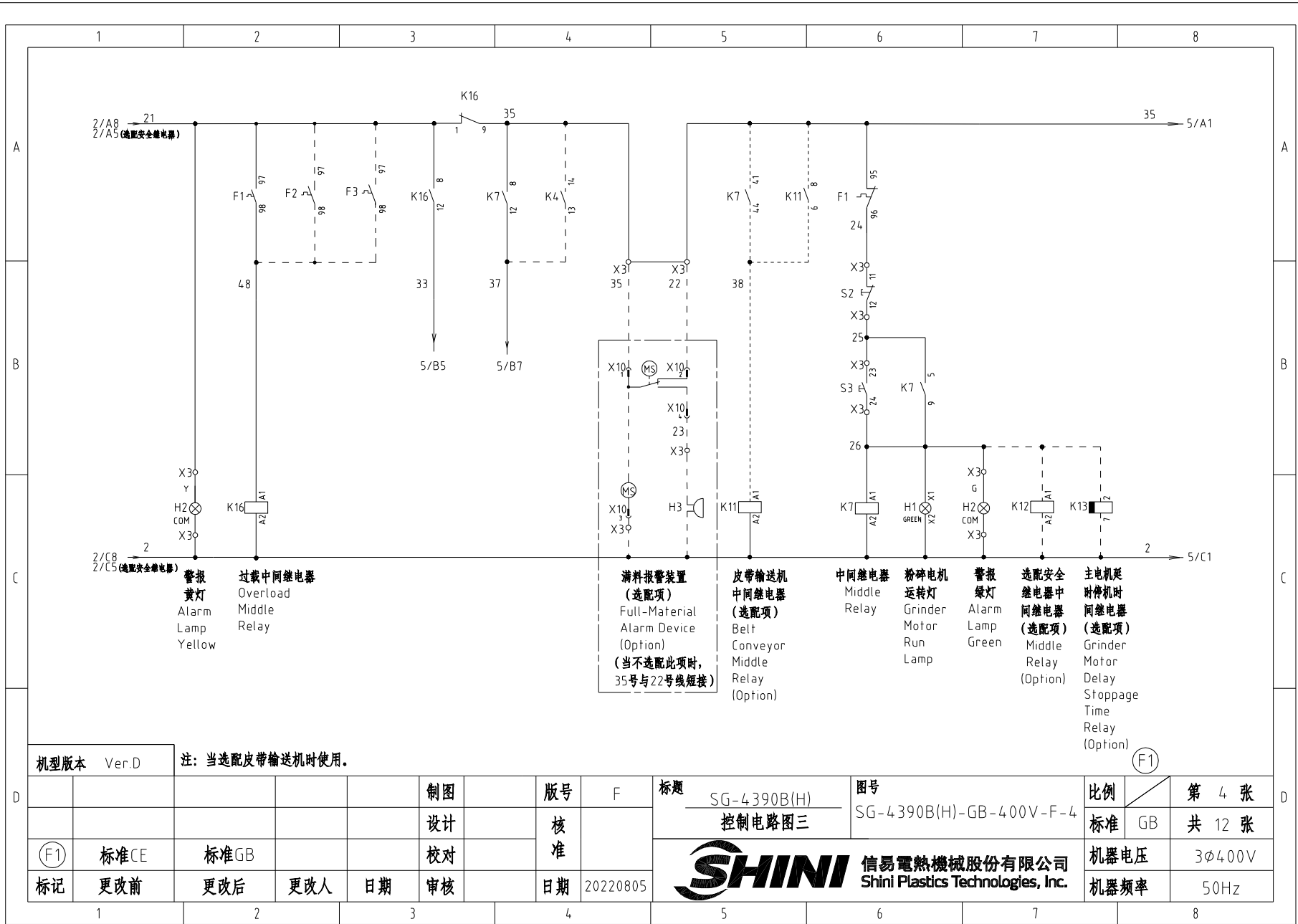

注：当选配皮带输送机时使用。

机型版本 Ver.D				制图		版号 F		标题 SG-4390B(H) 控制电路图三		图号 SG-4390B(H)-GB-400V-F-4		比例 第 4 张	
				设计		核准				标准 GB		共 12 张	
(F1)	标准CE	标准GB		校对				信易電熱機械股份有限公司 Shini Plastics Technologies, Inc.		机器电压		3φ400V	
标记	更改前	更改后	更改人	日期	审核	日期	20220805			机器频率		50Hz	

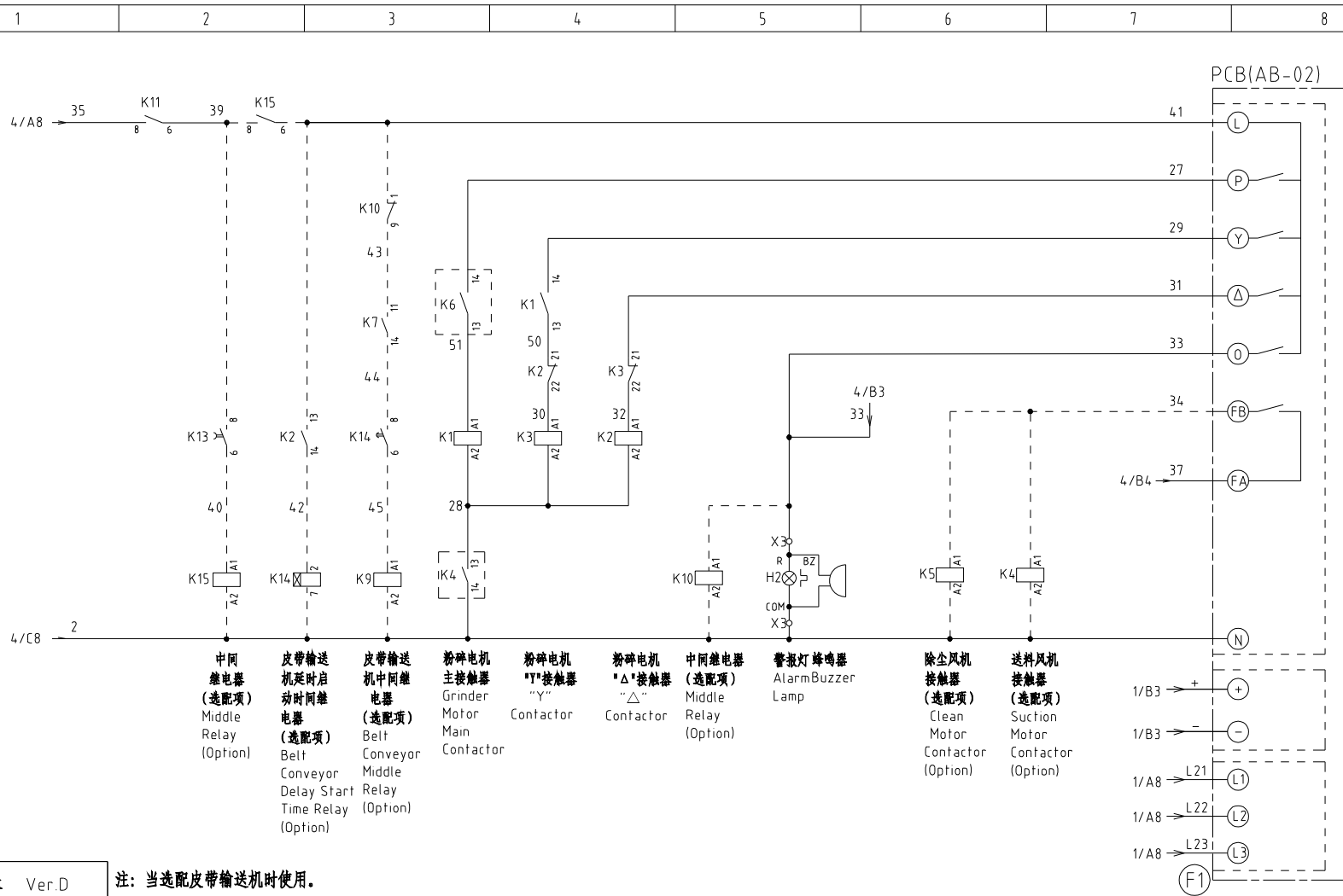

- 中间继电器 (选项) Middle Relay (Option)
- 皮带输送机延时启动时间继电器 (选项) Belt Conveyor Delay Start Time Relay (Option)
- 皮带输送机中间继电器 (选项) Belt Conveyor Middle Relay (Option)
- 粉碎机主接触器 Grinder Motor Main Contactor
- 粉碎机“Y”接触器 Contactor
- 粉碎机“Δ”接触器 Contactor
- 中间继电器 (选项) Middle Relay (Option)
- 警报灯蜂鸣器 Alarm Buzzer Lamp
- 除尘风机接触器 (选项) Clean Motor Contactor (Option)
- 送料风机接触器 (选项) Suction Motor Contactor (Option)

机型版本 Ver.D 注: 当选配皮带输送机时使用。

	制图	版号	F	标题	图号	比例	第 5 张
	设计	核准		SG-4390B(H) 控制电路图三	SG-4390B(H)-GB-400V-F-5	标准 GB	共 12 张
(F1)	标准CE	标准GB	校对	信易電熱機械股份有限公司 Shini Plastics Technologies, Inc.	机器电压	3φ400V	
标记	更改前	更改后	更改人		日期	机器频率	50Hz
1	2	3	4	5	6	7	8

选配皮带输送机控制触点接线示意图

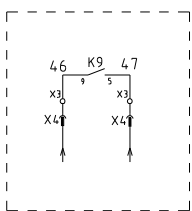

×4 金属接头接线示意图
接皮带输送机
(选选项)

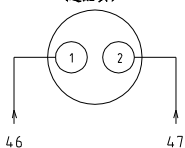

×10 金属接头接线示意图
接满料报警装置
(选选项)

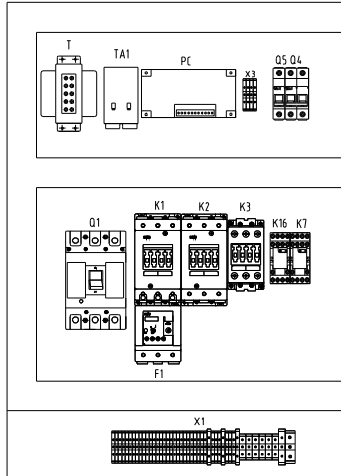
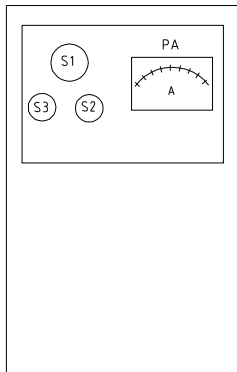
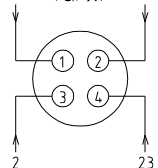

标准机型布局图

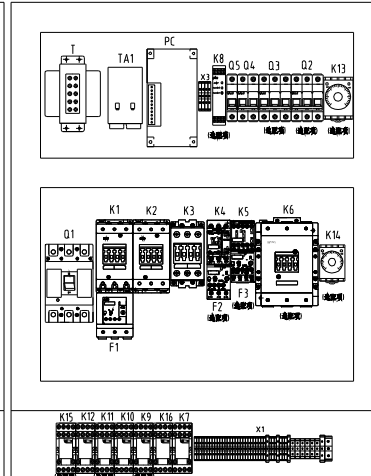

选配机型布局图

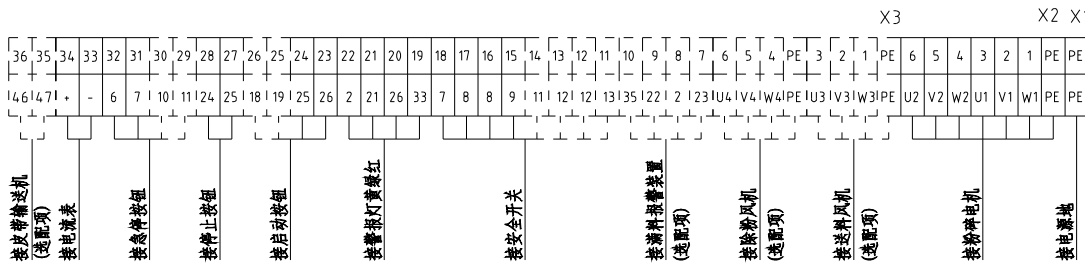

X11: 16P 重载接插件

①	7	⑨	
②	9	⑩	
③	11	⑪	
④	13	⑫	
⑤		⑬	
⑥		⑭	
⑦		⑮	
⑧		⑯	

注: 当不选配安全继电器时将9号端子改为21号, 11号端子和13号端子不用接

机型版本 Ver.D 注: 当不选配安全继电器时将6号端子改为3号, 9号端子改为21号。

(F1)

制图		版号		标题		图号		比例		第 6 张	
设计		核准		SG-4390B(H)		SG-4390B(H)-GB-400V-F-6		标准		共 12 张	
校对		日期		SHINI		信易电热机械股份有限公司		机器电压		3φ400V	
审核		日期		Shini Plastics Technologies, Inc.				机器频率		50Hz	
标记	更改前	更改后	更改人	日期	20220805						

1

2

3

4

5

6

7

8

1	2	3	4	5	6	7	8				
序号/NO	符号/Symbol	名称/Name	制造商/Manufacturer	型号/Type	规格/Specification	数量/Number	物料编号/Material number	备注/Remark			
1	Q1	门连锁断路器/Gate circuit breaker	TECO	TAX-125L3125 3P	125A	1	YE40125301100				
2		断路器外部操作把手/External operating handle	TECO	FB1R-CS1-C-D1x(TAX-125)	----	1	YE90111100300				
3	Q2	断路器/Circuit-breaker	TECO	BM-63C/3P	10A	1	YE40301003000	(6)			
4	Q2	断路器/Circuit-breaker	TECO	BM-63C/3P	32A	1	YE40303203000	(7)			
5	Q3	断路器/Circuit-breaker	TECO	BM-63C/3P	6A	1	YE40300603000	(2)			
6	Q4	断路器/Circuit-breaker	TECO	BM-63C/2003S 2P	3A	1	YE40200203000				
7	Q5	断路器/Circuit-breaker	TECO	BM-63C/1010S 1P	10A	1	YE40101000100				
8	K1,K2	接触器/Contactor	SIEMENS	3RT5036-1AC20	50A 24VAC 50/60Hz	2	YE00503602600				
9		辅助触点/Auxiliary Contactor	SIEMENS	3RH5921-1CA10	1NO	1	YE00592110000				
10	K3	接触器/Contactor	SIEMENS	3RT5035-1AC20	40A 24VAC 50/60Hz	1	YE00503502600				
11	K3	接触器/Contactor	SIEMENS	3RT5036-1AC20	50A 24VAC 50/60Hz	1	YE00503602600	(8)			
12		辅助触点/Auxiliary Contactor	SIEMENS	3RH5921-1CA01	1NC	2	YE00592110100				
13		辅助触点/Auxiliary Contactor	SIEMENS	3RH5921-1CA10	1NO	1	YE00592110000	(5)			
14		辅助触点/Auxiliary Contactor	SIEMENS	3RH5921-1CA01	1NC	1	YE00592110100	(4)			
15	K4	接触器/Contactor	SIEMENS	3RT6016-1AB01	9A 24VAC 50/60Hz	1	YE00601602500	(6)			
16	K4	接触器/Contactor	SIEMENS	3RT6026-1AC20	25A 24VAC 50/60Hz	1	YE00602602600	(7)			
17		辅助触点/Auxiliary Contactor	SIEMENS	3RH6911-1HA11	1NC+1NO	1	YE00691100100	(6)			
18	K5	接触器/Contactor	SIEMENS	3RT6016-1AB02	9A 24VAC 50/60Hz	1	YE00601602600	(2)			
19	K6	接触器/Contactor	SIEMENS	3RT5046-1AC20	95A 24VAC 50/60Hz	1	YE00504602600	(4)			
20		辅助触点/Auxiliary Contactor	SIEMENS	3RH5921-1CA01	1NC	1	YE00592110100	(4)			
21		辅助触点/Subsidiary Contactor	SIEMENS	3RH5921-1CA10	1NO	1	YE00592110000	(4)			
22	K7	中间继电器/Middle relay	Honeywell	GR-2C-AC24V	24VAC	1	YE03022400300				
23	K7	中间继电器/Middle relay	Honeywell	GR-4C-AC24V	24VAC	1	YE03042400300	(5)			
24	K8	安全继电器/Safety relay	PILZ	PN0Z×2.8P	24V AC/DC	1	YE04023000000	(4)			
25	K9 K10 K11 K15	中间继电器/Middle relay	Honeywell	GR-2C-AC24V	24VAC	4	YE03022400300	(5)			
机型版本 Ver.D		注: (1)表示非电控箱内材料; (2)表示除尘风机选配配件; (3)表示满料报警装置选配配件; (4)表示安全继电器选配配件; (5)表示皮带输送机选配配件; (6)表示送料风机选配配件; (7)表示大功率送料风机选配配件。 (F1)									
		制图		版号 F		标题 SG-4390B		图号 SG-4390B(H)-GB-400V-F-7		比例 第 7 张	
		设计		核准		电气元件明细一		标准 GB		共 12 张	
(F1) 标准CE		标准GB		校对		 信易電熱機械股份有限公司 Shini Plastics Technologies, Inc.		机器电压		3φ400V	
标记 更改前		更改后		更改人				日期 20220805		机器频率	
1	2	3	4	5	6	7	8				

1	2	3	4	5	6	7	8			
序号/NO	符号/Symbol	名称/Name	制造商/Manufacturer	型号/Type	规格/Specification	数量/Number	物料编号/Material number	备注/Remark		
26	K12	中间继电器/Middle relay	Honeywell	GR-2C-AC24V	24VAC	1	YE03022400300	(4)		
27	K13	定时器/Timer	YUYUN	TRF-N/3M	24VAC	1	YE86032400000	(5)		
28	K14	定时器/Timer	YUYUN	TH3A-NAB 60S	24VAC	1	YE86602400300	(5)		
29	F2	热过载继电器/Overload relay	SIEMENS	3RU6116-1FB0	3.5-5A	1	YE01160350000	(6)		
30	F2	热过载继电器/Overload relay	SIEMENS	3RU6126-4BB0	14-20A	1	YE01260140000	(7)		
31	F1	热过载继电器/Overload relay	SIEMENS	3RU5136-4GB0	36-45A	1	YE01612660000			
32	F3	热过载继电器/Overload relay	SIEMENS	3RU6116-1BB0	14-2A	1	YE0160140000	(2)		
33	K16	中间继电器/Middle relay	Honeywell	GR-2C-AC24V	24VAC	1	YE03022400300			
34	S1	急停按钮/Emergency stop button	SCHNEIDER	XB2BS542C	400VAC	1	YE11254200000	(1)		
35		触点块/Contact block	SCHNEIDER	ZB2BE102C	1NC	1	YE00210203100	(1)(4)		
36	S2	停止按钮/Stop button	SCHNEIDER	XB2BA22C	400VAC	1	YE11222000000	(1)		
37	S3,H1	启动按钮(带灯)/Start button	SCHNEIDER	XB2BW33B1C	24VAC	1	YE11233100000	(1)		
38		触点块/Contact block	SCHNEIDER	ZB2BE101C	1NO	1	YE00210103100	(1)(4)		
39	S4,S5	安全开关/Safety switch	SCHMERSRC	AZ16-02ZVRK-1476	230VAC	2	YE16147600000	(1)(4)		
40	S4,S5	安全开关/Safety switch	SCHMERSRC	AZ15-02ZVRK-1476	230VAC	2	YE16147600100	(1)		
41	H2	三色警报灯/Alarm lamp	SHINI	红绿黄优先顺序+蜂鸣器	24VAC/DC 50/60Hz	1	BL90002401520	(1)		
42	H3	蜂鸣器/Buzzer	TEND	EA-2	24VAC	1	YE84240200000	(1)(3)		
43	MS	料位马达/Feed position motor	SHINI	SR-80	24VAC	1	YE15802400100	(1)(3)		
44	T	互感变压器/Transformer	----	IN=400V/415V OUT=24V	180VA	1	YE70040006700			
45	T	互感变压器/Transformer	----	IN=400V/415V OUT=24V	350VA	1	YE70040009900	(4)		
46	TA1	电流互感器/Current mutual inductance	RATIO	RQT-35	100/5A	1	YE04100500000			
47	PA	电流表/Galvanometry	SFIM	DH-670	100/5A	1	YE25671000000	(1)		
48	PCB	微电脑板/PCB	YUYUN	AB-02	24VAC	1	YE80022400100			
49		塑膠外壳SI-4T線路板用	----	----	----	1	YR40000400100			
50	TA2	电流互感器/Current mutual inductance	YUYUN	----	5-100A	1	----	线路板自带		
机型版本 Ver.D		注: (1)表示非电控箱内材料; (2)表示除尘风机及配件; (3)表示满料报警装置及配件; (4)表示安全继电器及配件; (5)表示皮带输送机及配件; (6)表示送料风机及配件; (7)表示大功率送料风机及配件。 (F1)								
		制图		版本号	F	标题 SG-4390B		图号	比例	第 8 张
		设计		核准		电气元件明细二		SG-4390B(H)-GB-400V-F-8	标准 GB	共 12 张
(F1)		标准CE	标准GB	校对		 信易電熱機械股份有限公司 Shini Plastics Technologies, Inc.			机器电压	3φ400V
标记		更改前	更改后	更改人	日期				20220805	机器频率
1	2	3	4	5	6	7	8			

1	2	3	4	5	6	7	8					
序号/NO	符号/Symbol	名称/Name	制造商/Manufacturer	型号/Type	规格/Specification	数量/Number	物料编号/Material number	备注/Remark				
51	X1	端子排/Terminal	Honeywell	GK16PE	16mm ² PE	1	YE60001603500					
52	X2	端子排/Terminal	Honeywell	GK10	10mm ²	6	YE60001003200					
53		端子排/Terminal	Honeywell	GK10PE	10mm ² PE	1	YE60001003500					
54	X3	端子排/Terminal	Honeywell	SK2.5	2.5mm ²	16	YE60002503200					
55			Honeywell	SK2.5	2.5mm ²	5	YE60002503200	(6)				
56			Honeywell	GK2.5PE	2.5mm ² PE	1	YE60002503400	(6)/(7)				
57			Honeywell	SK2.5	2.5mm ²	5	YE60002503200	(2)				
58			Honeywell	GK2.5PE	2.5mm ² PE	1	YE60002503400	(2)				
59			Honeywell	SK2.5	2.5mm ²	4	YE60002503200	(3)				
60			Honeywell	SK2.5	2.5mm ²	2	YE60002503200	(5)				
61			Honeywell	SK2.5	2.5mm ²	8	YE60002503200	(4)				
62			Honeywell	SK6	6mm ²	3	YE60000603200	(7)				
63			Honeywell	SK6PE	6mm ² PE	1	YE60000603500	(7)				
64		终端固定件B/GX系列	Honeywell	----	PCS	4	YE60000003900					
65	X4	金属接头/Metal tie in	SHINI	PLT-162-RR(公)	2P	1	YE68016200100	(1)(5)				
66	X10	金属接头/Metal tie in	SHINI	PLT-254-PM	4P	1	YE68025400000	(1)(3)				
67		金属接头/Metal tie in	----	PLT-254-RF	4P	1	YE68025400100	(1)(3)				
68	X11	重载接插件/Heavy duty connector	HARTING	16P+PE(公插+母座)	16P	1	YE68001601300	(1)				
69	M1	粉碎电机/Granulating motor	----	----	400V 50Hz 37kW	1	----	(1)				
70	M2	送料风车/Solution blower	----	----	400V 50Hz 3kW	1	----	(1)(6)				
71	M2	送料风车/Solution blower	----	----	400V 50Hz 7.5kW	1	----	(1)(7)				
72	M3	除尘风车/Dust blower	----	----	400V 50Hz 0.75kW	1	----	(1)(2)				
机型版本 Ver.D 注: (1)表示非电控箱内材料; (2)表示除尘风机选配件; (3)表示满料报警装置选配件; (4)表示安全继电器选配件; (5)表示皮带输送机选配件; (6)表示送料风机选配件; (7)表示大功率送料风机选配件。 (F1)												
制图			版号		标题		图号		比例		第 9 张	
设计			核 准		SG-4390B 电气元件明细三		SG-4390B(H)-GB-400V-F-9		标准		GB 共 12 张	
(F1) 标准CE			标准GB		 信易電熱機械股份有限公司 Shini Plastics Technologies, Inc.		机器电压		3φ400V			
标记 更改前			更改后				机器频率		50Hz			
1	2	3	4	5	6	7	8					

1	2	3	4	5	6	7	8		
序号/NO	符号/Symbol	名称/Name	制造商/Manufacturer	型号/Type	规格/Specification	数量/Number	物料编号/Material number	备注/Remark	
1	Q1	门连锁断路器/Gate circuit breaker	TECO	TAX-125L3125 3P	125A	1	YE40125301100		
2		断路器外部操作把手/External operating handle	TECO	FB1R-CS1-C-D1x(TAX-125)	----	1	YE90111100300		
3	Q2	断路器/Circuit-breaker	TECO	BM-63C/3P	10A	1	YE40301003000	(6)	
4	Q2	断路器/Circuit-breaker	TECO	BM-63C/3P	32A	1	YE40303203000	(7)	
5	Q3	断路器/Circuit-breaker	TECO	BM-63C/3P	6A	1	YE40300603000	(2)	
6	Q4	断路器/Circuit-breaker	TECO	BM-63C/2003S 2P	3A	1	YE40200203000		
7	Q5	断路器/Circuit-breaker	TECO	BM-63C/1010S 1P	10A	1	YE40101000100		
8	K1,K2	接触器/Contactor	SIEMENS	3RT5044-1AC20	65A 24 VAC 50/60Hz	2	YE00504402600		
9		辅助触点/Auxiliary Contactor	SIEMENS	3RH5921-1CA10	1NO	1	YE00592110000		
10	K3	接触器/Contactor	SIEMENS	3RT5036-1AC20	50A 24 VAC 50/60Hz	1	YE00503602600		
11		辅助触点/Auxiliary Contactor	SIEMENS	3RH5921-1CA01	1NC	2	YE00592110100		
12		辅助触点/Auxiliary Contactor	SIEMENS	3RH5921-1CA10	1NO	1	YE00592110000	(5)	
13		辅助触点/Auxiliary Contactor	SIEMENS	3RH5921-1CA01	1NC	1	YE00592110100	(4)	
14	K4	接触器/Contactor	SIEMENS	3RT6016-1AB01	9A 24 VAC 50/60Hz	1	YE00601602500	(6)	
15	K4	接触器/Contactor	SIEMENS	3RT6026-1AC20	25A 24 VAC 50/60Hz	1	YE00602602600	(7)	
16		辅助触点/Auxiliary Contactor	SIEMENS	3RH6911-1HA11	1NC+1NO	1	YE00691100100	(6)	
17	K5	接触器/Contactor	SIEMENS	3RT6016-1AB02	9A 24 VAC 50/60Hz	1	YE00601602600	(2)	
18	K6	接触器/Contactor	SIEMENS	3RT5054-1AB36	115A 24V 50/60Hz	1	YE00505400900	(4)	
19		辅助触点/Subsidiary Contactor	SIEMENS	3RH5921-1CA10	1NO	1	YE00592110000	(4)	
20	K7	中间继电器/Middle relay	Honeywell	GR-2C-AC24V	24 VAC	1	YE03022400300		
21	K7	中间继电器/Middle relay	Honeywell	GR-4C-AC24V	24 VAC	1	YE03042400300	(5)	
22	K8	安全继电器/Safety relay	PILZ	PN0Z×2.8P	24V AC/DC	1	YE04023000000	(4)	
23	K9 K10 K11 K15	中间继电器/Middle relay	Honeywell	GR-2C-AC24V	24 VAC	4	YE03022400300	(5)	
24	K12	中间继电器/Middle relay	Honeywell	GR-2C-AC24V	24 VAC	1	YE03022400300	(4)	
25	K13	定时器/Timer	YUYUN	TRF-N/3M	24 VAC	1	YE86032400000	(5)	
机型版本 Ver.D		注: (1)表示非电控箱内材料; (2)表示除尘风机选配件; (3)表示满料报警装置选配件; (4)表示安全继电器选配件; (5)表示皮带输送机选配件; (6)表示送料风机选配件; (7)表示大功率送料风机选配件。 (F1)							
D			制图	版号	F	标题	图号	比例	第 10 张
			设计	核准		SG-4390BH	SG-4390B(H)-GB-400V-F-10	标准 GB	共 12 张
	(F1)	标准CE	标准GB	校对		 信易電熱機械股份有限公司 Shini Plastics Technologies, Inc.	机器电压	3φ400V	
	标记	更改前	更改后	更改人	日期		20220805	机器频率	50Hz
1	2	3	4	5	6	7	8		

1	2	3	4	5	6	7	8						
序号/NO	符号/Symbol	名称/Name	制造商/Manufacturer	型号/Type	规格/Specification	数量/Number	物料编号/Material number	备注/Remark					
26	K14	定时器/Timer	YUYUN	TH3A-NAB 60S	24VAC	1	YE86602400300	(5)					
27	F1	热过载继电器/Overload relay	SIEMENS	3RU5146-4 JB0	4.5-6.3A	1	YE01514640000						
28	F2	热过载继电器/Overload relay	SIEMENS	3RU6126-4BB0	14-20A	1	YE01260140000	(7)					
29	F2	热过载继电器/Overload relay	SIEMENS	3RU6116-1FB0	3.5-5A	1	YE01160350000	(6)					
30	F3	热过载继电器/Overload relay	SIEMENS	3RU6116-1BB0	1.4-2A	1	YE01160140000	(2)					
31	K16	中间继电器/Middle relay	Honeywell	GR-2C-AC24V	24VAC	1	YE03022400300						
32	S1	急停按钮/Emergency stop button	SCHNEIDER	XB2BS542C	400VAC	1	YE11254200000	(1)					
33		触点块/Contact block	SCHNEIDER	ZB2BE102C	1NC	1	YE00210203100	(1)(4)					
34	S2	停止按钮/Stop button	SCHNEIDER	XB2BA22C	400VAC	1	YE11222000000	(1)					
35	S3,H1	启动按钮(带灯)/Start button	SCHNEIDER	XB2BW33B1C	24VAC	1	YE11233100000	(1)					
36		触点块/Contact block	SCHNEIDER	ZB2BE101C	1NO	1	YE00210103100	(1)(4)					
37	S4,S5	安全开关/Safety switch	SCHMERSRC	AZ15-02ZVRK-1476	230VAC	2	YE16147600100	(1)					
38	S4,S5	安全开关/Safety switch	SCHMERSRC	AZ16-02ZVRK-1476	230VAC	2	YE16147600000	(1)(4)					
39	H2	三色警报灯/Alarm lamp	SHINI	红绿黄优先顺序+蜂鸣器	24VAC/DC 50/60Hz	1	BL90002401520	(1)					
40	H3	蜂鸣器/Buzzer	TEND	EA-2	24VAC	1	YE84240200000	(1)(3)					
41	MS	料位马达/Feed position motor	SHINI	SR-80	24VAC	1	YE15802400100	(1)(3)					
42	T	互感变压器/Transformer	----	IN=400V/415V OUT=24V	230VA	1	YE70040009800						
43	T	互感变压器/Transformer	----	IN=400V/415V OUT=24V	350VA	1	YE70040009900	(4)					
44	TA1	电流互感器/Current mutual inductance	RATIO	RCT-35	150/5A	1	YE04150500000						
45	PA	电流表/Galvanometry	SFIM	DH-670	150/5A	1	YE25671500000	(1)					
46	PCB	微电脑板/PCB	YUYUN	AB-02	24VAC	1	YE80022400100						
47		塑膠外壳SI-4T線路板用	----	----	----	1	YR40000400100						
48	TA2	电流互感器/Current mutual inductance	YUYUN	----	5-100A	1	----	线路板自带					
49	X1	端子排/Terminal	Honeywell	GK16PE	16mm ² PE	1	YE60001603500						
50	X2	端子排/Terminal	Honeywell	GK16	16mm ²	6	YE60001603200						
机型版本 Ver.D		注: (1)表示非电控箱内材料; (2)表示除尘风机选配件; (3)表示满料报警装置选配件; (4)表示安全继电器选配件; (5)表示皮带输送机选配件; (6)表示送料风机选配件; (7)表示大功率送料风机选配件。 (F1)											
D				制图		版号	F	标题	SG-4390BH	图号		比例	第 11 张
				设计		核准		电气元件明细二	SG-4390B(H)-GB-400V-F-11		标准	GB	共 12 张
	(F1)	标准CE	标准GB	校对		核准		 信易電熱機械股份有限公司 Shini Plastics Technologies, Inc.		机器电压	3φ400V		
	标记	更改前	更改后	更改人	日期	审核	日期		20220805	机器频率	50Hz		
1	2	3	4	5	6	7	8						

1	2	3	4	5	6	7	8	
序号/NO	符号/Symbol	名称/Name	制造商/Manufacturer	型号/Type	规格/Specification	数量/Number	物料编号/Material number	备注/Remark
51		端子排/Terminal	Honeywell	GK16PE	16mm ² PE	1	YE60001603500	
52	X3	端子排/Terminal	Honeywell	SK2.5	2.5mm ²	16	YE60002503200	
53			Honeywell	SK2.5	2.5mm ²	5	YE60002503200	(6)
54			Honeywell	GK2.5PE	2.5mm ² PE	1	YE600025034.00	(6)/(7)
55			Honeywell	SK2.5	2.5mm ²	5	YE60002503200	(2)
56			Honeywell	GK2.5PE	2.5mm ² PE	1	YE600025034.00	(2)
57			Honeywell	SK2.5	2.5mm ²	4	YE60002503200	(3)
58			Honeywell	SK2.5	2.5mm ²	2	YE60002503200	(5)
59			Honeywell	SK2.5	2.5mm ²	8	YE60002503200	(4)
60			Honeywell	SK6	6mm ²	3	YE60000603200	(7)
61			Honeywell	SK6PE	6mm ² PE	1	YE60000603500	(7)
62		终端固定件E/GX系列	Honeywell	----	PCS	4	YE60000003900	
63	X4	金属接头/Metal tie in	SHINI	PLT-162-RR(公)	2P	1	YE68016200100	(1)(5)
64	X10	金属接头/Metal tie in	SHINI	PLT-254-PM	4P	1	YE68025400000	(1)(3)
65		金属接头/Metal tie in	----	PLT-254-RF	4P	1	YE68025400100	(1)(3)
66	X11	重载接插件/Heavy duty connector	HARTING	16P+PE(公插-母座)	16P	1	YE68001601300	(1)
67	M1	粉碎电机/Granulating motor	----	----	400V 50Hz 4.5kW	1	----	(1)
68	M2	送料风车/Solution blower	----	----	400V 50Hz 3kW	1	----	(1)(6)
69	M2	送料风车/Solution blower	----	----	400V 50Hz 7.5kW	1	----	(1)(7)
70	M3	除尘风车/Dust blower	----	----	400V 50Hz 0.75kW	1	----	(1)(2)
机型版本 Ver.D 注: (1)表示非电控箱内材料; (2)表示除尘风机选配件; (3)表示满料报警装置选配件; (4)表示安全继电器选配件; (5)表示皮带输送机选配件; (6)表示送料风机选配件; (7)表示大功率送料风机选配件。 (F1)								
			制图	版号	标题	图号	比例	第 12 张
			设计	核 准	SG-4390BH	SG-4390B(H)-GB-400V-F-12	标准 GB	共 12 张
			校对	核 准	 信易電熱機械股份有限公司 Shini Plastics Technologies, Inc.	机器电压		3φ400V
			审核			日期	20220805	机器频率
1	2	3	4	5	6	7	8	