

SG-36 Series
Sound-proof Central Granulators

Date: Jan., 2023

Version: Ver.E (English)



Contents

1. General Description	7
1.1 Coding Principle.....	8
1.2 Feature	8
1.3 Safety Regulations.....	10
1.3.1 Safety signs and labels.....	10
1.3.2 Transportation and Storage of the Machine	12
1.4 Exemption Clause.....	14
2. Structural Features and Working Principle.....	15
2.1 General Description	15
2.1.1 Working Principle.....	15
2.2 Safety System.....	16
2.2.1 Emergency Stop.....	16
2.2.2 Safety Switch.....	16
2.2.3 Door Lock.....	17
2.3 Electrical Components Instruction.....	18
2.3.1 Microprocessor Board (PCB).....	18
2.4 Optional Accessories	19
2.4.1 DS-36 Dust separate System	19
2.4.2 Screen	19
2.4.3 Full-receiver Alarm Device	19
2.4.4 Feed Hopper with Magnet	20
2.4.5 Feeding Hopper for Conveyor	20
2.4.6 Material Side Feed Pipe	20
2.4.7 Other Options	20
3. Installation and Debugging	21
3.1 Installation Place.....	22
3.2 Power Connection.....	23
3.2.1 Check The Running Direction of The Motor	23
3.2.2 Check The Running Direction of The Blower.....	24
3.3 Options Installation	25

3.3.1	The Dust Separate System Installation	25
3.3.2	Conveying Belt Installation	25
4.	Operation Guide	26
4.1	Startup Pretest	26
4.1.1	Before the First Startup	26
4.1.2	After First Startup for 2 Hours	27
4.1.3	After First Startup for 20~30 Hours	27
4.2	Start / Stop of The Machine	27
4.3	Open the Feeding Hopper, Screen and the Storage box	28
4.3.1	Open The Feeding Hopper	28
4.3.2	Open The Storage Box and Screen	28
4.4	Close the Screen Bracket, Storage Box and Feeding Hopper	29
4.4.1	Installation of The Screen Bracket and The Storage Box	29
4.4.2	Close The Feed Box	30
5.	Trouble Shooting	31
5.1	Granulator Can Not Work	31
5.2	Stop Due to Other Reasons	31
6.	Maintenance and Repair	32
6.1	Repair	32
6.1.1	Dust Separate System Operation and Maintenance	32
6.1.2	Clean The Dust separate System	33
6.1.3	Replace the Blades	33
6.2	Installation of Bearing and Blade Rest	38
6.3	Installation of Belt Pulley and Motor	38
6.3.1	SG-3650	38
6.3.2	SG-3675	40
6.4	Installation of Storage Box, Screen and Screen Bracket	42
6.5	Installation of Feed Box and Feed Inlet	43
6.6	Transferring	44
6.6.1	Daily maintenance of V belts	44
6.6.2	Adjustments of V belts	45
6.7	Lubrication	46
6.7.1	Lubricating oils	46

6.7.2	Please grease the bearing with lubricating oils periodically.....	46
6.8	Cleaning.....	47
6.9	Maintenance Schedule	49
6.9.1	About the Machine.....	49
6.9.2	Check after Installation	49
6.9.3	Daily Check	49
6.9.4	Weekly Check	49
6.9.5	Monthly Check.....	50
6.9.6	Check Half-yearly or Every 1000 Running Hours	50
6.9.7	3 year Checking	50

Form index

Chart 6-1: Attached form, Cutters and Other Fixing Screw Torque	37
---	----

Picture index

Picture 2-1: Working Principle	15
Picture 2-2: Emergency Stop Button	16
Picture 2-3: Safety Switch	17
Picture 2-4: Door Lock.....	17
Picture 2-5: PCB.....	18
Picture 3-1: Installation Place 1	22
Picture 3-2: Installation Place 2	22
Picture 3-3: Installation Place 3	23
Picture 3-4: Blower	24
Picture 4-1: Position-adjusting Screws	27
Picture 4-2: Door Interlock Switch.....	27
Picture 4-3: Start, Stop and Emergency Stop Buttons	28
Picture 4-4: Close The Screen Bracket,Storage Box and Feeding Hopper.	29
Picture 6-1: Remove The Rotating Blades	34
Picture 6-2: Blades Installation Adjusting	35
Picture 6-3: Installation of Rotating and Fixed Blade	36

Picture 6-4: Installation of Bearing and Blade Rest	38
Picture 6-5: Installation of Belt Pulley and Motor 1 (SG-3650)	38
Picture 6-6: Installation of Belt Pulley and Motor 2(SG-3650)	39
Picture 6-7: Installation of Belt Pulley and Motor 2(SG-3650)	39
Picture 6-8: Installation of Belt Pulley and Motor 2 (SG-3650)	40
Picture 6-9: Installation of Belt Pulley and Motor 5 (SG-3650)	40
Picture 6-10: Installation of Belt Pulley and Motor 1 (SG-3675)	40
Picture 6-11: Installation of Belt Pulley and Motor 2 (SG-3675)	41
Picture 6-12: Installation of Belt Pulley and Motor 3 (SG-3675)	41
Picture 6-13: Installation of Belt Pulley and Motor 4 (SG-3675)	41
Picture 6-14: Installations of Storage box, Screen and Screen Bracket.	42
Picture 6-15: Installation of Feed Box and Feed Inletv 1	43
Picture 6-16: Installation of Feed Box and Feed Inletv 2	43
Picture 6-17: Installation of Feed Box and Feed Inletv 3	43
Picture 6-18: Installation of Feed Box and Feed Inletv 4	44
Picture 6-19: Installation of Feed Box and Feed Inletv 5	44
Picture 6-20: Daily Maintenance of V Belts	45
Picture 6-21: Adjustments of V Belts	46
Picture 6-22: Oil Throat	46

1. General Description



Please read this manual carefully before using this machine in order to operate correctly against any damage caused due to improper operation.



Note!

Always take great care when the knives are within reach, they are very sharp and can cause personal injury.



Forbidden to process flammable or toxic material!

SG-36 series sound-proof central granulators are suitable for centralized recycling of wastes or rejected parts from injection moulding, blow moulding or extrusion lines. The machines feature optimized structure, easy operation, and quick blade replacement. Staggered rotating blades can easily grab and cut materials. This design makes the machine work more efficiently and can reduce waste of energy to the minimum. This granulator has various models with wide application to meet different customers' demand.



Model: SG-3650

1.1 Coding Principle

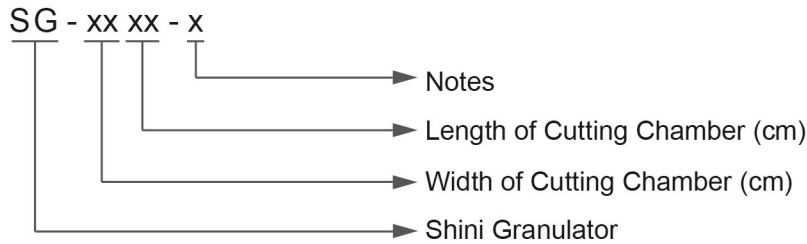

1.2 Feature

- Adopts paddle blades. It allows increased efficiency and reduced energy consumption.
- Blades adopt imported steel to ensure high quality and high durability.
- Full-closed design and sound-proofing ensure low noise level.
- Equipped with electrical current relay, motor overload protector and multiple safety devices.
- Cyclone dust separator can effectively remove the air from regrind and facilitates the material collecting.
- Dust collecting bag brings easiness for dust cleaning and reduce contamination.
- Regrind conveying system as standard.
- Adopts anti-vibration pads to absorb vibration during operation.
- For SG-36, cooling water device at the rear plate of the cutting chamber can effectively cool down the cutting chamber and prevent materials from melting-up.
- Equipped with presetting knife jig, rotating blades can be adjusted in the fixture outside the machine inside of machine instead of machine inside. It made blades adjustment much easier.
- Equipped with flywheel to improve cutting ability.

All service work should be carried out by a person with technical training or corresponding professional experience. The manual contains instructions for both handling and servicing. Chapter 7, which contains service instructions intended for service engineers. Other chapters contain instructions for the daily operator.

Any modifications of the machine must be approved by SHINI in order to avoid personal injury and damage to machine. We shall not be liable for any damage caused by unauthorized change of the machine.

Our company provides excellent after-sales service. Should you have any problem during using the machine, please contact the company or the local vendor.

Shini Hotline Service:

Headquarter and Taipei factory:

Tel: + 886 (0)2 2680 9119

Shini Plastics Technologies (Dongguan), Inc.:

Tel: +86 (0)769 8331 3588

Shini Plastics Technologies (Pinghu), Inc.:

Tel: +86 (0)573 8522 5288

Shinden Precision Machinery (Chongqing), Inc.:

+86 (0)23 6431 0898

1.3 Safety Regulations

Follow the instructions in this manual to avoid personal injury and damage to machine components.

The following safety measures shall be followed when operating the granulator.

1.3.1 Safety signs and labels



Electrical installation must only be done by a competent electrician!



Before the granulator is opened for servicing and maintenance, always disconnect the power with both the main switch and the control switch on the granulator.



Never put any part of your body through the granulator openings, unless both the main switch and the control switch on the granulator are in "Off" position.



High voltage! Danger!

This sign is attached on the control box and the wiring box.



Be careful with the rotating knives, they are very sharp and can cause personal injury!



If the rotor must be turned manually-do this with great care!



The granulator should not be able to start before the hopper and screen bracket are properly closed.



Attention please!

Ear protection is used during granulating of plastic materials.



Never remove protective sponge or quick coupling clips adjacent to the outlet of storage bin.



Make sure the power has been cut off before opening the feed box.



Loading blower applicable to convey regrind and powder and it requires that the temperature of regrind and powder should not be more than 80°C.



The loading blower has great suction power and it is easy to get goods or clothes sucked into, so it should have a protective cover.



Air inlet dust clean.



Concerning SG-36 the cutting chamber should be heat-processed and the blades must be changed before the granulators deal with fibre added material.



Attention!

No need for regular inspection because all the electrical parts in the control unit are fixed tightly!

When operate the granulator, please notice the following signs

	<p>Water outlet: drainage outlet.</p>
	<p>Water inlet: inlet for replenishing water and cooling water.</p>



Motor rotation directio.

1.3.2 Transportation and Storage of the Machine

Transportation

- 1) SG-36 series of granulators are packed in plywood cases with wooden pallet at the bottom, suitable for quick positioning by fork lift.
- 2) After unpacked, castors equipped on the machine can be used for ease of movement.
- 3) Do not rotate the machine and avoid collision with other objects during transportation to prevent improper functioning.
- 4) The structure of the machine is well-balanced, however, it also should be handled with care when lifting the machine to prevent falling down.
- 5) The machine and its attached parts can be kept with a temperature from -25°C to $+55^{\circ}\text{C}$ for long distance transporotation while for a short distance, it can be transported with temperature under $+70^{\circ}\text{C}$.

Storage

- 1) SG-36 series should be stored indoors with temperature kept from 5°C to 40°C and humidity below 80%.
- 2) Disconnect all power supply and turn off main switch and exigency stop switch
- 3) Keep the whole machine, especially the electrical components away from water to avoid potential troubles caused by the water.
- 4) Use plastic film to cover the machine tightly to prevent the machine from dust and rainwater.

Working environment

The machine should be operated:

- 1) Indoors with a dry environment of max. temperature $+45^{\circ}\text{C}$ and humidity no more than 80%.

Do not use the machine:



- 1) If it is with a damaged cord.
- 2) On a wet floor or when it is exposed to rain to avoid electric shock.
- 3) If it has been dropped or damaged until it is checked or fixed by a qualified serviceman.
- 4) This equipment works normally in the environment with altitude over 1,000m.
- 5) At least 1m surrounding space is requested when this equipment is running. Keep this equipment away from flammable sources at least two meters.
- 6) In the work area of vibration and strong magnetic force

Rejected parts disposal

When the equipment has run out its life time and can not be used any more, unplug the power supply and dispose of it properly according to local code.



Fire hazard!

In case of fire, CO₂ dry powder fire extinguisher should be applied.



Flammable materials or materials which are contaminated by flammable materials/liquid should not be processed in the granulator. Serious risk of fire or explosion may cause personnel injury.



It is very important to tighten the screw as required torque.



If process item is longer than feed port, please cut long items into half until the length is shorter than the feed port before processing.



Please don't put materials into the granulator if they are thinner than 2 mm and are soft and flexible, like rubber.

1.4 Exemption Clause

The following statements clarify the responsibilities and regulations born by any buyer or user who purchases products and accessories from Shini (including employees and agents).

Shini is exempted from liability for any costs, fees, claims and losses caused by reasons below:

1. Any careless or man-made installations, operation and maintenances upon machines without referring to the Manual prior to machine using.
2. Any incidents beyond human reasonable controls, which include man-made vicious or deliberate damages or abnormal power, and machine faults caused by irresistible natural disasters including fire, flood, storm and earthquake.
3. Any operational actions that are not authorized by Shini upon machine, including adding or replacing accessories, dismantling, delivering or repairing.
4. Employing consumables or oil media that are not appointed by Shini.

2. Structural Features and Working Principle

2.1 General Description

SG-36 series granulators applicable to granulate waste plastic for recycling use, mount magnet at the material inlet to clean out metal scraps and contaminations before granulating so to prevent metal scraps from getting into cutting chamber and bringing damage to the blades.

2.1.1 Working Principle

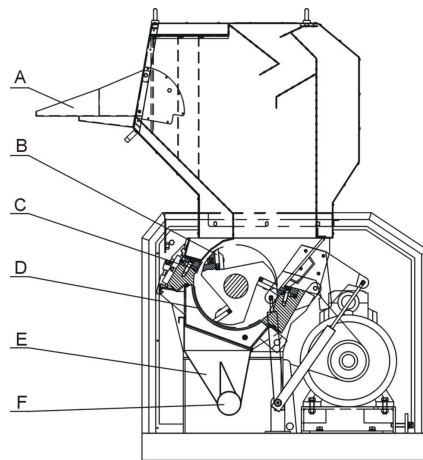

Parts name:

- | | | | |
|-------------------|---------------------|----------------|-----------|
| A. Material inlet | B. Rotating blade | C. Fixed blade | D. Screen |
| E. Storage bin | F. Discharging pipe | | |

Picture 2-1: Working Principle

The waste materials enter the cutting chamber via material inlet (A). The rotating blade (B) and fixed blade (C) grind the materials. The particle size is controlled by the size of screen (D). The screen (D) is located behind of the cutting chamber. Thus it is convenient to replace screen to other different sizes. The granulated materials are dropped into the storage box (E) via the screen and be conveyed via discharging pipe (F). The external material-conveying blower absorbs the granulated materials into the cyclone dust separator to separate the air and dust.

The obtained particles can be reused directly or sent to somewhere for storage. The foldable feed box has a good tunnel for maintenance, thus it is very convenient for cleaning.

2.2 Safety System

The granulator possesses a highly-secure safety system to avoid accident during the operation. The fast-rotating blade in the granulator is prone to result in an accident.

Thus, the safety system can protect human body. The safety system can be altered under no circumstances, otherwise the machine would in dangerous situation and can do harms. All repair and maintenance work should be carried out by the professionals.

If any safety system change takes place, no commitment will be fulfilled and all replaced components should be provided by SHINI.

2.2.1 Emergency Stop

Emergency stop is a red button on the control panel. Press it then the machine will stop working. It can be reset by turning the button as the arrow direction (anticlockwise).



Picture 2-2: Emergency Stop Button

2.2.2 Safety Switch

There are safe position switches for circuit breakers in the granulator. If there is any change, for example, the position of the door or the feed box changed or the circuit breaker is loose, the safety position switch will cut the power off and stop the machine.

Two safety switches may be involved. One is located between the feed box and the cutting chamber and the other links to the lock in the machine door.

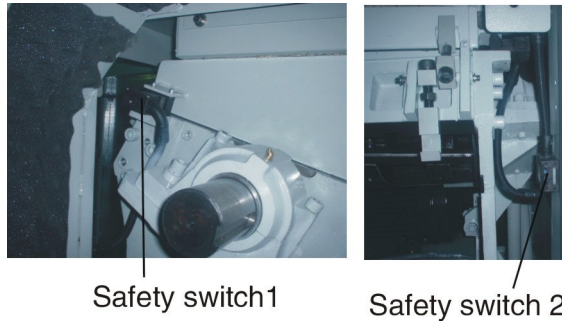

Picture 2-3: Safety Switch

2.2.3 Door Lock

The lock of the machine is a long hexagonal screw, which can extend the time of door opening to avoid any injury. When opening the door, this hexagonal screw shall be loosened. Loosening the door-lock needs a period of time avoiding personnel injury.

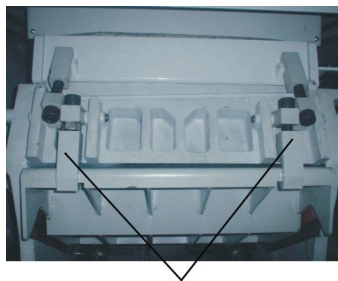

Hothook

Picture 2-4: Door Lock

Keep in mind before you start the granulator:

- 1) Whether the feed box has been tightly locked or not.
- 2) Whether the screen or the storage box has been well installed or not.
- 3) Close the machine door and screw the star screw tightly.

2.3 Electrical Components Instruction

2.3.1 Microprocessor Board (PCB)

- Function: 1) “Y” “ Δ ” reduced voltage starting.
 2) Granulating motor overload detection and alarm.
 3) Material conveying blower time-delay stop.
 4) phase sequence dection, warning and machine halt

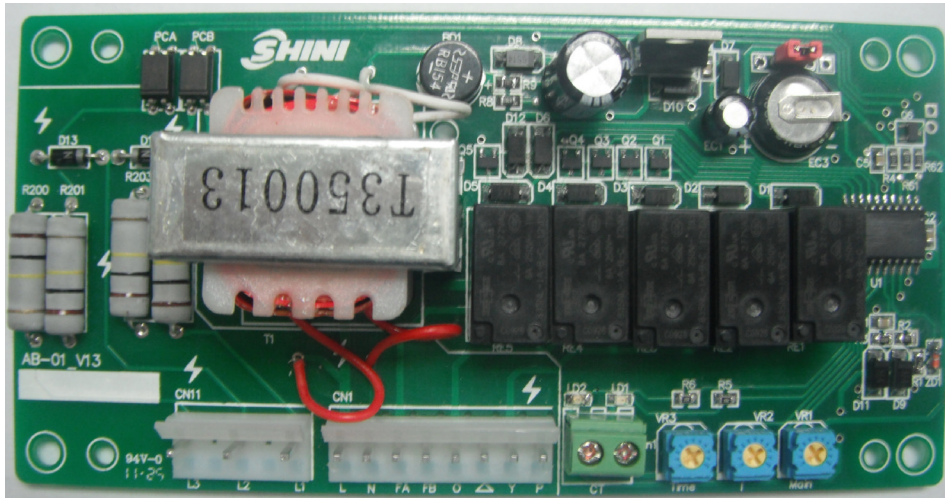

Picture 2-5: PCB

Scale of Variable Resistor	1	2	3	4	5	6	7	8	9
Fine Adjustment I(A): VR1	-4	-3	-2	-1	0	+1	+2	+3	+4
Rate Current setting (I): VR3	5A	10A	20A	30A	40A	50A	60A	70A	80A

Scale of Variable Resistor	1	2	3	4	5	6	7	8	9
Y Δ Start Switching : VR2	3S	6S	9S	12S	15S	19S	22S	24S	30S

2.4 Optional Accessories

2.4.1 DS-36 Dust separate System



Dust Separator can separate the dust in the regrind for immediate recycle use. The dust will be kept in filter bag, thus working environment will remain clean. This device ensures full use of regrind to avoid material wasting and enhance the economy returns.

2.4.2 Screen

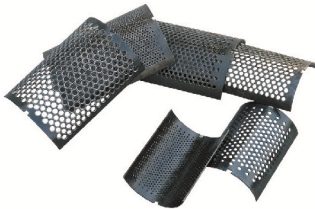

Special screen mesh sizes: $\Phi 8$, $\Phi 12$, $\Phi 14$, $\Phi 17$, $\Phi 25$ (mm) . Add "SS + screen diameter" at the end of the model code. E.g.: for 17mm screen, add "SS17" at the end of the model code.

2.4.3 Full-receiver Alarm Device

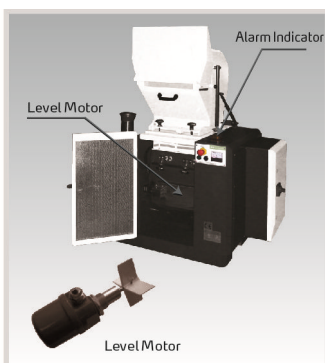

Full-receive alarm device helps to realize unmanned operation and no materials will be wasted. Whenever the regrind level reaches the motor position, the machine will be forced to stop and be cut off via its sensor, thus stop the granulator and warn the user by sounding an alarm. Add "FAD" at the end of the model code.

2.4.4 Feed Hopper with Magnet

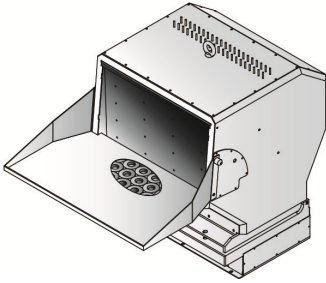

Feed hopper with magnet is used to take out metal craps and impurities in the material. Add "FHM" at the end of the model code.

2.4.5 Feeding Hopper for Conveyor



Material feeding for large granulators is quite a difficult matter. They are generally installed at a lower place or a platform must be built for material feeding. Shini particularly designed the belt conveyor to easily convey the material into the cutting chamber . Add "BCF" at the end of the model code.

2.4.6 Material Side Feed Pipe



The design of feeding hopper of traditional granulators is not suitable for long pipes and section bars. We have designed material side feed pipe for convenient feeding of long materials. Add "SF" at the end of the model code.

2.4.7 Other Options

- The function of fiber reinforced material granulating is optional. Adopt surface-hardening treatment on the material contacting component. And blade material is V-4E joint with S50°C. Add "F" at the end of the model code;
- Power increased blower enables material conveying in longer distance, at "EC" at the end of the model code.
- For stainless steel made feed hopper cover plate and storage tank, Add " R " at end of the model code.

3. Installation and Debugging



Read through this chapter before installation.



Install as following orders to avoid any accident!



Be careful! Not to be cut by the sharp blade.



Power connection must be done by the professional electrician to avoid electrical shock.



Caution!

cutters should be laid level, prevent the cutters from self-rotating when do installation, don't let your hands be near to the cutters to avoid personal injury.



Notice!

Do not install the cutters by working together, because this could bring personal injury. Use a thick wood block to stop the rotating knives from turning.



Notice!

The blades are very sharp, so use protective gloves to avoid being cut.



Notice!

Please use new screws and gaskets when installing cutters.



The power connection of the granulator should be carried out by professional electrician so to avoid electrical shock!

3.1 Installation Place



Make enough installation space to help the repair and maintenance.

Check and make sure the installation ground is level, there is enough intensity when it is running.

Use spirit level to adjust the cutting chamber to the level position.

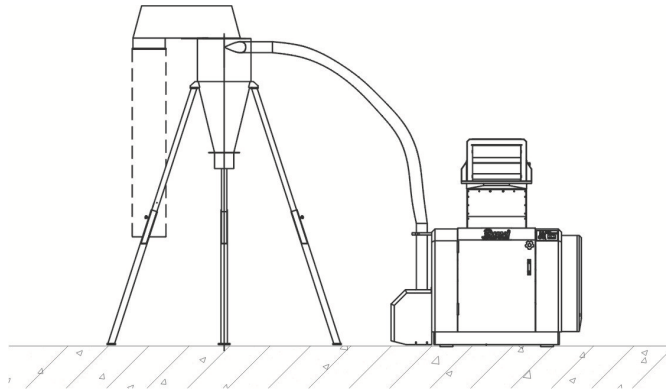

Picture 3-1: Installation Place 1

SG-36 rabbets for forklift to transport.

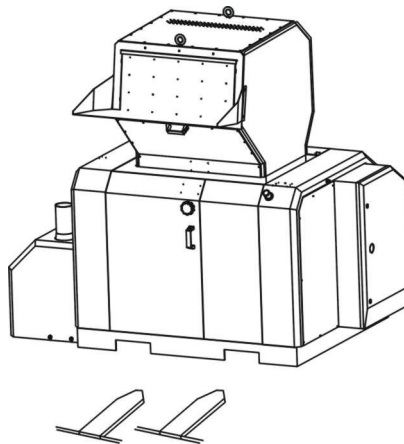

Picture 3-2: Installation Place 2

Note: Please do not install feed box on the mainbody of the granulator, then hoist them together, or it will cause damage to the machine.



Picture 3-3: Installation Place 3

3.2 Power Connection

- 1) Make sure voltage and frequency of the power source comply with those indicated on the manufacture's plate, which is attached to the machine.
- 2) Power cable and earth connections should conform with local regulations.
- 3) Use independent power cable and ON / OFF switch. The cable's dia. Should not smaller than those applied in the control box.
- 4) The power cable connection terminals should be tightened securely.
- 5) The machine requires a 3-phase 4-wire power source, connect the power lead (L1, L2, L3) to the live wires, and the earth (PE) to the ground.
- 6) Power supply requirements:
Main power voltage: +/- 5%
Main power frequency: +/- 2%
- 7) Power connection refers to the circuit diagram of each model.

3.2.1 Check The Running Direction of The Motor

- 1) Open the door to check whether the feed box is closed.
- 2) Close the door.
- 3) Ensure the main power switch is in ON position.
- 4) Check the emergency stop.
- 5) Startup.

- 6) The machine can not start there will be an alarm
 - a) Turn off the machine.
 - b) Turn off the interlock breaker.
 - c) Power line phase reverse, exchange each two of the three power lines.
 - d) Restart from step 5.

Note: The cutting tools may be damaged and the granulating capability will be reduced if there is a wrong running direction. Please disconnect the power and transpose any two wires of the three in the main power.

3.2.2 Check The Running Direction of The Blower

- 1) Check whether the running direction of the blower is in accordance with the symbol on the shield.
- 2) Connect to the power and stop again to check the blower's running direction.

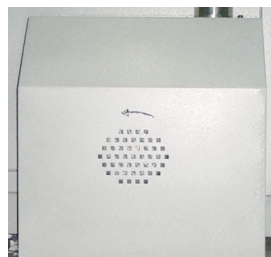

Picture 3-4: Blower

Note: If the blower's running direction is not in accordance with the symbol, the machine's working capability will be reduced by at least 25 percent. Under these circumstances, please disconnect to the main power and transpose any two wires of the three in the blower.

3.3 Options Installation

3.3.1 The Dust Separate System Installation



Read chapter 3 carefully before operating on dust separate system the circuit connection of the system should be done by professional electrician.

Before first startup

The unpainted parts of the machine are protected with oil prior to delivery and transport. Clean the granulator from rust protection agent before it is used.

Connection

- 1) Place a separator under cyclone device, the diameter is Φ 250mm.
- 2) Connect to conveying pipe, the diameter is 4 inches \times 2.
- 3) Mount dust collection device including air and dust separate bags.
- 4) Place a container under the separator to help collecting plastic material after dust removing

Notes: If use cloth bag to connect the separator, please make sure a good ventilation within the cloth bag.

3.3.2 Conveying Belt Installation

- 1) Connect belt main frame to floor stand with hexagon bolt.
- 2) Put belt top end to feed box inlet.
- 3) Insert belt power plug into power socket.
- 4) Connect metal head of belt control wire to control box socket.

4. Operation Guide



Wear earplugs during operating to avoid personal injury!



Wear gloves during operating to avoid personal injury!



Wear goggles during operating to avoid personal injury!



Because the blades and rotor may be loosen, check the following items before operating:

- 1) 1) If the blades has any damage;
- 2) 2) If the surface of the rotor is loosen;
- 3) 3) Push or pull the rotor and blades to see if there is any loose connection.

If any of the above situations is found, please contact local representative or SHINI Company for help.

4.1 Startup Pretest

Unpainted part of the machine has been covered with stainless oil. Before use, the stainless oil should be cleaned.

- 1) Clean with a towel
- 2) Wash with a towel dipping with amyl acetate.

4.1.1 Before the First Startup

- 1) Check whether the granulator is in the level state.

Note: Adjust the machine to make its four holders to share the weight and be in a level state.

- 2) Check the space of the cutting tools (0.2~0.3mm) to see whether the lockup screws of the blades are tightened (fixed blade M16x50, rotating M16x55).

4.1.2 After First Startup for 2 Hours

- 1) Check the space of the cutting tools of the fixed blades and rotating blades again; check whether the lockup screws of the blades are loose.
- 2) Check the position-adjusting screws of the motor and check whether the position-adjusting screws are tightened.



Picture 4-1: Position-adjusting Screws

4.1.3 After First Startup for 20~30 Hours

Check and adjust the belt's tensility after a 20~30-hour full-load operation.

4.2 Start / Stop of The Machine

SG-36 series of granulators via the main power switch, safety switch, “start/stop” button and the “emergency stop button” to control the machine.

Main power switch:

The main power switch of granulator is mounted on control box. The connection of the power is controlled by rotating of the main power switch.

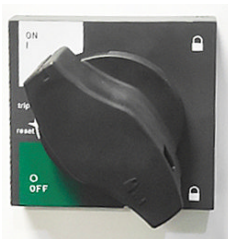

Picture 4-2: Door Interlock Switch

Start/Stop Button:

The granulator has start/stop button, which controls machine's start/stop.

Emergency Stop Button:

Besides, the machine has design of emergency stop button. When accident or emergency happens, press down the emergency stop button to stop the machine.

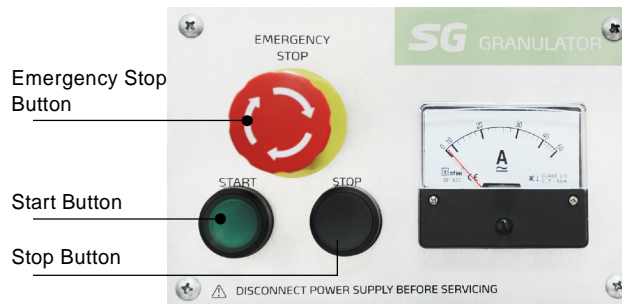

Picture 4-3: Start, Stop and Emergency Stop Buttons

Note: If there are ungrinded crew materials in the feed box or cutting chamber, the granulator shall NOT be stopped, otherwise the crew materials will blockade the rotator and the motor will be overloaded next time you start the machine up.

4.3 Open the Feeding Hopper, Screen and the Storage box



Before opening the feeding hopper, screen and the storage box, turn off the main power switch and the power switch of the granulator.



Be careful! The blade is very sharp, please take care.

4.3.1 Open The Feeding Hopper

- 1) Check if the feeding hopper and pulverizing room have been emptied. After that, turn off the main power supply.
- 2) Loosen the long star screw and open the door.
- 3) Loosen the lock clip of the hopper and open the cover board of the feed box.
- 4) Open the hopper backward.

Note: The feeding hopper is held by pneumatic stick to avoid its dropping when opening it.

4.3.2 Open The Storage Box and Screen

- 1) Turn off the power switch of the granulator.

- 2) Loosen the star screw and open the door.
- 3) Loosen the quick coupling hoop in the end of the outfall pipe and transfer it to one side.
- 4) Loosen the star knob and take out the storage box.
- 5) Screw off the hexagon socket cap screws in the pothook to loosen the pothook.
- 6) Take out the screen bracket and withdraw the screen.

4.4 Close the Screen Bracket, Storage Box and Feeding Hopper

Note: Before opening, clean the interface. Take care! DO NOT be squeezed!

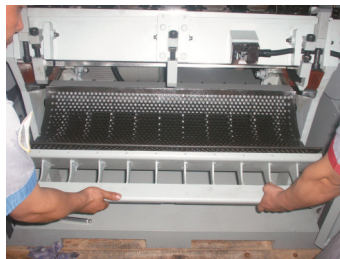

Picture 4-4: Close The Screen Bracket, Storage Box and Feeding Hopper.

4.4.1 Installation of The Screen Bracket and The Storage Box

- 1) Hold to the arc section of the screen bracket and put it in the cutting chamber. Insert the screen bracket to the hinge pin hole seat and then fasten the screw on the press plate.
- 2) Fold down the screen bracket and then install screen.
- 3) Lift up the front end of the screen bracket and push it toward cutting chamber.
- 4) Install the lockup clip close with the screen bracket to fix the bracket.
- 5) Lift up the storage box and insert it into the cutting chamber's groove. Move the back end carefully downwardly.
- 6) Tighten the star handle on both ends of the storage box.

4.4.2 Close The Feed Box

Note: The door must be open; otherwise the feeding hopper cannot be closed.

- 1) Check to ensure there is no powder left in the interface or corners.
- 2) Close the feed box forwardly.
- 3) Lock up the pothook and fix the feed box.

5. Trouble Shooting

5.1 Granulator Can Not Work

- 1) Check if the emergency stop has not been reset. If not, rotate the Button clockwise to reset it.
- 2) Check whether the door is closed. If not, the machine could not be started.
- 3) Check if the feed box is completely closed. If not, the machine could not be started. Then, check the lockup clip after opening the door.
- 4) Check the motor's overload protector. The overload protector in the electrical control box will work if the motor overloads. Test key (A) turn left, press "Reset" key (B) to reset it. Before startup again, check whether there is any powder in the granulator.
- 5) Check the overload protector of the feeding blower's motor. If the feeding blower does not run, the granulator cannot run either. Check the motor protector in the electric control box. If it is closed, the switch will be in "0" positions. Reset it to "1" position, check whether there is any material residue, then re-start the machine. Test key (A) turn to left, press "Reset" key (B) to reset.
- 6) Check the space between blades. The stop will happen or the motor overload protector will work if the blade is very blunt or the space between blades is not correct. The motor overload protector will trip.



5.2 Stop Due to Other Reasons

Connection failure or looseness of safety switch or limit switch can also result in operation failure.

Note: Do not disconnect to safety switch or control switch.

6. Maintenance and Repair

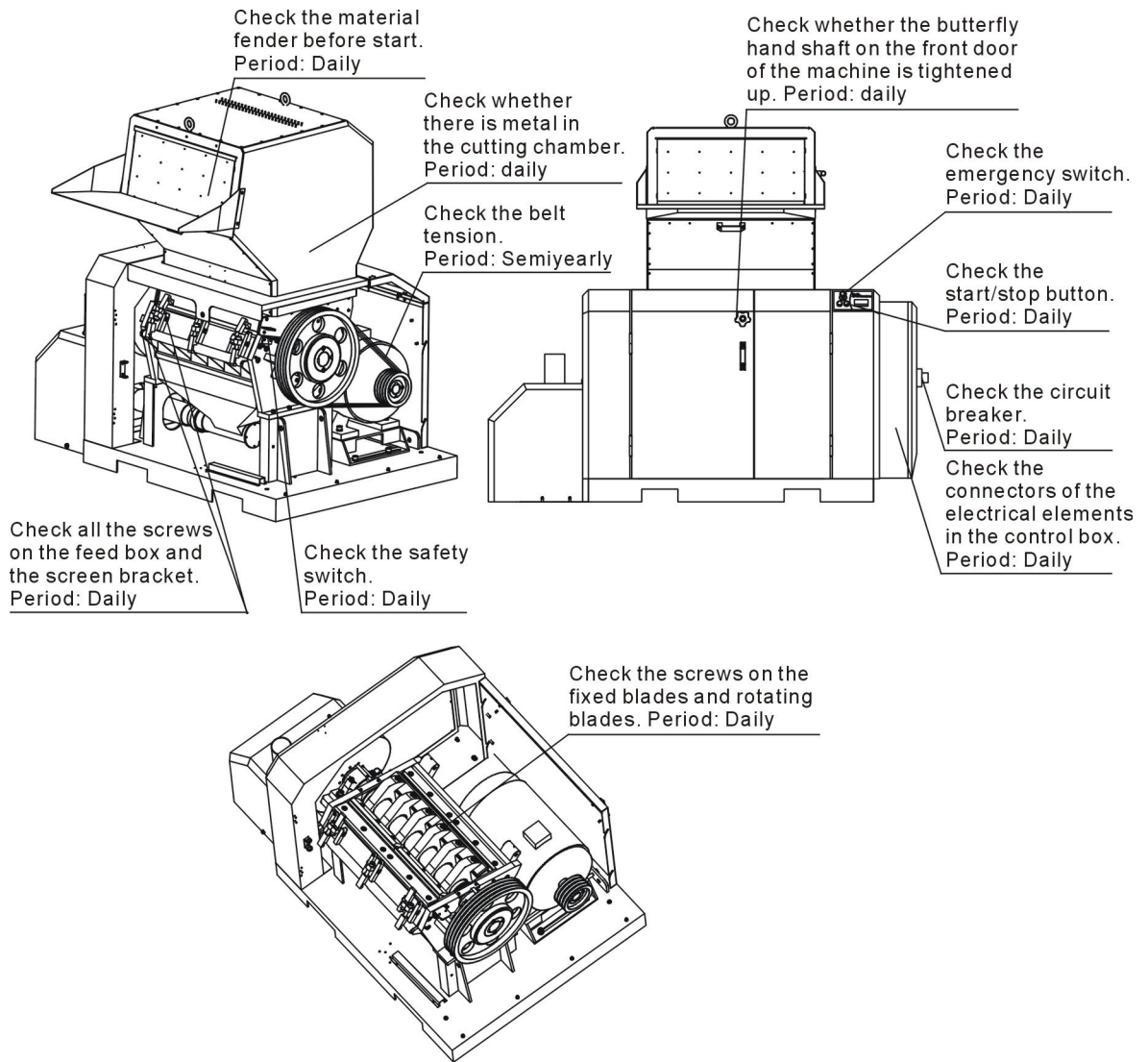

6.1 Repair

The entire repair must be done by professionals to avoid damage to machine and harm to human body.

6.1.1 Dust Separate System Operation and Maintenance

Daily check

Air and dust bags, check if these bags are damaged, if there is any damage, please replace them.

Check if the conveying pipe is damaged ,if it is , please replace it.

Check if the connecting joint had been fixed and sealed.

Check if the dust collection bag is full, if it is ,please dump it Check if the collection barrel is placed right under the dust separator, if there has any deviation , please adjust it.

Check the collection barrel , if it is full, take out the dust removed plastic in time.

Weekly check

Check to see if the wire has any damage and the condition of the wire,if it has any problem , please fix it.

6.1.2 Clean The Dust separate System



Notes!

Clean the machine when the processing material is changed or after every 300-hour running time. Before cleaning, please cut off the power.

- 1) First clean the inner side of the cleaning facilitates.
- 2) It is necessary to check and clean dust separator.
- 3) Move away separator, use high pressure air to blow away its interior granules.
- 4) Clean out the storage hopper and clean its interior.
- 5) Shake the air bag to drop the dust down.
- 6) Assembly the disassembled parts according to reversed order.

6.1.3 Replace the Blades



Caution!

The blade rest shaft of the granulator is balanced. So during blade installation, it will self-rotate due to unbalance. When there is unstable center of gravity, it will self-rotate too.



It must press down the emergency stop button and turn off the main power switch before blade replacement!



Be careful when holding the blades, they are sharp and can cause personal injury. Use protective gloves!

The maintenance, repair and blade replacement, please refer to 3.6 The installation of rotating and fixed blade. After locking of every screws, squeeze the screw fixing agent (LOCTITE 243, blue is suggested) on the connection thread to fasten the screw and avoid screw loosening.



Caution!

During blade dismantlement and replacement, please complete it by oneself. Do avoid other human injury, the blade replacement should be conducted individually!



Caution!

Do not install the cutters by working together, because this could bring personal injury. Use a thick wood block to stop the rotating knives from turning.

Check whether there is damage after blade replacement. If the screen diameter gets larger, change the screen immediately.

1) Remove The Rotating Blades



CAUTION!

To avoid self rotation, block the rotating blade with a thick wood block.

1. Remove the screws and insulation rings.
2. Remove the blades.
3. Clean the installation surface of the blades.

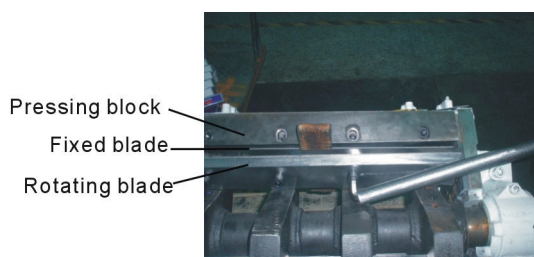

Picture 6-1: Remove The Rotating Blades

2) Remove the fixed blades

1. Revolve the screw of the front fixed blade.
2. Loosen and remove the hexagon socket cap screw.
3. Remove pressing block and blade, clean the blade rest.
4. Loosen and remove the screws of the back blades.
5. Loosen and remove the hexagon socket cap screw again, remove the pressing block and blade. Clean the supporter box.

3) Install the blades

Clean carefully the fixed blades and rotating blades and then install them.



CAUTION!

Each time to replace the blade, the screw and insulation ring must be replaced also.

A: The installation steps with presetting knife jig:

- 1) All blades, including rotating blade and fixed blade, could be adjusted inside the presetting knife jig outside the machine. Put all the blades need to be adjusted, including rotating and fixed blade, inside the presetting knife jig. Regulate the adjusting screw till it touches the presetting knife jig.

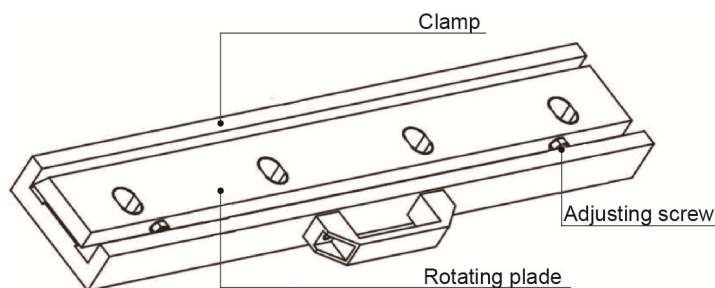

Picture 6-2: Blades Installation Adjusting

- 2) After the rotating and fixed blade adjusted well on the presetting knife jig, put the rotating blade inside the groove of the milled blade rest. Aim the holes on the blade rest, put down the pressing plate and fix the screws till the blade without any shaking (in order to adjust the clearance between the rotating and fixed blade).

- 3) Mount front / back pressing block of the rotating and fixed blade on front /back block, fasten the screw till the blade without any shaking.
- 4) Use the feeler gauge to check the clearance between rotating and fixed blade, the distance is 0.2~0.3mm; Adjust the rotating and fixed blade if it is not within this distance. At last, lock the fixing screw of rotating and fixed blade with torque spanner, for the torque please refer to Table 6-1.

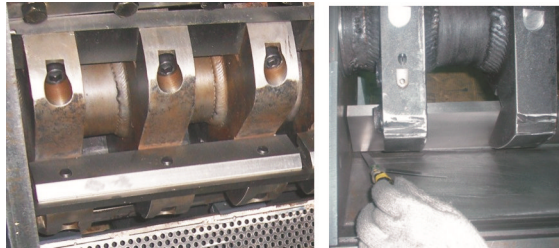

Picture 6-3: Installation of Rotating and Fixed Blade

B: Without presetting knife jig:

- 1) When presetting knife jig is not adopted, firstly adjust the length of one adjusting screw on rotating blade as its total width with blade to $90 \pm 0.07\text{mm}$; then adjust another screw length to the same value, at last lock the nuts and screws.
- 2) Same as the installation with presetting knife jig.



CAUTION!

In order to avoid human injury and machine damage, it must lock up the blade screw tightly.



CAUTION!

The blade clearance can't be too close to avoid blade damage!



CAUTION!

Every time to replace the cutters, the blade, pressing block, screw, blade rest and main shaft should be inspected carefully, to check if there is any damage.

Chart 6-1: Attached form, Cutters and Other Fixing Screw Torque

Threading Type	Threading Specification	Stretching Force FV (N)			Tightening Torque Ma (N.m)		
		Grade -8.8	Grade -10.9	Grade -12.9	Grade -8.8	Grade -10.9	Grade -12.9
Coarse Thread	M4	3900	5750	6700	3.0	4.4	5.1
	M5	6400	9400	11000	5.9	8.7	10
	M6	9000	1320	15500	10	16	18
	M8	16500	24300	28400	25	36	43
	M10	26300	38700	45200	49	72	84
	M12	38400	56500	66000	86	126	145
	M14	62500	77500	90500	135	200	236
	M16	72500	10700	12500	210	310	365
	M18	91000	129000	152000	300	430	600
	M20	117000	166000	195000	425	610	710
	M22	146000	208000	244000	580	820	960
	M24	168000	240000	281000	730	1050	1220
	M27	222000	316000	369000	1100	1550	1800
	M30	269000	384000	449000	1450	2100	2450
Fine Thread	M8×1	18100	26600	31200	27	39	46
	M10×1.25	28300	41600	48700	52	76	90
	M12×1.25	43300	63500	74600	93	135	160
	M12×1.5	40800	60000	70000	89	130	155
	M14×1.5	58600	86000	100000	145	215	255
	M16×1.5	79500	116000	136000	226	330	390
	M18×1.5	108000	152000	177000	340	485	570
	M20×1.5	134000	191000	224000	475	680	790
	M22×1.5	166000	236000	276000	630	900	1050
	M24×2	189000	270000	316000	800	1150	1350
	M27×2	246000	350000	409000	1150	1650	1950
	M30×2	309000	440000	515000	1650	2350	2750

6.2 Installation of Bearing and Blade Rest

- 1) Heat the bearing and lay it to be entrapped into the blade rest. Use 120°C kerosene to heat it up for 5 minutes.
- 2) Fix the low half part of bearing base into both right and left sides of table-board, match the positions of the hole and lock them tightly.
- 3) Put the blade rest inside the granulation chamber and make both ends of its bearing to match with the grooves.

Note: Add some lubricating oil in both bearing and bearing block. Aluminous circlip should be laid between the left bearing and its bearing block.

- 4) Install the shutter ring and bearing cap. Then, lock it up with screws.

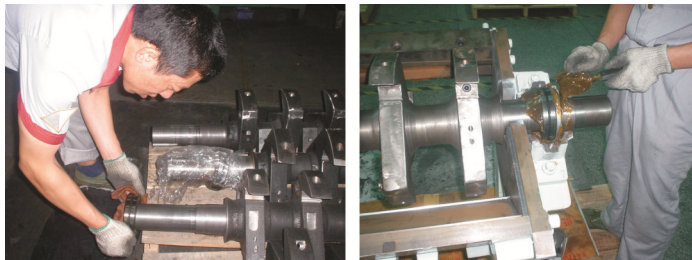

Picture 6-4: Installation of Bearing and Blade Rest

6.3 Installation of Belt Pulley and Motor

6.3.1 SG-3650

- 1) Interpose the key to the key groove and then install the driven wheel.

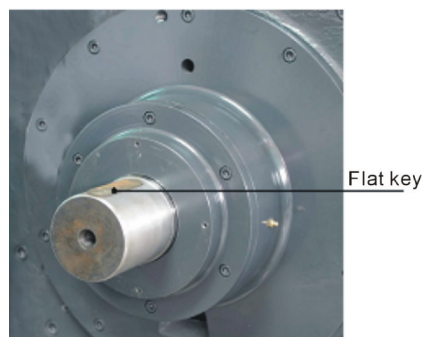

Picture 6-5: Installation of Belt Pulley and Motor 1 (SG-3650)

- 2) Lay lockup ring in the hole of the driven wheel and make both positions of the hole to match each other then screw the hexagon socket cap screw (M12mm×40).
- 3) Adjust the balance of the driven wheel with dial gauge. Stick the dial gauge to the driven wheel and rotate the driven wheel to see whether the value of the in dicator drops within 0~0.1 mm.

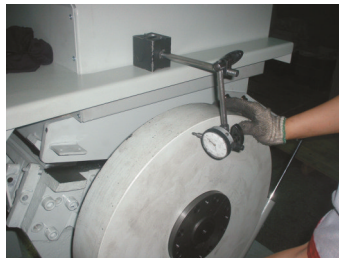

Picture 6-6: Installation of Belt Pulley and Motor 2(SG-3650)

- 4) After balance, screw tightly the 8 hexagon socket cap screws.
- 5) Install the driving wheel in the bearing of the motor and screw the 6 hexagon socket cap screws with the specificity of $\Phi 10\text{mm} \times 35$.
- 6) Lay the motor on the fixing plate to adjust and screw tightly the 4 fixing screws. Push forward to shorten the space between the driving wheel and the driven wheel.



Picture 6-7: Installation of Belt Pulley and Motor 2(SG-3650)

- 7) Adjust the balance of the driving wheel and driven wheel: place spirit level between the driving wheel and the driven wheel to observe whether the mercury column is in the middle. If not, adjust the driving wheel (note: NOT the driven wheel) to make the driven wheel and driving wheel in balance.

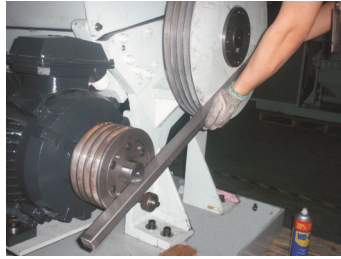

Picture 6-8: Installation of Belt Pulley and Motor 2 (SG-3650)

- 8) Install the belt, push the motor rightward and screw tightly the position adjusting bolt to make the 4 belts be stressed by equal forces. Tighten the belts and screw down the position adjusting bolt.

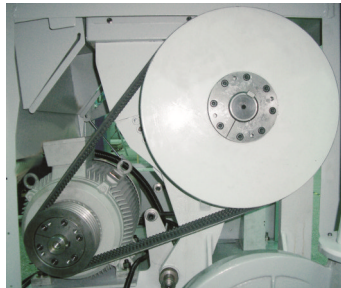

Picture 6-9: Installation of Belt Pulley and Motor 5 (SG-3650)

6.3.2 SG-3675

- 1) Interpose the key to the key groove and then install the driven wheel.

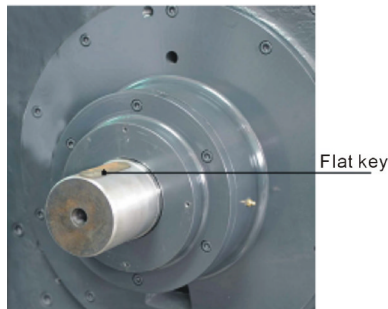

Picture 6-10: Installation of Belt Pulley and Motor 1 (SG-3675)

- 2) Lay lockup ring in the hole of the driven wheel and make both positions of the hole to match each other then screw the hexagon socket cap screw (M12mm×40).
- 3) Adjust the balance of the driven wheel with dial gauge. Stick the dial gauge to the driven wheel and rotate the driven wheel to see whether the value of the indicator drops within 0~0.1 mm.

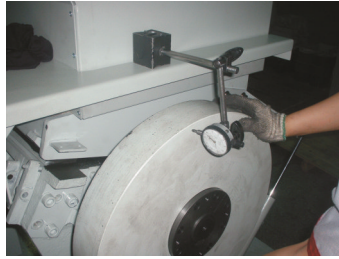

Picture 6-11: Installation of Belt Pulley and Motor 2 (SG-3675)

- 4) After balance, screw tightly the 8 hexagon socket cap screws.
- 5) Install the driving wheel in the bearing of the motor and screw the 6 hexagon socket cap screws with the specificity of $\Phi 10\text{mm} \times 35$.
- 6) Lay the motor on the fixing plate to adjust and screw tightly the 4 fixing screws. Push forward to shorten the space between the driving wheel and the driven wheel.
- 7) Adjust the balance of the driving wheel and driven wheel: place spirit level between the driving wheel and the driven wheel to observe whether the mercury column is in the middle. If not, adjust the driving wheel (note: NOT the driven wheel) to make the driven wheel and driving wheel in balance.



Picture 6-12: Installation of Belt Pulley and Motor 3 (SG-3675)

- 8) Install the belt, push the motor rightward and screw tightly the position adjusting bolt to make the 4 belts be stressed by equal forces. Tighten the belts and screw down the position adjusting bolt.



Picture 6-13: Installation of Belt Pulley and Motor 4 (SG-3675)

6.4 Installation of Storage Box, Screen and Screen Bracket

- 1) Put the screen bracket into the cutting chamber and move backward the screen bracket and fit the spindle into circular arc of the boss, then install the boss pressing plate and tighten the screw.
- 2) Detach the screen bracket and put the screen in it.
- 3) Lift up the screen bracket again and lock it closely with the very front fixing pothook.

Note! The screw must be tightened in this step; otherwise, a deformation will occur in the screen bracket and thus results in the break of the screws.

- 4) Install the storage box. Uplift the storage box and plug the box rear into the grooves of the side plates, push it forward until the end.
- 5) Tighten the star handle on the storage box.

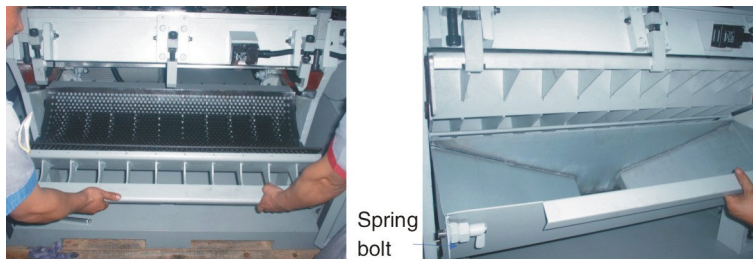

Picture 6-14: Installations of Storage box, Screen and Screen Bracket.

6.5 Installation of Feed Box and Feed Inlet

- 1) Open the front doors and the back cover.
- 2) Hoist the feed box to put it on the cutting chamber carefully to match.

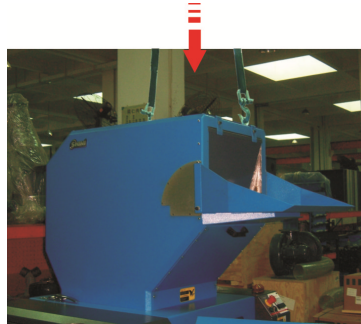

Picture 6-15: Installation of Feed Box and Feed Inletv 1

- 3) Mount both side location pin and lock up with lockup screw.



location pin Stop screw

Picture 6-16: Installation of Feed Box and Feed Inletv 2

- 4) Lockup the two pothooks in front of feed box.

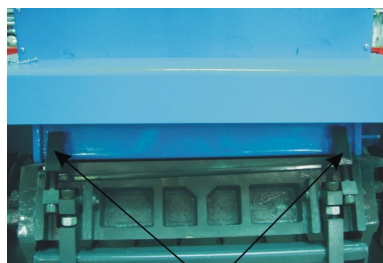

Pothook

Picture 6-17: Installation of Feed Box and Feed Inletv 3

- 5) Load the pneumatic spring fixing block to the lower left side of the feed box.
- 6) Load the pneumatic spring and make its lower end link to the fixing pole of the electric machine.

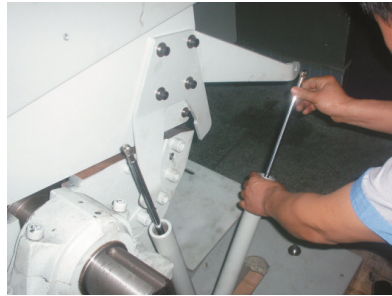

Picture 6-18: Installation of Feed Box and Feed Inletv 4

- 7) Prop up the feed box and install the match scaffold of the hopper base.
- 8) Install stainless fixing blocks on both sides of the feed box.
- 9) Align the positions of the holes of the feed inlet and stainless fixing blocks. Tighten with screws.



Picture 6-19: Installation of Feed Box and Feed Inletv 5

6.6 Transferring



Maintenance or repair the transmission belts after pressing down the emergency stop button or main power switch!

6.6.1 Daily maintenance of V belts

There are four V belts according to motor power.

- 1) Check the V belts
Check V belts' tensility after a full-load operation for 20-30 hours. And then check its abrasion condition.
- 2) Check V belts' tensility every 6 months.
Remove the upper panel in the back end of the granulator. Rotate the V belts for several circles to see if there is any damage.

Note: Pinch rist! Do not place your hands between wheels and the belts.

If it is necessary, check the belt's tensility via enforce extra force (75N) and measure its excursion. This extra force is determined by power and frequency of the motor. More Details to see the following table.

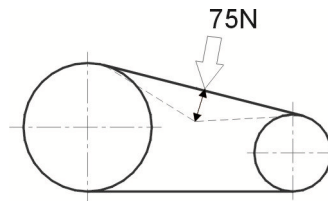

Picture 6-20: Daily Maintenance of V Belts

Motor 50Hz	18.5/22kW	30/37kW	45-55kW
New belt	15mm	14mm	15mm
Old belt (Six- month later))	19mm	19mm	19mm
Motor 60Hz	18.5/22kW	30/37kW	45-55kW
New belt	18mm	17mm	16mm
Old belt (Six- month later)	23mm	23mm	20mm

6.6.2 Adjustments of V belts

- 1) Remove the upper panel and feeding plate in the back end of the granulator and open the box door.
- 2) Open the quick coupling clip in the end of the outlet pipe and remove the storage box.
- 3) Adjust the belt's tensility via changing the space between the driving wheels and the driven wheels with two moving screws.
- 4) Lock up the two moving screws. Recheck the belts' tensility after a full-load operation for 20-30 hours.

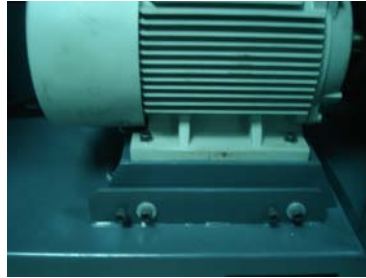

Picture 6-21: Adjustments of V Belts

6.7 Lubrication

6.7.1 Lubricating oils

Xin Chang Long: FX-00

FX-000

Bp: BP Grease LGEP 2

ESSO: Beacon Ep2, Beacon EP2

Mobil: Mobilux EP2

Shell: Shell Alvania EP2

Texaco: Multifak Ep2, Novotex Grease EP2

6.7.2 Please grease the bearing with lubricating oils periodically

Inject lubricating oil via throat with an oil greaser. If the granulator is not used for a long time, please grease anti-rust oil in blade rest, fixed blade, rotating blade, cutting chamber and screws to avoid dust.

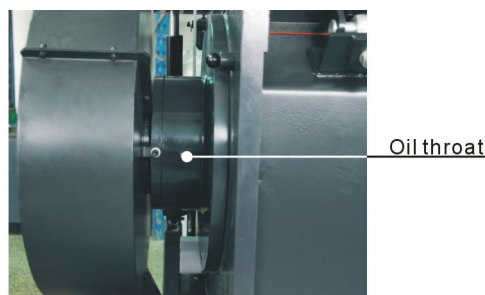

Picture 6-22: Oil Throat

6.8 Cleaning



CAUTION: The blade may do harm to human body when opening the feeding hopper!

- 1) Check whether the feed box is emptied before stopping the machine.
- 2) Clean the exterior surface of the feed box.
- 3) Turn off the main power switch.
- 4) Clean the shutter of the feed box with a dust separator.
- 5) Open the door of the granulator.
- 6) Loosen the lockup clip and then open the feed box backWardly.

Note: The feed box is held by pneumatic spring, therefore it cannot fall down.

- 7) Clean the interior surface of the feed box.
- 8) Remove the quick coupling clip from one end of the pipe, loosen the star knob on the storage box.
- 9) Uninstall the storage box.

Note: Lift the storage box in both hands so it would not fall down. Fold down the front end of the storage box and draw it forwardly; lift it and push it backWardly at the same time; remove it forwardly and upwardly.

- 10) Loosen the lock wiring in the screen bracket and remove the screen bracket.

Note: Lift the screen with hands so it would not fall down.

- 11) Take out the screen.
- 12) Hold to the screen and take it out outwardly.
- 13) Clean the storage box, screen bracket and the screen.
- 14) Clean both surfaces of the cutting chamber.
- 15) Clean every transmission pipe, blower, and cyclone dust separator;
- 16) Clean the wheels with bright dust-precipitator.

Reinstall after cleaning

Note: Take care not to be squeezed when closing the door!

- 1) Install the screen bracket.

- 2) Put the screen bracket in the cutting chamber and insert the screen bracket to the hinge pin hole seat and then fasten the screw on the press plate.
- 3) Fold down the screen bracket and install the screen
- 4) Hold to handle and push the front end of the screen bracket in the direction of cutting chamber. Fix the screen bracket via connect the pothook to the screen bracket.
- 5) Install the storage box. Lift it up to make its tail into the groove of the cutting chamber. Move slowly the back end of the storage box and let it slide until stop; fasten the star knob on the storage box.
- 6) Install the quick coupling clip at the end of the outlet pipe.
- 7) Close the feed box.

Note: Before closing the feed box the door must be open; check if there is any residual powder left in the interface and edges; close and fix the feed box with pothook.
- 8) Install the rubber shutter of the feed box.
- 9) Tighten the lockup buckle and close the door.
- 10) Check if the feed box is emptied.
- 11) Open the main power switch.
- 12) Start the machine.

6.9 Maintenance Schedule

6.9.1 About the Machine

Model _____ SN _____ Manufacture date _____

Voltage _____ Φ _____ V Frequency _____ Hz Power _____ kW

6.9.2 Check after Installation

- Check if pipe connections are firmly locked by clips.
- Check the gap between fixed blade and rotating blade. (0.2~0.3mm).
- Check the rotating balance of the belt wheel.

Electrical Installation

- Voltage: _____ V _____ Hz
- Specs of the fuse: 1 Phase _____ A 3 Phase _____ A
- Check phase sequence of the power supply.
- Check the rotating direction of the conveying blower.

6.9.3 Daily Check

- Check main power switch.
- Check emergency stop button.
- Check start / stop button.
- Check material check plate (strip) is perfect or not.
- Check whether emergency stop and safety switch works normally.
- Clean screen and feeding hooper.
- Check whether start, stop and power switches are normal.

6.9.4 Weekly Check

- Check all the electrical cables.
- Check if there are loose connections of electrical components.
- Check blade condition.
- Check whether set screws in fixed and rotate blades are under looseness.
- Check if there is abnormal noise, vibration and heat in reduction gear.
- Check the cracking window

6.9.5 Monthly Check

- Check the status of the belt.
- Check the overload protection function of the motor.
- Check motor reversed running function.
- Check the tightness of the blades.
- Check whether clamp ring of pulley is fastened.
- Check belt tension.

6.9.6 Check Half-yearly or Every 1000 Running Hours

- Check or replace lubrication for gear motor.
- Check lubrication of bearing.
- Check coupling.
- Evaluation of the machine condition.

6.9.7 3 year Checking

- PC board renewal.
- No fuse breaker renewal.