

SIC-W

Water-cooled Water Chillers

Date: Mar., 2022

Version: Ver.D (English)



Contents

1. General Description	6
1.1 Coding Principle.....	7
1.2 Features.....	7
1.3 Technical Specifications	9
1.3.1 External Dimensions	9
1.3.1 Specification List.....	11
1.4 Safety Regulations.....	13
1.4.1 Security Labels.....	13
1.5 Exemption Clause.....	14
2. Structural Features and Working Principle.....	15
2.1 Main Functions.....	15
2.1.1 Working Principle.....	15
2.2 Main Components and Functions	17
2.2.1 Compressor.....	17
2.2.2 Condenser.....	17
2.2.3 Drying Filter	17
2.2.4 Thermal Expansion Valve.....	18
2.2.5 Evaporator.....	18
2.2.6 High and Low Pressure Controller.....	19
2.3 Options	19
2.3.1 Refrigerant Indicator.....	19
2.3.2 Liquid Pipe Solenoid Valve.....	19
2.3.3 Hot-gas Bypass Valve	20
2.3.4 Flow Switch	20
2.3.5 Liquid Level Indicator.....	20
2.4 Main Electrical Components	22
2.4.1 Thermal Overload Relay.....	22
3. Installation and Debugging.....	23
3.1 Installation Notices.....	23
3.2 Installation Diagram	25
3.3 Power Connection.....	25

4. Application and Operation	26
4.1 Panel Diagram	26
4.2 Common Screens	26
4.3 Quick Operation	27
4.4 Startup	28
4.5 Shutdown	28
4.6 User Menu	29
4.6.1 Parameter Operation	29
4.6.2 User Setting	29
4.6.3 Machine Set	30
4.6.4 System Time Set	30
5. Trouble-shooting	31
6. Repair and Maintenance	35
6.1 Filling the Refrigerant.....	38
6.2 Components Maintenance	39
6.2.1 Condenser.....	39
6.2.2 Evaporator.....	40
6.3 Maintenance Schedule	41
6.3.1 About the Machine.....	41
6.3.2 Check after Installation	41
6.3.3 Daily Checking	41
6.3.4 Weekly Checking.....	41
6.3.5 Montly Checking.....	41
6.3.6 Trimonthly Checking.....	42
6.3.7 Half-yearly Checking	42
6.3.8 Yearly Checking	42
6.3.9 3 year Checking	42

Table Index

Table 1-1: Specifications List (1)	9
Table 1-2: Specifications List (2)	10
Table 1-3: Specification List (1)	11

Table 1-4: Specifications List (2).....	12
Table 6-1: SIC-W Series Filling Quantity	38

Picture Index

Picture 1-1: Outline Dimensional Drawing	9
Picture 2-1: Working Principle Diagram	15
Picture 2-2: Compressor	17
Picture 2-3: Condenser	17
Picture 2-4: Drying Filter	18
Picture 2-5: Thermal Expansion Valve.....	18
Picture 2-6: Evaporator	19
Picture 2-7: High and Low Pressure Controller.....	19
Picture 2-8: Refrigerant Indicator	19
Picture 2-9: Liquid Pipe Solenoid Valve	20
Picture 2-10: Hot-gas By-pass Valve	20
Picture 2-11: Flow Switch	20
Picture 2-12: Liquid Level Indicator.....	21
Picture 2-13: Thermal Overload Relay.....	22
Picture 3-1: Machine Installation Location	25
Picture 6-1: Fill in the Refrigerant (1)	38
Picture 6-2: Fill in the Refrigerant (2)	38
Picture 6-3: Water Drainage Port.....	40

1. General Description



Please read through this operation manual before using and installation to avoid damage of the machine and personal injuries.

SIC-W series water-cooled chiller adopts single-stage vapour compressed circuit, with compressor overload protection, pump overload protection, phase reverse alarm, anti-freezing protection, high & low pressure protector, which features stable performance and long service life. It can quickly cool down, and maintain stable temperature to meet the requirements of customers. This series of products work following the heating and cooling exchange principle, which is an indispensable device for cooling applications in modern industry.



Model: SIC-5W

1.1 Coding Principle

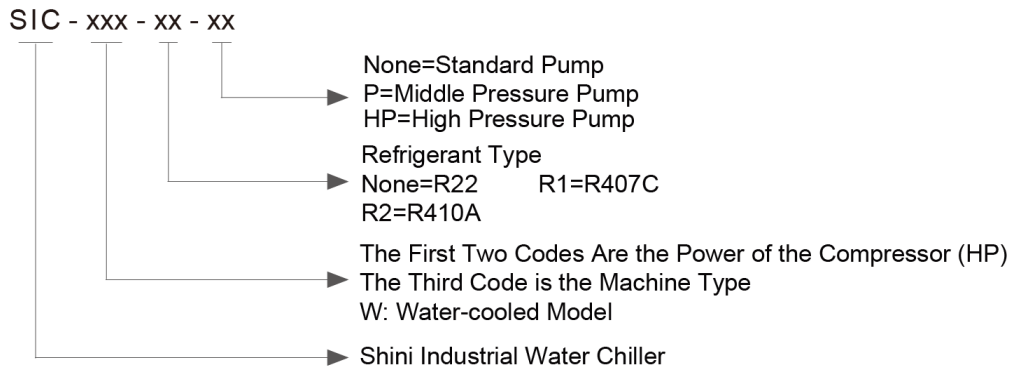

1.2 Features

Standard configuration

- Cooling range 7~35°C
- Stainless steel insulated water tank and evaporator
- Anti-freezing protector
- Adopt R22 refrigerant, and cooling effect
- The refrigeration system adopts high and lower pressure controller for protection
- Low pressure pumps are standard configurations.
- Compressor and pump both have overload protector.
- Adopt Italian temperature controller that can maintain the accuracy of $\pm 0.1^{\circ}\text{C}$.
- All adopt branded compressors with low noise, high efficiency and long service life.
- SIC-W adopts fin style condenser design without any need of cooling water for excellent heat transfer and rapid cooling.

Accessory option

- Medium and high pressure pumps are optional to meet different water pressure requirements.
- Water tank level sensor is optional to check whether the water level is in normal condition.
- Hot-gas bypass valve is optional that can maintain the temperature control accuracy up to $\pm 1^{\circ}\text{C}$;
- SIC-3W-5W can choose 1 / 2 "4-in 4-out water flow regulator
- The liquid pipe solenoid valve is optional to prevent evaporator freezing by

cutting the refrigerant immediately after downtime.

- Refrigerant indicator can be opted to detect the refrigerant and ensure its quality and water ratio.
- Optional flow switches to detect the chilled water flow.

All service work should be carried out by a person with technical training or corresponding professional experience. The manual contains instructions for both handling and servicing. Chapter 6, which contains service instructions intended for service engineers. Other chapters contain instructions for the daily operator.

Any modifications of the machine must be approved by SHINI in order to avoid personal injury and damage to machine. We shall not be liable for any damage caused by unauthorized change of the machine.

Our company provides excellent after-sales service. Should you have any problem during using the machine, please contact the company or the local vendor.

Shini Hotline Service:

Headquarter and Taipei factory:

Tel: + 886 (0)2 2680 9119

Shini Plastics Technologies (Dongguan), Inc.:

Tel: +86 (0)769 8331 3588

Shini Plastics Technologies (Pinghu), Inc.:

Tel: +86 (0)573 8522 5288

Shinden Precision Machinery (Chongqing), Inc.:

+86 (0)23 6431 0898

1.3 Technical Specifications

1.3.1 External Dimensions

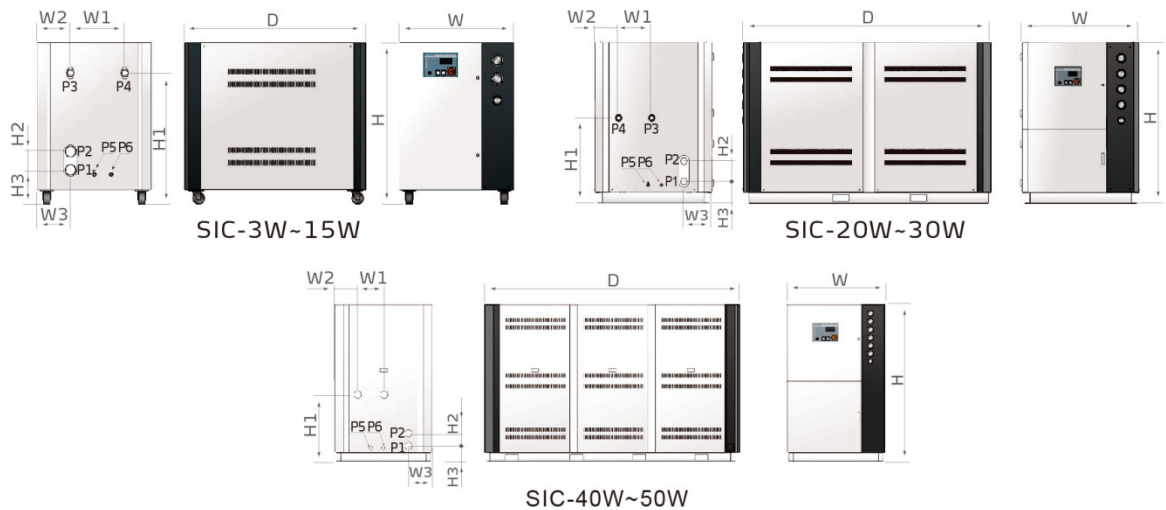

Picture 1-1: Outline Dimensional Drawing

Table 1-1: Specifications List (1)

Model	SIC-3W	SIC-5W	SIC-8W	SIC-10W	SIC-12.5W	SIC-15W
H(mm)	970	970	1050	1050	1200	1200
H1(mm)	790	790	910	910	1078	1078
H2(mm)	91	91	140	140	140	140
H3(mm)	207	207	225	225	308	308
W(mm)	550	550	830	830	865	865
W1(mm)	273	273	370	370	459	459
W2(mm)	164	164	230	230	202	202
W3(mm)	164	164	230	230	162	162
D(mm)	1080	1080	1200	1200	1470	1470
P1 cooling water inlet (inch)	1	1 1/2	1 1/2	2	2	2 1/2
P2 cooling water outlet (inch)	1	1 1/2	1 1/2	2	2	2 1/2
P3 freezing water inlet (inch)	1	1	1 1/2	1 1/2	2	2
P4 freezing water outlet (inch)	1	1	1 1/2	1 1/2	2	2
P5 water tank outlet (inch)	1 1/2	1 1/2	1 1/2	1 1/2	1 1/2	1 1/2
P6 water tank overflow port (inch)	1 1/2	1 1/2	1 1/2	1 1/2	1 1/2	1 1/2
Weight(kg)	230	290	400	410	610	640

Table 1-2: Specifications List (2)

Model	SIC-20W	SIC-25W	SIC-30W	SIC-40W	SIC-45W	SIC-50W
H(mm)	1450	1450	1450	1760	1760	1760
H1(mm)	765	765	765	910	1078	170
H2(mm)	200	200	200	140	140	120
H3(mm)	190	190	200	190	190	190
W(mm)	1055	1055	1055	1100	1100	1100
W1(mm)	300	300	300	370	459	180
W2(mm)	295	295	215	229	202	325
W3(mm)	205	205	205	230	162	505
D(mm)	2235	2235	2235	2870	2870	3285
P1 cooling water inlet (inch)	2 1/2	2 1/2/2 1/2	2 1/2	2 1/2	2 1/2	2 1/2
P2 cooling water outlet (inch)	2 1/2	2 1/2/2 1/2	2 1/2	2 1/2	2 1/2	2 1/2
P3 freezing water inlet (inch)	2	2	2 1/2	2 1/2	2 1/2	2 1/2
P4 freezing water outlet (inch)	2	2	2 1/2	2 1/2	2 1/2	2 1/2
P5 water tank outlet (inch)	1 1/2	1 1/2	1 1/2	1	1	1
P6 water tank overflow port (inch)	1 1/2	1 1/2	1 1/2	1	1	1
Weight(kg)	750	760	800	1200	145	1750

1.3.1 Specification List

Table 1-3: Specification List (1)

Item/ Parameters		Model		SIC-3W	SIC-5W	SIC-8W	SIC-10W	SIC-12.5W	SIC-15W	
Refrigerant Capacity ¹⁾	kW			8.25	13.8	21.8	29.1	33	43	
	Kcal/hr			7,095	11,868	18,748	25,026	28,380	36,980	
Compressor	Power (50Hz/60Hz)	kW		2.04	3.32	4.91	6.46	7.33	9.5	
		HP		3	5	8	10	12.5	15	
Refrigerant	Weight (kg)			1.5	2.5	3.8	5	7	8.5	
	Control Mode		Thermostatic expansion valve							
	Type		R22							
Evaporator	Type		Tube-in-shell style							
Condenser	Type		Tube-in-shell style							
	In/out water pipe(inch)			1	1 ¹ / ₂	2	2 ¹ / ₂			
	Cooling water flow (L/min)			56	65	90	100	130	160	
Water Tank Capacity (L)				50		90		105		
Pump ²⁾ (50Hz)	Power (kW)				0.75/0.75/1.1		1.1		1.1/1.5/2.2	
	Pump Flow (L/min)				50/83/67		80/100/89		130/150/133	
	Working Pressure (kgf/cm ²)				2.0/2.6/3.8		2.0/2.6/3.5		2.0/3/4.2	
Total Power (kW) ³⁾				2.79	4.07	6.01	7.56	8.43	10.6	
Pipe	Chilled Water Outlet				1	1 ¹ / ₂	2			
	Chilled Water Inlet				1	1 ¹ / ₂	2			
Coupling (inch)	Water Tank Outlet		1/2							
	Water Tank Overflow Port		1/2							
Protective Devices	Compressor		Overload relay							
	pump		Overload relay							
	Chilled Water Circuit		High and low pressure switch/anti-freeze switch							
	Water Circuit		Flow switch (optional) / water tank level sensor (optional) / bypass valve							
Power(VAC) ⁴⁾		3Φ, 400VAC, 50HZ								
Measures Exchange				1kW=860 kcal/hr	1RT=3,024kcal/hr	10,000Btu/hr=2,520kcal/hr				

We reserve the right to change specifications without prior notice.

Note:

- 1) Refrigeration capacity is measured based on the flow 0.172 m³ / (h.k W) and the outlet temperature (7°C) of chilled water under the environment temperature of 35°C.
- 2) Low pressure pump is for domestic and Southeast Asia export, customers can change for medium pressure pumps (use P for short; e.g.: SIC-5A-P) or high pressure pumps (use HP for short; e.g.: SIC-5A-HP), specific parameters in turn as shown above.
- 3) Pump power is included in total power.
- 4) Special orders of machine voltage can be acceptable according to customers' requests.

Table 1-4: Specifications List (2)

Item/ Parameters		Model						
		SIC-20W	SIC-25W	SIC-30W	SIC-40W	SIC-45W	SIC-50W	
Refrigerant Capacity ¹⁾¹	kW	58.2	66	86	115.1	129	132	
	Kcal/hr	50,052	56,760	73,960	98,986	110,940	113,520	
Compressor	output power	kW	12.92	14.66	19	25.46	28.5	29.32
		HP	20	25	30	40	45	50
Refrigerant	Weight (kg)	10	14	17	20	25	34	
	Control Mode	Thermostatic expansion valve						
	Type	R22						
Evaporator	Type	Tube-in-shell style						
Condenser	Type	Tube-in-shell style						
	Inlet/outlet water pipe (inch)	2 ¹ / ₂			2 ¹ / ₂ × 2			
	Cooling water flow (L/min)	220	270	330	480	500	600	
Water Tank Capacity (L)		270			700			
Water pump 2) (50Hz)	Power (kW)	2.2 / 3 / 4		4 / 3 / 4		4 / 4 / 5.5		
	Pump flow (L/Min)	200 / 300 / 300		300 / 300 / 300		533 / 366 / 367		
	Pump pressure (kgf/cm ²)	2.5 / 3 / 4.2			2.7 / 3.4 / 4.3			
Total Power (kW) ³⁾		15.12	16.86	23	29.46	32.5	33.32	
Pipe Coupling (inch)	Chilled Water Outlet	2		2 ¹ / ₂		2 ¹ / ₂		
	Chilled Water Inlet	2		2 ¹ / ₂		2 ¹ / ₂		
	Water Tank Outlet	1/2			1			
	Water Tank Overflow Port	1/2			1			
Protective Devices	Compressor	Overload relay						
	pump	Overload relay						
	Chilling Water Circuit	High and low pressure switch/anti-freeze switch						
	Water Circuit	Flow switch (optional) / water tank level sensor (optional) / bypass valve						
Power(VAC) ⁴⁾		3Φ, 400VAC, 50HZ						
Measures Exchange		1kW=860 kcal/hr		1RT=3,024kcal/hr	10,000Btu/hr=2,520kcal/hr			

We reserve the right to change specifications without prior notice.

Note:

- 1) Refrigeration capacity is measured based on the flow 0.172 m³ / (h.k W) and the outlet temperature (7°C) of chilled water under the environment temperature of 35°C.
- 2) Low pressure pump is for domestic and Southeast Asia export, customers can change for medium pressure pumps (use P for short; e.g.: SIC-5A-P) or high pressure pumps (use HP for short; e.g.: SIC-5A-HP), specific parameters in turn as shown above.
- 3) Pump power is included in total power.
- 4) Special orders of machine voltage can be acceptable according to customers' requests.

1.4 Safety Regulations

Operation should be carried out according to the safety regulations this manual to avoid damage of the machine and personal injuries.

Abide by the following regulations during operation.

1.4.1 Security Labels



Attention!

Installation of the device is allowed only to the professional electrician.
Before maintaining and repairing the device, be sure to turn off the main switch and control switch.



Warning!

High Voltage!

This label is posted on enclosure of the electrical control cabinet!



Warning!

Be careful!

Pay more attentions at the places where this sign is attached!





Attention!

Drain the water inside when power off at the cold day to avoid freezing!



Attention!

No need for regular inspection because all the electrical parts in the control unit are fixed tightly!

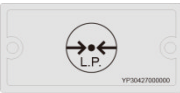
	<p>Pump pressure gauge: display actual pressure of the freezing water system.</p>
	<p>High pressure gauge: display the high pressure of the refrigerant system.</p>
	<p>Low pressure gauge: display the low pressure of the refrigerant system.</p>

1.5 Exemption Clause

The following statements clarify the responsibilities and regulations born by any buyer or user who purchases products and accessories from Shini (including employees and agents).

Shini is exempted from liability for any costs, fees, claims and losses caused by reasons below:

1. Any careless or man-made installations, operation and maintenances upon machines without referring to the Manual prior to machine using.
2. Any incidents beyond human reasonable controls, which include man-made vicious or deliberate damages or abnormal power, and machine faults caused by irresistible natural disasters including fire, flood, storm and earthquake.
3. Any operational actions that are not authorized by Shini upon machine, including adding or replacing accessories, dismantling, delivering or repairing.
4. Employing consumables or oil media that are not appointed by Shini.

2. Structural Features and Working Principle

2.1 Main Functions

SIC-W air-cooled water chillers include consists of four main components, which are compressor, condenser, thermostatic expansion valve, and evaporator. The system adopts single-stage vapour compressed refrigeration system, which uses refrigerant gas-liquid conversion to absorb and release heat, thus achieving the cooling effect.

2.1.1 Working Principle

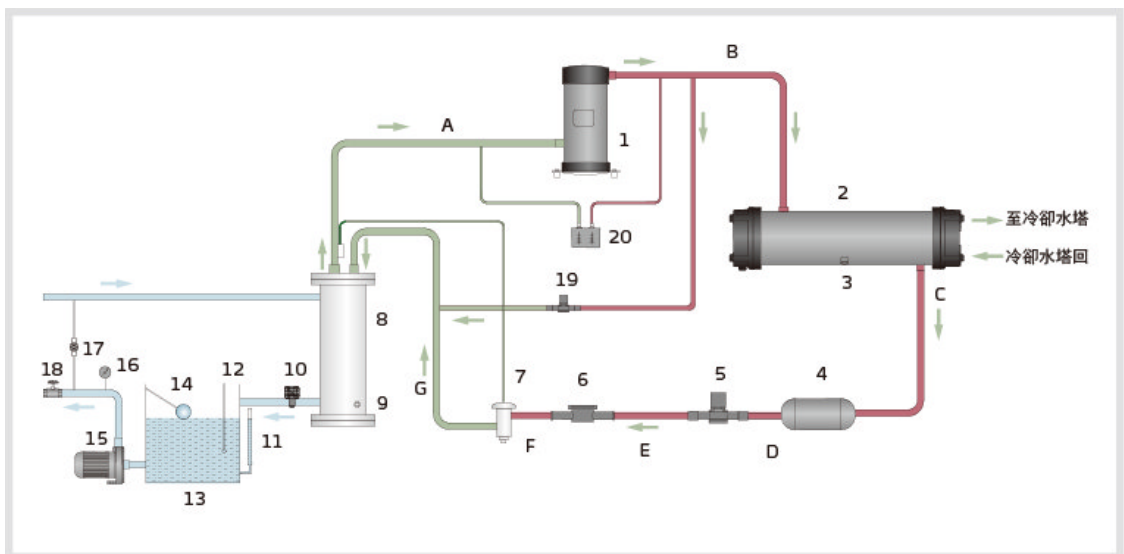

- | | | |
|------------------------------------------|-------------------------------------------|------------------------------------------------------|
| 1. Compressor | 8. Evaporator | 15. Pump |
| 2. Tube-in-shell condenser | 9. Anti-freezing switch | 16. Water pressure gauge |
| 3. Fudible plug | 10. Flow switch (option) | 17. By-pass valve |
| 4. Drying filter | 11. Water level liquid indicator (option) | 18. Sluice valve (for middle and high pressure pump) |
| 5. Liquid pipe solenoid valve (optional) | 12. Temp. sensor | 19. Hot-gas by-pass valve (option) |
| 6. Refrigerant indicator(optional) | 13. Water tank | 20. Pressure controller |
| 7. Expansion valve | 14. Float ball switch | |

Picture 2-1: Working Principle Diagram

When the machine is started, compressor (1) starts working. Refrigerant is compressed into high pressure and high temperature gas in the process from B to C to enter the condenser 2 to exchange heat with the air, which changes from gas to liquid and the heat is taken away by the air. In the C-D-E-F process, the liquid

refrigerant from the condenser through the drying filter 4 that flows to the liquid pipe solenoid valve 5 and refrigerant indicator 6 after drying and impurity filtering, and finally reaches the expansion valve 7. In the F-G process, the temperature of high pressure liquid refrigerant decreases after thermal expansion valve throttling and depressurizing. In the G-A process, the low pressure and low temperature refrigerant exchanges heat with the chilled water through the evaporator 8, and the temperature of cooling the chilled water reach the set value; The low temperature gas refrigerant from the evaporator returns to the compressor, which circulates in this way.

Hot-gas bypass function: when the temperature of chilled water reaches the set temperature, the compressor continues to work. When the temperature drops to the set temperature of the hot gas bypass valve, the hot gas bypass valve opens. Part of the compressed high-temperature and high-pressure refrigerant directly reaches the evaporator through the hot gas bypass valve, which neutralizes some refrigerants and returns the compressor (without passing the condenser). The refrigeration system achieves the balanced load and cooling capacity through the hot-gas bypass valve, so that the compressor can work all the time while keeping chilled water temperature accuracy at $\pm 1^{\circ}\text{C}$.



Attention!

The electrical temperature controller of this water chiller has delayed start function, and our company set the compressor start after three minutes.

2.2 Main Components and Functions

2.2.1 Compressor

- 1) It compresses and conveys the refrigerant vapor that results in low and middle of the evaporator, and middle and high pressure of the refrigerant, which is the core part of whole system.
- 2) Our company produces scroll and piston compressors.
- 3) The power of common compressors is 25%-30% cooling capacity of the water chiller.



Picture 2-2: Compressor

2.2.2 Condenser

- 1) It is the heat output device, which can discharge the heat absorbed by the refrigerant in the evaporator and the heat converted by the compressor consumption to the cooling medium.
- 2) Our company uses the air-cooled condenser (Tube-fin style).

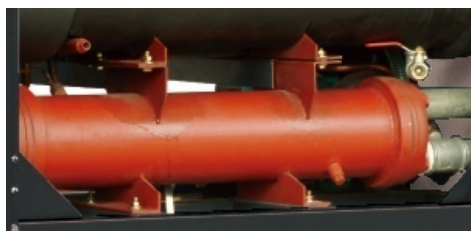

Picture 2-3: Condenser

2.2.3 Drying Filter

- 1) Drying filter function: Remove the impurities in the refrigerant, and absorb the free moisture in the refrigerant to prevent ice blocked in the narrow section of the pipeline (especially at the thermal expansion valve port).

- 2) The filter size is usually selected according to the refrigerant pipe diameter.
- 3) It is mounted in front of the thermal expansion valve to protect the valve's tightness



Picture 2-4: Drying Filter

2.2.4 Thermal Expansion Valve

- 1) The thermostatic expansion valve can throttle and depressurize the refrigerant and regulate the refrigerant flow into the evaporator.
- 2) The heat expansion valve is installed in front of the evaporator.



Picture 2-5: Thermal Expansion Valve

2.2.5 Evaporator

- 1) The evaporator is a device that outputs the refrigerant, which absorbs the heat of the cooled object in the evaporator, so as to achieve the refrigerating purpose.
- 2) Our company uses the horizontal shell and tube evaporator.

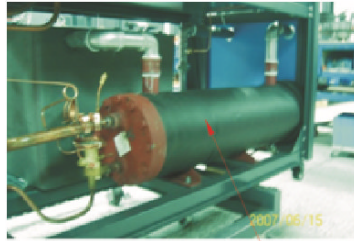

Evaporator

Picture 2-6: Evaporator

2.2.6 High and Low Pressure Controller

- 1) The high and low pressure controller is used to control the working pressure at the compressor air inlet and outlet.
- 2) The high-pressure controller is set to 25bar, and the low-pressure controller is set to 2bar.
- 3) It will give the alarm when the compressor outlet air pressure is higher than 25bar, or the compressor suction port is lower than 2bar.

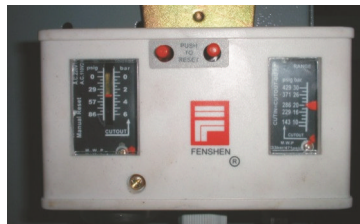

Picture 2-7: High and Low Pressure Controller

2.3 Options

2.3.1 Refrigerant Indicator



Picture 2-8: Refrigerant Indicator

- 1) The refrigerant indicator is used to detect whether the refrigerant is filled appropriately.
- 2) The refrigerant indicator is used to detect the water ratio of the system.

2.3.2 Liquid Pipe Solenoid Valve



Picture 2-9: Liquid Pipe Solenoid Valve

Cut off the refrigerant supply circuit immediately after shutdown to prevent the evaporator from freezing.

2.3.3 Hot-gas Bypass Valve



Picture 2-10: Hot-gas By-pass Valve

It is used for bypass refrigerant gas at low temperature to avoid compressor frequent start-up for accurate temperature control.

2.3.4 Flow Switch



Picture 2-11: Flow Switch

The flow switch is adopted to avoid system damage caused by the cold water circulation failure of the water chiller.

2.3.5 Liquid Level Indicator

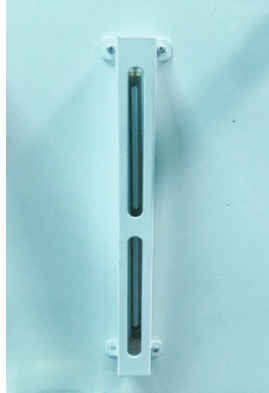

Picture 2-12: Liquid Level Indicator

With the liquid level indicator, it can check whether the water level in the tank is in normal range.

2.4 Main Electrical Components

2.4.1 Thermal Overload Relay

When delivers the machine, the thermal relay is set to the manual reset mode. So when the system indicates motor overload fault, please troubleshoot first. Then, it must open the door of the control box, and press the reset button of the thermal relay (If it can't be pushed, please wait about 1 min. and then press it again), so that the thermal relay can resume working.

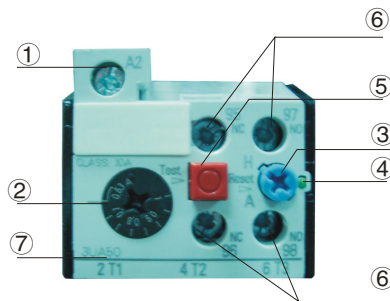

Picture 2-13: Thermal Overload Relay

The description of thermal overload relay:

- 1) Wiring terminal A2 (Used to lead out terminal A2 of the contactor coil)
- 2) Setting current adjusting scale
- 3) Reset button (blue)
H: Manual reset
A: Auto reset
- 4) Release indicator (green)
- 5) In case of manual reset, the indicator bar will be push-out after tripping, and there is no tripping indication in case of automatic reset.
- 6) Test button (red)
- 7) 95, 96, 97 and 98 are the wiring terminals of the auxiliary contacts, 95 and 96 are normally closed contacts and 97 and 98 are normally open contacts.
- 8) The terminal numbers of the main circuit must be consistent with that of the contactor.

3. Installation and Debugging



Attention !

Please read through this chapter carefully before installation, and install according to the following order!

3.1 Installation Notices

- 1) Make sure that the voltage and frequency corresponds with the requirements on manufacturer's name plate.
- 2) Connection cable and ground wire must abide by local rules and regulations.
- 3) Use independent electrical wires and power switch, and the diameter of electrical wire should not be smaller than that of the electric wire used in control box.
- 4) Wiring connections should be firmly fixed.
- 5) The power of this series of water chiller is three phase five wire, the power supply is connected to the power live wire, (N) is connected to the null wire and (G) is connected to the earth wire.
- 6) Power supply:
Main power voltage and nameplate specified voltage: $\pm 5\%$
Main power frequency and nameplate specified voltage: $\pm 2\%$
- 7) Install the pipe system according to the installation configuration diagram, and use thermal insulation materials to preserve the heat of the cold water pipe.
- 8) Select corresponding cooling tower according to the water chiller's cooling capacity.
- 9) The diameter of the circulating pump pipe shall not be smaller than that of the condenser pipe (The inlet and outlet pipe system shall be installed according to the assembly drawing). Large diameter water pipe shall be used to connect cooling water during long-distance transmission.
- 10) The water discharge valve must be installed at the lowest part of the chilled water circulation system.

- 11) When the water source quality is poor, and the ambient environment of the cooling tower is harsh, the cooling water and chilled water loop must be equipped with the filters and cleaned regularly.
- 12) The circulating circuit of chilled water shall be covered with insulation layer to avoid the loss of cooling capacity and pipeline dripping.
- 13) Since this series of machine is cooled by cooling water circulation, the user must provide enough cooling water for the water chiller according to the required water amount in the manual. Otherwise, the high-pressure pressure of the machine will be high, and the cooling capacity will decline.



The power wire connection of the water chiller must be done by the professional electrician! The circuit of the water chiller is not allowed to be modified without the consent of the company. If it is changed, our company is not liable for the machine damage.

3.2 Installation Diagram

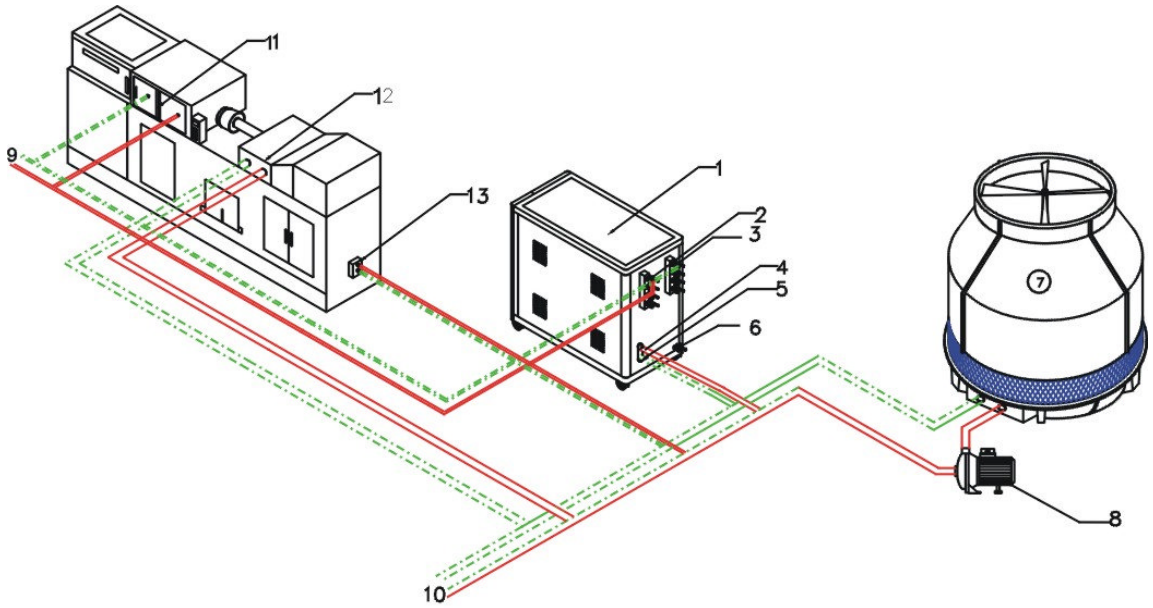

Parts Name:

- | | | |
|-------------------------|-------------------------------|--------------------|
| 1. Water chiller | 6. Drain port | 11. Mould Cooling |
| 2. Chilled water outlet | 7. Cooling water tower | 12. Cooling hopper |
| 3. Chilled water inlet | 8. Cooling water pump | 13. Oil cooling |
| 4. Cooling water outlet | 9. Chilled water circulation | |
| 5. Cooling water inlet | 10. Cooling water circulation | |

Picture 3-1: Machine Installation Location

3.3 Power Connection

The SIC-W series must be connected with the power of 3Φ 400V 50Hz and earth wire.



Attention!

Before power connection, please make sure that the main power switch is turned off!

4. Application and Operation

4.1 Panel Diagram

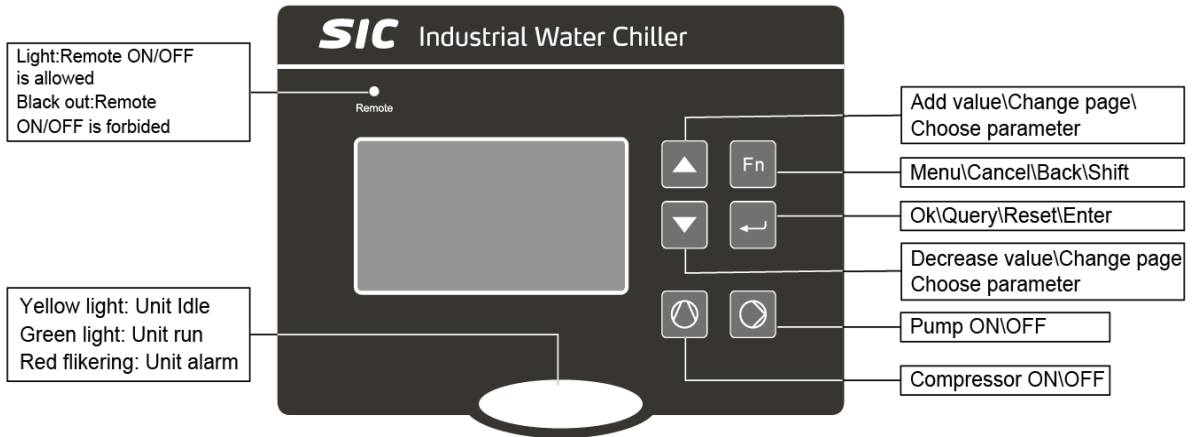

4.2 Common Screens

Commonly used screens include the main screen and the alarm screen.

1. Main Screen

The system will enter the main screen after countdown, which displays as follows:



2. Alarm Screen

In case of unit failure, the alarm screen is as follows:

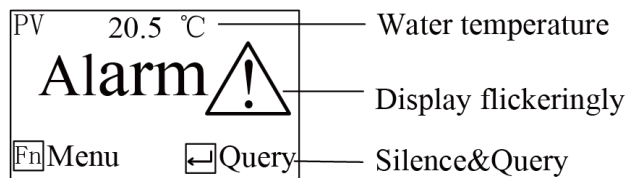

4.3 Quick Operation

1. Changing and Setting Temperature

If the user parameter [Lock Temp.] is set to "No", the setting temperature can be modified directly in the main screen, with operation details as follows:

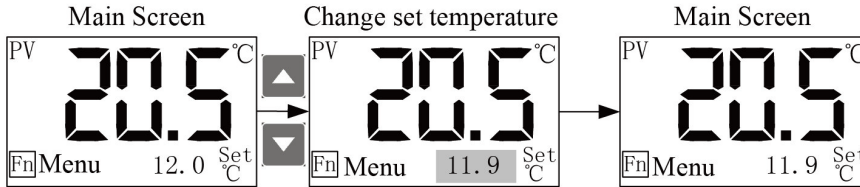

Note: the setting temperature can also be modified in the user parameters.

2. Query/Reset Fault

In case of fault, the alarm screen will automatically pop up. The operation details of query and reset faults are as follows:

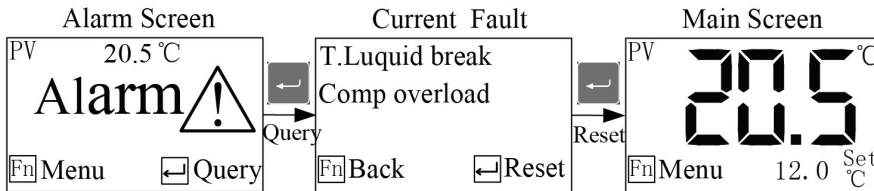

Attention!

Pump rotating direction should be correct.



Attention!

Before starting the system, make sure that cooling water pump is turned on. Check the water tank of the chiller. Do not start the machine when there is no water left in water tank. We shall not be liable for any damages caused by this reason.



Attention!



In order to reduce the possibilities of machine damage and prolong the life, start the machine with correct methods.



Attention!

The compressor can't be started frequently because of its characteristics (Frequent start will shorten its service life.). If emergency shut-down happens, the compressor will run again 3 minutes later.

4.4 Startup

- 1) Open the main power switch.
- 2) Set the temperature of chilling water (if the temp. has already been set, omit this step). The minimum temperature of this series machine should be set as 7°C.
- 3) Press  button to start the water pump.
- 4) Press  button to start the compressor.

4.5 Shutdown

- 1) Turn off the switch of compressor.
- 2) Turn off the pump switch. If it adopts the quick molding cycle and low cooling water temperature, keep continuous running of water pump till the mould temperature rises to non-condensated temperature, then turn off the pump switch.
- 3) Switch the main power switch to OFF position.



Attention!

When main power switch is at ON position, please be careful the electric shock!



Attention!

As to reduce the machine damage and prolong its service life, please turn off the machine in correct orders.

4.6 User Menu

Press the button  on the main screen to enter the User Menu, which includes five items as the table below:

No.	Menu Item	Funtion	Remark
1	User Setting	To set the user parameters	-
2	Unit Status	To display the current operating status of the unit	--
3	Fault Record	Allowing the query of the last 10 faults	Press  for 2s to clear the fault history.
4	Machine Set	To set language, backlight, time and so on.	--
5	Temp Query	To query all the temperature value	It is not display these item If measure the water temperature only.

4.6.1 Parameter Operation

For the modification operation of parameter value, the user's modification of setting temperature will be described as an example.

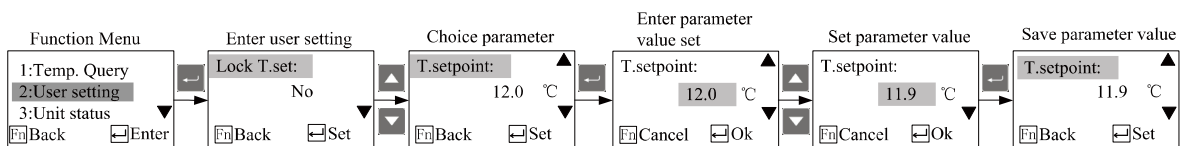

4.6.2 User Setting

All the parameters in user settings please refer to following table:

No.	Parameter Name	Factory Default	Setting Range	Remark
1	Lock Temp.	No	Yes ~ No	Yes: the [Set Temp.] can not be modified on the main screen when locked. No: the [Set Temp.] can be modified on the main screen.
2	Set Temp.	20.0°C	7.0~25°C	Setting range is limited by the manufacturer parameters [max. Temp.], [min. Temp.].
3	On/Off Mode	Local	Local / Local + Remote / Remote	Local: the unit can only start and stop locally. Local + Remote: the start and stop of the unit can be controlled both locally and remotely. Remote: the unit can only start and stop remotely.

4.6.3 Machine Set

The machine set includes six items as the table below:

No.	Item	Function	Remark
1	Language	To set the display language.	Chinese and English
2	Backlight Time	Setting range: 0~255min	0: backlight is not turned off.
3	Compr Use Time	To query the cumulative operation time of the compressor	
4	Comm. Setting	To set baud rate, parity bit, stop bit and communication address.	Communication protocol: Modbus RTU
5	Machine Info.	To query the machine version information.	
6	Clock setting	To query and set the system time.	

4.6.4 System Time Set

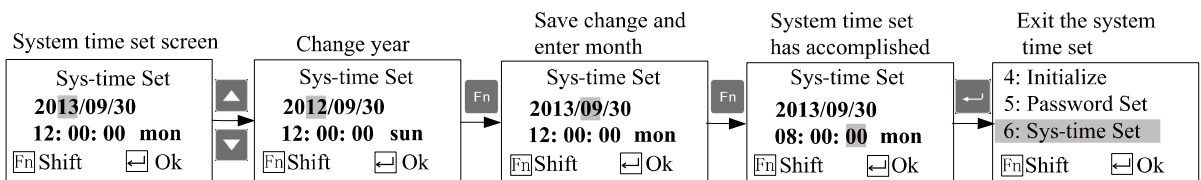

Note: Press the button  can exit the system time set quickly, and the set value will be saved when exit.

5. Trouble-shooting

Table 5-1: Single Compressor

Fault	Test Conditions	Troubleshooting	Solution
Compressor pressure High	Test when the compressor button has pressed	Stop compressor only without affect other equipments to work.	Check if the input is consistent with the switch setting.
Compressor pressure Low	If the [LP Check Delay] is 0, test when the compressor button has pressed;If the [LP Check Delay] is not 0, then compressor runs the test.		
Compressor Overload	Compressor runs the test		
Water Temp. Low	Test after pump starts	Stop the compressor, and do not stop the pump.	Check if the water temperature is lower than the set temperature of Liquid protection.
Water Temp. High		Stop the compressor, and do not stop the pump.	Check if the water temperature is higher than the set temperature of Liquid protection.
Anti-freeze Err	Power on to test	Stop the compressor, and do not stop the pump.	Check if the antifreeze input is consistent with the switch setting.
Water-temp. Sensor breaks			Check if the temperature probe is in proper contact.
Water-temp. Sensor short circuit			
Anti-freeze Sensor breaks			
Anti-freeze Sensor short circuit			
Anti-freeze Temp Low			Check if the antifreeze temperature is lower than the set temperature of antifreeze protection.
Blower fault (Only applicable for air-cooled series)	Compressor 1 runs the test	Stop the compressor, and do not stop the pump.	Check if the input is consistent with the switch setting.
Water Flow Short	Test after the pump starts for [Pump on Delay] time	Stop the unit	Check if the water flow input is consistent with the switch setting.
Pump Overload	Test after pump starts	Stop the unit	Check if the pump overload input is consistent with the switch setting.
Phase Err	Power on to test	Stop the unit	Check if there is default phase or anti-phase in the three-phase power input and if the switch is correct.
Water Level Low	Power on to test	Stop the unit	Check if the water level input is consistent with the switch setting.
Need Maintenance	Test after pump starts	The unit cannot start once stops (the accumulative operation time of compressor exceeds the set value).	Need Maintenance

Table 5-2: Double Compressor

Fault	Test Conditions	Troubleshooting	Solution
Compressor 1 pressure high	Test when the compressor button has pressed	Stop compressor 1 only without affect other equipments to work.	Check if the input is consistent with the switch setting.
Compressor 1 pressure low	If the [LP Check Delay] is 0, test when the compressor button has pressed;If the [LP Check Delay] is not 0, then compressor 1 runs the test.		
Compressor 1 overload	Compressor 1 runs the test		
Compressor 2 pressure high	Test when the compressor button has pressed	Stop compressor 2 only without affect other equipments to work.	Check if the input is consistent with the switch setting.
Compressor 2 pressure low	If the [LP Check Delay] is 0, test when the compressor button has pressed;If the [LP Check Delay] is not 0, then compressor 2 runs the test.		
Compressor 2 overload	Compressor 2 runs the test		
Water Temp. Low	Runs test	Stop the compressor, and do not stop the pump.	Check if the water temperature is lower than the set temperature of Liquid protection.
Water Temp. High		Stop the compressor, and do not stop the pump.	Check if the water temperature is higher than the set temperature of Liquid protection.
Anti-freeze Err	Power on to test	Stop the compressor, and do not stop the pump.	Check if the antifreeze input is consistent with the switch setting.
Water-temp. Sensor breaks			Check if the temperature probe is in proper contact.
Water-temp. Sensor short circuit			
Anti-freeze Sensor breaks			
Anti-freeze Sensor short circuit			
Anti-freeze temperature is too low		Stop the compressor, and do not stop the pump.	Check if the antifreeze temperature is lower than the set temperature of antifreeze protection
Blower 1 fault (Only applicable for air-cooled series)	Compressor 1 runs the test	Stop the compressor, and do not stop the pump.	Check if the blower 1 fault input is consistent with the switch setting.
Blower 2 fault (Only applicable for air-cooled series)	Compressor 2 runs the test		Check if the blower 2 fault input is consistent with the switch setting.
Water flow short	Test after the pump starts for (Pump on delay)time	Stop the unit	Check if the water flow input is consistent with the switch setting
Pump Overload	Test after pump starts	Stop the unit	Check if the pump overload input is consistent with the switch setting.
Phase Err	Power on to test	Stop the unit	Check if there is default phase or anti-phase in the three-phase power input and if the switch is correct.
Water Level Low	Power on to test	Stop the unit	Check if the water level input is consistent with the switch setting.
Need Maintenance	Test after pump starts	The unit cannot start once stops(the accumulative operation time of compressor exceeds the set value)	

Table 5-3: Triple, Quadruple Compressor

Fault	Test Conditions	Troubleshooting	Solution
Compressor 1 pressure high	Test when the compressor button has pressed	Stop compressor 1 only without affect other equipments to work.	Check if the input is consistent with the switch setting.
Compressor 1 pressure low	If the [LP Check Delay] is 0, test when the compressor button has pressed; If the [LP Check Delay] is not 0, then compressor 1 runs the test.		
Compressor 1 overload	Compressor 1 runs the test		
Compressor 2 pressure high	Test when the compressor button has pressed	Stop compressor 2 only without affect other equipments to work.	Check if the input is consistent with the switch setting.
Compressor 2 pressure low	If the [LP Check Delay] is 0, test when the compressor button has pressed; If the [LP Check Delay] is not 0, then compressor 2 runs the test.		
Compressor 2 overload	Compressor 2 runs the test		
Compressor 3 pressure high	Test when the compressor button has pressed	Stop compressor 3 only without affect other equipments to work.	Check if the input is consistent with the switch setting.
Compressor 3 pressure low	If the [LP Check Delay] is 0, test when the compressor button has pressed; If the [LP Check Delay] is not 0, then compressor 3 runs the test.		
Compressor 3 overload	Compressor 3 runs the test		
Compressor 4 pressure high	Test when the compressor button has pressed	Stop compressor 4 only without affect other equipments to work.	Check if the input is consistent with the switch setting.
Compressor 4 pressure low	If the [LP Check Delay] is 0, test when the compressor button has pressed; If the [LP Check Delay] is not 0, then compressor 4 runs the test.		
Compressor 4 overload	Compressor 4 runs the test		
Water Temp. Low	Test after pump starts	Stop the compressor, and do not stop the pump.	Check if the water temperature is lower than the set temperature of Liquid protection.
Water Temp. High		Stop the compressor, and do not stop the pump.	Check if the water temperature is higher than the set temperature of Liquid protection.
Anti-freeze Err	Power on to test	Stop the compressor, and do not stop the pump.	Check if the antifreeze input is consistent with the switch setting.
Water-temp. Sensor breaks			Check if the temperature probe is in proper contact.
Water-temp. Sensor short circuit			
Anti-freeze Sensor breaks			
Anti-freeze Sensor short circuit			
Anti-freeze temperature is too low		Stop the compressor, and do not stop the pump.	Check if the antifreeze temperature is lower than the set temperature of antifreeze protection

Fault	Test Conditions	Troubleshooting	Solution
Blower 1 fault (Only applicable for air-cooled series)	Compressor 1 runs the test	Stop the compressor, and do not stop the pump.	Check if the blower 1 fault input is consistent with the switch setting.
Blower 2 fault (Only applicable for air-cooled series)	Compressor 2 runs the test		Check if the blower 2 fault input is consistent with the switch setting.
Blower 3 fault (Only applicable for air-cooled series)	Compressor 3 runs the test		Check if the blower 3 fault input is consistent with the switch setting.
Blower 4 fault (Only applicable for air-cooled series)	Compressor 4 runs the test		Check if the blower 4 fault input is consistent with the switch setting.
Water flow short	Test after the pump starts for (Pump on delay)time	Stop the unit	Check if the water flow input is consistent with the switch setting
Pump Overload	Test after pump starts	Stop the unit	Check if the pump overload input is consistent with the switch setting.
Phase Err	Power on to test	Stop the unit	Check if there is default phase or anti-phase in the three-phase power input and if the switch is correct.
Water Level Low	Power on to test	Stop the unit	Check if the water level input is consistent with the switch setting.
Need Maintenance	Test after pump starts	The unit cannot start once stops(the accumulative operation time of compressor exceeds the set value)	

6. Repair and Maintenance

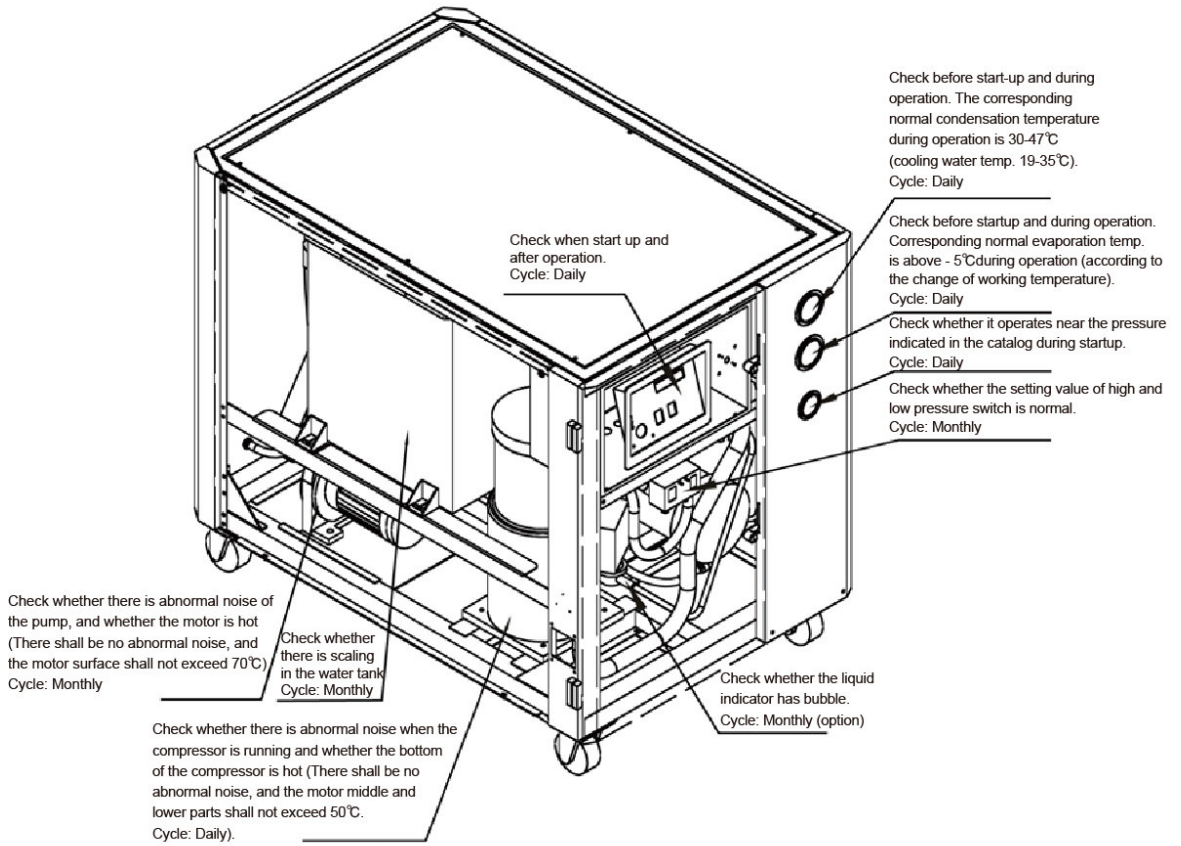

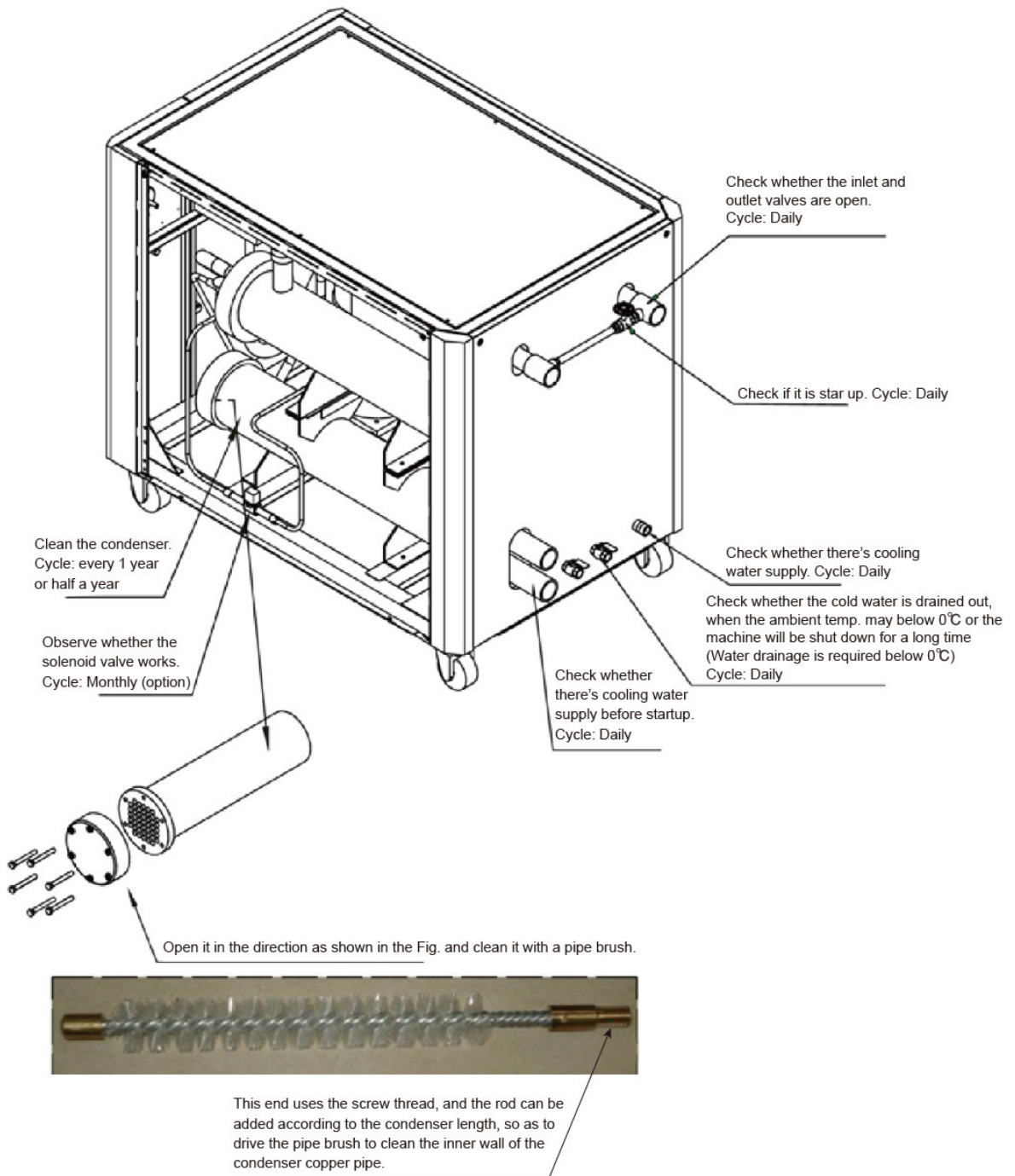



Attention!

All repair work should be done by qualified personnel only to avoid damage to the machine or personnel injury.

In order to operate the machine rightly and safely, please caution the matter follows:

- 1) Don't turn off the main power switch to stop the machine, except emergency situation.
- 2) When the machine shuts down, first press down the main power switch of the machine (the alarm light will be off); Then, check the cause of the fault again, and don't start the machine forcibly before troubleshooting.
- 3) Please check periodically to prolong the machine's service life and prevent the safety accident.
- 4) The water used in the system must have water treatment, because the high alkaline water will accelerate the corrosion of the copper pipe, and reduce the service life of the heat exchanger. The PH value of water is in the range of 7.0-8.5.
- 5) Keep the machine room dry, clean and well ventilated.
- 6) The operation and service of the machine should be done by qualified technician only (Please take notice that the disassembly and the inspection of the machines are hazardous when the machines are running!
- 7) In order to maintain the good working performance of the water chiller, the water pipes of the condenser and evaporator must be cleaned regularly, so as to avoid a large amount of water incrustation, which affects the heat exchange effect.

6.1 Filling the Refrigerant

- 1) Unscrew the cover of the liquid thimble valve, and connect the air pipe of the vacuum pump to the liquid thimble valve to vacuumize, which takes about 1 to 2 hours.

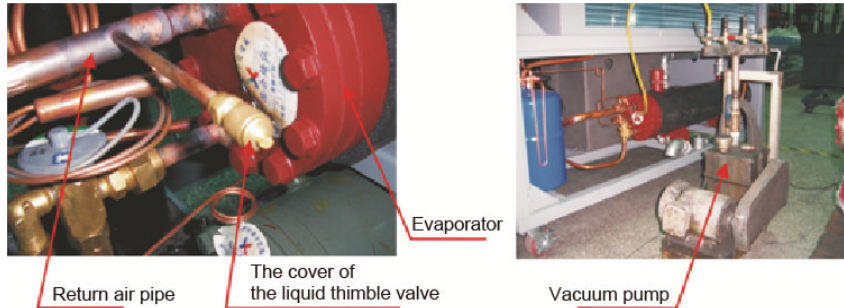

Picture 6-1: Fill in the Refrigerant (1)

- 2) After vacuumizing, connect the air pipe of the refrigerant tank to the liquid thimble valve, and add the refrigerant to the return air pipe. Monitor the weight change of the electronic scale, and stop filling the refrigerant when it reaches the rated filling weight.

When the machine is powered on, the display pressure of the high-pressure gauge is about: 13~15bar; and the display pressure of the low-pressure gauge is about: 3~5bar(Note: the ambient temperature is 30 °C, and the cooling water temperature is about 20 °C).

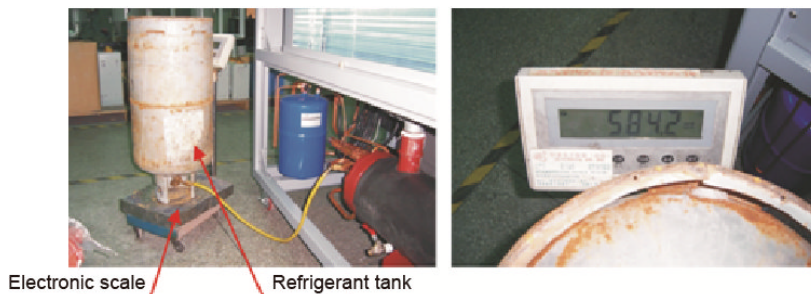

Picture 6-2: Fill in the Refrigerant (2)

Table 6-1: SIC-W Series Filling Quantity

Model	Refrigerant (kg)	Model	Refrigerant (kg)
SIC-3W	1.5	SIC-20W	10
SIC-5W	2.5	SIC-25W	14
SIC-8W	3.8	SIC-30W	17

SIC-10W	5.0	SIC-40W	20
SIC-12.5W	7.0	SIC-45W	25
SIC-15W	8.5	SIC-50W	34



Attention!

Don't replace with other refrigerant without permission.

Don't replace the components of the refrigerating system unauthorized.

The medium used is water. If you need to use other media, please consult the manufacturer in advance.

6.2 Components Maintenance

6.2.1 Condenser

The SIC-W-R2 series of water chiller adopts tube-in-shell condenser, which will have water scale on the heat transfer tubes after long-term use or there will be sundries blocked due to poor water treatment. The condenser must be cleaned regularly, so that the machine can maintain its good working performance. If the cooling water has been treated with water purification, it is recommended to use hydrogen peroxide to sterilize and remove the algae, and then check whether there is water scale after washing by the high-pressure water gun. If the cooling water is not purified, it can be cleaned with citric acid or aminoxanthic acid and corrosion inhibitor, and then washed with high-pressure water gun, which must be passivated after acid pickling, and you can purchase the passivator for the treatment.



Attention!

When machine shutdown or store unused in an environment with temperature lower than 0 °C, disconnect the pipeline, raise the front end of the machine, and force to discharge the water in the condenser.

6.2.2 Evaporator

The SIC-W series of water chiller adopts tube-in-shell evaporator, and its inner side of the heat emission pipe will pile up a great deal of water scale after long time use, which will influence the heat emission effect, so it is necessary to clean the evaporator at fixed periods in order to keep its working performance. Clean the evaporator according to the method of cleaning the condenser, and then remove the water scale from the drainage port.



Attention!

Drain the water inside the evaporator and the condenser away when the machine stop running under 0°C. If the evaporator freezes, drain the water in it before restarting.



Water Drainage Port

Picture 6-3: Water Drainage Port

6.3 Maintenance Schedule

6.3.1 About the Machine

Model _____ SN _____ Production date _____

Voltage _____ Φ _____ V Frequency _____ Hz

Total power _____ kW

6.3.2 Check after Installation

- Check the pipes are all correctly connected.
- Check if there are leakages in the piping system.
- Check if there are breaks in welding joint.

Electrical Installation

- Voltage: _____ V _____ Hz
- Fuse specification: 1 Phase _____ A 3 Phase _____ A
- Check phase sequence of power supply.

6.3.3 Daily Checking

- Check switch functions.
- Check all the electrical wires.
- Check whether pressure gauges are accurate.
- Check whether compressor temperature is normal.
- Check whether cooling water circulation is normal.

6.3.4 Weekly Checking

- Check electrical connections.
- Check protection & alarm function of the water chiller.
- Check whether set point of high-low pressure switch is normal.

6.3.5 Montly Checking

- Check the refrigerant circulation pipe.
- Check whether there are bubbles in liquid indicator.
- Check whether there is abnormal sound in pump.
- Check whether there is scale formation in tank.

6.3.6 Trimonthly Checking

- Check whether condenser is under blockage.

6.3.7 Half-yearly Checking

- Check whether the circulation pipe has leakage.
- Check and clean the condenser and evaporator.
- Check and clean the filter and expansion valve.
- Check system's performance.
- Clean condenser.

6.3.8 Yearly Checking

- Check whether the contactor is normal.

6.3.9 3 year Checking

- PC board renewal.
- No fuse breaker renewal.