

# **STM-W**

## **Water Heater**

Date: Jan. 2024

Version: Ver.H (English)



## Contents

<b>1. General Description .....</b>	<b>6</b>
1.1 Coding Principle.....	7
1.2 Feature .....	7
1.3 Options .....	8
1.4 Reference Formula of Mould Controllers Model Selection.....	9
1.5 Safety Regulations.....	9
1.5.1 Safety Signs and Labels.....	9
1.5.2 Signs and Labels.....	10
1.5.3 Operation Regulations.....	11
1.6 Exemption Clause.....	13
<b>2. Structure Characteristics and Working Principle.....</b>	<b>14</b>
2.1 Main Functions.....	14
2.1.1 Working Principle.....	14
<b>3. Installation and Debugging .....</b>	<b>15</b>
3.1 Installation Space.....	15
3.2 Pipe Connection.....	15
3.3 Power Supply.....	16
3.4 Options Installation .....	17
3.4.1 Installation steps for options water manifold (dewaxing) .....	17
3.4.2 Installation steps for options water manifold (welding) .....	18
3.4.3 Installation Steps for Function of Water Drainage via. Air Blowing	
19	
3.4.4 Installation and Operation Steps of the Optional Manual Air	
Drainer .....	20
<b>4. Operation Guide .....</b>	<b>21</b>
4.1 Machine Startup.....	21
4.2 Main Screen.....	21
4.2.1 Standby Screen.....	21
4.2.1 Operation Screen .....	23
4.3 Machine Start/Stop .....	23
4.3.1 Shutdown steps.....	23
4.4 User Setting .....	24

4.4.1	User Parameter Settings .....	24
4.4.2	Action Setting .....	25
4.4.3	Clock Timing.....	26
4.4.4	System Setting .....	27
4.4.5	Data Download.....	28
4.4.6	Advanced Setting .....	29
4.4.7	Factory Setting .....	34
4.5	Current Fault Inquiry .....	43
4.6	Inquiry Screen.....	43
4.6.1	History Fault Inquiry.....	44
4.6.2	Inquiry Screen .....	44
<b>5.</b>	<b>Trouble-shooting.....</b>	<b>47</b>
<b>6.</b>	<b>Maintenance and Repair .....</b>	<b>49</b>
6.1	Open the Covers.....	50
6.2	Y Type Strainer .....	51
6.3	Solenoid Valve .....	51
6.4	Pipe Heater.....	52
6.5	By-pass Globe Valve .....	52
6.6	Maintenance Schedule .....	53
6.6.1	About the Machine.....	53
6.6.2	Installation & Inspection.....	53
6.6.3	Daily Checking .....	53
6.6.4	Weekly Checking.....	53
6.6.5	Trimonthly Checking.....	53
6.6.6	Half-yearly Checking .....	53
6.6.7	Yearly Checking .....	53
6.6.8	3 year Checking .....	54

### Table Index

Table 3-1:	Cooling Water Inlet and Outlet Specification.....	16
Table 4-1:	Standby Screen Specifications .....	22
Table 4-2:	Operation Screen Specification .....	23
Table 4-3:	User Parameter Specification .....	25

Table 4-4: Project Parameter Description .....	30
Table 4-5: Default Parameters and Meanings .....	36
Table 4-6: Controller Exception List.....	38
Table 4-7: Current Fault Inquiry Screen Icon Key Description.....	43

## Picture Index

Picture 1-1: Water Heater STM-607W .....	6
Picture 2-1: Working Principle .....	14
Picture 3-1: Installation Space .....	15
Picture 3-2: Pipe Connection .....	16
Picture 4-1: Startup Screen.....	21
Picture 4-2: Standby Screen .....	21
Picture 4-3: Operation Screen .....	23
Picture 4-4: Main power switch .....	24
Picture 4-5: User Setting Screen .....	24
Picture 4-6: User Parameter Screen .....	25
Picture 4-7: Action Setting Screen .....	26
Picture 4-8: Clock Timing Screen.....	26
Picture 4-9: Set Timing Switch Screen.....	27
Picture 4-10: Timer Inquiry and Modification Screen .....	27
Picture 4-11: System Setting Screen .....	28
Picture 4-12: Data Download Screen.....	28
Picture 4-13: Temp. Data Download Screen .....	28
Picture 4-14: Alarm Record Download Screen.....	29
Picture 4-15: Project Screen .....	30
Picture 4-16: Project Parameter Setting Screen .....	30
Picture 4-17: Factory Setting Screen .....	34
Picture 4-18: Manufacturer Parameter Settings.....	34
Picture 4-19: Parameter Initialization Screen .....	35
Picture 4-20: Fault Clearing Screen.....	35
Picture 4-21: Manufacturer Debugging Screen .....	36
Picture 4-22: Interface Specification .....	42
Picture 4-23: Comm. Parameter Settings .....	43

Picture 4-24: Current Fault Screen .....	43
Picture 4-25: History Fault Inquiry Screen .....	44
Picture 4-26: User Setting Screen .....	44
Picture 4-27: Data Inquiry Screen .....	45
Picture 4-28: Output Inquiry Screen .....	45
Picture 4-29: Input Inquiry Screen .....	45
Picture 4-30: Version Inquiry Screen .....	46
Picture 6-1: Open the Covers 1 .....	50
Picture 6-2: Open the Covers 2 .....	50
Picture 6-3: Open the Covers 3 .....	50
Picture 6-4: Y Type Strainer .....	51
Picture 6-5: Solenoid Valve .....	51
Picture 6-6: Pipe Heater 1 .....	52
Picture 6-7: Pipe Heater 2 .....	52
Picture 6-8: By-pass Globe Valve.....	52

# 1. General Description



Read this manual carefully before operation to prevent damage of the machine or personal injuries.

The STM-W series of standard water heaters are used to heat up the mould and maintain this temperature. Besides, they can also be used in other similar applications. High temp. water from the mould is cooled by direct cooling and then sent to the pipe heater via high-pressure pump for heating to a constant temp.. With our optimised design, water can reach a maximum of 120°C. The PID temp. controller can ensure high performance and stable temp. control, and the temp. difference can be maintained at  $\pm 0.5^{\circ}\text{C}$ .



Picture 1-1: Water Heater STM-607W

## 1.1 Coding Principle

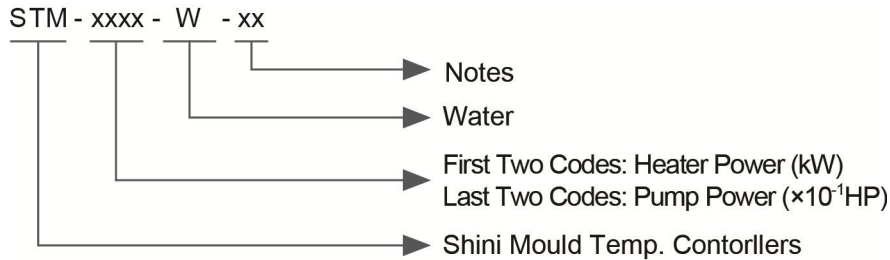

## 1.2 Feature

- 1) Controller adopts 4.3" LCD for easy operation.
- 2) SSR solid-state relay.
- 3) Standard equipped with flow display function.
- 4) In build weekly timer with  $^{\circ}\text{C}/^{\circ}\text{F}$  unit conversion.
- 5) P.I.D multi-stage temperature control system can maintain mould temperature with accuracy of  $\pm 0.5^{\circ}\text{C}$ .
- 6) Adopts high efficiency water cycle pump, which can meet the demands of temperature control for precise moulds and mould loop with minor diameter to achieve precise temperature control and high efficient heat exchange. Pump inside adopts stainless steel to avoid explosion.
- 7) Multiple safety devices including power reverse phase protection, pump overload protection, overheat protection and low level protection that can automatically detect abnormal performance and indicate this via visible alarm.
- 8) For standard STM-W, the heating temperature can reach  $120^{\circ}\text{C}$ .
- 9) Equipped with high pressure protection, safety pressure relieving, automatic water supplying and air exhausting.
- 10) Direct cooling with excellent refrigerating effect. Auto refilling device cools down the temperature to set value directly.
- 11) Modbus RTU data communication via RS485 for centralized control.
- 12) Standard buzzer
- 13) Adopt an isolated control box to extend the service life of internal appliances;
- 14) Equipped with USB interface to record real-time data and backup local data.

## 1.3 Options

- 1) Displays of mould temperature and return water temperature of mould are optional, and add "TS" at end of the model code.
- 2) For models optional with magnetic pump (excluded for STM-3650 and STM-D models), and add "M" at the end of the model code.
- 3) For models optional with auto air-blowing function, add "A" at the end of the model code. For models optional with manual air-blowing function, add "MA" at the end of the model code.
- 4) Flow switch, add "V" at the end of the model code. (Maximum operating temperature 120°C)
- 5) It could option with magnetic filter to prolong service life of magnetic pump (only suitable for models with magnetic pump), and add "MF" at the end of the model code.

All service work should be carried out by a person with technical training or corresponding professional experience. The manual contains instructions for both handling and servicing. Chapter 6, which contains service instructions intended for service engineers. Other chapters contain instructions for the daily operator.

Any modifications of the machine must be approved by SHINI in order to avoid personal injury and damage to machine. We shall not be liable for any damage caused by unauthorized change of the machine.

Our company provides excellent after-sales service. Should you have any problem during using the machine, please contact the company or the local vendor.

Shini Hotline Service:

Headquarter and Taipei factory:

Tel: + 886 (0)2 2680 9119

Shini Plastics Technologies (Dongguan), Inc.:

Tel: +86 (0)769 8331 3588

Shini Plastics Technologies (Pinghu), Inc.:

Tel: +86 (0)573 8522 5288

Shinden Precision Machinery (Chongqing), Inc.:

+86 (0)23 6431 0898



## 1.4 Reference Formula of Mould Controllers Model Selection

Heater Power (kW) = mould weight (kg) × mould specific heat (kcal/kg°C) × temperature difference between mould and environment (°C) × safety coefficient / heating duration / 860

Note: safety coefficient can select a value from 1.3 to 1.5.

Flow Rate (L/min) = heater power (kw) × 860 / [heating medium specific (kcal/kg°C) × heating medium density (kg/L) × in/outlet temperature difference (°C) × time (60)]

Note: Water specific heat =1kcal/kg°C

Heating medium oil specific heat =0.49kcal/kg°C

Water density =1kg/L

Heating medium oil density =0.842kg/L

## 1.5 Safety Regulations

Strictly abide by the following safety regulations to prevent damage of the machine or personal injuries.

### 1.5.1 Safety Signs and Labels



Danger!

The unit is designed to endure high temp, and high pressure. For safe operation, do not remove the covers or switches.



Attention!

The unit should be operated by qualified personnel only.

During operation, avoid wearing gloves or clothes that may cause danger.

Turn off main switch when power supply is off.

Stop the unit when there may be power supply problems caused by static electricity.

Put on safety gloves and shoes during installation or relocation.

Components from our company can only be used for replacement.



Warning!

- Do not touch the switch with wet object or hands.
- Do not use the machine before fully aware of its performance.
- Be careful not to touch or hit the switch or sensor.
- Please keep enough operation space, and keep away obstacles.
- To avoid producing statics, clean the floor from oil or water to keep a dry environment.
- Protect the machine against severe vibration or collision.
- Do not remove safety signs or make it dirty.
- Drunken, medicine-taking, or men without proper judgement should not operate the machine.



**Warning!**

High temperature, take care of hands! This label is attached on the surface of heating parts.

### 1.5.2 Signs and Labels

Maintenance Schedule		
		CT
Check whether pipeline joints are under looseness.		Weekly
Clean Y-type filter.		Weekly
Clean solenoid valve.		Monthly
Check the sensitivity of EGO.		Weekly
Check level switch.		Trimonthly
Check contactor.		Trimonthly
Clean process heater/cooler.		Semiyearly
Check indicator and buzzer.		Semiyearly
PCB renewal.		Every 3 year exchange
No fuse breaker.		Every 3 year exchange
Thermal oils	≤ 120°C	Renew annually
	120°C~160°C	Renew semiyearly
	> 160°C	Renew trimonthly

Note: Please refer to the Manual for detailed operations.

YP31115800700

Please according to schedule to make regular maintenance.

<p>YP30422000000</p>	<p>From mould: connector for circulating water/oil coming from mould.</p>
<p>YP30423000000</p>	<p>To mold: connector for circulating water/ oil to go to mould.</p>
<p>2~5 bar YP31091040000</p>	<ol style="list-style-type: none"> <li>1. To maintain temperature consistency, cooling water pressure must be higher than 2 bar at all time, but should never exceed 5 bar in any case.</li> <li>2. Clean Y-shape Cooling Water Strainer periodically to ensure perfect cooling capacity.</li> </ol>
<p>YP30425000000</p>	<p>Pump pressure meter: indicating actual pressure of system.</p>
<p>YP30430000000</p>	<p>Water outlet: drainage outlet.</p>
<p>YP30431000000</p>	<p>Water inlet: inlet for replenishing water and cooling water.</p>

### 1.5.3 Operation Regulations

- 1) Before operation, make sure that cooling water is clean soft water without pollutants.
  - ※ Low quality water brings limescales, which may cause problems.
- 2) If problems of drainage or bad temperature control are noted, please clean solenoid valve and cooling water inlet and outlet.
- 3) Do not move the unit when it is in operation.
- 4) When in need of repairing, wait until oil temperature falls below 30°C.

- 5) The mould temperature controller has pump overloader: When it is overloaded, the pump and pipe heater will stop. At this time, check the reasons of pump overload (phase shortage, pipe blockage, bearing damage etc.). After all is normal, reset the overload protector (RESET) or wait for the pump temp. to drop to normal temp. and resume operation.
- 6) Before turn off the pump, wait until oil temperature falls below 50°C. Or the life of the unit would be affected.
- 7) To ensure the stability of heating temp., the cooling water pressure should be 2~5kg/cm<sup>2</sup>.
- 8) If the working temp. is below 100 °C, it can set the pressure switch to 1.5~2bar; If the working temp. is set at 100 °C~120°C, it's recommended to set the value to 2.8bar; The pressure switch parameters have been set before delivery. If the cooling water pressure is too low, please adjust the pressure switch set value within the specified parameter range to achieve the effect (But it may affect the working temp. or lead to unstable temp. control), but don't change it unauthorizedly. As a result, it may result in failure, which will not be included in the warranty.
- 9) Please connect the cooling water outlet with high temperature resistant pipe when temperature is above 100°C.

## 1.6 Exemption Clause

The following statements clarify the responsibilities and regulations born by any buyer or user who purchases products and accessories from Shini (including employees and agents).

Shini is exempted from liability for any costs, fees, claims and losses caused by reasons below:

- 1) Any careless or man-made installations, operation and maintenances upon machines without referring to the Manual prior to machine using.
- 2) Any incidents beyond human reasonable controls, which include man-made vicious or deliberate damages or abnormal power, and machine faults caused by irresistible natural disasters including fire, flood, storm and earthquake.
- 3) Any operational actions that are not authorized by Shini upon machine, including adding or replacing accessories, dismantling, delivering or repairing.
- 4) Employing consumables or oil media that are not appointed by Shini.

## 2. Structure Characteristics and Working Principle

### 2.1 Main Functions

The STM-W series of standard water heater are used to heat up the mould and maintain this temperature. Besides, they can also be used in other similar applications. High temperature water from the mould is cooled by direct cooling and then sent to the pipe heater via high-pressure pump for heating to a constant temperature. With our optimised design, water can reach a maximum of 120°C and the PID temperature controller can maintain an accuracy of  $\pm 0.5^{\circ}\text{C}$ .

#### 2.1.1 Working Principle

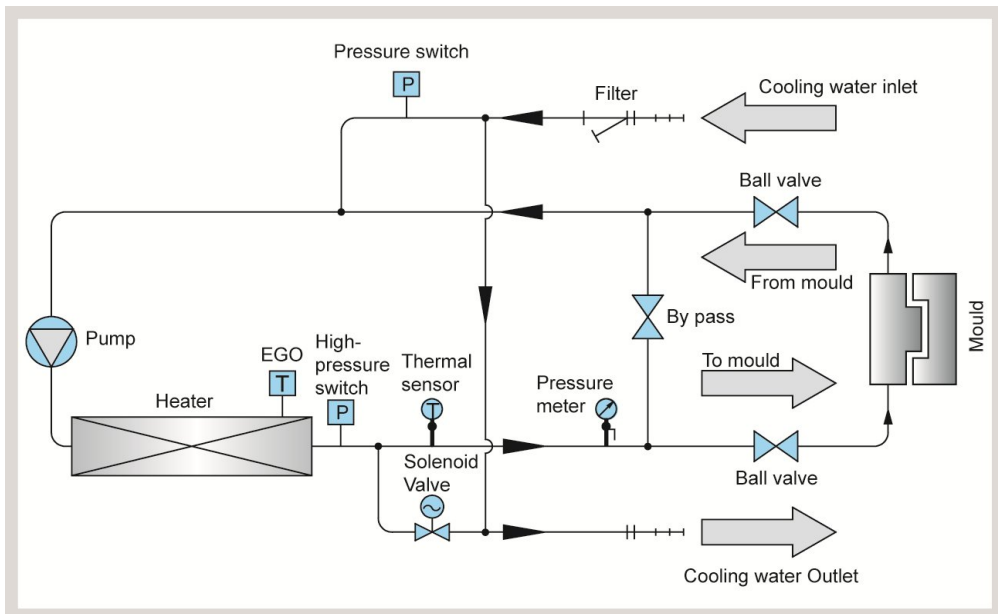

Picture 2-1: Working Principle

High temperature water returns to the machine and then be pressured by pump to the heater. After being heated, water will be forced to mould and continue the circle. In the process, if the water temperature is too high, the system will activate the solenoid valve to let cooling water cool down the temperature directly until the water is down to the system requirement. If the temperature keeps increasing and reach to the set point of EGO, system will sound high pressure alarm and stop operation; when system pressure is too high (Reach set value of high pressure switch), alarm would sounds and machine halts; when cooling water pressure fails to reach the set value, pressure switch will send a signal of water storage to launch low pressure alarm and machine halts.

### 3. Installation and Debugging

#### 3.1 Installation Space

During installation of the machine, keep at least 500mm installation space around the machine as shown by the picture. Do not install the machine in a position crowded with other objects. This would cause inconvenience to operation, maintenance and repair.

Do not sit on the machine.

Keep away flammable and explosive goods.



Picture 3-1: Installation Space

#### 3.2 Pipe Connection

- 1) The inlet and outlet specifications of the heating tank and return water pipe  
STM-607W/910W: 3/4" PT female thread  
STM-1220W/2440W/3650W:1" PT female thread
- 2) Cooling Water Connection  
Connect the cooling water inlet to the clean water source, the system inlet to the clean water source, and the cooling water outlet to the drainage port, and then turn on the water source. The cooling water flow shall not be less than 10L/Min.  
Refer to GB1576-2001 Water Quality for Industrial Boilers

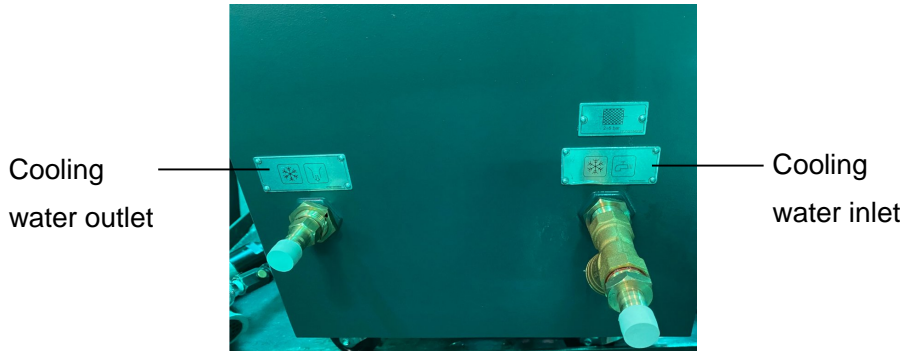

Picture 3-2: Pipe Connection

Table 3-1: Cooling Water Inlet and Outlet Specification

Model	Cooling Water Inlet	Cooling Water Outlet	Connector Type
STM-607W/910W	Φ13mm (ext. diameter )	Φ13mm (ext. diameter )	Pagoda
STM-1220W/2440W	Φ13mm (ext. diameter )	Φ13mm (ext. diameter )	Pagoda
STM-3650W	Φ13mm (ext. diameter )	Φ13mm (ext. diameter )	Pagoda

**Note: The cooling water inlet and outlet are shown in the figure below, and don't connect it reversely! When the service temp. is above 100 °C, the cooling water must be connected with high temp. resistant pipes.**

### 3.3 Power Supply

The water heater needs well electrical grounding to ensure safe running of the electrical equipments.

- 1) Make sure the voltage and frequency of the power source comply with those indicated on the manufacturer nameplate that attached to the machine.
- 2) Power cable and earth connection should conform to your local regulations.
- 3) Use independent electrical wires and power switch. Diameter of electrical wire should not be less than those used in the control box.
- 4) The power cable connection terminals should be tightened securely.



- 5) The machine requires 3-phase 4-wire power source, connect the power lead (L1, L2, L3) to the live wires, and the earth (PE) to the ground.
- 6) Power supply requirements:  
Main power voltage: +/- 5%  
Main power frequency: +/- 2%
- 7) **Please refer to electrical drawing of each model to get the detailed power supply specifications**

## 3.4 Options Installation

### 3.4.1 Installation steps for options water manifold (dewaxing)

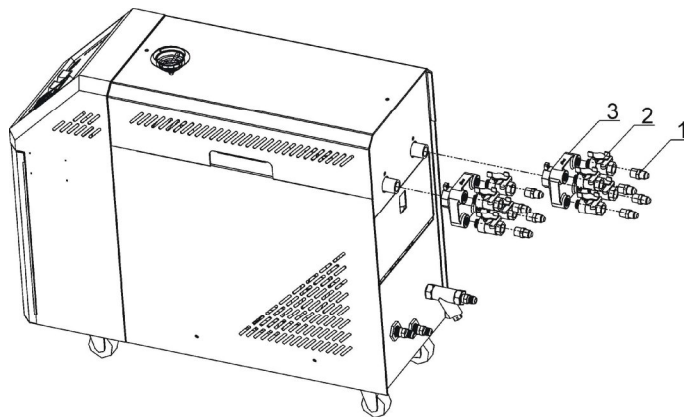

- 1) Install copper joint to the level valve.
- 2) Install level valve with copper joint to the dewaxing water manifold.
- 3) Install water manifold to the machine.
- 4) Install Teflon to copper joint.

**Note: For the operating temperature not higher than 200°C, Teflon with temperature resistance 200°C is usable; for the operating temperature from 200 to 300°C, must use Teflon with temperature resistance 300°C.**

### 3.4.2 Installation steps for options water manifold (welding)

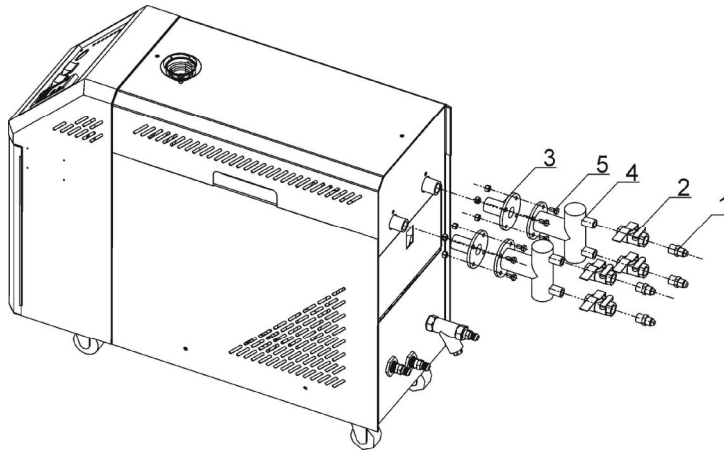

- 1) Install copper joint to the level valve.
- 2) Install level valve with copper joint to the welding water manifold.
- 3) Install water manifold to the machine.
- 4) Connect water manifold with manifold joint via screws.
- 5) Install Teflon to copper joint.

***Note: For the operating temperature not higher than 200°C, Teflon with temperature resistance 200°C is usable; for the operating temperature from 200 to 300°C, must use Teflon with temperature resistance 300°C.***

### 3.4.3 Installation Steps for Function of Water Drainage via. Air Blowing

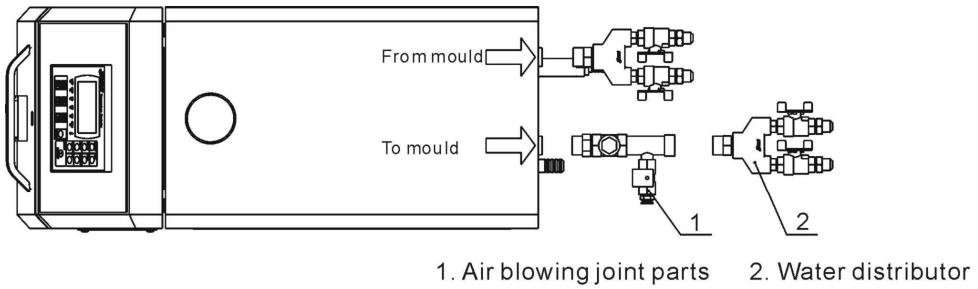

Air blowing joint parts

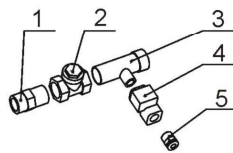

1. Pipe coupler   2. Non-return valve   3. Air blowing joint  
4. Solenoid valve   5. Quick pipe joint

- 1) Connect the air blowing joint parts to “Toward mold mouth” on mold temperature controller and then install the water distributor.
- 2) In shutdown, click the menu button on the main page, enter the user settings screen, and click on the operation buttons. Click the <reverse emptying> button on the screen, while the inlet air solenoid valve and cooling solenoid valve are opening to start water air purging function.

After draining the water for 1-2 mins. , press the < reverse emptying > button again. After drainage, close the ball valve on the water flow regulator and remove the mould.

### 3.4.4 Installation and Operation Steps of the Optional Manual Air Drainer

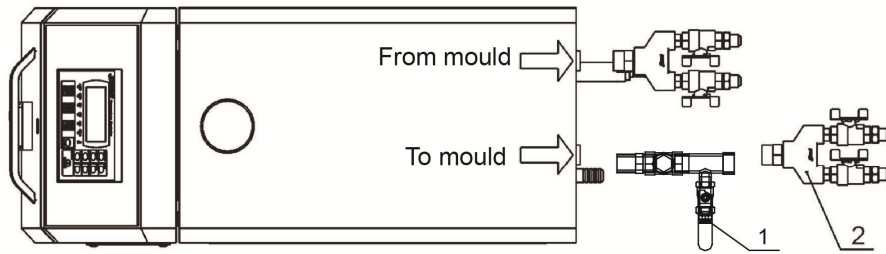

1. Air-blowing connector assemblies 2. Water flow regulator

Assembly drawing of the air-blowing connector

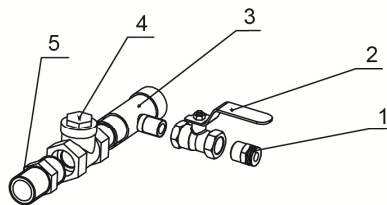

1. Air pipe quick connector 2. Ball valve 3. Air-blowing connector  
4. One-way valve 3/4'' 5. 3/4'' copper pipe coupler

- 1) Connect the assemblies of the manual air drainer connector to the mould, and then install the water flow regulator.
- 2) Open the ball valve on the manual air drainer connector when the machine is shutdown to blow and drain the water. (the ball valve is closed when the machine is started)
- 3) Close the ball valve on the manual air drainer connector after it works for 1-2 mins to drain the water. Then, close the ball valve on the water flow regulator, and remove the mould.

## 4. Operation Guide

### 4.1 Machine Startup

After the system is powered on, the panel displays the startup screen, as below:



Picture 4-1: Startup Screen



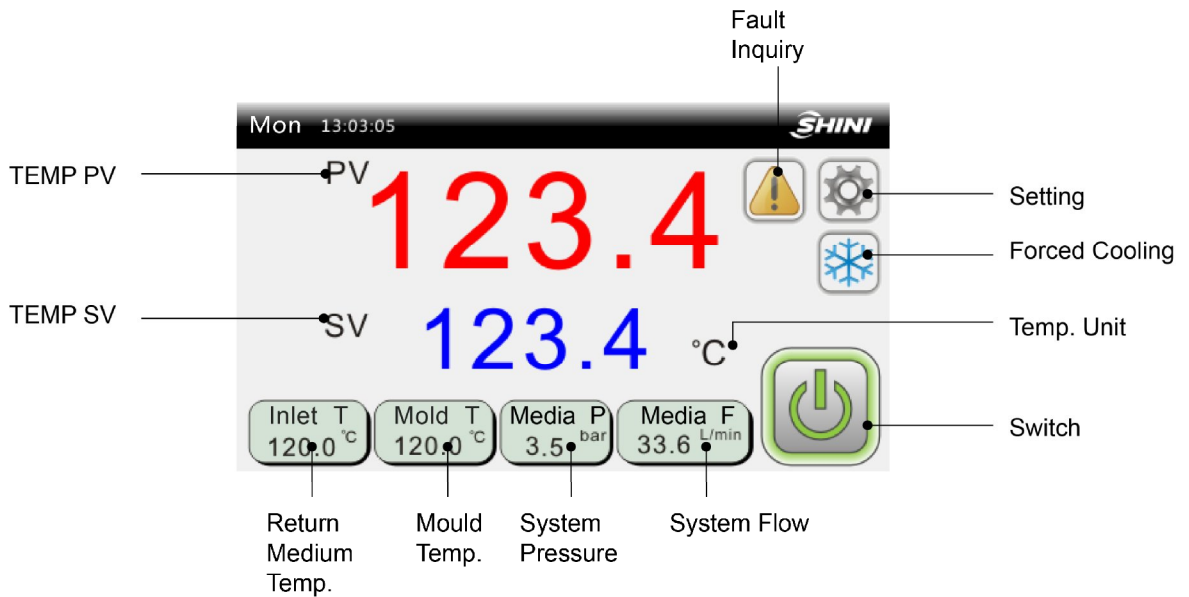

### 4.2 Main Screen

#### 4.2.1 Standby Screen



Picture 4-2: Standby Screen

Table 4-1: Standby Screen Specifications

Name	Function Type	Description
Setting	key	Enter the user setting screen
Forced cooling	button	 Start the forced cooling function  Stop the forced cooling function
Temp. unit	only display	Display the set temp. unit. The unit supports °C/ shifting.
Fault inquiry	key	<ol style="list-style-type: none"> <li>When the system fails, the main interface will flicker. At this time, click to check current fault info.;</li> <li>When no fault occurs at current, press it to inquire the "Historical Fault".</li> </ol>
Switch	key	 Standby status  Running status
Return medium temp.	only display	Display the medium temp. returned from the mould, which is optional. When not selecting this function, all displays are gray.
Mould temp.	only display	Display the mould present temp., which is optional. When not selecting this function, all displays are gray.
System pressure	only display	Display the medium output pressure, which is optional. When not selecting this function, all displays are gray.
System flow	only display	Display the medium present pressure, which is optional. When not selecting this function, all displays are gray.
Temp. SV	key	Set the heating temp.
TEMP PV	only display	Display the control temp. PV

## 4.2.1 Operation Screen

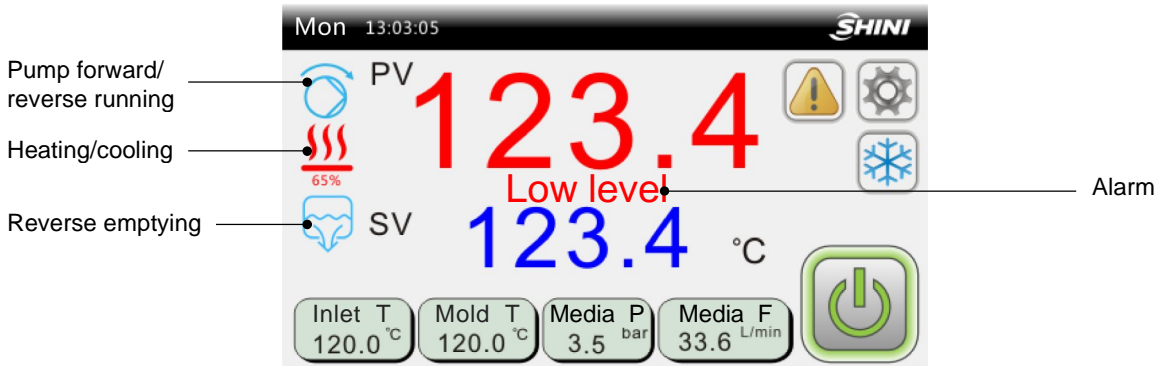

Picture 4-3: Operation Screen

Table 4-2: Operation Screen Specification

Items	Description
Pump forward / reverse running	the unit starts the pump forward / reverse running
Heating/cooling	It starts the unit temp. controlling and heating function. The bottom is heating percentage.
Reverse emptying	The unit starts emptying function
Alarm	The alarm displayer and indicator are on.

## 4.3 Machine Start/Stop

- 1) Connect the pipeline from the water heater's water outlet and inlet to the mould pipeline properly (Please refer to Chapter 3.2 for details).
- 2) Connect the cooling water inlet/refilling port (Please refer to Chapter 3.2 for details).
- 3) Open the globe ball valve of all connected pipelines.
- 4) Connect through the power, and make sure the voltage and frequency meet the standard on the nameplate.
- 5) Turn on the power switch on the door plate, and the screen will light up;
- 6) Click on the SV on the controller to set the target temp., and then click on the switch button to start the machine.

### 4.3.1 Shutdown steps

- 1) Press the<Forced cooling>button to turn off the heating output and turn on 100% cooling.

- 2) When the temperature drops below 50 °C , press the <Forced cooling> button to turn off the forced cooling, and then press the <Run/Stop> button to stop the machine.
- 3) Turn the main power switch to OFF.

**Note: When the main power switch is ON, please be aware of the risk of electric shock!**

**Attention: The pump direction must be correct!**

**Attention: To reduce machine damage and extend its lifespan, please turn on and off the machine according to correct steps!**

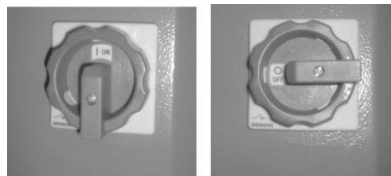

ON

OFF

Picture 4-4: Main power switch

## 4.4 User Setting

In the "Operation" screen, click the < Setting > button to enter the "User Setting" screen:



Picture 4-5: User Setting Screen

### 4.4.1 User Parameter Settings

In the "User Setting" screen, click the < User Parameters > button to set user parameters:



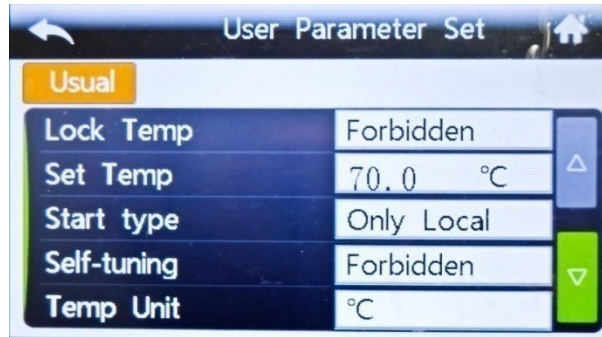

Picture 4-6: User Parameter Screen

Table 4-3: User Parameter Specification

Parameter	Initial Value	Setting Range	Unit	Remarks
Locking temp.	disable	disable- use		When selecting the "use", it's not allowed to set temperature on the main interface.
Setting temp.	80.0	0-120.0	°C	
Start/stop mode	local	local~local+ remote ~ remote		Local: unit startup/shutdown can only be controlled locally. Local + remote: unit startup/shutdown can only be controlled locally and remotely. Remote: unit startup/shutdown can only be controlled remotely.
Auto turning	disable	disable- enable		
Temp. Unit	°C	°C/°F		Temp. display unit
Decimal point	0.1	1/0.1		The main screen has mini. temp. unit display

#### 4.4.2 Action Setting

In the "User Setting" screen, click the < Action Setting > button to enter the screen below:



Picture 4-7: Action Setting Screen

#### 4.4.2.1 Reverse Emptying

After the machine stops, it will start pump reverse running and exhaust valve, which can be started and stopped manually or automatically (The factory default of reversal running time is 60S, and refer to the project parameter table for specific settings).

***Note: If the reverse emptying function is on during machine running, stop the machine first, and then activate the reverse emptying action.***

#### 4.4.3 Clock Timing

Click the < Clock Timing > button in the user setting screen to enter the following screen:

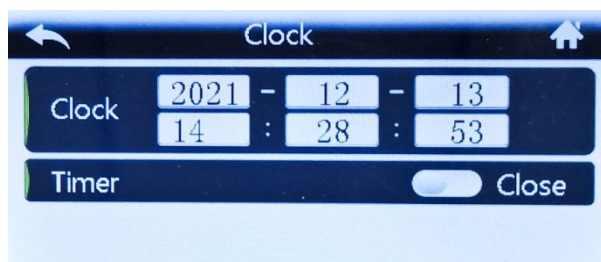

Picture 4-8: Clock Timing Screen

Timing main switch: used to select the timing on/off function, and it can inquire on the main screen if the timing is switched on. It can set six groups of time in total, and each group of time can be selected through the switch: disable, timing on or off.

After timing main switch is turned on, it can set the timing on/off, as shown in the

picture below:

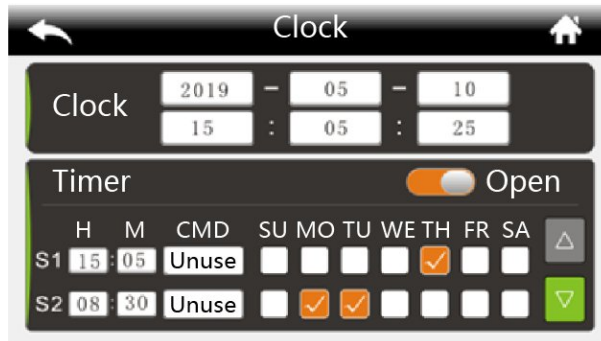

Picture 4-9: Set Timing Switch Screen

If the "Timing Main Switch" is set to "ON", press the < Clock > button in the "Operation" screen to enter the Timing Inquiry and Modification Screen.

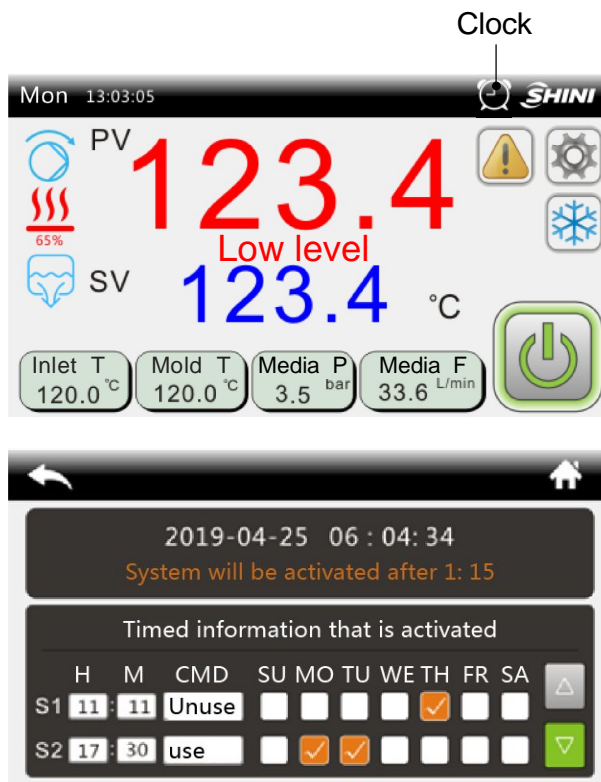

Picture 4-10: Timer Inquiry and Modification Screen

#### 4.4.4 System Setting

In the "User Setting" screen, click the < System Setting > button to enter the picture below:

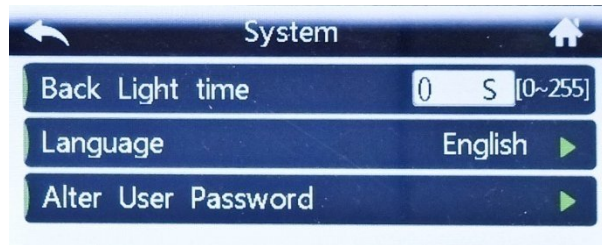

Picture 4-11: System Setting Screen

Set the backlight time: setting range is 0 ~ 255 secs.

Language: Chinese or English

The default user password is 123. See "Password Modification" for details;

#### 4.4.5 Data Download

When downloading data, please use the U disk format: FAT32, and the recommended U disk capacity is 16g or below.

In the user setting screen, click the < Data Download > button to enter the following screen:

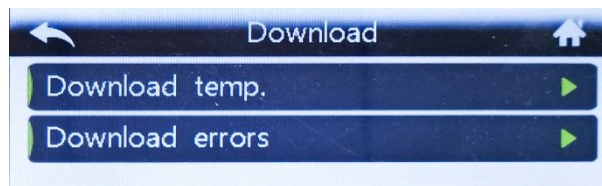

Picture 4-12: Data Download Screen

##### 4.4.5.1 Temp. Data Download

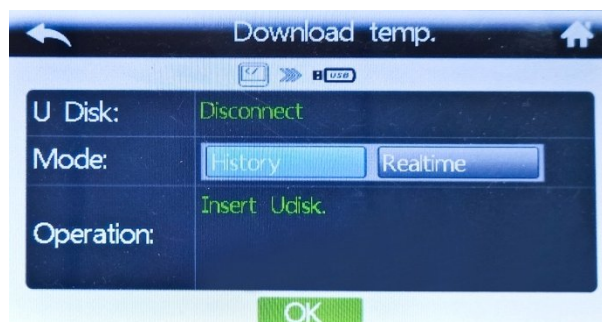

Picture 4-13: Temp. Data Download Screen

Local data backup: copy the temp. data on the display board to the U disk (the data of display board can be saved for up to 48 hrs.). Copy the temperature data stored on the display board to the USB flash disk. Insert the U disk, wait until the

"U disk" displays "connected" status, and then follow the prompts. Other operations are prohibited during the download process.

Real-time data recording: After inserting the U disk and starting the real-time data recording function, then the temp. data will be updated in real time and stored in the U disk automatically, and the recording will be interrupted after unplugging the U disk. Operations on other screens are available during recording.

 **Attention!**

***After data export, a folder/SF51XXX will be created in the U disk root directory, and the data will be saved in Excel.***

#### 4.4.5.2 Alarm Record Download



Picture 4-14: Alarm Record Download Screen

#### 4.4.6 Advanced Setting

##### 4.4.6.1 Project Setting

In the "User Settings" screen, click the < Advanced Setting > button and enter the password to enter the "Project" screen.



Picture 4-15: Project Screen

In the "Project" screen, click the < Project Parameter > button to enter the project parameter setting

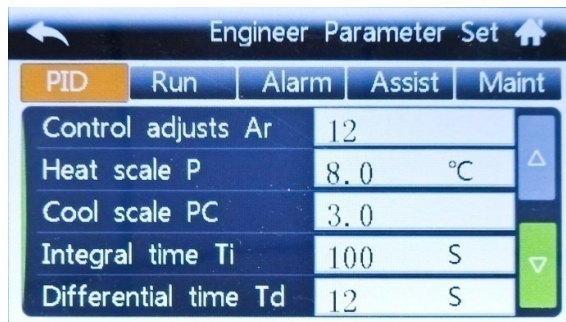

Picture 4-16: Project Parameter Setting Screen

Table 4-4: Project Parameter Description

PID	Control response adjustment Ar	12.0	1~30		Adjust PID control response
	Heating proportional band P	8.0	0.1~200.0℃	℃	
		46.4	32.2-392.0		
	Cooling proportional band PC	3.0	0.1~20.0		Multiples of heating proportional band
	Integral time Ti	100.0	1~3600	sec.	
	Differential time Td	12.0	0~3600	sec.	
	Heating cycle T	15.0	1~300	sec.	
	Cooling cycle TC	15.0	1~300	sec.	
overlap zone db	0.0	-30.0~30.0	℃		
	0.0	-54.0~54.1	°F		
Runni ng	Probe spe.	K Type	K Type thermocouple /PT100	/	

	The number of probes	control circuit	Control loop~control+return medium~control+mould~control+return medium + mould	/	Control circuit: Control temp. probe only Control + return medium: control temp. + return medium temp. Control + mould: control temp. + mould temp. Control+mould+mould: control temp. + return medium temp. + mould temp.
	Shutdown temp.	35.0	0~60.0	°C	Shutdown temp.: stop the machine when it cools down to this temp.
		95.0	32.0-140.0	°F	
	Emptying time	0 sec.	0-600 sec.	sec.	Reverse emptying action: After shutdown, start the pump reverse running and the emptying valve. It can start and stop manually, or run the [reversal time] and stop automatically.  Note: If the reverse emptying function is activated during machine running, stop the machine first and then perform the reverse emptying action.
Fault	3-phase power detection	Use	disable / use	/	Whether it uses the on-board 3-phase power detection;
	Return medium deviation alarm	0.0	0-50.0	°C	(1)  Return medium temp. – medium output temp.  > 【return medium temp. deviation】 , delay 【temp. deviation alarm delay】 secs., it alarms “Large return medium temp. difference”, make auto reset. 0: disable  (2) After modifying [SV] or forced cooling, this fault will not be solved in previous temp. rises / drops.
		0.0	0-90.0	°F	
Fault	Different mould	0.0	0-50.0	°C	(1)  Return medium temp. –



temp. alarm	0.0	0-90.0	°F	<p>medium output temp. <math>&gt;</math> <b>【return medium temp. deviation】</b> , delay <b>【temp. deviation alarm delay】</b> secs., it alarms “Large return medium temp. difference”, make auto reset. 0: disable</p> <p>(2) After modifying [SV] or forced cooling, this fault will not be solved in previous temp. rises / drops.</p>
Different temp. alarm delay	5	0-360	sec.	
Low temp. deviation alarm	0.0	0-50.0	°C	<p><b>【SV】 - PV <math>&gt;</math> 【Low temp. deviation alarm】</b> delay two secs., it alarms low temp., <b>【SV】 - PV <math>&lt;</math> 【low temp. deviation alarm】</b> , it will reset the fault automatically.</p> <p>When <b>【Low temp. deviation alarm】</b> =0 , this function is disabled.</p>
	0.0	0-90.0	°F	
High temp. deviation alarm	0.0	0-50.0	°C	<p>PV - <b>【SV】</b> <math>&gt;</math> <b>【High temp. deviation alarm】</b> delay two secs., it alarms high temp., , PV - <b>【SV】</b> <math>&lt;</math> <b>【High temp. deviation alarm】</b> , it will reset the fault automatically.</p> <p>When <b>【High temp. deviation alarm】</b> =0 , this function is disabled.</p>
	0.0	0-90.0	°F	
Low flow alarm	0.0	0-100	L/min	<p>Use flow sensor, the medium flow is lower than the [Low flow alarm], it delays two secs., and alarms “Low flow”;</p> <p>0: disable</p>
High pressure alarm	0.0	0-50	bar	<p>Use pressure sensor, the medium pressure is high than the [High pressure alarm], it delays two secs., and alarms “High pressure”;</p> <p>0: disable</p>



Fault	Heater alarm	0.0	0~999	分	<p>1. If the machine fails to reach the set temp. of - 5 °C within the [heater alarm] time, it will give the "heater alarm", and continue to control the temp. Manual reset.</p> <p>2. Set to 0, disable the limit detection.</p>
	Over temp. trip temp. difference	15.0	0~100	°C	PV - 【SV】 > 【overheat trip output temp. difference】 , open the circuit breaker, the EGO will alarm;
		9.0	0-180	°F	
	Interference alarm	0.0	0~200.0	°C/ sec.	<p>1. Monitor temp. variation trend</p> <p>2. The temp. rises or drops exceeds the 【 Interference alarm temp. 】per second, it will give "Interference Alarm", and reset the fault automatically.</p> <p>3. Set to 0: disable.</p>
0.0		0-360.0	°F/ sec.		
Assist	Control temp. compensation	0.0	-30.0~30.0	°C	Compensate the measurement error of the medium output temp.
		0.0	-54.0~54.0	°F	
	Return medium temp. compensation	0.0	-30.0~30.0	°C	Compensate the measurement error of the return medium temp.
		0.0	-54.0~54.0	°F	
	Return medium temp. compensation	0.0	-30.0~30.0	°C	Compensate the measurement error of the return medium temp.
		0.0	-54.0~54.0	°F	
	Mould medium temp. compensation	0.0	30.0~30.0	°C	Compensate the measurement error of the mould temp.
		0.0	-54.0~54.0	°F	
Analog quantity AI1 compensation	0.0	-30.0~30.1	bar	Compensate the pressure measurement error	
Analog quantity AI2 compensation	0.0	-30.0~30.2	L/min	Compensation flow measurement error.	
Assist	Comm. address	0	0-31		Communication basic info. setting
	Baud rate	19200.0	4800、9600、19200		
	Check bit	No parity	No parity, even parity check, odd parity		
	Stop bit	1bit	1 bit, 2 stop bits		

	Comm. address set	SHINI	SHINI, GBT		
Maintenance	Unit maintenance time	0.0	0-3000	hr.	When the set accumulative running time is greater than [unit maintenance time], it alarms" Unit Maintenance Fault";
	Accumulative total running time (hr.)	0.0	0-3000	hr.	
	Accumulative total running time (min.)	0.0	0-59	Min.	

#### 4.4.7 Factory Setting

In the "Project" screen, click < Factory Setting >, and enter the password to enter the "Factory Setting" screen.



Picture 4-17: Factory Setting Screen

##### 4.4.7.1 Manufacturer Parameter Settings

Set manufacturer parameters. For detailed instructions on each parameter, please refer to the Manufacturer Parameter Table.

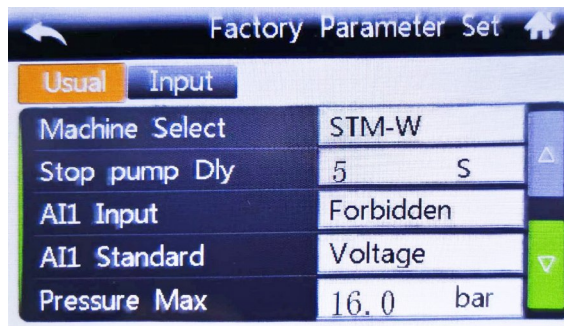

Picture 4-18: Manufacturer Parameter Settings

##### 4.4.7.2 Parameter Initialization

User parameters, project parameters and manufacturer parameters can be initialized without initializing passwords.

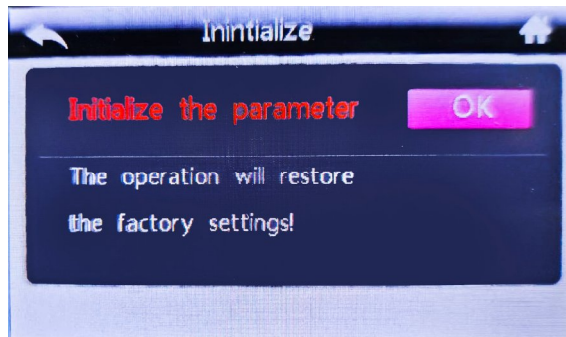

Picture 4-19: Parameter Initialization Screen

#### 4.4.7.3 Fault Clearing

Clear all historical faults.

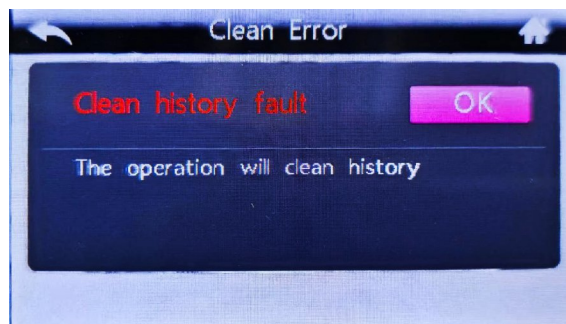



Picture 4-20: Fault Clearing Screen



#### 4.4.7.4 Manufacturer Debugging

User can enter this operation under non-operational status, and debug relay output.



Picture 4-21: Manufacturer Debugging Screen

When the button  is grey, press  to start relay output.

When the button  is green, press  to close the relay.

#### 4.4.7.5 Default Parameter Table

Table 4-5: Default Parameters and Meanings

	Parameter Name	Initial Value	Setting Range	Unit	Remarks
Equipment	Model selection	common water W	common water ~ flow rate water WF~ common oil O	common water W	After switching models, please power on again.
	Pump stop delay	5s	3-60s	secs.	The reverse or forward rotation can only be started after the pump stop delay [pump stop delay]: no high-temp. water
	AI1 input definition	Disabled	Disabled/ media pressure	/	
	AI1 input specification	Current	Current, voltage		Manually adjust the SW3 thin code switch on the control board, and select the correct analog signal input.
	Upper limit of pressure measurement	16.0	0.0~99.9	bar	
	Lower limit of pressure measurement	0.0	0.0~99.9	bar	
	AI2 input definition	Disabled	Disabled / Media flow rate		

	AI2 input specification	Current	Current, voltage		Manually adjust the SW2 thin code switch on the control board, and select the correct analog signal input.
	Upper limit of flow measurement	200.0	0~999.9	L/min	
	Lower limit of flow measurement	0.0	0~999.9	L/min	
	Set temp. upper limit	90.0	0~200.0	℃	Common water W: 0-120 Water flow WF: 0-120 Common oil O: 0-200 High temp. oil HT : 0-300 Oil flow F: 0-200
		194.0	32.0-392.0	°F	
	Set temp. lower limit	0.0	0~200.0	℃	Whether to start power failure recovery function
		32.0	32.0-392.0	°F	
	Power failure recovery function	Disabled	Disabled / enabled		
	AI1 voltage input upper limit	4.5	0.2-10.0	V	【AI1 input spe.】 selects “voltage” display
	AI1 voltage input lower limit	0.5	0.2-10.0	V	【AI1 input spe.】 selects “voltage” display
	AI2 voltage input upper limit	4.5	0.2-10.0	V	【AI2 input spe.】 selects “voltage” display
	AI2 voltage input lower limit	0.5	0.2-10.0	V	【AI2 input spe.】 selects “voltage” display
	AI1 current input upper limit	20.0	2.0-20.0	mA	【AI1 input spe.】 selects “current” display
	AI1 current input lower limit	4.0	2.0-20.0	mA	【AI1 input spe.】 selects “current” display
	AI2 current input upper limit	20.0	2.0-20.0	mA	【AI12 input spe.】 selects “current” display
	AI2 current input lower limit	4.0	2.0-20.0	mA	【AI12 input spe.】 selects “current” display

Input	Pump overload	normal open	normal open ~ normal close
	EGO overheat	normal open	normal open ~ normal close
	Low pressure	normal open	normal open ~ normal close
	High pressure	normal open	normal open ~ normal close
	Low liquid level	normal open	normal open ~ normal close

	High liquid level	normal open	normal open ~ normal close
--	-------------------	-------------	----------------------------

**Table 4-6: Controller Exception List**

No.	Fault Name	Detection Logic	Reset Mode
0	Pump overload	1. Power-on detection 2. Pump overload input point is valid, and the alarm delays 2 secs. Stop and release.	Manual reset
1	EGO overheat	1. Power-on detection 2. Alarm action: EGO input point alarms delay 2 secs. effectively, and it opens the circuit breaker output point	Manual reset
2	Low pressure at the water inlet	1. After system powered on, it starts to detect the inlet water pressure. 2. Low pressure input point is valid, and the alarm delays 2 secs.	Manual reset
3	High pressure	Switching detection: 1. Power-on detection 2. High pressure input point is effective, and the alarm delays two secs. and shuts down.	Manual reset
4	3-phase power phase reverse / phase loss	1. When alarm occurs, the machine stops running. After troubleshooting, reset manually. 2. When powered on, it starts detection, the phase reverse alarm delays 1.2 secs., and the phase shortage alarm delays 3 secs. If it needs to disable the on-board phase sequence detection, please set the project parameter [3-phase power detection] to "disabled".	Manual reset
5	Abnormal control probe	1. Power-on detection. When it alarms, the machine stops running.	Manual reset
6	Abnormal return medium probe	1. Power-on detection. When it alarms, the machine stops running.	Manual reset
7	Abnormal mould probe	1. Power-on detection. When it alarms, the machine stops running.	Manual reset
8	Pressure sensor fault	1. Check whether the sensor input signal is normal. When it alarms, the machine runs continuously.	Manual reset

		2. AI 1 input is defined as "disabled", disable the fault.	
9	Flow sensor fault	1. Check whether the sensor input signal is normal. When it alarms, the machine runs continuously. 2. AI2 input is defined as "disabled", disable the fault.	Manual reset
10	Large temp. difference of return medium	1. When it alarms, the machine runs normally. After troubleshooting, reset manually. 2. Detecting during unit's operation: (1)   Control temp. – return medium temp.   > 【Return medium temp. deviation】 , it delays 【Temp. difference alarm delay】 secs., and it alarms large return medium temp. difference. When the 【Output and return medium temp. difference】 = 0, disable this function. (2) It processes only the temp. exceeds the set value and after a temp. variation cycle. After modifying the [SV], it doesn't process this fault.	Auto reset
11	Interference Alarm	1. When it alarms, the machine runs normally. After the fault is dismissed, it will reset automatically. 2. In the temp. control stage, the temp. drops or rises beyond the [Interference alarm] temp. within 1s. When the 【Interference alarm】 = 0, disable this fault.	Auto reset
12	Heater alarm	1. When it alarms, the machine runs normally. 2. In the temp. control stage, when the control temp. can't reach the set temp. of -5 °C within the【Heater alarm】time, it alarms. When it reaches the set temp., it will dismiss the alarm automatically. When the 【Heater alarm】 = 0, disable this fault.	Auto reset
16	Too high temp.	1. When it alarms, the machine runs normally. 2. PV – 【SV】 > 【High temp. deviation alarm】 , it delays 2 secs., and gives high temp. alarm. PV – 【SV】 < 【High temp. deviation alarm】 , it resets the fault automatically. When the 【High temp. deviation alarm】 = 0, disable this function.	Auto reset

		Note: In order to prevent false alarm after modifying the set temp., the fault can only be solved after the PV temp. reaches the set temp. once.	
13	Too low temp.	<p>1. When it alarms, the machine runs normally.</p> <p>2. <b>【SV】 - PV &gt; 【Low temp. deviation alarm】</b> , it delays 2 secs., and gives low temp. alarm.</p> <p><b>【SV】 - PV &gt; 【Low temp. deviation alarm】</b> , it resets the fault automatically.</p> <p>When the <b>【Low temp. deviation alarm】 = 0</b>, disable this function.</p> <p>Note: In order to prevent false alarm after modifying the set temp., the fault can only be solved after the PV temp. reaches the set temp. once.</p>	Auto reset
14	Rear plate data error	Parameter data verification error. Please contact the manufacturer in case of this fault,	Manual reset
15	Unit needs maintenance	Power on detection: Once this fault occurs, the unit can't start. Enter the project parameter to set the [Unit maintenance time] to 0, and eliminate this fault.	Manual reset
16	Overheat alarm	<p>1. When it alarms, the machine runs automatically, and the circuit breaker opens.</p> <p>2. <math>PV - \text{【SV】} &gt; \text{【Overheat release output temp.】}</math>, the circuit breaker opens, and it gives overheat alarm.</p> <p>When the <b>【Overheat release output temp.】 = 0</b>, disable this function.</p> <p>Note: In order to prevent false alarm after modifying the set temp., the fault can only be solved after the PV temp. reaches the set temp. once.</p>	Manual reset
17	Too large mould temp. difference	<p>1. When it alarms, the machine runs normally. After troubleshooting, reset manually.</p> <p>2. Detecting during unit's operation:</p>	Auto reset



		<p>(1)   Control temp. – mould temp.   &gt; 【 Mould temp. deviation 】 , it delays 【 Temp. difference alarm delay 】 secs., and it alarms large return medium temp. difference. When the 【 Mould temp. deviation 】 = 0, disable this function.</p> <p>(2) It processes only the temp. exceeds the set value and after a temp. variation cycle. After modifying the [SV], it doesn't process this fault.</p>	
18	Too low flow	<p>1. Machine shutdown when it alarms. After the flow becomes normal, reset manually.</p> <p>2. Use flow sensor. When it running, the medium flow is lower than the 【 Low flow alarm 】 , it delays 2 secs. and alarms "low flow".</p> <p>When the 【 Low flow alarm 】 = 0, disable this fault.</p>	Manual reset
19	3-phase power phase reverse / phase loss	<p>1. When alarm occurs, the machine stops running. After troubleshooting, reset manually.</p> <p>2. When powered on, it starts detection, the phase reverse alarm delays 1.2m secs., and the phase shortage alarm delays 3 secs. If it needs to disable the on-board phase sequence detection, please set the project parameter [3-phase power detection] to "disabled".</p>	Manual reset
20	Overtime when communicating with the rear plate	The comm. wire between the display panel and the control board breaks	Auto reset

#### 4.4.7.6 Shini Communication Method

##### 1) Interface specification and communication definition:

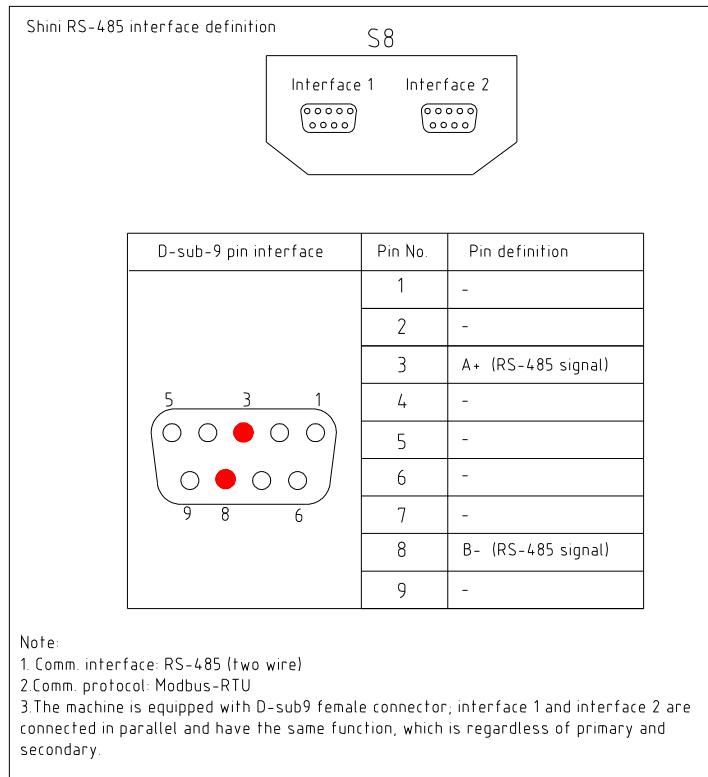

Picture 4-22: Interface Specification

Comm. Protocol:

Communication parameters can be set in "Engineering Settings" - Engineering Parameters - "Auxiliary".

Built- in Modbus- Rtu protocol.

**Note:**

**The communication address, Baud, check bit and stop bit are adjusted according to the actual demands.**

##### 2) Comm. address set selection:

SHIINI(default):The address definition of Shini controller (as shown in the Appendix).

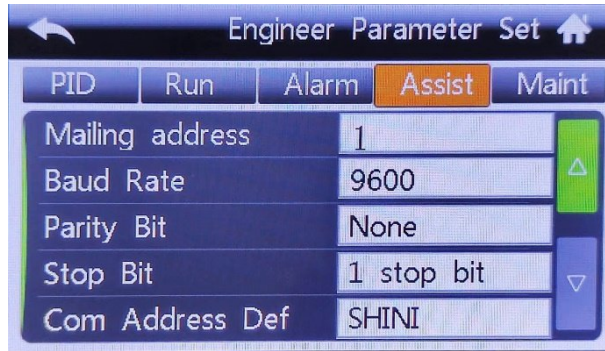

Picture 4-23: Comm. Parameter Settings

## 4.5 Current Fault Inquiry

When the unit fails, in the “Operation” screen, the < Fault Inquiry > button will flicker. At this time, click the < Fault Inquiry > button to silence and enter following screen:

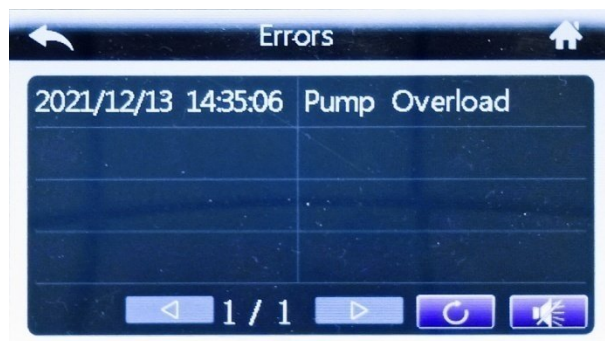

Picture 4-24: Current Fault Screen

Table 4-7: Current Fault Inquiry Screen Icon Key Description

Press Key	Key Name	Description
	Fault reset	After trouble-shooting, press this key to reset the fault.
	Silence	Eliminate the system alarm sound
	Page up	Turn the page to query the fault information, gray key can't be pressed, and green key can be pressed.
	Page down	Turn the page to query the fault information, gray key can't be pressed, and green key can be pressed.

## 4.6 Inquiry Screen

#### 4.6.1 History Fault Inquiry

When there is no fault currently, click the < Fault Inquiry > button in the "Operation" screen to enter the history fault inquiry.

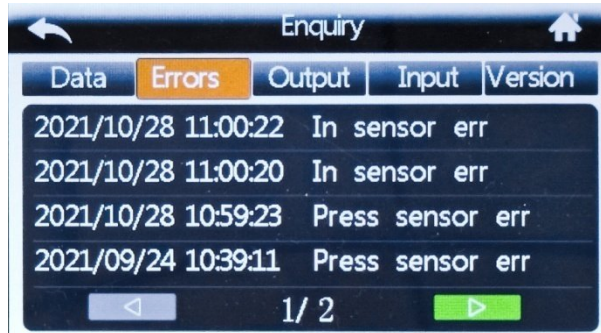

Picture 4-25: History Fault Inquiry Screen

#### 4.6.2 Inquiry Screen

In the "Operation" screen, click the < Setting > button to enter the "User Setting" screen, and click the < Inquiry > button to enter the inquiry screen.

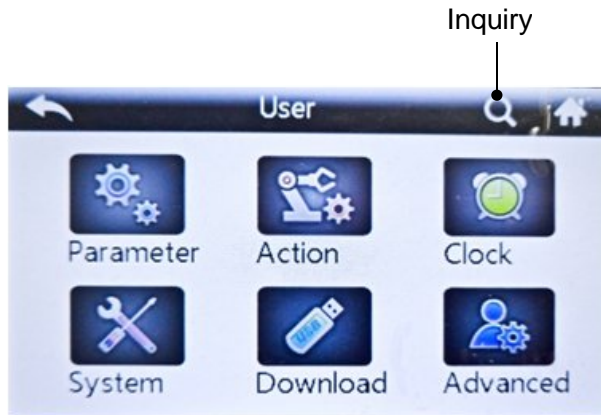

Picture 4-26: User Setting Screen

##### 4.6.2.1 Data Inquiry

It can check all probes' temperature, pressure of current system, and query the system running time and other data:



Picture 4-27: Data Inquiry Screen

#### 4.6.2.2 Output Inquiry

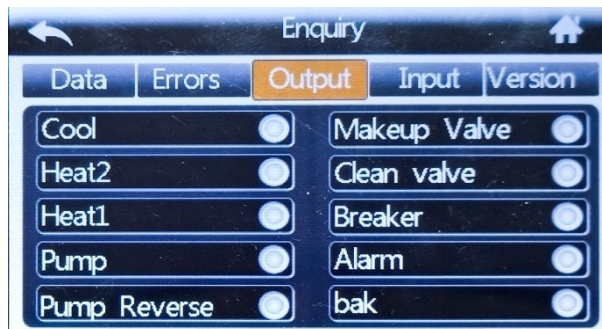

Picture 4-28: Output Inquiry Screen

When the indicator is gray, it means that corresponding relay has no output.

When the indicator light is green, it indicates that corresponding relay is outputting.

#### 4.6.2.3 Input Inquiry

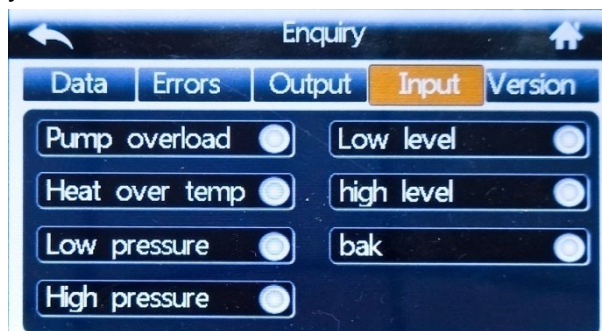

Picture 4-29: Input Inquiry Screen

When the indicator light is gray, it indicates that corresponding switch input is invalid.

When the indicator light is green, it indicates that corresponding switch input is valid.

#### 4.6.2.4 Version Inquiry

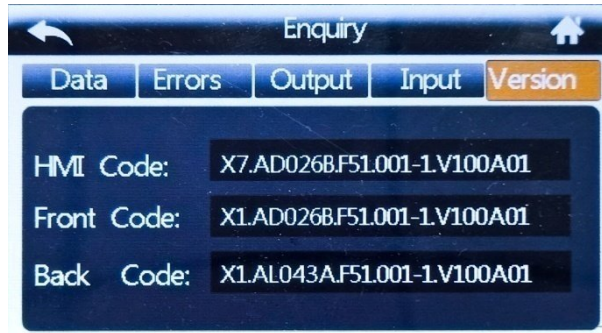

Picture 4-30: Version Inquiry Screen

Take real display value as standard.

## 5. Trouble-shooting

Failures	Possible reasons	Solutions
LCD displays nothing after switch on power and press ON/OFF key.	Did not connect through power supply. Main switch broken. Power supply wires problems. Control circuit fuse melt. Transformer broken.	Connect through power supply. Replace main switch. Check electrical wires. Fix the fuse. Replace the transformer.
Phase alarm.	Power supply low voltage. Phase shortage. Phase reversal. PCB problems.	Check power supply. Check power supply. Exchange two of the wires of power supply. Replace the PCB.
Pump overload.	Abnormal fluctuations of power supply. Pump blocked. Pump motor problems. Overload relay (F1) setting value error.	Check power supply. Check the pump. Check pump motor. Set the setting current of overload relay to equal to 1.1 times of motor rated current. Please refer to Mian Components for detailed description of overload relay. Reset overload relay: Wait for one minute, then press the blue button to reset.
EGO overheats.	EGO temperature setting mistakes. EGO poor temperature detecting. Heater contactor K1 and K2 problems.	Correctly set EGO temperature. (EGO temperature setting value= temperature setting value+10℃) Replace EGO. Replace the contactor.
Low liquid level.	Oil shortage.	Fill high temp. oil.
Insufficient pressure.	Insufficient water pressure of external water supply. Pressure switch failure.	Increase the water pressure of external water supply. Repay the pressure switch.
Excess process pressure.	Globe valve of mould circulating water is not open or pipe blockage. Pressure switch failure.	Check the globe valve and pipeline. Repay the pressure switch.
Temp. window displays "----"	Abnormal sensor.	Check and repair sensor.
Once running, pump output indicator lightens but pump cannot start. After a while pump still fails to run.	PCB output relay problems. Electrical circuit problems.	Check or replace the PCB. Check electrical circuit.
Differences between setting temperature and actual temperature is too big.	Too short time after machine startup. Temperature parameter setting error. Cooling water valve problems.	Wait for a while. Check temperature parameters. Please refer to the standard manual of setting parameters. Replace solenoid valve.

Temperature can't rise up.	Heater contactor problems. Heater problems. Thermocouple problems. PCB output point problems.	Replace the contactor. Replace pipe heater. Replace thermocouple. Check and repair PCB.
Circuit breaker tripping off at turning on main switch.	Short circuit of main circuit. Transformer short circuit or connected with earth wire. Problems of circuit breaker.	Check electrical wire. Replace circuit breaker.
Circuit breaker tripping off at turning on pump switch.	Pump motor coil short circuit. Problems of circuit breaker.	Check pump motor. Replace circuit breaker.
Circuit breaker tripping off after short heater output.	Heater tube short circuit or shell contact. Problems of circuit breaker.	Replace heater tube. Replace circuit breaker.



## 6. Maintenance and Repair

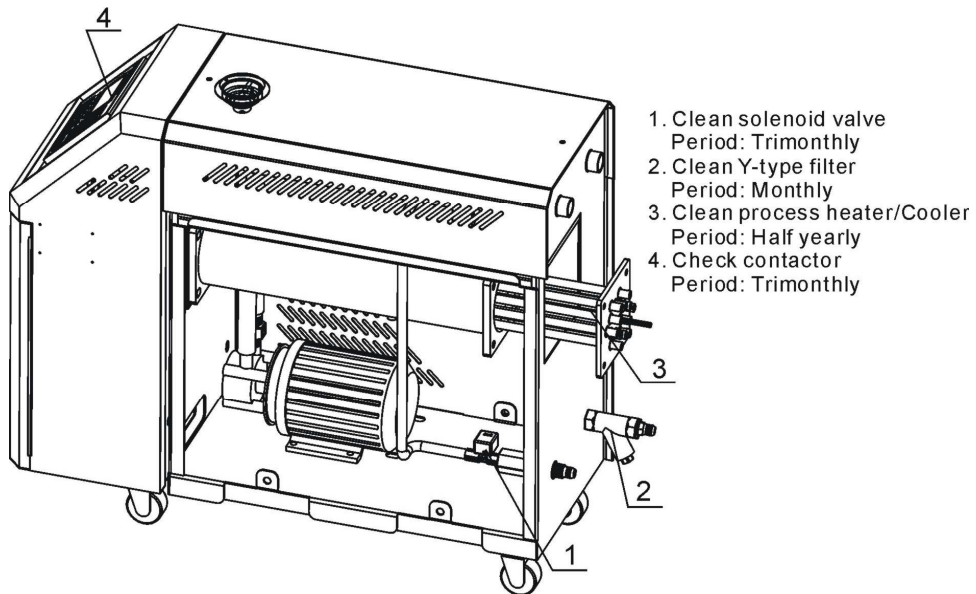

Pay attention to the following rules during maintenance:

- 1) It requires two personnel to check the machine. Firstly, reduce the temperature, cut off the power supply, and drain the oil and water; Make sure to operate after inspection with enough maintenance space.
- 2) When operating, it's dangerous to touch the machine as it is in high temperature state. The operator must stop the machine before checking and maintenance and wear safety gloves before operation.
- 3) In order to extend the life of the system and prevent accidents, periodic inspections must be carried out.
- 4) If it is still in a high temperature state during operation and before or after shutdown, operate the machine after shutdown and the temp. completely drops to below temp. of 50 °C.
- 5) Please reduce the temperature to room temperature (below 50 °C), cut off power supply and drain oil and water first while inspecting the machine;

***Please note that it is dangerous to check or tear down the machine during operation.***

## 6.1 Open the Covers

- 1) Open the top covers of the unit. (Refer to the pictures below)



Picture 6-1: Open the Covers 1

- 2) Take down the side covers. (Refer to the pictures below)

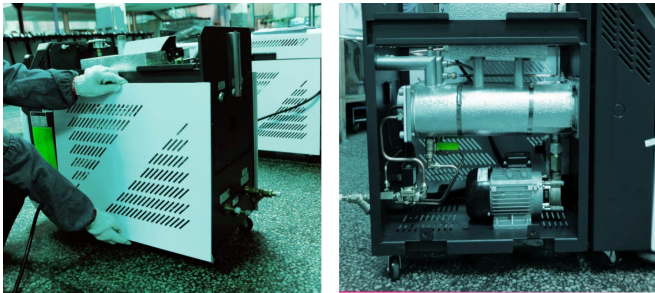

Picture 6-2: Open the Covers 2

- 3) Open the cover of control box. Screw off two butterfly screws to unlock the cover. (Refer to the pictures below)

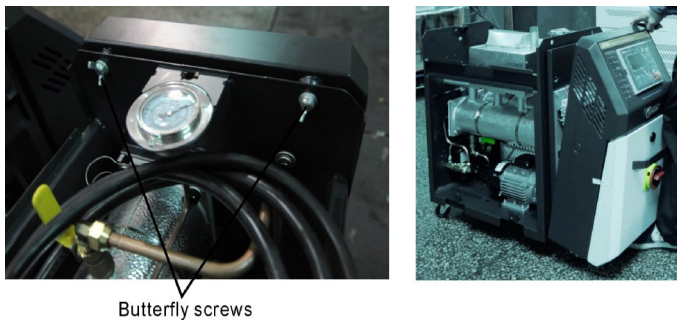

Picture 6-3: Open the Covers 3

## 6.2 Y Type Strainer

- 1) Clean soft water should be used as cooling water. Filter screen is used in the strainer to stop impurities and pollutants to enter into water pipe.
- 2) Impurities or pollutants may cause errors and bad temperature control. Clean filter screen of the strainer periodically.
- 3) Cleaning steps: turn off power and cooling water supply. Open the top cover of filter screen to clean the filter.

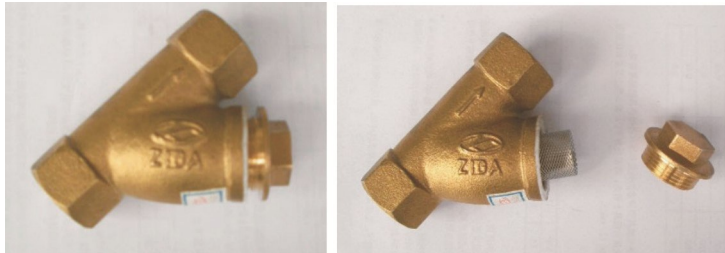

Picture 6-4: Y Type Strainer

## 6.3 Solenoid Valve

Replace solenoid valve

- 1) Open machine top cover.
- 2) Take down right side cover.
- 3) Unfix the solenoid valve for replacement.
- 4) Install the covers in a reverse order.



Solenoid valve

Picture 6-5: Solenoid Valve

## 6.4 Pipe Heater

- 1) Open machine rear cover door. (Refer to pictures below)



Picture 6-6: Pipe Heater 1

- 2) Unlock heater cap. (Refer to pictures below)



Picture 6-7: Pipe Heater 2

- 3) Install the pipe heater to the machine according to above opposite orders.

## 6.5 By-pass Globe Valve

Shut off the by-pass globe valve when water pressure gauge display value is too low.



Picture 6-8: By-pass Globe Valve

## 6.6 Maintenance Schedule

### 6.6.1 About the Machine

Model \_\_\_\_\_ SN \_\_\_\_\_ Manufacture date \_\_\_\_\_

Voltage \_\_\_\_\_  $\Phi$  \_\_\_\_\_ V Frequency \_\_\_\_\_ Hz Power \_\_\_\_\_ kW

### 6.6.2 Installation & Inspection

Check the installation space is enough as required.

Check the pipes are correctly connected.

#### Electrical installation

Voltage: \_\_\_\_\_ V \_\_\_\_\_ Hz

Fuse melting current: 1 Phase \_\_\_\_\_ A 3 Phase \_\_\_\_\_ A

Check phase sequence of power supply.

### 6.6.3 Daily Checking

Check machine startup function.

Check all the electrical wires.

### 6.6.4 Weekly Checking

Check loose electrical connectors.

Check and clean Y type filter <sup>(1)</sup>.

Check solenoid valve.

Check motor overload and phase reversal alarm function.

Check whether pipeline joints are under looseness.

Check the sensitivity of EGO.

### 6.6.5 Trimonthly Checking

Check level switch.

Check the contactor <sup>(2)</sup>.

Replace the hot kerosene with a using temperature above 160 degree <sup>(3)</sup>.

### 6.6.6 Half-yearly Checking

Check damaged pipes.

Clean process heater/cooler.

Check indicator and buzzer.

Replace the hot kerosene with a using temperature above 120~160 degree <sup>(4)</sup>.

### 6.6.7 Yearly Checking

Replace the hot kerosene with a using temperature above 120 degree <sup>(5)</sup>.

### 6.6.8 3 year Checking

- PC board renewal.
- No fuse breaker renewal.

- Note: (1). Y-type filter has the function of filling water cooling protection effect, be sure the waterway are clear to avoid cooling failure.
- (2). Manufacturer laboratory data for AC contactor is two million times in life. we suggest service life for one million four hundred thousand times, if work eight hours per day, recommended replacing frequency is 1.5 years, if work day and night, replacement is suggested to be done every six months.
  - (3). Hot kerosene coke will influence the detection accuracy of internal temperature probe and the efficiency of heat elements, three months replacing frequency is suggested.
  - (4). Hot kerosene coke will influence the detection accuracy of internal temperature probe and the efficiency of heat elements, six months replacing frequency is suggested.
  - (5). Hot kerosene coke will influence the detection accuracy of internal temperature probe and the efficiency of heat elements, suggested replacing frequency is one year.

Appendix 1:

SHINI Comm.Variable Table (1)

STM Comm. Variables					Comm. Protocol: MODBUS-RTU
D-Map(4 0001+i)	English	Chinese	Range	Description	Type
1	CONTROL PV	Control temp.	-50 ~ 500	※1(Different displays depending on whether the temp. unit ° C has a decimal point.)	read only
2	RET PV	Return water temp.	-50 ~ 500		read only
3	ENT PV	Output water temp.	-50 ~ 500		read only
4	SV	Control target value	-50 ~ 500		read only
5	RTC YEAR	Current year	0 ~ 99	2000(0), 2001(1), ..., 2099(99)	read only
6	RTC MONTH	Current month	1 ~ 12		read only
7	RTC DATE	Current date	1 ~ 31		read only
8	RTC DAY	Current week	0 ~ 6	Sun.(0), Mon. (1), Tues.(2), ..., Sat.(6)	read only
9	RTC HOUR	Current hour	0 ~ 23		read only
10	RTC MINUTE	Current minute	0 ~ 59		read only
11	RTC SECOND	Current secs.	0 ~ 59		read only
12	CONTROL STATUS	Control status	0 ~ 3	Fault(0), stop control(1), In controlling(2), Auto-tuning(3)	read only
13	MMI STATUS	Running status	0 ~ 255	※2 (Operate it with bit address)(as shown in	read only



				Appendix2)	
14	DO STATUS	Contact output status	0 ~ 255	※2 (Operate it with bit address)(as shown in Appendix2)	read only
15	DI STATU	Contact input status	0 ~ 255	※2 (Operate it with bit address)(as shown in Appendix2)	read only
16	ALARM STATUS	Alarm status	0 ~ 255	※2 (Operate it with bit address)(as shown in Appendix2)	read only
17	CONTROL PV ERROR	Control temp. input alarm	0 ~ 255	※2 (Operate it with bit address)(as shown in Appendix2)	read only
18	RET PV ERROR	Return water temp. input alarm	0 ~ 255	※2 (Operate it with bit address)(as shown in Appendix2)	read only
19	ENT PV ERROR	Water outlet temp. input alarm	0 ~ 255	※2 (Operate it with bit address)(as shown in Appendix2)	read only
20	REMOTE ERROR	Remote control input alarm	0 ~ 255	※2 (Operate it with bit address)(as shown in Appendix2)	read only
21	KEY STATUS	KEY key status	0 ~ 255	※2 (Operate it with bit address)(as shown in Appendix2)	read only
22	LED STATUS	LED indicator status	0 ~ 255	※2 (Operate it with bit address)(as shown in Appendix2)	read only
100	HOUT	Heating end output	0 ~ 100%		read only
101	COUT	Cooling end output	0 ~ 100%		read only
102		Backlight time	0 ~ 255	0 ~255	read /write



104	RUN/RESET KEY	RUN/RESET KEY	0, 1	1 = Key (button) operation. After this operation, it will be automatically reset to 0.	write only
105	AUTO-TUNING KEY	AUTO-TUNING KEY	0, 1		write only
106	AUTO-START KEY	AUTO-START KEY	0, 1		write only
107	SUCTION KEY	SUCTION KEY	0, 1		write only
108	COOLING KEY	COOLING KEY	0, 1		write only
109	BUZZER OFF KEY	BUZZER OFF KEY	0, 1		write only
110	SUCTION OFF KEY	SUCTION OFF KEY	0, 1		write only
112		Reset	1		write only
120		Flow value		Unit: 0.1L/min	read only
125		Pressure value		Unit:0.1bar	read only
150		Emptying temp.	0-120.0°C	When the PV temp. is less than [Emptying temp.], the reverse emptying can be started.	read /write
151		Emptying time	60 secs.	0-600 secs.	read /write
200	SV	Control target value (°C)	-50 ~ 500°C	※1(Different displays depending on whether the temp. unit °C has a decimal point.)	read /write
201	PB	Heating control belt	0 ~ 550°C	※1(Different displays depending on whether the temp. unit °C has a	read /write

				decimal point.)	
202	TI	Integral time	1 ~ 3600s		read /write
203	TD	Differential time	1 ~ 3600s		read /write
204	PBC	Cooling control zone	0 ~ 550°C	※1(Different displays depending on whether the temp. unit ° C has a decimal point.)	read /write
205	CT	Heating control cycle	1 ~ 100s		read /write
206	CTC	Cooling control cycle	1 ~ 100s		read /write
300	PHASE ALARM	Phase detection	0, 1	Unuse (0), use(1)	read /write
301	DEV1 ALARM	Output water temp. deviation	0 ~ 550°C	※1(Different displays depending on whether the temp. unit ° C has a decimal point.)	read /write
302	DEV2 ALARM	Return water temp. deviation	0 ~ 550°C		read /write
303	TURB ALARM	Interference alarm	0 ~ 550°C		read /write
304	HEATER ALARM	Heater alarm	0 ~ 3600s		read /write
401	SUB HEATING	Auxiliary output	0 ~ 550°C	※1(Different displays depending on whether the temp. unit ° C has a decimal point.)	read /write
402	COOLING TEMP	Cooling temp.	-50 ~ 500°C		read /write
500	H.LIMIT TEMP	Upper limit temp.	-50 ~ 500°C	※1(Different displays depending on whether the temp. unit ° C has a	read /write

				decimal point.)	
501	L.LIMIT TEMP	Lower limit temp.	-50 ~ 500°C		read /write
502	TEMP UNIT	Temp. unit	0, 1	°C(0), °F(1)	read /write
503	TEMP DEGREE	Decimal point	0, 1	0.1(0), 1(1)	read /write
504	CTL TEMP BIAS	Control temp. correction	-550 ~ 550°C	※1(Different displays depending on whether the temp. unit ° C has a decimal point.)	read /write
505	RET TEMP BIAS	Return water temp. correction	-550 ~ 550°C		read /write
506	ENT TEMP BIAS	Output water temp. correction	-550 ~ 550°C		read /write
600	NOW YEAR	Year setting	0 ~ 99	2000(0), 2001(1), ..., 2099(99)	read /write
601	NOW MONTH	Month setting	1 ~ 12		read /write
602	NOW DATE	Date setting	1 ~ 31		read /write
603	NOW DAY	Week setting	0 ~ 6	Sun.(0), Mon. (1), Tues.(2), ..., Sat.(6)	read /write
604	NOW HOUR	Hour setting	0 ~ 23		read /write
605	NOW MINUTE	Minute setting	0 ~ 59		read /write
606	SCHDULE DAY	Week reserve setting	0 ~ 127	Sun.(0), Mon. (1), Tues.(2), ..., Sat.(6)	read /write
607	AUTO-START HOUR	Reserve auto start hr. setting	0 ~ 24	Unuse (00:00)	read /write
608	AUTO-START MINUTE	Reserve auto start min.	0 ~ 59		read /write

		setting			
609	AUTO-END HOUR	Reserve auto shutdown hr. setting	0 ~ 24	Unuse (00:00)	read /write
610	AUTO-END MINUTE	Reserve auto shutdown min. setting	0 ~ 59		read /write
611	AS SETTING TIME	Check time setting	0 ~ 9999	Unuse (00:00)	read /write
612	RUNNING TIME	Device using time	0 ~ 9999		read only
700	LANGUAGE	Language setting	0, 1	Chinese(0), English(1)	read /write
702	PASSWORD	Password setting	0 ~ 9999		read /write
703	RET/ENT DISP	Return water output temp.	0, 1	Unuse (0), use(1)	read /write
704	W-FILL TM T1	Water refilling time T1	0 ~ 600s		read /write
705	W-FILL TM T2	Water refilling time T2	0 ~ 60s		read /write
706	RET/ENT DISP	Return loop display settings	0, 1, 2, 3	Display control loop, control+ return medium, control + mould, control+ return medium + mould	read /write

SHINI Comm.Variable Table (2)

STM Comm. Variables					Comm. Protocol: MODBUS-RTU
D-Map(40 001+i.J)	Name	BIT			
		0	1	2	3
		4	5	6	7

13	MMI STATUS	Control	Cooling	Auto-tuning	Suction
		Reserve	Buzzer Off	--	Input power
14	DO STATUS	Pump forward action	Pump forward action	Water refilling	Suction
		Alarm	Breaker	Air	--
15	DI STATUS	Pump overload	EGO	Low pressure	High pressure
		Low liquid level	High liquid level	--	Start control
16	ALARM STATUS	Phase alarm	Temp. alarm	Deviation alarm	Interference alarm
		Heating alarm	--	--	--
17	CONTROL PV ERROR	--	-Over	+Over	Sensor Open
		AD Error-	--	--	--
18	RET PV ERROR	--	-Over	+Over	Sensor Open
		AD Error-	--	--	--
19	ENT PV ERROR	--	-Over	+Over	Sensor Open
		AD Error-	--	--	--
20	REMOTE ERROR	--	-Over	+Over	Input Open
		AD Error-	--	--	--
21	KEY STATUS	RUN	AUTO-TUNING	AUTO-START	SUCTION OFF
		COOLING	SUCTION	BUZZER OFF	Power
<b>D-Map(40 001+i.J)</b>	<b>Name</b>	<b>BIT</b>			
		<b>0</b>	<b>1</b>	<b>2</b>	<b>3</b>
		<b>4</b>	<b>5</b>	<b>6</b>	<b>7</b>
22	STATUS 1	RUN	AUTO-TUNING	SUCTION	COOLING
		BUZZER OFF	AUTO-START	SUCTION OFF	F
	STATUS 2	POWER	HEATER OUTPUT	AUXILIARY HEATING OUTPUT	COOLING OUTPUT
		PUMP	PUMP	WATER	ALARM

		FORWARD ACTION	REVERSE ACTION	REFILLING	
--	--	-------------------	-------------------	-----------	--

MODBUS -RTU uses the RS485serial port.

Note: The address minimum value is 1. If it readis and writies from zero, an error will occur.