

STM-WF Series

"Large Flow" Water Heater

Date: May. 2018

Version: Ver.E (English)



Contents

1. General Description	7
1.1 Coding Principle	8
1.2 Feature	8
1.3 Accessory option	8
1.4 Technical Specifications	10
1.4.1 Specification	10
1.4.2 Pump Performance	11
1.4.3 Reference Formula of Mould Controllers Model Selection	11
1.5 Safety Regulations	12
1.5.1 Safety Signs and Labels	12
1.5.2 Signs and Labels	13
1.5.3 Operation Regulations	14
1.6 Exemption Clause	15
2. Structure Characteristics and Working Principle	16
2.1 Main Functions	16
2.1.1 Working Principle	16
2.2 Operation Procedures	17
2.2.1 Installation steps for options water manifold (dewaxing)	17
2.2.2 Installation steps for options water manifold (welding)	17
3. Installation and Debugging	19
3.1 Installation Space	19
3.2 Mould and Water Coupling	19
3.3 Power Supply	20
4. Operation Guide	21
4.1 Control Panel	21
4.2 Menu Introduction	23
4.2.1 Main screen	23
4.2.2 MENU Screen	23
4.3 Parameter Table	24
4.3.1 Parameter Setting Table	24

4.3.2	Output Setting.....	27
4.3.3	Alarm Settings	28
4.3.4	Startup for refilling.....	29
4.3.5	Auto refilling process	29
4.4	Errors and Causes	30
5.	Trouble-shooting	31
6.	Maintenance and Repair	33
6.1	Open the Covers	34
6.2	Y Type Strainer	35
6.3	Solenoid Valve	35
6.4	Pipe Heater	36
6.5	By-pass Globe Valve.....	36
6.6	Printed Circuit Board	37
6.7	Displayer Terminal Connecting Diagram.....	39
6.8	Maintenance Schedule.....	40
6.8.1	About the Machine.....	40
6.8.2	Installation & Inspection.....	40
6.8.3	Daily Checking.....	40
6.8.4	Weekly Checking	40
6.8.5	Trimonthly Checking.....	40
6.8.6	Half-yearly Checking.....	40
6.8.7	Yearly Checking.....	41
6.8.8	3 year Checking.....	41

Table Index

Table 1-1:	Specification	10
Table 4-2:	Control Setting	24
Table 4-3:	Alarm Setup.....	24
Table 4-4:	Output Setting.....	24
Table 4-5:	Temp. Setting	25
Table 4-6:	Time Setting	25
Table 4-7:	One Week ON/OFF Setup.....	25

Table 4-8: Communication Setup	26
Table 4-9: Instrument Setup	26
Table 4-10: Refilling Setup	26

Picture Index

Picture 1-1: Pump Performance	11
Picture 2-1: Working Principle	16
Picture 3-1: Installation Space	19
Picture 3-2: Mould and Water Couplings 1	19
Picture 3-3: Mould and Water Couplings 2	20
Picture 3-4: Mould and Water Couplings 3	20
Picture 4-1: Control Panel.....	21
Picture 4-2: Main Menu Screen	23
Picture 4-3: MENU Screen	23
Picture 6-1: Open the Covers 1	34
Picture 6-2: Open the Covers 2	34
Picture 6-3: Open the Covers 3	34
Picture 6-4: Y Type Strainer	35
Picture 6-5: Solenoid Valve	35
Picture 6-6: Pipe Heater 1	36
Picture 6-7: Pipe Heater 2	36
Picture 6-8: By-pass Globe Valve.....	36

1. General Description



Read this manual carefully before operation to prevent damage of the machine or personal injuries.

STM-WF series "Large Flow" water heater are used to heat up the mould and maintain temperature, although they can be used in other similar applications. High temperature water from the mould is returned to the cooling tank and cooled by direct cooling. It is then pressurised by the high-pressure pump, sent to the heating tank and finally to the mould with a constant temperature. The HANYOUNG temperature controller can maintain an accuracy of $\pm 0.5^{\circ}\text{C}$.



Model: STM-607WF

1.1 Coding Principle

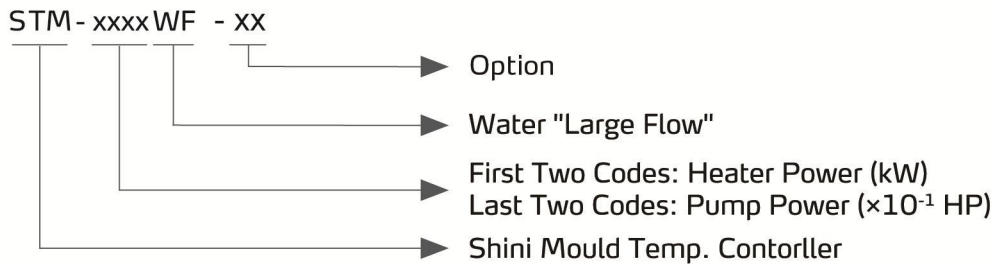

1.2 Feature

- Controller adopts 3.2" LCD for easy operation.
- Equipped with the design of 7-day automatic start/stop timer. LCD screen can be converted between Chinese and English. The unit of temperature can be converted between °F and °C.
- P.I.D multi-stage temperature control system can maintain a mould temperature with accuracy of $\pm 0.5^{\circ}\text{C}$.
- Multiple safety devices including power reverse phase protection, pump overload protection, overheat protection and low level protection that can automatically detect abnormal performance and indicate this via visible alarm.
- Adopts large-flow pump with high stable performance, which especially suitable for extrusion molding and applications alike.
- Direct cooling can achieve optimal cooling effect; automatic water backup can rapidly cool down temperature to set point.
- Advanced design of cycle can avoid high pressure explosion when system is under faults.
- Adopted Ethernet communication function to realize central
- monitoring online.

1.3 Accessory option

- Teflon hose is optional.
- Display of mould temperature and mould return water temperature is optional.
- Buzzer is optional .Add "B"at the model behind.

All service work should be carried out by a person with technical training or corresponding professional experience. The manual contains instructions for both handling and servicing. Chapter 6, which contains service instructions intended for service engineers. Other chapters contain instructions for the daily operator.

Any modifications of the machine must be approved by SHINI in order to avoid personal injury and damage to machine. We shall not be liable for any damage caused by unauthorized change of the machine.

Our company provides excellent after-sales service. Should you have any problem during using the machine, please contact the company or the local vendor.

Headquarter and Taipei factory:

Tel: (886) 2 2680 9119

Shini Plastics Technologies (Dongguan), Inc:

Tel: (86) 769 8111 6600

Shini Plastics Technologies India Pvt.Ltd.:

Tel: (91) 250 3021 166

1.4 Technical Specifications

1.4.1 Specification

Table 1-1: Specification

Model STM-	607WF	910WF	1220WF	2430WF※	3650WF※	4875WF※
Ver.	E	E	E	E	E	E
Max. Temp.	120℃					
Pipe heater (kW)	6	9	12	24	36	48
Pump power (kW) (50/60Hz)	0.55/0.55	0.75/0.75	1.1/1.5	2.2/2.2	3.0/4.0	5.5/5.5
Max. pump flow (L/min) (50/60Hz)	58/67	116/133	168 / 216	267 / 333	267 / 398	533 / 580
Max. pump pressure (bar) (50/60Hz)	2.8 / 2.6	2.8 / 2.6	2.9 / 2.7	2.9 / 2.9	3.4 / 4.3	4.5 / 3.8
Heating tank NO.	1	1	1	2	3	4
Heating tank capacity (L)	3.0	3.0	3.2	7.2	12.0	16.0
Cooling method	Direct					
Mould coupling* (inch)	1(1×2)		1 ¹ / ₂ (1×2)			
Inlet / Outlet (inch)	1 / 1		1 ¹ / ₂ (1×2)			
Dimensions (mm) (H×W×D)	655×320×750	655×320×790	675×320×830	855×434×840	855×474×940	955×474×1100
Weight (kg)	60	85	85	156	180	242

Note: 1) "※" tands for vertical pump, "*" stands for options.

We reserve the right to change specifications without prior notice.

- 2) In order to maintain stable temp. of heat transfer media dia, cooling water pressure should be no less than 2 bar , but also no more than 5 bar.
- 3) Pump testing standard : Power of 50 / 60Hz, purified water in 20℃. (There is ±10% tolerance for either max. flowrate or max.pressure).
- 4) Power supply: 3Φ, 230/400/460/575VAC, 50/60Hz.

1.4.2 Pump Performance

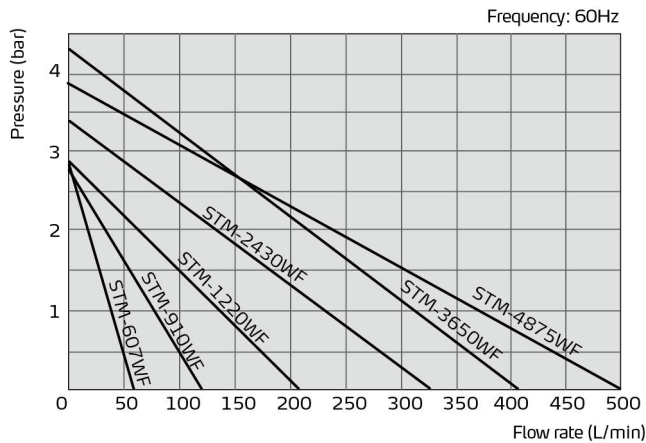

Picture 1-1: Pump Performance

1.4.3 Reference Formula of Mould Controllers Model Selection

Heater Power (kW) = mould weight (kg) × mould specific heat (kcal/kg°C) × temperature difference between mould and environment (°C) × safety coefficient / heating duration / 860

Note: safety coefficient can select a value from 1.3 to 1.5.

Flow Rate (L/min) = heater power (kw) × 860 / [heating medium specific (kcal/kg°C) × heating medium density (kg/L) × in/outlet temperature difference (°C) × time (60)]

Note: Water specific heat = 1kcal/kg°C

Heating medium oil specific heat = 0.49kcal/kg°C

Water density = 1kg/L

Heating medium oil density = 0.842kg/L

1.5 Safety Regulations

Strictly abide by the following safety regulations to prevent damage of the machine or personal injuries.

1.5.1 Safety Signs and Labels



Danger!

The unit is designed to endure high temp, and high pressure. For safe operation, do not remove the covers or switches.



Attention!

The unit should be operated by qualified personnel only.

During operation, avoid wearing gloves or clothes that may cause danger.

Turn off main switch when power supply is off.

Stop the unit when there may be power supply problems caused by static electricity.

Put on safety gloves and shoes during installation or relocation.

Components from our company can only be used for replacement.



Warning!

Do not touch the switch with wet object or hands.

Do not use the machine before fully aware of its performance.

Be careful not to touch or hit the switch or sensor.

Please keep enough operation space, and keep away obstacles.

To avoid producing statics, clean the floor from oil or water to keep a dry environment.

Protect the machine against severe vibration or collision.

Do not remove safety signs or make it dirty.



Drunken, medicine-taking, or men without proper judgement should not operate the machine.



Warning!

High temperature, take care of hands! This label is attached on the surface of heating parts.

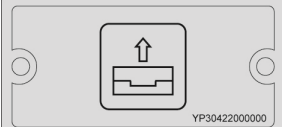
1.5.2 Signs and Labels

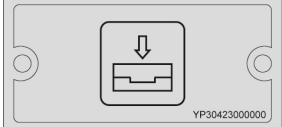
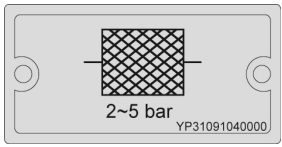
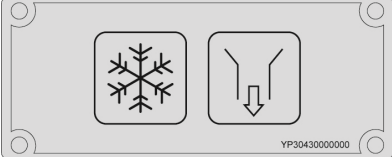
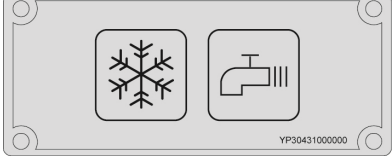
 <table border="1"> <thead> <tr> <th colspan="2">Maintenance Schedule</th> </tr> <tr> <th>Item</th> <th>CT</th> </tr> </thead> <tbody> <tr> <td>Check whether pipeline joints are under looseness.</td> <td>Weekly</td> </tr> <tr> <td>Clean Y-type filter.</td> <td>Weekly</td> </tr> <tr> <td>Clean solenoid valve.</td> <td>Monthly</td> </tr> <tr> <td>Check the sensitivity of EGO.</td> <td>Weekly</td> </tr> <tr> <td>Check level switch.</td> <td>Trimonthly</td> </tr> <tr> <td>Check contactor.</td> <td>Trimonthly</td> </tr> <tr> <td>Clean process heater/cooler.</td> <td>Semiyearly</td> </tr> <tr> <td>Check indicator and buzzer.</td> <td>Semiyearly</td> </tr> <tr> <td>PCB renewal.</td> <td>Every 3 year exchange</td> </tr> <tr> <td>No fuse breaker.</td> <td>Every 3 year exchange</td> </tr> <tr> <td rowspan="3">Thermal oils</td> <td>≤ 120 °C</td> <td>Renew annually</td> </tr> <tr> <td>120 °C~160 °C</td> <td>Renew semiyearly</td> </tr> <tr> <td>> 160 °C</td> <td>Renew trimonthly</td> </tr> </tbody> </table> <p>Note: Please refer to the Manual for detailed operations. YP311580730</p>	Maintenance Schedule		Item	CT	Check whether pipeline joints are under looseness.	Weekly	Clean Y-type filter.	Weekly	Clean solenoid valve.	Monthly	Check the sensitivity of EGO.	Weekly	Check level switch.	Trimonthly	Check contactor.	Trimonthly	Clean process heater/cooler.	Semiyearly	Check indicator and buzzer.	Semiyearly	PCB renewal.	Every 3 year exchange	No fuse breaker.	Every 3 year exchange	Thermal oils	≤ 120 °C	Renew annually	120 °C~160 °C	Renew semiyearly	> 160 °C	Renew trimonthly	<p>Please according to schedule to make regular maintenance.</p>
Maintenance Schedule																																
Item	CT																															
Check whether pipeline joints are under looseness.	Weekly																															
Clean Y-type filter.	Weekly																															
Clean solenoid valve.	Monthly																															
Check the sensitivity of EGO.	Weekly																															
Check level switch.	Trimonthly																															
Check contactor.	Trimonthly																															
Clean process heater/cooler.	Semiyearly																															
Check indicator and buzzer.	Semiyearly																															
PCB renewal.	Every 3 year exchange																															
No fuse breaker.	Every 3 year exchange																															
Thermal oils	≤ 120 °C	Renew annually																														
	120 °C~160 °C	Renew semiyearly																														
	> 160 °C	Renew trimonthly																														
 <p>YP30422000000</p>	<p>From mould: connector for circulating water/oil coming from mould.</p>																															
 <p>YP30425000000</p>	<p>Pump pressure meter: indicating actual pressure of system.</p>																															
 <p>YP30423000000</p>	<p>To mold: connector for circulating water/ oil to go to mould.</p>																															
 <p>2~5 bar YP31091040000</p>	<ol style="list-style-type: none"> To maintain temperature consistency, cooling water pressure must be higher than 2 bar at all time, but should never exceed 5 bar in any case. Clean Y-shape Cooling Water Strainer periodically to ensure perfect cooling capacity. 																															
 <p>YP30430000000</p>	<p>Water outlet: drainage outlet.</p>																															
 <p>YP30431000000</p>	<p>Water inlet: inlet for replenishing water and cooling water.</p>																															

Please abide by the safety guide when you operate the machine so as to prevent damage of the machine and personal injuries.



All electrical components should be installed by qualified electricians. Turn off main switch and control switch during repair and maintenance.



Warning! High voltage!

This mark is attached on the cover of the control box.



Warning! Be careful!

Be more careful when this mark appears.

1.5.3 Operation Regulations

- 1) Before operation, make sure that cooling water is clean soft water without pollutants.
 - ※ Low quality water brings limescales, which may cause problems.
- 2) If problems of drainage or bad temperature control are noted, please clean solenoid valve and cooling water inlet and outlet.
- 3) Do not move the unit when it is in operation.
- 4) When in need of repairing, wait until oil temperature falls below 30°C.
- 5) Motor overload may be caused by phase shortage, pipe obstruction, broken bearing, etc. Motor overload relay will trip off to stop the machine when this happens. Fixing the problems, press RESET on overload relay to clear the alarm.
- 6) Before turn off the pump, wait until oil temperature falls blow 50°C. Or the life of the unit would be affected.
- 7) If the setting temperature is below 100°C, then the pressure switch setting value should be 1.5-2 bar; If the setting temperature sets between 100°C and 200°C, then the recommendable pressure switch setting value should be 2.8 bar. If the cooling water pressure is too low, then the pressure switch setting value can be adjusted properly to ensure normal running. However, it may affect the limitation of setting temperature or cause unstable temperature control.
- 8) Please connect the cooling water outlet with high temperature resistant

pipe when temperature is above 100°C.

1.6 Exemption Clause

The following statements clarify the responsibilities and regulations born by any buyer or user who purchases products and accessories from Shini (including employees and agents).

Shini is exempted from liability for any costs, fees, claims and losses caused by reasons below:

1. Any careless or man-made installations, operation and maintenances upon machines without referring to the Manual prior to machine using.
2. Any incidents beyond human reasonable controls, which include man-made vicious or deliberate damages or abnormal power, and machine faults caused by irresistible natural disasters including fire, flood, storm and earthquake.
3. Any operational actions that are not authorized by Shini upon machine, including adding or replacing accessories, dismantling, delivering or repairing.
4. Employing consumables or oil media that are not appointed by Shini.

2. Structure Characteristics and Working Principle

2.1 Main Functions

The STM-WF series of "Large Flow" water heater are used to heat up the mould and maintain its temperature, although they can be also apply in other similar applications. High temperature water from the mould return is cooled by direct design cooling and then sent to the pipe heater via high-pressure pump for heating to a constant temperature. With our optimized design, water can reach a maximum of 120°C and the HANYOUNG temperature controller can maintain an accuracy of $\pm 0.5^{\circ}\text{C}$.

2.1.1 Working Principle

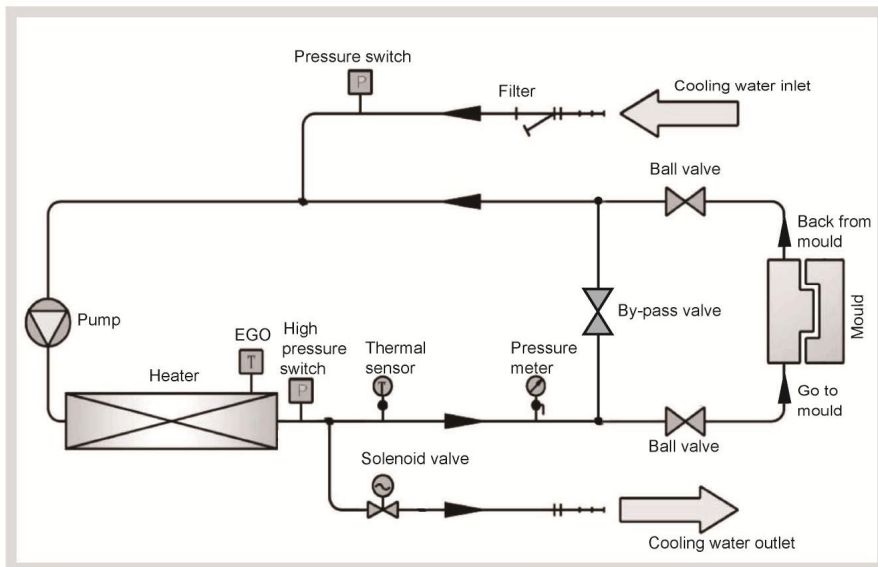

Picture 2-1: Working Principle

High temperature water returns to the machine and then be pressured by pump to the heater. After being heated, water will be forced to mould and continue the circle. In the process, if the temperature is too high, the system will activate the solenoid valve to let cooling water cool down the temp. Directly until the water is down to the system requirement. If the temp. keep increasing and reach to the set point of EGO, system will alarm and stop operation. The system will have low pressure alarm and stop working if cooling water pressure doesn't reach set point.

2.2 Operation Procedures

2.2.1 Installation steps for options water manifold (dewaxing)

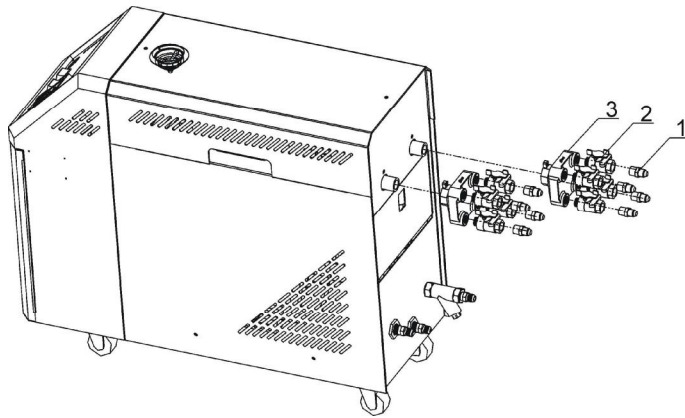

- 1) Install copper joint to the level valve.
- 2) Install level valve with copper joint to the dewaxing water manifold.
- 3) Install water manifold to the machine.
- 4) Install Teflon to copper joint.

Note: For the operating temperature not higher than 200 °C, Teflon with temperature resistance 200 °C is usable; for the operating temperature from 200 to 300 °C, must use Teflon with temperature resistance 300 °C.

2.2.2 Installation steps for options water manifold (welding)

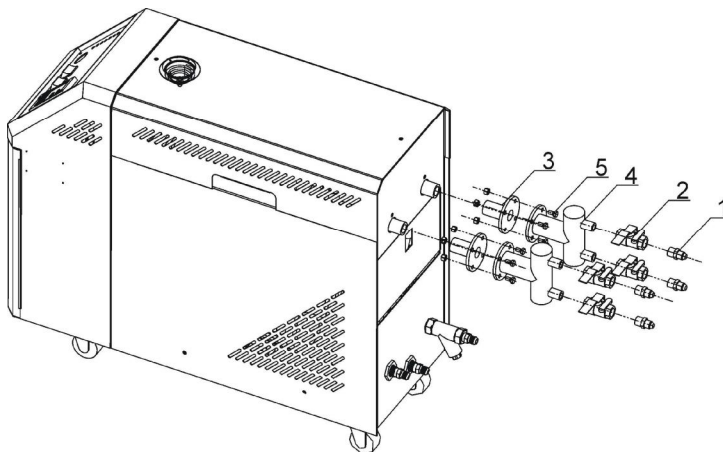

- 1) Install copper joint to the level valve.
- 2) Install level valve with copper joint to the welding water manifold.

- 3) Install water manifold to the machine.
- 4) Connect water manifold with manifold joint via screws.
- 5) Install Teflon to copper joint.

Note: For the operating temperature not higher than 200 °C, Teflon with temperature resistance 200 °C is usable; for the operating temperature from 200 to 300 °C, must use Teflon with temperature resistance 300 °C.

3. Installation and Debugging

3.1 Installation Space

During installation of the machine, keep at least 500mm installation space around the machine as shown by the picture. Do not install the machine in a position crowded with other objects. This would cause inconvenience to operation, maintenance and repair.

Do not sit on the machine.

Keep away flammable and explosive goods.



Picture 3-1: Installation Space

3.2 Mould and Water Coupling

- 1) It is necessary, while connecting from the access to mould, to use two spanners to fix the switching connector and ball valve before screw tightly the horn nut of the connection pipe, otherwise water might leaks from the machine.

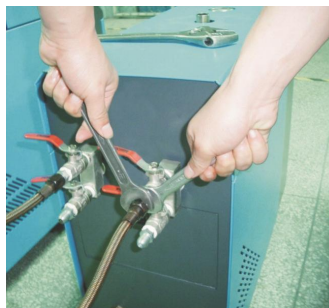

Picture 3-2: Mould and Water Couplings 1

- 2) Unused mould couplings can be connected with each other by a teflon pipe, as shown in.

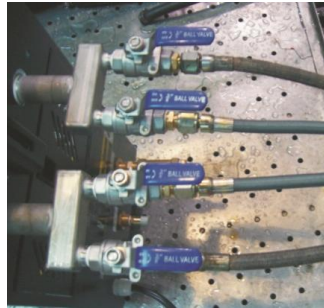

Picture 3-3: Mould and Water Couplings 2

Note: Cooling water inlet and outlet as shown by the Figure. Please do not connect reversely. Please connect the cooling water outlet with high temperature resistant pipe when temperature is above 100 °C.



Cooling water outlet
Cooling wate inlet

Picture 3-4: Mould and Water Couplings 3

- 3) Connect cooling water inlet with water supply and cooling water outlet with a drainage pipe. After that, turn on water supply.

3.3 Power Supply

Make sure that power supply is the same as required before installation.

Mould heater are generally set to be used with 3Φ400V power supply or other specifications according to customers' requirement.

4. Operation Guide



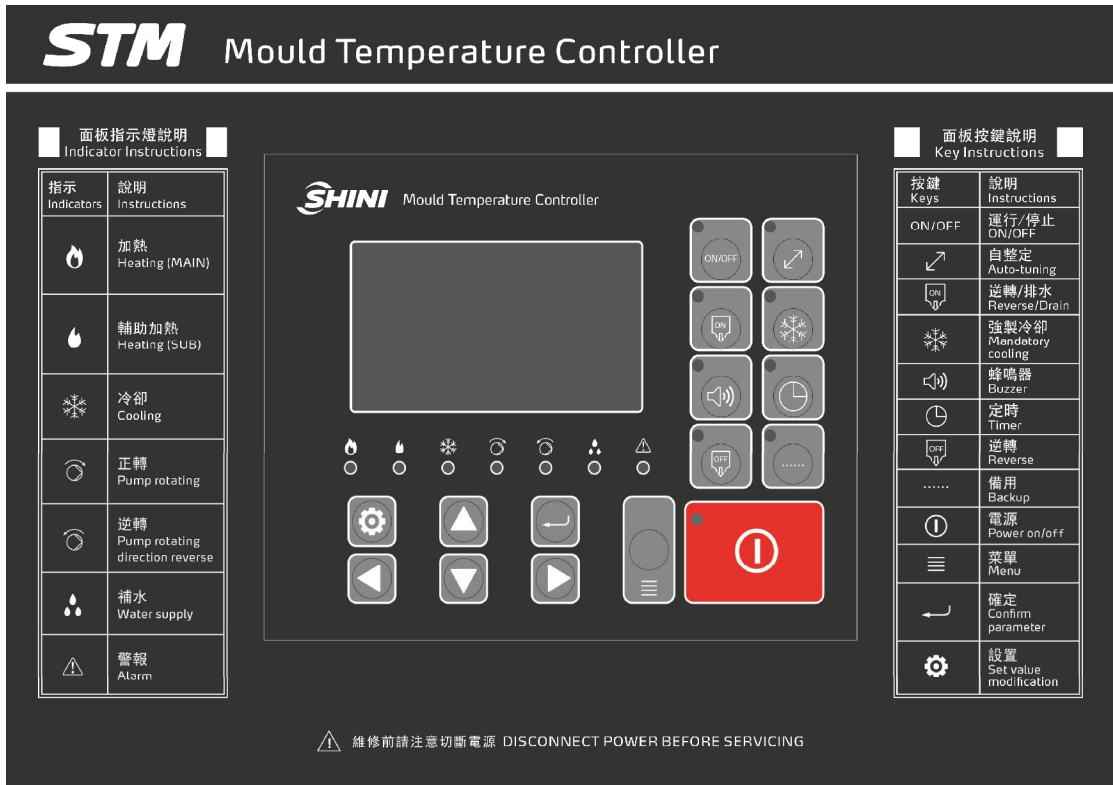











4.1 Control Panel



Picture 4-1: Control Panel

Table 4-1: Control Panel

No.	Name	Functions	Remarks
	Heating(Main)	Heating output indicator	-
	Heating(SUB)	Auxiliary heating output indicator	-
	Cooling	Cooling indicator	-
	Pump rotating	Display pump positive action indicator	-
	Pump rotating direction reverse	Pump reverse action indicator	-
	Water supply	Water refilling indicator	-
	Alarm	Send alarm indicator	Refer to table 4-2 for errors instruction.
ON/OFF	ON/OFF	Run/stop key	-

No.	Name	Functions	Remarks
	Auto-tuning	Auto tuning key	-
	Reverse/Drain	Reverse running/dischage	-
	Mandatory cooling	Forced cooling key	Hold the button for 2 secs to enable force cooling. It stop heating while enable 100% cooling. It stops after the temperutre drops below Cooling Temp.
	Buzzer	Buzzer off switch	After press" BUZZER" button, " BUZZER" LED on, Buzzer and alarm relay in idle mode even error occurs.
	Timer	Reserved timing key	-
	Reverse	Reverse key	-
.....	Backup	Backup key	-
	Power ON/OFF	Power on/off key	-
	Menu	Menu key	Parameter confirmation
	Confirm parameter	Confirm key	-
	Set valve modification	Setting key	-
	-	Up key	-
	-	Down key	-
	-	Left key	-
	-	Right key	-

4.2 Menu Introduction

4.2.1 Main screen

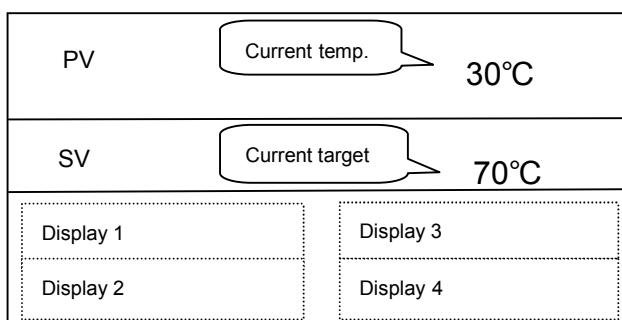

Picture 4-2: Main Menu Screen

Display 1: Display system time

Display 2: Reserved time (reserve startup) / output percentage (start temp.control)

Display 3: System state / return water temp.(Return water and mould temp. display power consumption, and press SET key on the main screen, it displays the temp. of return water).

Display 4: System state/mould temp. (Return water and mould temp. display power consumption, and press SET key on the main screen, it displays mould temp.)

Notes: The SV value range varies from different models.

4.2.2 MENU Screen

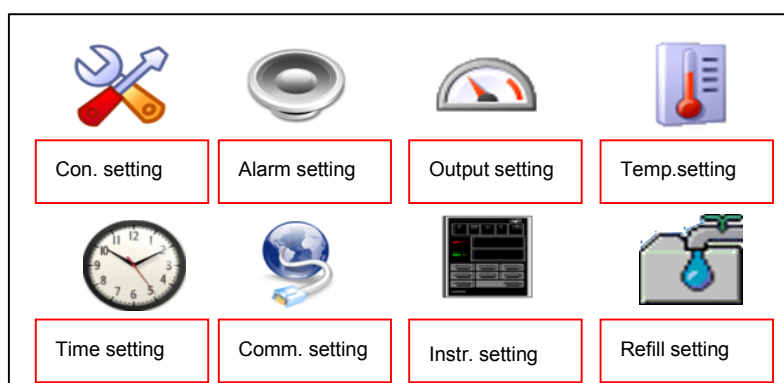

Picture 4-3: MENU Screen

In the main screen, press the <MENU>key, it pops up the password prompt, and input the password to enter the MENU screen, the initial password is 0000.

4.3 Parameter Table

4.3.1 Parameter Setting Table

Table 4-2: Control Setting

Parameter	Description	Range	Default
P	proportional band	1-100℃(2 -212)	13℃(55)
I	heating integral time	1-999S	100S
D	heating to differential time	1-999S	15S
heating cycle	heating output cycle	3-60S	15S
cooling cycle	cooling output cycle	1-30S	15S

Table 4-3: Alarm Setup

Parameter	Description	Range	Default
Phase detection	for three-phase detection	use/not use	not use
Return water temp.	Control temp. and return temp. deviation alarm (only effective in normal humidity control)	0-100℃(0= not use)	0
Mould temp. deviation	Control temp. and mould temp. deviation alarm (only effective in normal humidity control)	0-100℃(0= not use)	0
Disruption alarm	Temp. sudden drop alarm	0-300℃(0= not use)	0
Heater alarm	It doesn't reach set temp. in required time	0-3600S	0
Over temp. alarm	PV>SV+overheat alarm set temp., it alarms and stops	0-50℃	15℃

Table 4-4: Output Setting

Parameter	Description	Range	Default
Auxiliary output	auxiliary output OFF temp.	0-300℃(0= not use)	0
Cooling temp.	forced cooling temp.	0-100℃(0= not use)	35℃
Overhaul temp.	set machine running time before maintenance	0-10000H(0= not use)	0
Total running time	total machine running time		

Table 4-5: Temp. Setting

Parameter	Description	Range	Default
Temp. upper limit	SV upper limit temp. can be set	0-300℃	300℃
Temp. lower limit	SV upper lower temp. can be set	0-300℃	0℃
Temp. unit	℃/ℱ setting	℃、ℱ	℃
Decimal point	temp.value of decimal point can be set	0.1、1	1
Control temp. offset	control temp. offset	-100-100℃	0℃
Return water temp. offset	return water temp. offset	-100-100℃	0℃
Mould temp. offset	mould temp. offset	-100-100℃	0℃

Notes: The SV value range varies from different models.

Table 4-6: Time Setting

Parameter	Description	Range	Default
Current time	Current time setting	hr./min./week	No
Reserve the week	Reserve power ON/OFF	ON/OFF	OFF

Table 4-7: One Week ON/OFF Setup

Parameter	Description	Range	Default (start,stop)
Mon.	Reserved ON/OFF time on Mon.	hr/min., hr/min.	01:02, 08:09
Tues.	Reserved ON/OFF time on Tue.	hr/min., hr/min.	02:03, 09:10
Wed.	Reserved ON/OFF time on Wed.	hr/min., hr/min.	03:04, 10:11
Thu.	Reserved ON/OFF time on Thu.	hr/min., hr/min.	04:05, 11:12
Fri.	Reserved ON/OFF time on Fri.	hr/min., hr/min.	05:06, 12:13
Sat.	Reserved ON/OFF time on Sat.	hr/min., hr/min.	06:07, 13:14
Sun.	Reserved ON/OFF time on Sun.	hr/min., hr/min.	07:09, 14:15

Table 4-8: Communication Setup

Parameter	Description	Range	Default
Comm. protocol	comm. protocol	Modbus-RTU	Modbus-RTU
Comm. unit No.	comm. address	1-99	1
Comm. speed	comm. speed	4800、9600、19200	9600
Comm. length	data length	7,8Bit	8Bit
Stop bit	stop bit	1,2Bit	1Bit
Check bit	stop bit	None,odd, even	Even

Table 4-9: Instrument Setup

Parameter	Description	Range	Default
Language	language selection	Chinese/English	Chinese
Far-end setting	far-end setting	use/not use	not use
Password setting	password setting	0-9999	0
Return water and mould temp. display	Return water and mould temp. display	use/not use	not use
DISP	TFT version		
MAIN	control board version		

Table 4-10: Refilling Setup

Parameter	Description	Range	Default
Startup refill time	startup refill time	0-601S	0
Intermittent refill time	intermittent refill time	0-600S	0

4.3.2 Output Setting

4.3.2.1 Main output and auxiliary output of heating control

- 1) When control temp. is smaller than set value, initiate main output and auxiliary output to promptly improve the temp.
- 2) Alternatively select the main output and auxiliary output.

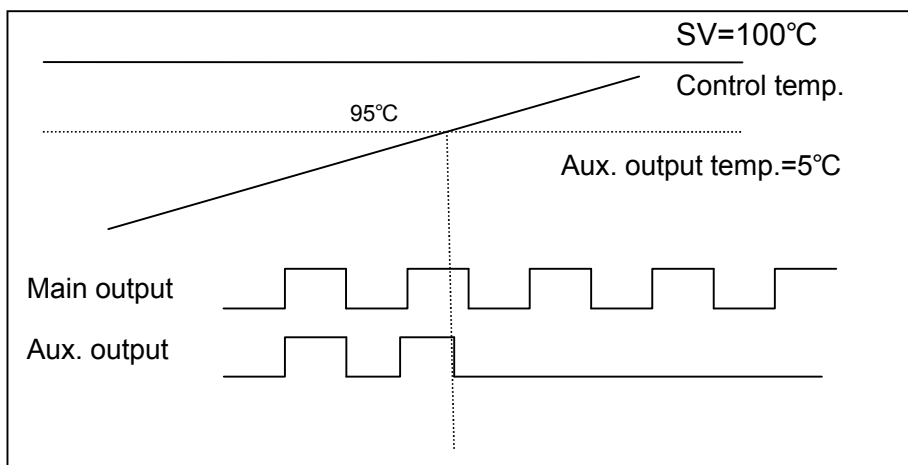

4.3.2.2 Forced cooling

- 1) Press the forced cooling key to stop heating and 100% output the cooling control.
- 2) Control temp. is lower than the cooling temp., automatically dismiss the forced cooling to terminate the control.
- 3) Forced cooling key is available to stop forced cooling for normal control.

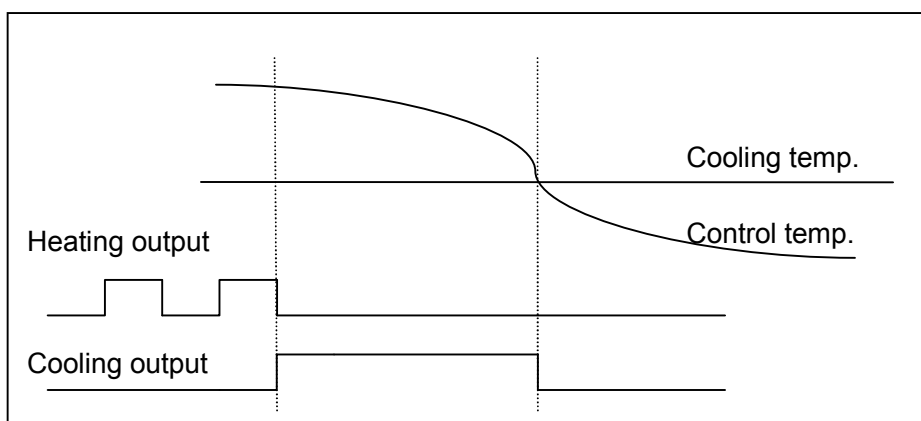

4.3.3 Alarm Settings

4.3.3.1 Disruption alarms

- 1) If the control temp. is kept over the value of disruption alarm for 1 sec., it is considered being interrupted, which will alarm.
- 2) The disruption alarm only works in controls without cooling output.
- 3) Once it sounds alarm, it will keep alarming till BUZZER key is pressed to cancel the alarm.

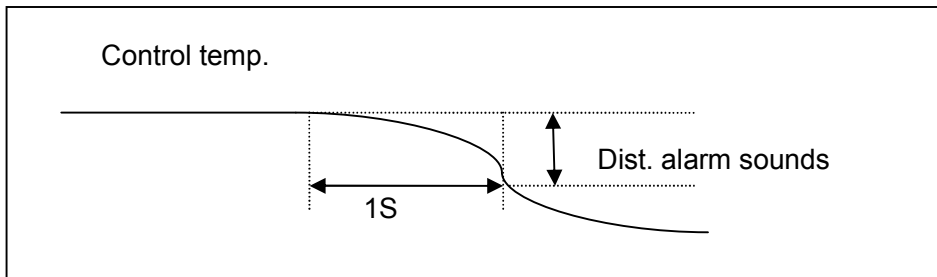

4.3.3.2 Heater Alarm

- 1) In heater alarm setting time, it will alarm when the control temp. can't reach 5°C below the set temp.
- 2) The heater alarm only works in controls, and once it reaches the temp. range, the alarm will be dismissed.
- 3) Even it sounds the alarm, the temp. control is still effective.

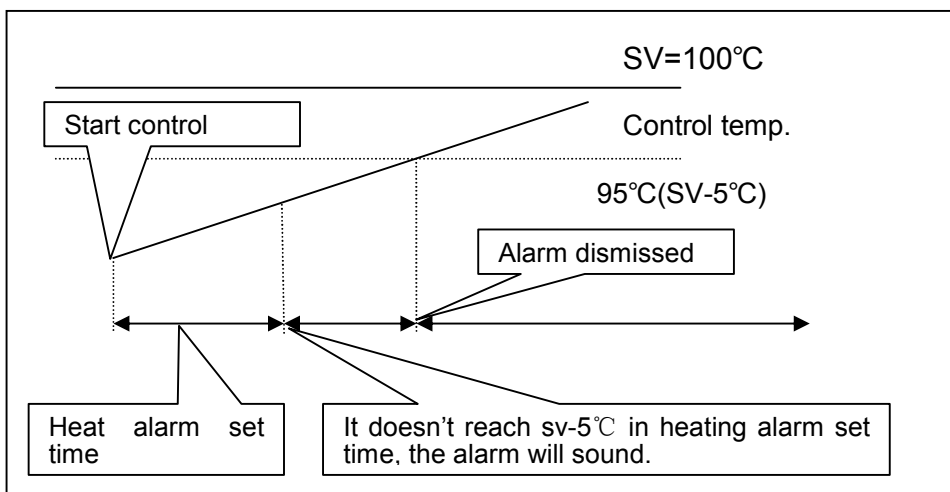

4.3.4 Startup for refilling

- 1) Only after the startup time is set as 60s, and water refilling reaches the high level that the PID starts operation.
- 2) When startup refilling <60S, it will refill according to set time, and the PID will operate.

4.3.5 Auto refilling process

Presss RUN key to refill the water.

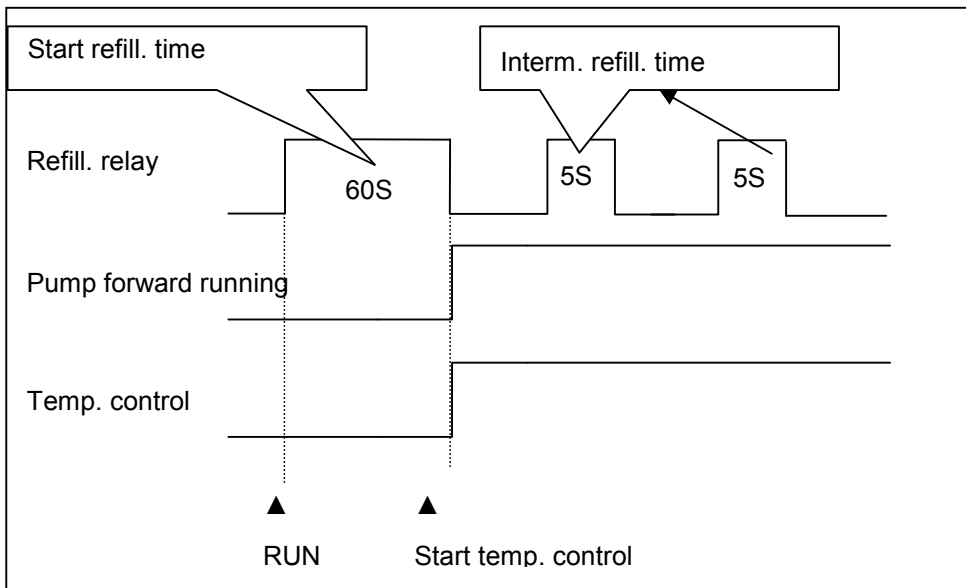

4.4 Errors and Causes

Errors	Causes	Alarm	Temp. control
PCB errors	Regulator error	Occur	Stop
Calibration error	-	Occur	Stop
ADC error	-	Occur	Stop
RJC error	-	Occur	Stop
EEPROM error	-	Occur	State maintain
Phase alarm	Phase shortage or phase reverse detected	Occur	Stop
EGO over temp.	EGO temp. contact input detected	Occur	Stop
Pump overload	Pump overload contact input detected	Occur	Stop
Insufficient pressure	Low pressure contact input detected	Occur	Stop
Overpressure	High pressure contact input detected	Occur	Stop
Low water (liquid) level	Low water (liquid) level contact input detected	Occur	Stop
Temp. window “----“display	Sensor abnormal	Occur	Stop
Water outlet temp. deviation	Control temp. and water outlet temp. deviation	Occur	state maintaining
Return water temp. deviation	Control temp. and return water temp. deviation	Occur	State maintain
Disruption alarm	Control temp. sudden drop	Occur	State maintain
Heater alarm	Control temp. doesn't rise	Occur	State maintain
Over heat	Overheat alarm sounds	Occur	Stop

Notice:

As various alarms above, the controller will activate the protective function as auto shutdown or stop running; please re-press the “operation” to restart.

5. Trouble-shooting

Failures	Possible reasons	Solutions
LCD displays nothing after switch on power and press ON/OFF key.	Did not connect through power supply. Main switch broken. Power supply wires problems. Control circuit fuse melt. Transformer broken.	Connect through power supply. Replace main switch. Check electrical wires. Fix the fuse. Replace the transformer.
Phase alarm.	Power supply low voltage. Phase shortage. Phase reversal. PCB problems.	Check power supply. Check power supply. Exchange two of the wires of power supply. Replace the PCB.
Pump overload.	Abnormal fluctuations of power supply. Pump blocked. Pump motor problems. Overload relay (F1) setting value error.	Check power supply. Check the pump. Check pump motor. Set the setting current of overload relay to equal to 1.1 times of motor rated current. Please refer to Mian Components for detailed description of overload relay. Reset overload relay: Wait for one minute, then press the blue button to reset.
EGO overheats.	EGO temperature setting mistakes. EGO poor temperature detecting. Heater contactor K1 and K2 problems.	Correctly set EGO temperature. (EGO temperature setting value= temperature setting value+10℃) Replace EGO. Replace the contactor.
Low liquid level.	Oil shortage.	Fill high temp. oil.
Temp. window displays ----	Abnormal sensor.	Fill high temp. Oil.
Once running, pump output indicator lightens but pump cannot start. Afetr a while pump still fails to run.	PCB output relay problems. Electrical circuit problems.	Check or replace the PCB. Check electrical circuit.
Differences between setting temperature and actual temperature is too big.	Too short time after machine startup. Temperature parameter setting error. Cooling water valve problems.	Wait for a while. Check temperature parameters. Please refer to the standard manual of setting parameters. Replace solenoid valve.
Temperature can't rise up.	Heater contactor problems. Heater problems. Thermocouple problems. PCB output point problems.	Replace the contactor. Replace pipe heater. Replace thermocouple. Check and repair PCB.

Failures	Possible reasons	Solutions
Circuit breaker tripping off at turning on main switch.	Short circuit of main circuit. Transformer short circuit or connected with earth wire. Problems of circuit breaker.	Check electrical wire. Replace circuit breaker.
Circuit breaker tripping off at turning on pump switch.	Pump motor coil short circuit. Problems of circuit breaker.	Check pump motor. Replace circuit breaker.
Circuit breaker tripping off after short heater output.	Heater tube short circuit or shell contact. Problems of circuit breaker.	Replace heater tube. Replace circuit breaker.

6. Maintenance and Repair

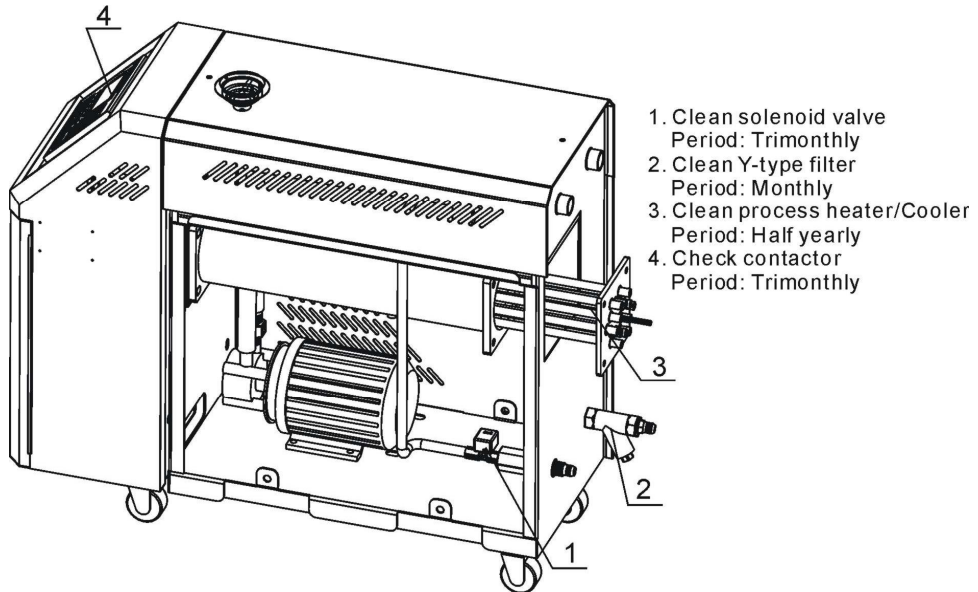

Pay attention to the following rules during maintenance:

- 1) Please reduce the temperature to room temperature (below 50°C), cut off power supply and drain oil and water first while inspecting the machine; carry out operations with safety gloves on after complete confirmation of spaces for inspection and maintenance.
- 2) It is necessary to carry out periodic inspections in order to prolong service life of the system and prevent from safety accidents.

(Please note that it is dangerous to check or tear down the machine during operation.)

6.1 Open the Covers

- 1) Open the top covers of the unit. (Refer to the pictures below)



Picture 6-1: Open the Covers 1

- 2) Take down the side covers. (Refer to the pictures below)

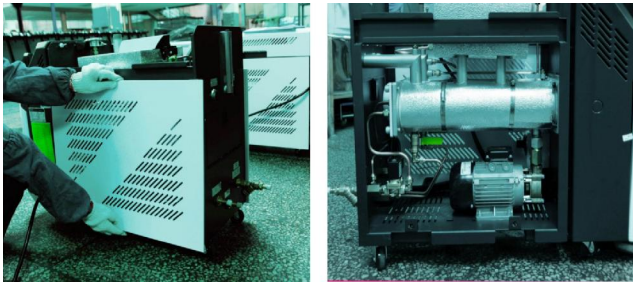

Picture 6-2: Open the Covers 2

- 3) Open the cover of control box. Screw off two butterfly screws to unlock the cover. (Refer to the pictures below)

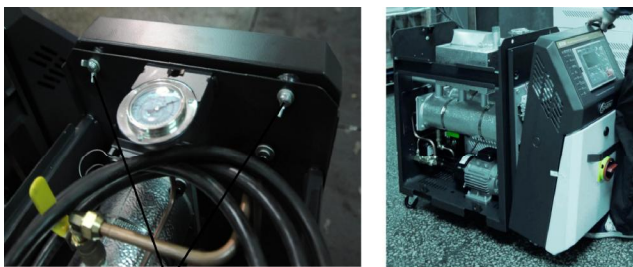

Butterfly screws

Picture 6-3: Open the Covers 3

6.2 Y Type Strainer

- 1) Clean soft water should be used as cooling water. Filter screen is used in the strainer to stop impurities and pollutants to enter into water pipe.
- 2) Impurities or pollutants may cause errors and bad temperature control. Clean filter screen of the strainer periodically.
- 3) Cleaning steps: turn off power and cooling water supply. Open the top cover of filter screen to clean the filter.



Picture 6-4: Y Type Strainer

6.3 Solenoid Valve

Replace solenoid valve:

- 1) Open machine top cover.
- 2) Take down right side cover.
- 3) Unfix the solenoid valve for replacement.
- 4) Install the covers in a reverse order.



Solenoid valve

Picture 6-5: Solenoid Valve

6.4 Pipe Heater

- 1) Open machine rear cover door. (Refer to pictures below)



Picture 6-6: Pipe Heater 1

- 2) Unlock the screws of pipe heater to take it out. (Refer to the pictures below.)

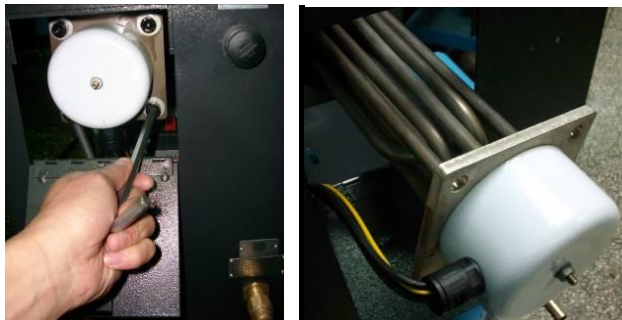

Picture 6-7: Pipe Heater 2

- 3) After the cleaning, install the pipe heater to the machine according to above opposite orders.

6.5 By-pass Globe Valve

Shut off the by-pass globe valve when water pressure gauge display value is too low.



Picture 6-8: By-pass Globe Valve

6.6 Printed Circuit Board

MAIN terminal board drawing (refer to next page for terminal position and number).

① SENSOR TERMINAL1 (sensor terminal)

2, 3 : control temp. sensor terminal

5, 6 : return water temp. sensor terminal

8, 9 : water out temp. sensor terminal

11, 12 : 1~5V input terminal

② DI TERMINAL (contactor input terminal)

13, 14 : pump overload contactor input terminal

15, 16 : EGO overheat contactor input terminal

17, 18 : underpressure contactor input terminal

19, 20 : overpressure contactor input terminal

21, 22 : lower water limit contactor input terminal

23, 24 : upper water limit contactor input terminal

③ OUTPUT TERMINAL (output terminal for controlling)

1, 2 : heating control output MAIN (RELAY output)

3, 4 : heating control output SUB (RELAY output)

5, 6 : cooling control output (RELAY output)

④ DO TERMINAL (relay contactor output terminal)

1, 2 : pump running contactor output terminal

3, 4 : pump inverse running contactor output terminal

5, 6 : backup water contactor output terminal

7, 8 : SUCTION contactor output terminal

9, 10 : alarm contactor output terminal

11, 12 : relay contactor output terminal

13, 14 : reserve

⑤ PHASE CHECK TERMINAL (phase detect terminal)

1 : R phase connect terminal

2 : S phase connect terminal

3 : T phase connect terminal

⑥ DISPLAY CN (connect terminal for display)

Connect stub cable with STM100.

⑦ POWER TERMINAL (power supply terminal)

1 : FG terminal

2, 3 : power supply terminal (100~240VAC)

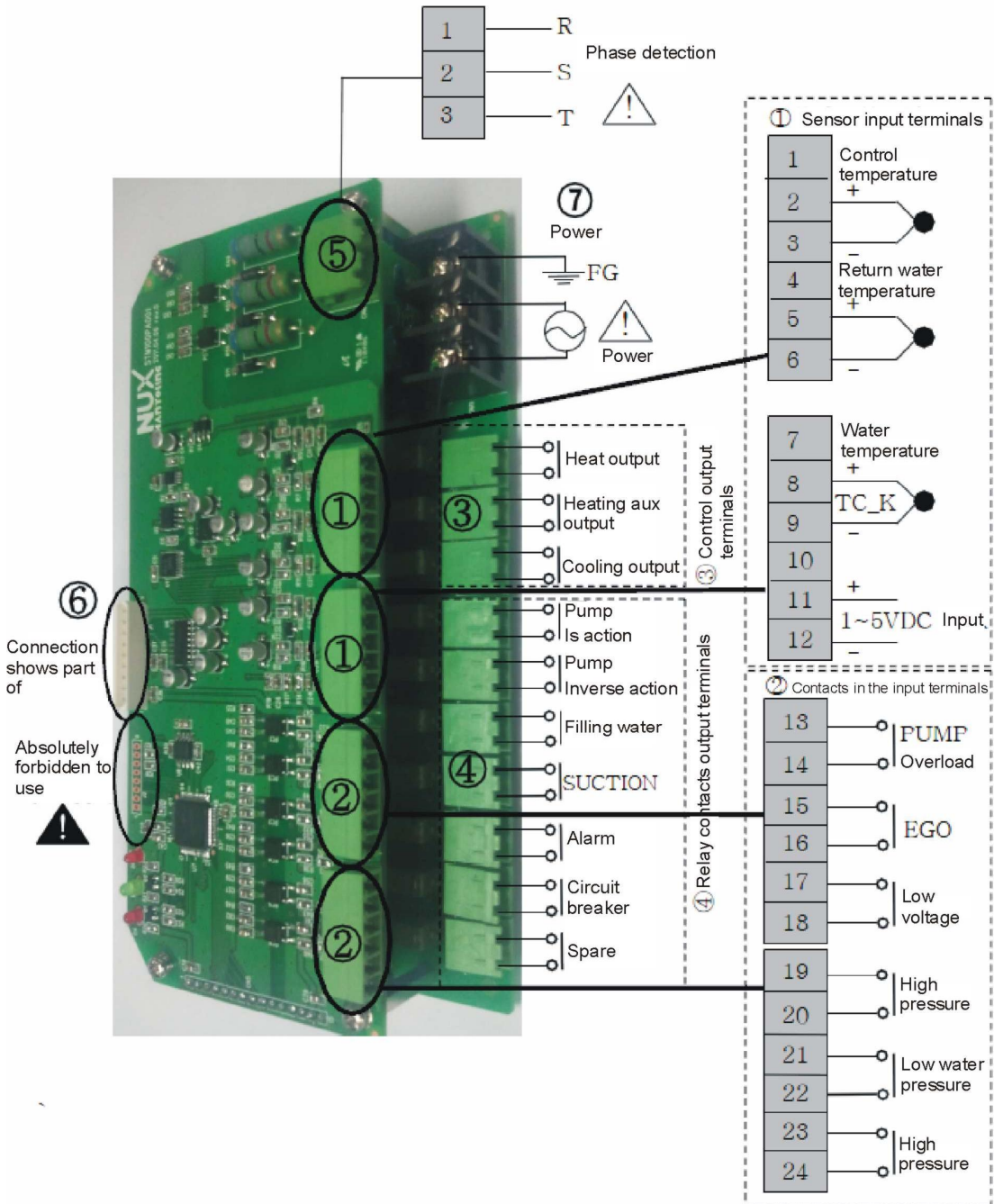

6.7 Displayer Terminal Connecting Diagram

① DI TERMINAL

1, 2: Run/stop di terminal

② COMM TERMINAL

1, 2, 3, 4: rs485 Comm terminal

5: Earth terminal

③ MAIN CN

Connet to the electric cables which also connected with stm100

④ TEST PIN

Test pin No connection

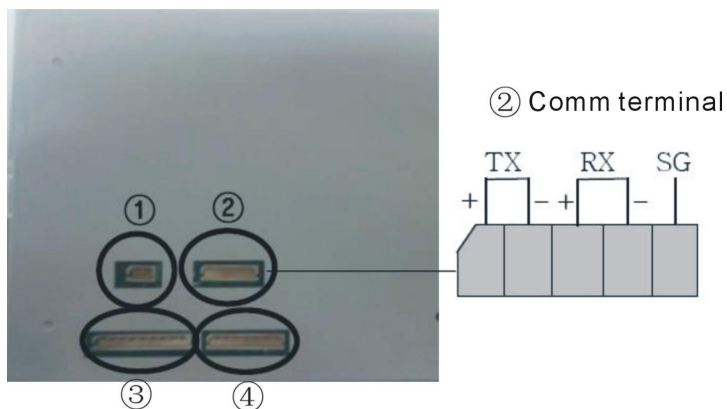

6.8 Maintenance Schedule

6.8.1 About the Machine

Model _____ SN _____ Manufacture date _____

Voltage _____ Φ _____ V Frequency _____ Hz Power _____ kW

6.8.2 Installation & Inspection

- Check the installation space is enough as required.
- Check the pipes are correctly connected.

Electrical installation

- Voltage: _____ V _____ Hz
- Fuse melting current: 1 Phase _____ A 3 Phase _____ A
- Check phase sequence of power supply.

6.8.3 Daily Checking

- Check machine startup function.
- Check all the electrical wires.

6.8.4 Weekly Checking

- Check loose electrical connections.
- Check and clean Y type filter ¹.
- Check solenoid valve.
- Check motor overload and phase reversal alarm function.
- Check whether pipeline joints are under looseness.
- Check the sensitivity of EGO.

6.8.5 Trimonthly Checking

- Check level switch.
- Check the contactor ².
- Replace the hot kerosene with a using temperature above 160 degree ³.

6.8.6 Half-yearly Checking

- Check damaged pipes.
- Clean process heater/cooler.
- Check indicator and buzzer.

- Replace the hot kerosene with a using temperature above 120~160 degree ⁴.

6.8.7 Yearly Checking

- Replace the hot kerosene with a using temperature above 120 degree ⁵.

6.8.8 3 year Checking

- PC board renewal.
- No fuse breaker renewal.

- Note: 1. Y-type filter has the function of filling water cooling protection effect, be sure the waterway are clear to avoid cooling failure.
2. Manufacturer laboratory data for AC contactor is two million times in life. we suggest service life for one million four hundred thousand times, if work eight hours per day, recommended replacing frequency is 1.5 years, if work day and night, replacement is suggested to be done every six months.
3. Hot kerosene coke will influence the detection accuracy of internal temperature probe and the efficiency of heat elements, three months replacing frequency is suggested.
4. Hot kerosene coke will influence the detection accuracy of internal temperature probe and the efficiency of heat elements, six months replacing frequency is suggested.
5. Hot kerosene coke will influence the detection accuracy of internal temperature probe and the efficiency of heat elements, suggested replacing frequency is one year.