

整机版本 Ver.D

制图		版号		标题		图号		比例		第 1 张	
设计	E	核	E	SCD-20U(4.0U)/30H-OP		SCD-20U(4.0U)/30H-OP-PUMP-CE-400V-E-1		标准	CE	共	6 张
校对		准		主电路图一				机	机	4	00V
审核		日期	20170620	SHINI		信易塑料机械股份有限公司 Shini Plastics Technologies, Inc.		器	器	5	0Hz
更改前	更改后	更改人	日期	1	2	3	4	5	6	7	8

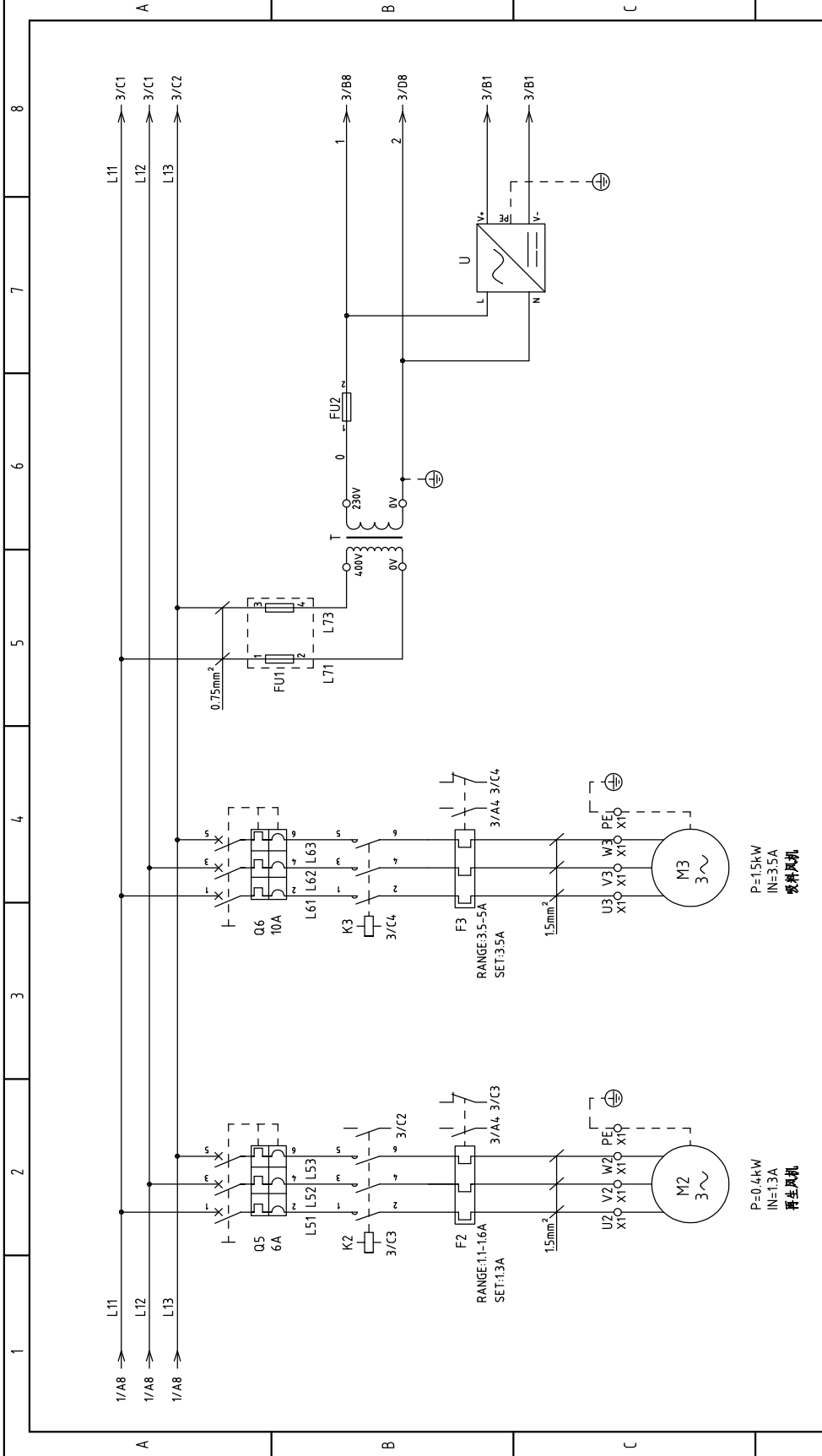

整机版本 Ver.D

制图	版号	E	标题	SCD-20U(4.0U)/30H-OP	图号	SCD-20U(4.0U)/30H-OP-PUMP-CE-4.00V-E-2	比例	第 2 张
设计	核 准		主电路图二				标准	共 6 张
校对	日期	20170620	SHINI 信易塑料机械股份有限公司 Shini Plastics Technologies, Inc.				机师电压	4.00V
审核	日期						机师频率	50Hz

邦普K.SF878500A.01-01(三机一体)

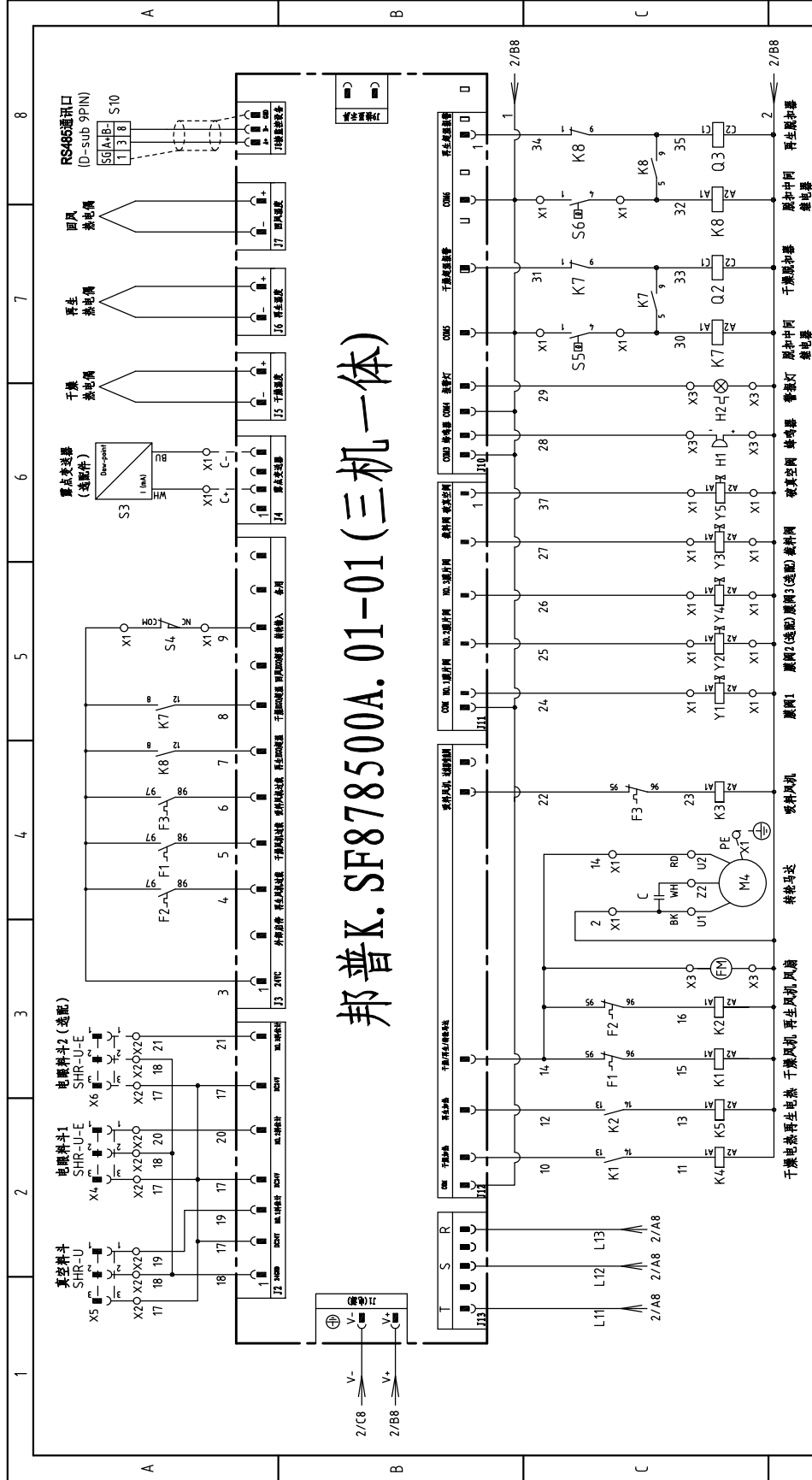

整机版本 Ver.D

注: 改适配时, 25, 26号线也改为24号接入膜阀1

图号	SCD-200I(4.0U)/30H-OP	比例	第 3 张
标题	控制电路图	标准	共 6 张
图号	SCD-200I(4.0U)/30H-OP-PUMP-CE-4.00V-E-3	机器电压	4.00V
图号	信易塑料机械股份有限公司 Shini Plastics Technologies, Inc.	机器频率	50Hz



制图	版号	E	日期	20170620
设计	核准			
校对	更改人		日期	
审核	更改后			

1	2	3	4	5	6	7	8
序号/NO	符号/Symbol	名称/Name	制造商/Manufacturer	型号/Type	规格/Specification	数量/Number	物料编号/Material number
1	Q1	主电源开关/Main power switch	EATON	P1-25/EA/SVB	25A	1	YE10125250000
2	Q2,Q3,Q6	断路器/Circuit-breaker	TECO	BM-63C 3P	10A	3	YE40301003000
3		励磁脱扣器/Excitation release	TECO	MX	220V 50/60Hz	2	YE40023560000
4	Q4,Q5	断路器/Circuit-breaker	TECO	BM-63C 3P	6A	2	YE40300603000
5	K1,K2,K3	接触器/Contactor	SIEMENS	3RT6016-1AN21	220V 50/60Hz	3	YE00601621000
6	K4	接触器/Contactor	SIEMENS	3RT6017-1AN21	220V 50/60Hz	1	YE00601721000
7	K5	接触器/Contactor	SIEMENS	3RT6017-1AN21	220V 50/60Hz	1	YE00601721000
8	K7,K8	中间继电器/Middle relay	WEIDMULLER	DRM270730LT	220V 50/60Hz	2	YE03270700000
9	F1	热过载继电器/Overload relay	SIEMENS	3RU6116-1AB0	1.1-1.6A	1	YE01160110000
10	F2	热过载继电器/Overload relay	SIEMENS	3RU6116-1AB0	1.1-1.6A	1	YE01160110000
11	F3	热过载继电器/Overload relay	SIEMENS	3RU6116-1FB0	3.5-5A	1	YE01160350000
12	PCB	微电脑控制板-微电脑显示屏	PUMP	K.SF878500A.01-01	-----	1	YE80878500000
13	T	变压器/Transformer	BAIYUN	BY-0407009	IN=400V OUT=230V 500mA	1	YE70402300800
14	U	直流电源/DC power	MEAN WELL	NES-35-24	OUT=DC24V 1.5A	1	YE71352400100
15	FU1	熔断器座/Fuse base	CHINT	RT18-32	2P	1	YE41032200000
16	FU2	熔断器/Fuse	CHINT	10*38 500V	2A	2	YE46002000100
17	FU2	熔断器/Fuse	YINDA	FS-10	2A	1	YE41001000000
18	S1	磁簧开关/Reed switch	FOTEK	FC-12V	24VDC	1	YE15001200000
19	S2	光电开关/Photoelectric switch	FOTEK	T18-3MNB-PE	24VDC	1	YE15143900000
20	S3	零点变送器/Dew-point transducer	CS	CS 217-OEM	POWER=24VDC OUT=4-20mA	1	YE90021700100
21	S4	微动开关/Micro switch	TEND	LXW5-11G1	250V 5(4)A	1	-----
22	S5,S6	温度保护器/Temperature protector	EGO	WR-A-50-300-2500-3	250V 5(4)A	2	-----
23	S7,S8,S9	热电阻/Thermocouple	SHINI	ST-K	K	3	-----
24	Y1,Y2	电磁阀/Solenoid valve	FESTO	MSFW-230-50/60	220V 50/60Hz	2	-----
25	H1	蜂鸣器/Buzzer	HITPOINT	PK-35A	220V	1	YE84003500200
整机版本Ver.D							
注: (1)表示非电控箱内材料; (2)表示选配件							
制图			版号		图号		第 5 张
设计			E		SCD-200I(4.0U)/30H-OP		共 6 张
校对			核 准		SCD-200I(4.0U)/30H-OP-PUMP-CE-4.00V-E-5		CE
审核			日期		电气元件明细表一		机器电压
更改后			更改人		SHINI		4.00V
更改前			日期		信易塑料机械股份有限公司 Shini Plastics Technologies, Inc.		50Hz
1			4		6		8
2			5		7		



1	2	3	4	5	6	7	8	
序号/NO	符号/Symbol	名称/Name	制造商/Manufacturer	型号/Type	规格/Specification	数量/Number	物料编号/Material number	备注/Remark
26	H2	警报指示灯/Alarm indicator	SHINI	LED-3051	220V 50/60Hz	1	YE83305100200	(1)
27	X1	端子排/Terminal board	HONEYWELL	4mm ²	41A 690V	18	YE60000403200	
28				4mm ² PE	-	6	YE60000403500	A
29				2.5mm ²	32A 690V	14	YE60002503200	
30				2.5mm ² PE	-	4	YE60002503400	
31				2.5mm ²	32A 690V	6	YE60002503200	(2)
32				2.5mm ² PE	-	2	YE60002503400	(2)
33	X2	端子排/Terminal board	----	三层弹簧端子SK2.5-TL	10A 250V	3	YE60002503600	
34				FBSTB 10-ZDIK RD	10A 250V	3	YE60001000200	
35				SK-2.5TL桥接件	10A 250V	3	YE60001003600	
36	X3	端子排/Terminal board	HONEYWELL	2.5mm ²	32A 690V	5	YE60002503200	B
37				2.5mm ² PE	-	1	YE60002503400	
38	X4, X5	重载连接器/Heavy duty connector	SIBAS	HDC-HA-004.1	4P 10A	2	YE68041000100	(1)
39	FM	风扇/Fan	SUNON	DP-200A	230VAC 40W	1	YM60121200400	(1)
40	M1	风机/Blower	SHINI	-----	400V 0.4kW	1	-----	(1)
41	M2	风机/Blower	SHINI	-----	400V 0.4kW	1	-----	(1)
42	M3	风机/Blower	SHINI	-----	400V 1.5kW	1	-----	(1)
43	M4	马达/Motor	----	-----	230V 0.015kW	1	-----	(1)
44	EH1	电热器/Heater	SHINI	-----	400V 3kW	1	-----	(1)
45	EH2	电热器/Heater	SHINI	-----	400V 3kW	1	-----	(1)
46	S10	通信接口板RS-485 (雙Daub-9pin接頭)	--	--	--	1	YE90048501200	(1)
47		外觀RS485 (SIL-700G-A-19) 0版	--	--	--	1	YR40048500000	(1)
48								
49								
50								
整机版本 Ver.D								D
注: (1)表示非电控箱内材料; (2)表示选配件								
制图			版号		图号		比例	
设计			E		SCD-20U(4.0U)/30H-OP		标准	
校对			核 准		电气元件明细表二		CE	
日期			20170620		SHINI		机器电压	
更改人					信易電熱機械股份有限公司		4.00V	
更改后					Shini Plastics Technologies, Inc.		机器频率	
更改前							5.0Hz	
1	2	3	4	5	6	7	8	

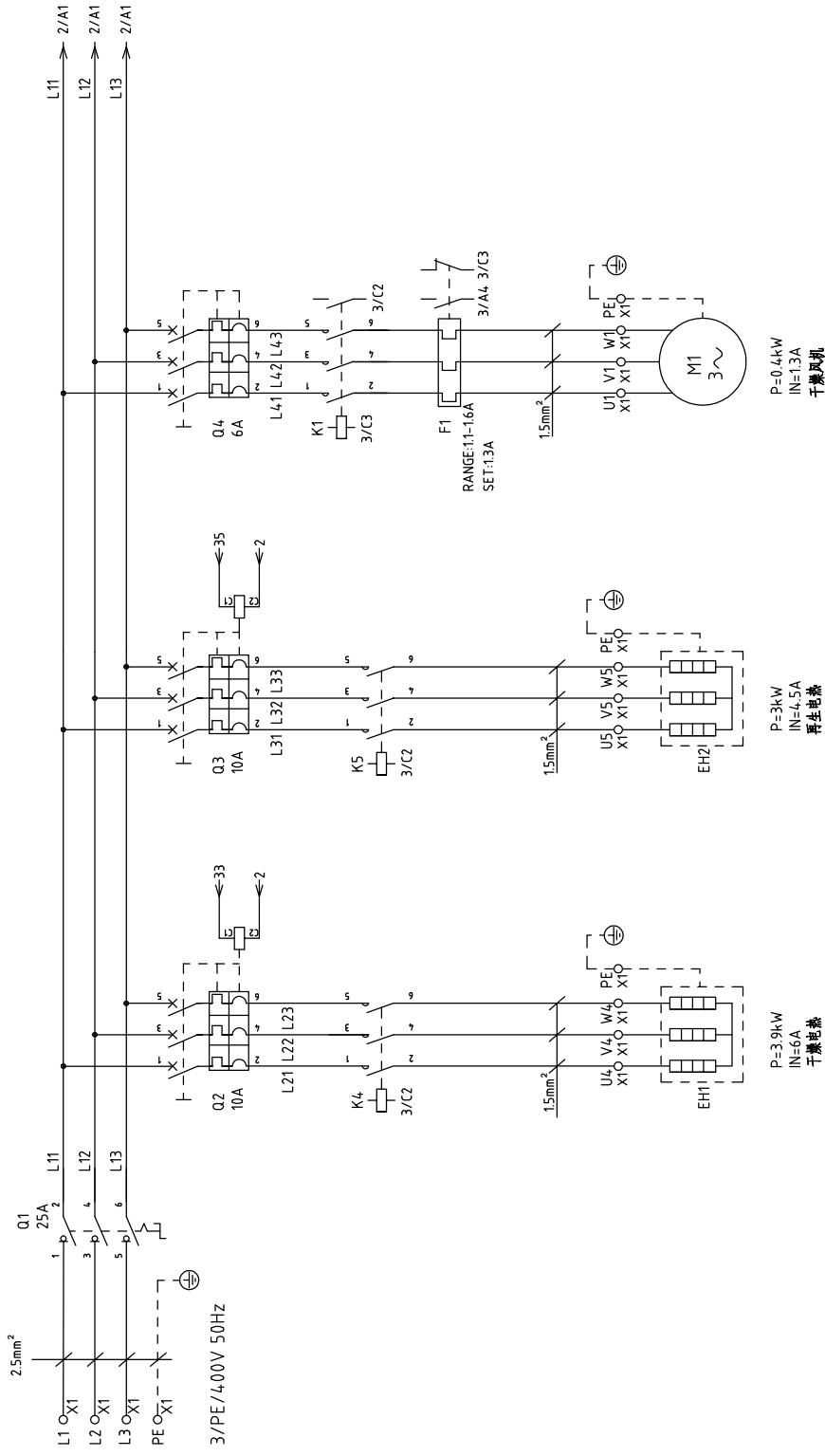

整机版本 Ver.D

制图	版号	图号	比例	第 1 张
设计	核 准	SCD-80U/50H-0P 主电路图一	标准	共 6 张
校对	日期	SCD-80U/50H-OP-PUNP-CE-400V-E-1	机器电压	400V
审核	日期	信易塑料机械股份有限公司 Shini Plastics Technologies, Inc.	机器频率	50Hz
更改后	更改人			
更改前	更改日期			

1

2

3

4

5

6

7

8

8

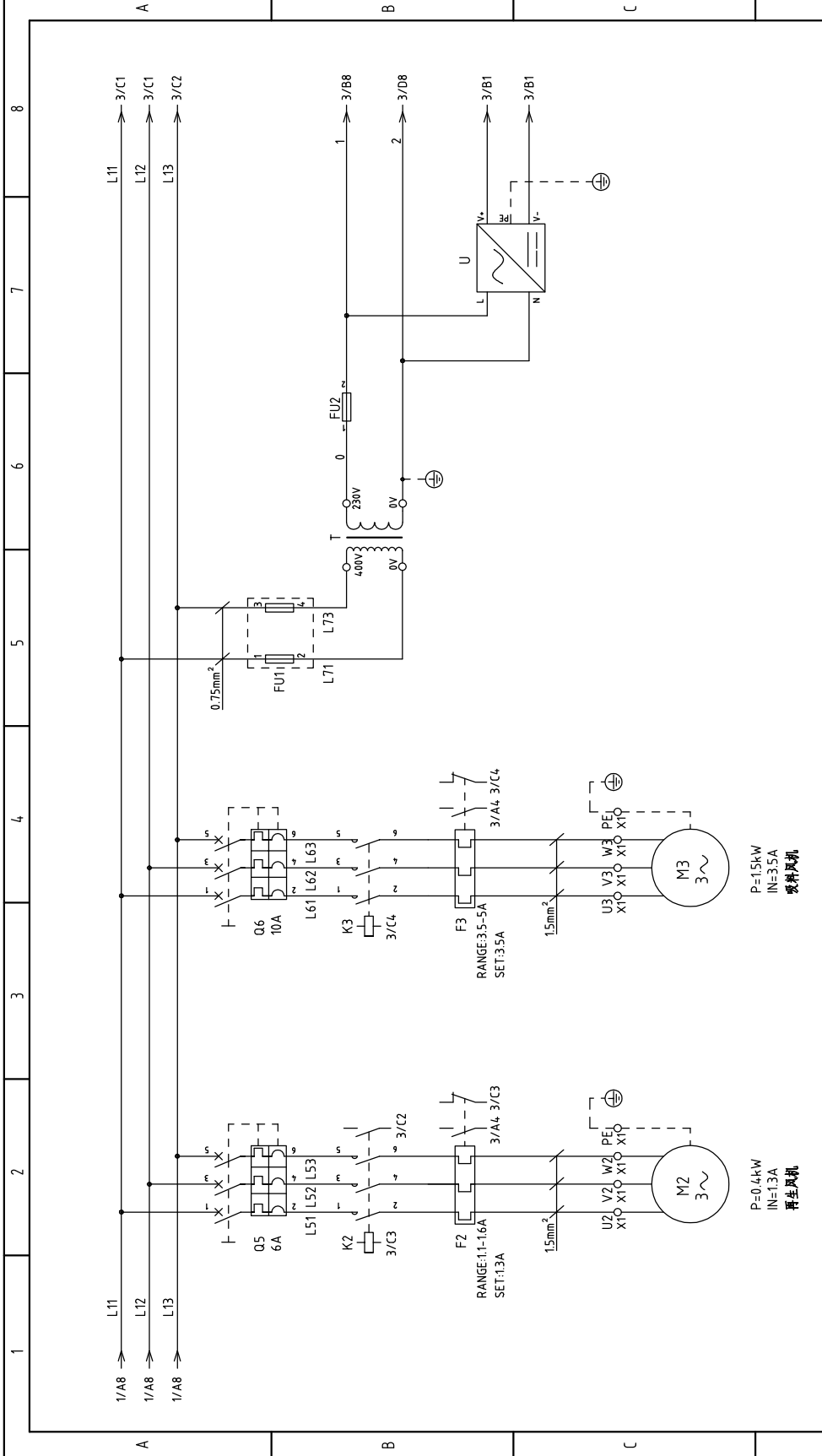

整机版本 Ver.D

制图	版号	标题	图号	比例	第 2 张
设计	核 准	SCD-80U/50H-OP 主电路图二	SCD-80U/50H-OP-PUNP-CE-400V-E-2	标准	共 6 张
校对	日期	 信易塑料机械股份有限公司 Shini Plastics Technologies, Inc.	信易 Shini Plastics Technologies, Inc.	机器电压	400V
审核	日期			机器频率	50Hz
更改前	更改后	更改人	更改日期	20170620	8

邦普K.SF878500A.01-01(三机一体)

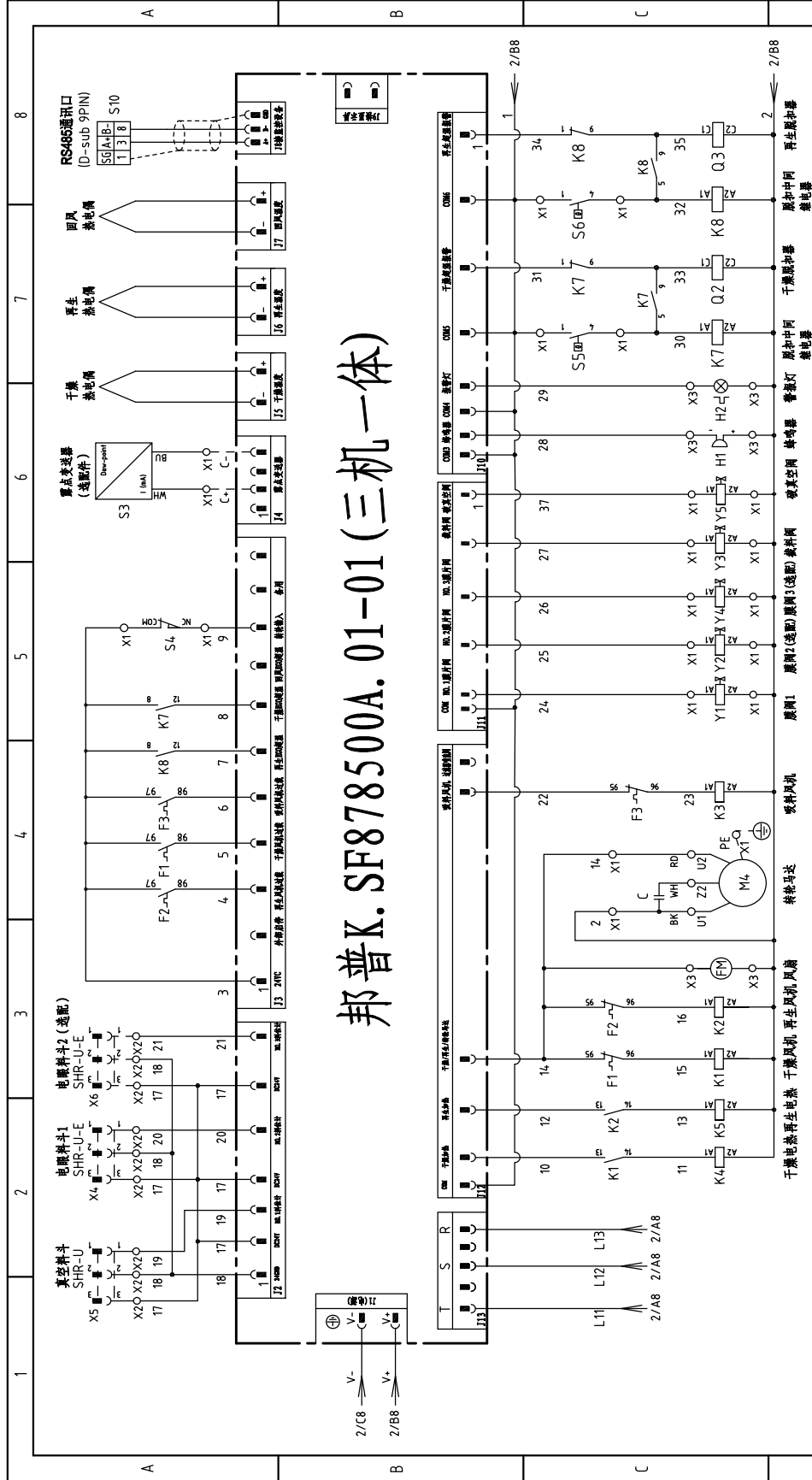

整机版本 Ver.D

注: 改适配时, 25, 26号线也改为24号接入膜阀1

图号	SCD-80U/50H-OP	图号	SCD-80U/50H-OP-PUMP-CE-4.00V-E-3
标题	控制电路图	比例	CE
版号	E	标准	机器电压
核	准	机器频率	4.00V
日期	20170620	机器频率	50Hz



信易塑料机械股份有限公司
Shini Plastics Technologies, Inc.

第 3 张	共 6 张
-------	-------

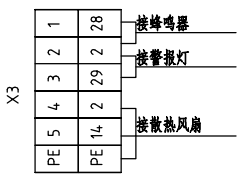
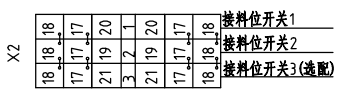
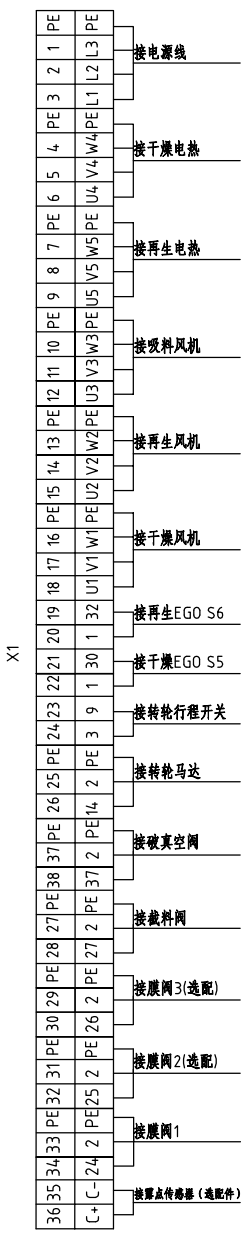
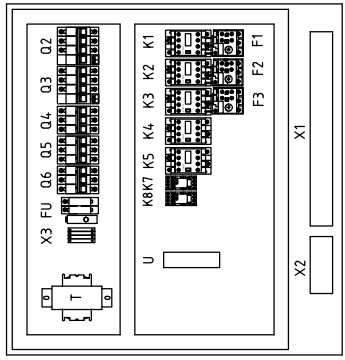
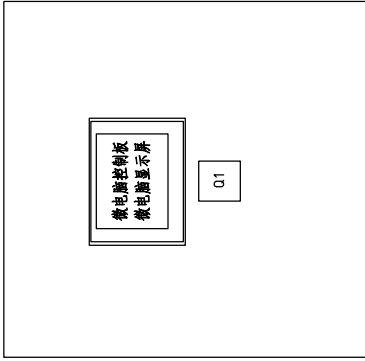
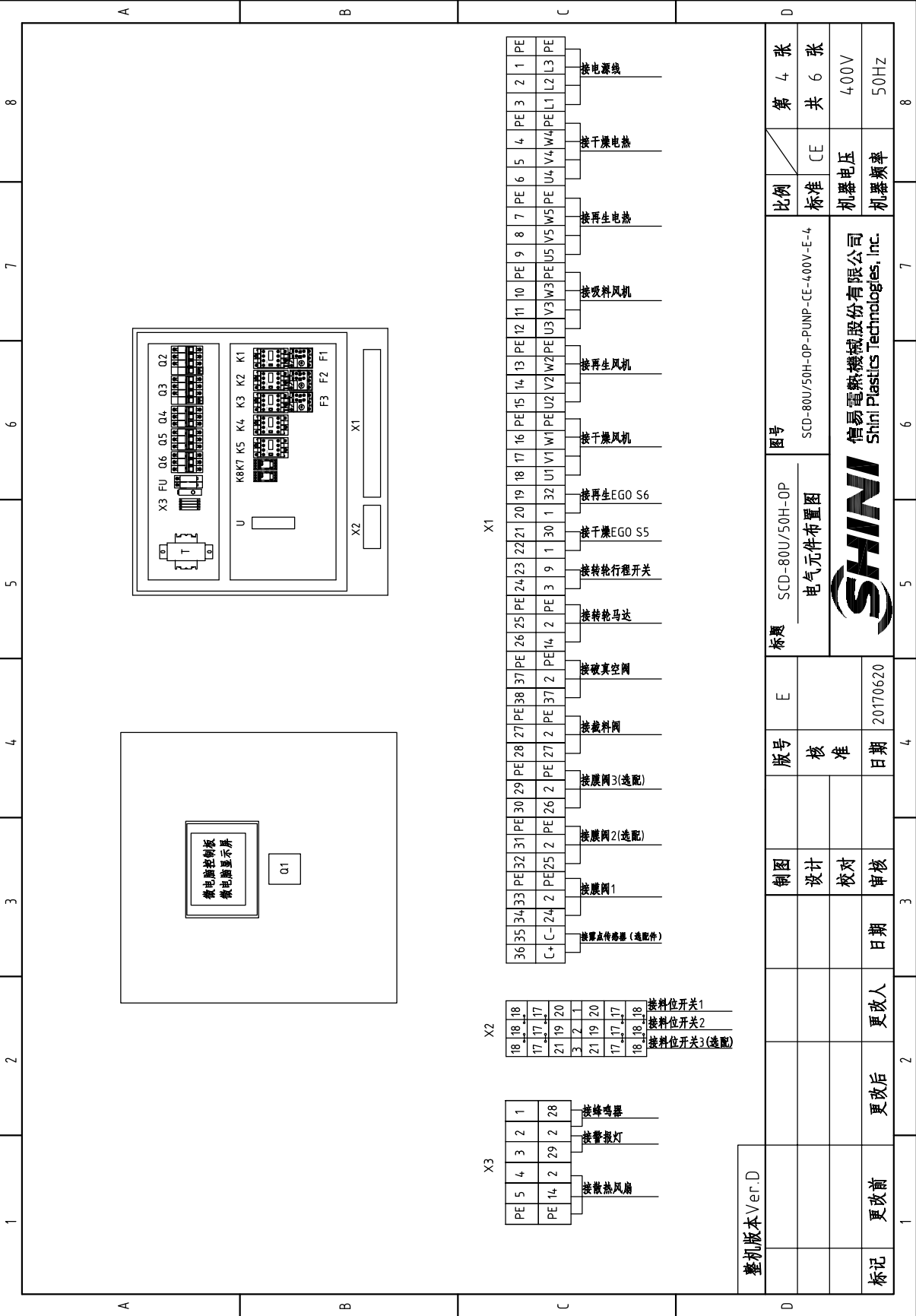

整机版本	Ver.D
------	-------

标题	SCD-80U/50H-OP 电气元件布置图	图号	SCD-80U/50H-OP-PUNP-CE-4.00V-E-4	比例	第 4 张 共 6 张
版号	E	制图	设计	标准	CE
核准	日期	校对	审核	机器电压	4.00V
日期	20170620	更改人	更改后	机器频率	50Hz
日期		更改后	更改前		



信易塑料机械股份有限公司
Shini Plastics Technologies, Inc.

1	2	3	4	5	6	7	8	
序号/NO	符号/Symbol	名称/Name	制造商/Manufacturer	型号/Type	规格/Specification	数量/Number	物料编号/Material number	
1	Q1	主电源开关/Main power switch	EATON	P1-25/EA/SVB	25A	1	YE10I25250000	
2	Q2,Q3,Q6	断路器/Circuit-breaker	TECO	BM-63C 3P	10A	3	YE40301003000	
3		励磁保护器/Excitation release	TECO	MX	220V 50/60Hz	2	YE40023560000	
4	Q4,Q5	断路器/Circuit-breaker	TECO	BM-63C 3P	6A	2	YE40300603000	
5	K1,K2,K3	接触器/Contactor	SIEMENS	3RT6016-1AN21	220V 50/60Hz	3	YE00601621000	
6	K4	接触器/Contactor	SIEMENS	3RT6017-1AN21	220V 50/60Hz	1	YE00601721000	
7	K5	接触器/Contactor	SIEMENS	3RT6017-1AN21	220V 50/60Hz	1	YE00601721000	
8	K7,K8	中间继电器/Middle relay	WEIDMULLER	DRM270730LT	220V 50/60Hz	2	YE03270700000	
9	F1	热过载继电器/Overload relay	SIEMENS	3RU6116-1AB0	1.1-1.6A	1	YE01160110000	
10	F2	热过载继电器/Overload relay	SIEMENS	3RU6116-1AB0	1.1-1.6A	1	YE01160110000	
11	F3	热过载继电器/Overload relay	SIEMENS	3RU6116-1FB0	3.5-5A	1	YE01160350000	
12	PCB	微电脑控制板-微电脑显示屏	PUMP	K.SF878500A.01-01	-----	1	YE80878500000	
13	T	变压器/Transformer	BAIYUN	BY-0407009	IN=400V OUT=230V 500mA	1	YE70402300800	
14	U	直流电源/DC power	MEAN WELL	NES-35-24	OUT=DC24V 1.5A	1	YE71352400100	
15	FU1	熔断器座/Fuse base	CHINT	RT18-32	2P	1	YE41032200000	
16	FU2	熔断器/Fuse	CHINT	10*38 500V	2A	2	YE46002000100	
17	FU2	熔断器/Fuse	YINDA	FS-10	2A	1	YE41001000000	
18	S1	磁簧开关/Reed switch	FOTEK	FC-12V	24VDC	1	YE15001200000	
19	S2	光电开关/Photoelectric switch	FOTEK	T18-3MNB-PE	24VDC	1	YE15143900000	
20	S3	霍尔变送器/Dew-point transducer	CS	CS 217-OEM	POWER=24VDC OUT=4-20mA	1	YE90021700100	
21	S4	微动开关/Micro switch	TEND	LXW5-11G1	250V 5(4)A	1	-----	
22	S5,S6	温度保护器/Temperature protector	EGO	WR-A-50-300-2500-3	250V 5(4)A	2	-----	
23	S7,S8,S9	热电阻/Thermocouple	SHINI	ST-K	K	3	-----	
24	Y1,Y2	电磁阀/Solenoid valve	FESTO	MSFW-230-50/60	220V 50/60Hz	2	-----	
25	H1	蜂鸣器/Buzzer	HITPOINT	PK-35A	220V	1	YE84003500200	
A								
B								
C								
D								
整机版本 Ver.D								
注: (1)表示非电控箱内材料; (2)表示选配件								
制图			版号		标题		图号	
设计			E		SCD-80U/50H-0P		SCD-80U/50H-0P-PUMP-CE-4.00V-E-5	
校对			核准		电气元件明细表一		比例	
日期			日期		20170620		标准	
更改后			更改人		日期		CE	
更改前			更改后		日期		机器电压	
							4.00V	
							机器频率	
							50Hz	
							第 5 张	
							共 6 张	
							4.00V	
							50Hz	
							第 5 张	
							共 6 张	
							4.00V	
							50Hz	
							第 5 张	
							共 6 张	
							4.00V	
							50Hz	
							第 5 张	
							共 6 张	
							4.00V	
							50Hz	
							第 5 张	
							共 6 张	
							4.00V	
							50Hz	
							第 5 张	
							共 6 张	
							4.00V	
							50Hz	
							第 5 张	
							共 6 张	
							4.00V	
							50Hz	
							第 5 张	
							共 6 张	
							4.00V	
							50Hz	
							第 5 张	
							共 6 张	
							4.00V	
							50Hz	
							第 5 张	
							共 6 张	
							4.00V	
							50Hz	
							第 5 张	
							共 6 张	
							4.00V	
							50Hz	
							第 5 张	
							共 6 张	
							4.00V	
							50Hz	
							第 5 张	
							共 6 张	
							4.00V	
							50Hz	
							第 5 张	
							共 6 张	
							4.00V	
							50Hz	
							第 5 张	
							共 6 张	
							4.00V	
							50Hz	
							第 5 张	
							共 6 张	
							4.00V	
							50Hz	
							第 5 张	
							共 6 张	
							4.00V	
							50Hz	
							第 5 张	
							共 6 张	
							4.00V	
							50Hz	
							第 5 张	
							共 6 张	
							4.00V	
							50Hz	
							第 5 张	
							共 6 张	
							4.00V	
							50Hz	
							第 5 张	
							共 6 张	
							4.00V	
							50Hz	
							第 5 张	
							共 6 张	
							4.00V	
							50Hz	
							第 5 张	
							共 6 张	
							4.00V	
							50Hz	
							第 5 张	
							共 6 张	
							4.00V	
							50Hz	
							第 5 张	
							共 6 张	
							4.00V	
							50Hz	
							第 5 张	
							共 6 张	
							4.00V	
							50Hz	
							第 5 张	
							共 6 张	
							4.00V	
							50Hz	
							第 5 张	
							共 6 张	
							4.00V	
							50Hz	
							第 5 张	
							共 6 张	
							4.00V	
							50Hz	
							第 5 张	
							共 6 张	
							4.00V	
							50Hz	
							第 5 张	
							共 6 张	
							4.00V	
							50Hz	
							第 5 张	
							共 6 张	
							4.00V	
							50Hz	
							第 5 张	
							共 6 张	
							4.00V	
							50Hz	
							第 5 张	
							共 6 张	
							4.00V	
							50Hz	
							第 5 张	
							共 6 张	
							4.00V	
							50Hz	
							第 5 张	
							共 6 张	
							4.00V	
							50Hz	
							第 5 张	
							共 6 张	
							4.00V	
							50Hz	
							第 5 张	
							共 6 张	
							4.00V	
							50Hz	
							第 5 张	
							共 6 张	
							4.00V	
							50Hz	
							第 5 张	
							共 6 张	
							4.00V	
							50Hz	
							第 5 张	
							共 6 张	
							4.00V	
							50Hz	
							第 5 张	
							共 6 张	
							4.00V	
							50Hz	
							第 5 张	
							共 6 张	
							4.00V	
							50Hz	
							第 5 张	
							共 6 张	
							4.00V	
							50Hz	
							第 5 张	
							共 6 张	
							4.00V	
							50Hz	
							第 5 张	
							共 6 张	
							4.00V	
							50Hz	
							第 5 张	
							共 6 张	
							4.00V	
							50Hz	
							第 5 张	
							共 6 张	
							4.00V	
							50Hz	
							第 5 张	
							共 6 张	
							4.00V	
							50Hz	
							第 5 张	
							共 6 张	
							4.00V	
							50Hz	
							第 5 张	
							共 6 张	
							4.00V	
							50Hz	
							第 5 张	
							共 6 张	
							4.00V	
							50Hz	

1	2	3	4	5	6	7	8
序号/NO	符号/Symbol	名称/Name	制造商/Manufacturer	型号/Type	规格/Specification	数量/Number	物料编号/Material number
26	H2	警报指示灯/Alarm indicator	SHINI	LED-3051	220V 50/60Hz	1	YE83305100200
27	T	变压器/Transformer	BAIYUN	BY-0407009	IN=400V OUT=230V/18V 500mA	1	YE70504-0000000
28	X1	端子排/Terminal board	HONEYWELL	4mm ²	41A 690V	18	YE60000403200
29				4mm ² PE	-	6	YE60000403500
30				2.5mm ²	32A 690V	14	YE60002503200
31				2.5mm ² PE	-	4	YE60002503400
32				2.5mm ²	32A 690V	6	YE60002503200
33				2.5mm ² PE	-	2	YE60002503400
34	X2	端子排/Terminal board	----	三层弹簧端子SK2.5-TL	10A 250V	3	YE60002503600
35				FBSTB 10-ZDIK RD	10A 250V	3	YE60001000200
36				SK-2.5TL桥接件	10A 250V	3	YE60001003600
37	X3	端子排/Terminal board	HONEYWELL	2.5mm ²	32A 690V	5	YE60002503200
38				2.5mm ² PE	-	1	YE60002503400
39	X4,X5	重载连接器/Heavy duty connector	SIBAS	HDC-HA-004.1	4P 10A	2	YE6804-1000100
40	FM	风扇/Fan	SUNON	DP-200A	230VAC 40W	1	YM60121200400
41	M1	风机/Blower	SHINI	-----	400V 0.4kW	1	-----
42	M2	风机/Blower	SHINI	-----	400V 0.4kW	1	-----
43	M3	风机/Blower	SHINI	-----	400V 1.5kW	1	-----
44	M4	马达/Motor	----	-----	230V 0.015kW	1	-----
45	EH1	电加热器/Heater	SHINI	-----	400V 3.9kW	1	-----
46	EH2	电加热器/Heater	SHINI	-----	400V 3kW	1	-----
47	S10	通信接口板IS-485 (雙Deub=9pin接頭)	--	--	--	1	YE90048501200
48		外觀IS485 (SAL-700G-A-19)0版	--	--	--	1	YR40048500000
49							
50							
A							
B							
C							
D							
整机版本Ver.D							
注: (1)表示非电箱内材料; (2)表示选配件							
标题			版号		图号		比例
SCD-80U/50H-0P			E		SCD-80U/50H-0P-PUMP-CE-4.00V-E-6		第 6 张
电气元件明细表二			核 准		SCD-80U/50H-0P-PUMP-CE-4.00V-E-6		共 6 张
			日期		信易塑料机械股份有限公司 Shini Plastics Technologies, Inc.		机器电压
			20170620				4.00V
标记			更改后		更改人		机器频率
			日期				50Hz
1			2		3		4
5			6		7		8

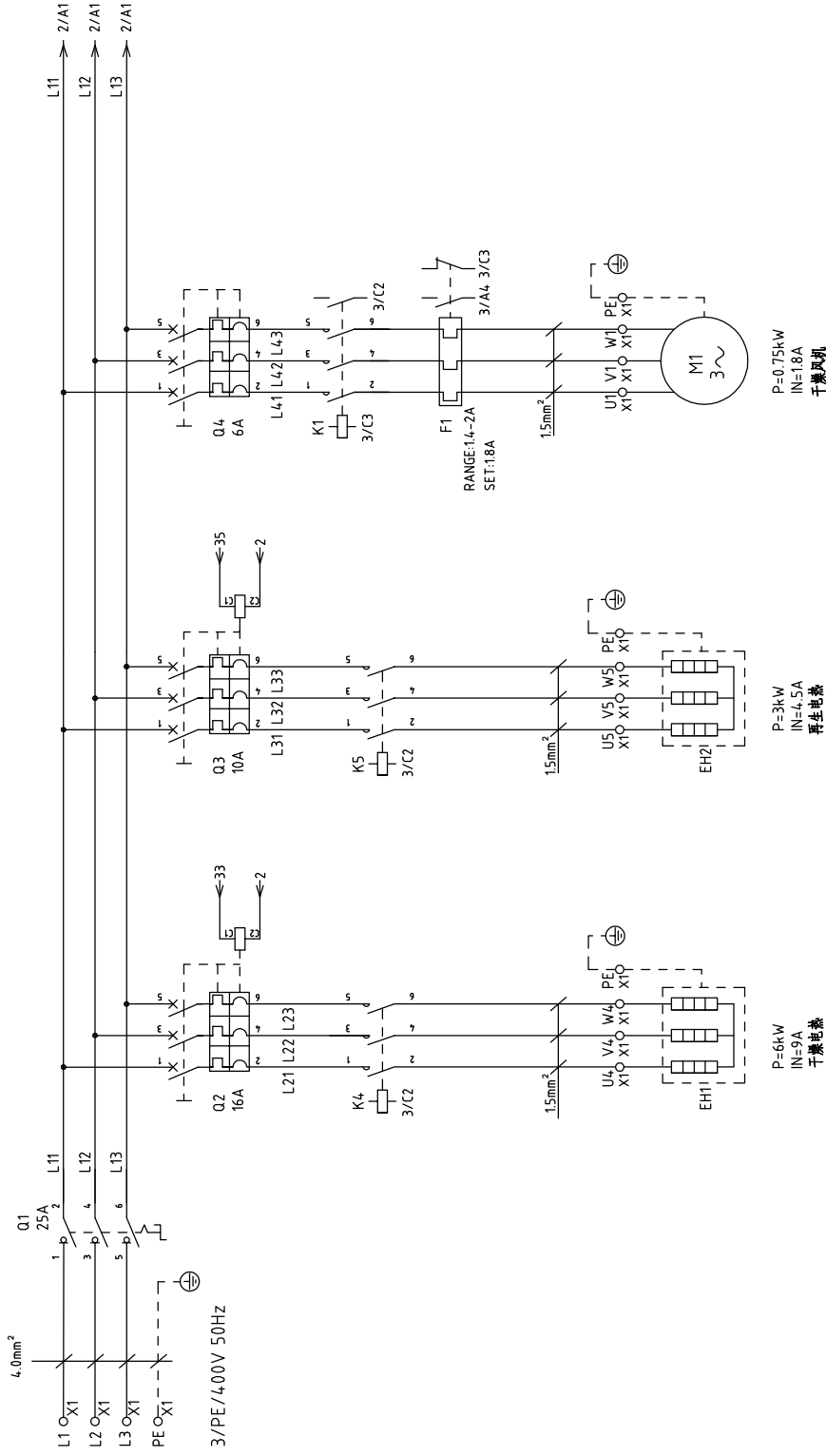

整机版本 Ver.D

制图		版号		标题		图号		比例		第 1 张	
设计	核 准	E		SCD-120U/80H-OP 主电路图一		SCD-120U/80H-OP-PUMP-CE-400V-E-1		标准	CE	共 6 张	张
校对								机器电压	400V		
审核	日期	日期	20170620					机器频率	50Hz		
更改前	更改后	更改人	更改日期								



信易塑料机械股份有限公司
Shini Plastics Technologies, Inc.

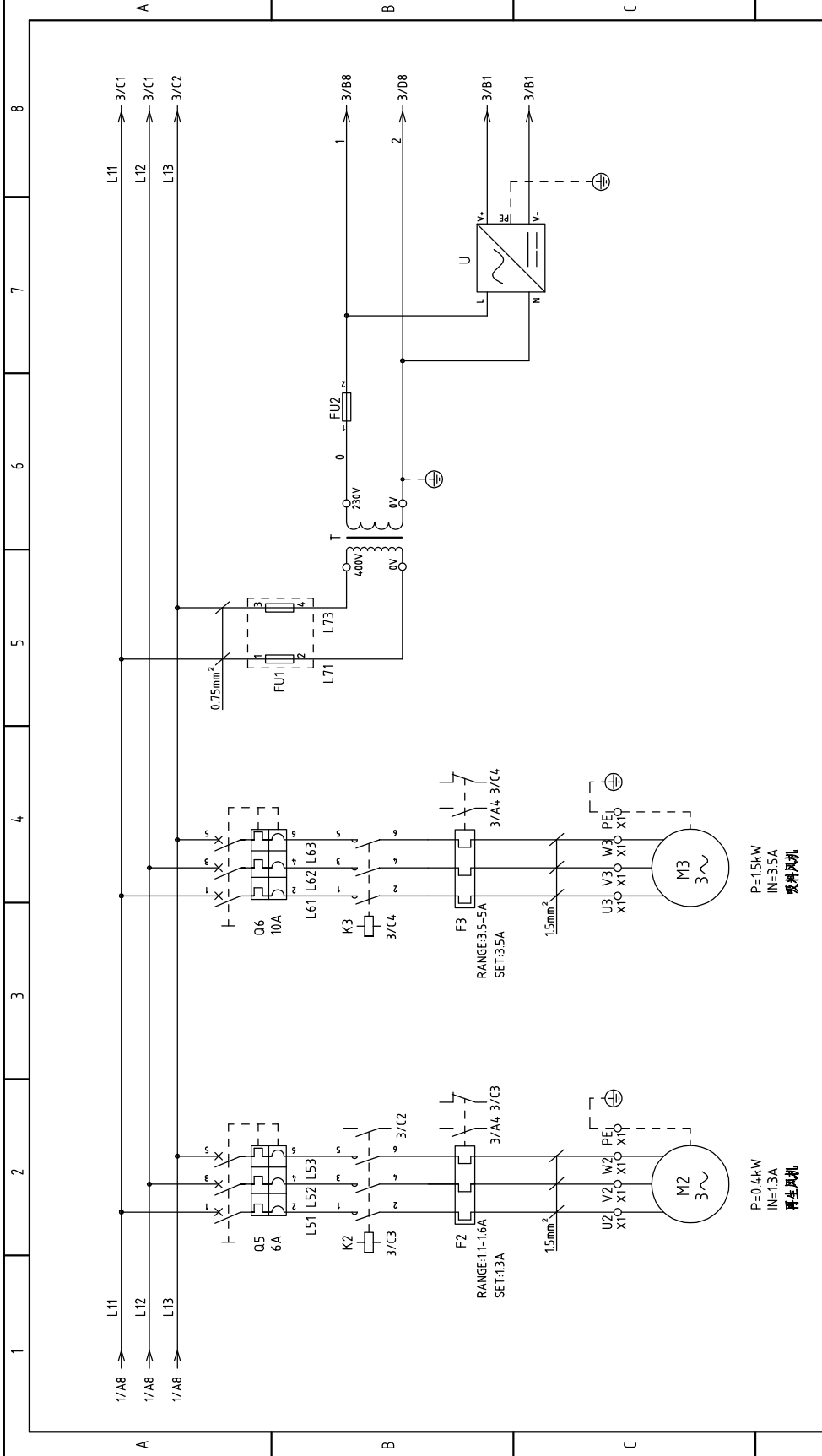

整机版本 Ver.D

制图	版号	标题	图号	比例	第 2 张
设计	核 准	SCD-120U/80H-OP 主电路图二	SCD-120U/80H-OP-PUMP-CE-400V-E-2	标准	共 6 张
校对	日期	 信易塑料机械股份有限公司 Shini Plastics Technologies, Inc.	信易 Shini Plastics Technologies, Inc.	机器电压	400V
审核	日期			机器频率	50Hz
更改前	更改后	更改人	日期	20170620	8

1	2	3	4	5	6	7	8
序号/NO	符号/Symbol	名称/Name	制造商/Manufacturer	型号/Type	规格/Specification	数量/Number	物料编号/Material number
1	Q1	主电源开关/Main power switch	EATON	P1-25/EA/SVB	25A	1	YE10I25250000
2	Q2	断路器/Circuit-breaker	TECO	BM-63C 3P	16A	1	YE4-0301603000
3	Q3 Q6	断路器/Circuit-breaker	TECO	BM-63C 3P	10A	2	YE4-0301003000
4		励磁线圈器/Excitation release	TECO	MX	220V 50/60Hz	2	YE4-0023560000
5	Q4 Q5	断路器/Circuit-breaker	TECO	BM-63C 3P	6A	2	YE4-0300603000
6	K1 K2 K3	接触器/Contactor	SIEMENS	3RT6016-1AN21	220V 50/60Hz	3	YE00601621000
7	K4	接触器/Contactor	SIEMENS	3RT6018-1AN21	220V 50/60Hz	1	YE006018000000
8	K5	接触器/Contactor	SIEMENS	3RT6017-1AN21	220V 50/60Hz	1	YE00601721000
9	K7 K8	中间继电器/Middle relay	WEDMULLER	DRM270730LT	220V 50/60Hz	2	YE03270700000
10	F1	热过载继电器/Overload relay	SIEMENS	3RU5116-1BB0	1.4--2A	1	YE0114-0200000
11	F2	热过载继电器/Overload relay	SIEMENS	3RU6116-1AB0	1.1-1.6A	1	YE01160110000
12	F3	热过载继电器/Overload relay	SIEMENS	3RU6116-1FB0	3.5-5A	1	YE01160350000
13	PCB	微电脑控制板+微电脑显示屏	PUMP	K.SF878500A.01-01	-----	1	YE80878500000
14	T	变压器/Transformer	BAIYUN	BY-04-07009	IN=400V OUT=230V 500mA	1	YE704-02300800
15	U	直流电源/DC power	MEAN WELL	NES-35-24	OUT=DC24V 1.5A	1	YE713524-00100
16	FU1	熔断器/Fuse base	CHINT	RT18-32	2P	1	YE4-1032200000
17		熔断器/Fuse	CHINT	10x38 500V	2A	2	YE4-6002000100
18	FU2	熔断器/Fuse	YINDA	FS-10	2A	1	YE4-1001000000
19	S1	磁簧开关/Reed switch	FOTEK	FC-12V	24VDC	1	YE15001200000
20	S2	光电开关/Photoelectric switch	FOTEK	T18-3MNB-PE	24VDC	1	YE1514-3900000
21	S3	露点变送器/Dew-point transducer	CS	CS 217-0EM	POWER=24VDC OUT=4-20mA	1	YE90021700100
22	S4	微动开关/Micro switch	TEND	LXW5-11G1	250V 5(4)A	1	-----
23	S5 S6	温度保护器/Temperature protector	EGO	WR-A-50-300-2500-3	250V 5(4)A	2	-----
24	S7 S8 S9	热电阻/Thermocouple	SHINI	ST-K	K	3	-----
25	Y1,Y2	电磁阀/Solenoid valve	FESTO	MSFW-230-50/60	220V 50/60Hz	2	-----
整机版本 Ver.D							
注: (1)表示非电控箱内材料; (2)表示选配件							
制图			版号		图号		比例
设计			E		SCD-120U/80H-OP		第 5 张
校对			核 准		电气元件明细表一		共 6 张
日期			20170620		SCD-120U/80H-OP-PUMP-CE-4.00V-E-5		CE
更改人			更改后		SHINI 信易塑料机械股份有限公司 Shini Plastics Technologies, Inc.		机器电压
更改前			日期		4.00V		机器频率
1			2		3		4
5			6		7		8

1	2	3	4	5	6	7	8
序号/NO	符号/Symbol	名称/Name	制造商/Manufacturer	型号/Type	规格/Specification	数量/Number	物料编号/Material number
26	H1	蜂鸣器/Buzzer	HITPOINT	PK-35A	220V	1	YE84003500200
27	H2	警报指示灯/Alarm indicator	SHINI	LED-3051	220V 50/60Hz	1	YE83305100200
28	T	变压器/Transformer	BAIYUN	BY-0407009	IN=400V OUT=230V/18V 500mA	1	YE70504000000
29	X1	端子排/Terminal board	HONEYWELL	4mm ²	4TA 690V	18	YE60000403200
30				4mm ² PE	-	6	YE60000403500
31				2.5mm ²	32A 690V	14	YE60002503200
32				2.5mm ² PE	-	4	YE60002503400
33				2.5mm ²	32A 690V	6	YE60002503200
34				2.5mm ² PE	-	2	YE60002503400
35	X2	端子排/Terminal board	----	三层弹簧端子SK2.5-TL	10A 250V	3	YE60002503600
36				FBS TB 10-ZDIK RD	10A 250V	3	YE60001000200
37				SK-2.5TL桥接件	10A 250V	3	YE60001003600
38	X3	端子排/Terminal board	HONEYWELL	2.5mm ²	32A 690V	5	YE60002503200
39				2.5mm ² PE	-	1	YE60002503400
40	X4, X5	重载插件/Heavy duty connector	SIBAS	HDC-HA-004.1	4P 10A	2	YE68041000100
41	FM	风扇/Fan	SUNON	DP-200A	230VAC 4.0W	1	YM601212004.00
42	M1	风机/Blower	SHINI	----	400V 0.75kW	1	----
43	M2	风机/Blower	SHINI	----	400V 0.4kW	1	----
44	M3	风机/Blower	SHINI	----	400V 1.5kW	1	----
45	M4	马达/Motor	----	----	230V 0.015kW	1	----
46	EH1	电蒸汽/Heater	SHINI	----	400V 6kW	1	----
47	EH2	电蒸汽/Heater	SHINI	----	400V 3kW	1	----
48	S10	通信接口板RS-485 (雙Dsub-9pin接頭)	--	--	--	1	YE900048501200
49		外觀RS485 (6AL-700G-A-19)0版	--	--	--	1	YR40048500000
A							
B							
C							
D							
整机版本 Ver.D 注: (1)表示非电箱内材料; (2)表示选配件							
制图			版号		图号		比例
设计			核 准		SCD-120U/80H-OP		标准
校对			日期		电气元件明细表二		CE
审核			日期		SCD-120U/80H-OP-PUMP-CE-4.00V-E-6		机器电压
更改后			更改人		SHINI		机器频率
更改前			日期		Shini Plastics Technologies, Inc.		4.00V
1			4		5		8
2			4		6		8
3			4		7		8
4			4		7		8
5			4		7		8
6			4		7		8
7			4		7		8
8			4		7		8