

# **SG-16N/20N**

## **Low-speed Granulator**

Date: April, 2022

Version: Ver.F (English)





## Contents

|   |           |
|---|-----------|
| <b>1. General Description .....</b>                         | <b>9</b>  |
| 1.1 Coding Principle.....                                   | 10        |
| 1.2 Feature .....   | 10        |
| 1.3 Technical Specifications .....                          | 12        |
| 1.4 Safety Regulations.....                                 | 15        |
| 1.4.1 Safety Signs and Labels.....                          | 15        |
| 1.4.2 Transportation and Storage of the Machine .....       | 17        |
| 1.5 Exemption Clause.....                                   | 19        |
| <b>2. Structural Features and Working Principle.....</b>    | <b>20</b> |
| 2.1 General Description .....                               | 20        |
| 2.1.1 Working Principle.....                                | 20        |
| 2.2 Safety System.....                                      | 21        |
| 2.2.1 Emergency Stop Switch .....                           | 21        |
| 2.2.2 Safety System .....                                   | 21        |
| 2.2.3 Hexagon Screw .....                                   | 22        |
| 2.3 Electrical Components Description .....                 | 23        |
| 2.4 Optional Accessories .....                              | 24        |
| 2.4.1 30-Sec Instant Recycling System .....                 | 24        |
| 2.4.2 Full-receiver Alarm Device .....                      | 25        |
| 2.4.3 Dust separating system .....                          | 25        |
| 2.4.4 Straight Hopper .....                                 | 26        |
| 2.4.5 Proportional Valve .....                              | 26        |
| 2.4.6 Screen .....  | 27        |
| 2.4.7 Optionally Equipped with Coiled Spring Conveyor ..... | 27        |
| 2.4.8 Height-increasing storage bin.....                    | 27        |
| <b>3. Installation and Debugging .....</b>                  | <b>28</b> |
| 3.1 Machine Location.....                                   | 29        |
| 3.2 Installation Notice.....                                | 30        |
| 3.2.1 30 Seconds Instant recycling system .....             | 31        |
| <b>4. Operation Guide .....</b>                             | <b>34</b> |

|           |   |           |
|-----------|---|-----------|
| 4.1       | Startup Pretest.....                          | 34        |
| 4.1.1     | Before the First Startup .....                | 34        |
| 4.1.2     | After First Startup for 2 Hours.....          | 34        |
| 4.1.3     | After First Startup for 20~30 Hours.....      | 35        |
| 4.2       | Start and Stop the Granulator .....           | 35        |
| 4.3       | Open the Feed Box and Storage Box .....       | 36        |
| 4.3.1     | Open the Feed Box .....                       | 36        |
| 4.3.2     | Open the Storage Box .....                    | 37        |
| 4.3.3     | Open the Screen and Screen Frame.....         | 37        |
| 4.4       | Close the Feed Box and Storage Box.....       | 38        |
| 4.4.1     | Close the Feed Box.....                       | 38        |
| 4.4.2     | Close the Feed Box.....                       | 39        |
| 4.4.3     | Shut up the Storage Box .....                 | 39        |
| 4.5       | Blades Installation Adjusting (SG-20N).....   | 40        |
| <b>5.</b> | <b>Trouble-shooting.....</b>                  | <b>41</b> |
| 5.1       | Granulator Can Not Work .....                 | 41        |
| 5.2       | Stop Due to Other Reasons.....                | 41        |
| <b>6.</b> | <b>Maintenance and Repair .....</b>           | <b>42</b> |
| 6.1       | Repair .....                                  | 42        |
| 6.1.1     | Replace the Blades .....                      | 42        |
| 6.1.2     | Transmission .....                            | 44        |
| 1.        | Daily Maintenance of V Belts .....            | 44        |
| 6.1.3     | Adjustments of V Belts .....                  | 45        |
| 6.2       | Maintenance .....                             | 46        |
| 6.2.1     | Daily check.....                              | 46        |
| 6.2.2     | Weekly Check .....                            | 47        |
| 6.2.3     | Monthly Check.....                            | 47        |
| 6.3       | Cleaning.....                                 | 47        |
| 6.4       | Installation of Bearing and Blade Rest.....   | 48        |
| 6.5       | Installation of Belt and Belt Pulley.....     | 49        |
| 6.6       | Installation of Feed Box and Feed Port.....   | 54        |
| 6.7       | Installation of Screen and Screen Frame.....  | 54        |
| 6.8       | Installation of Material Collection Box. .... | 55        |
| 6.9       | Dismantlement of Cutting Chamber Bearing..... | 57        |

|        |   |    |
|--------|---|----|
| 6.9.1  | Cutting Chamber Dismantlement .....                 | 57 |
| 6.9.2  | Take out the blade-rest shaft.....                  | 58 |
| 6.9.3  | Take out the bearing.....                           | 59 |
| 6.10   | Maintenance Schedule .....                          | 60 |
| 6.10.1 | About the Machine.....                              | 60 |
| 6.10.2 | Check After Installation.....                       | 60 |
| 6.10.3 | Daily Check .....                                   | 60 |
| 6.10.4 | Weekly Check .....                                  | 60 |
| 6.10.5 | Monthly Check.....                                  | 60 |
| 6.10.6 | Check Half-yearly or Every 1000 Running Hours ..... | 61 |
| 6.10.7 | 3 year Checking .....                               | 61 |

### Table index

|            |  |    |
|------------|--|----|
| Table 1-1: | Technical Specifications (SG-16N)..... | 13 |
| Table 1-2: | Technical Specifications (SG-20N)..... | 14 |

### Picture index

|              |   |    |
|--------------|---|----|
| Picture 1-1: | Dimensions .....                            | 12 |
| Picture 2-1: | Working Principle .....                     | 20 |
| Picture 2-2: | Emergency Stop Switch .....                 | 21 |
| Picture 2-3: | Safety System .....                         | 22 |
| Picture 2-4: | Electrical Components Description .....     | 23 |
| Picture 3-1: | Installation Space 1 .....                  | 29 |
| Picture 3-2: | Installation Place 2 .....                  | 29 |
| Picture 3-3: | 30 Seconds Instant recycling system .....   | 31 |
| Picture 3-4: | 30 Seconds Instant Recycling System 1 ..... | 31 |
| Picture 3-5: | 30 Seconds Instant Recycling System 2 ..... | 32 |
| Picture 3-6: | 30 Seconds Instant Recycling System 3 ..... | 32 |
| Picture 3-7: | 30 Seconds Instant Recycling System 4 ..... | 32 |
| Picture 3-8: | 30 Seconds Instant Recycling System 5 ..... | 33 |

|  |    |
|--|----|
| Picture 3-9: 30 Seconds Instant Recycling System 6 .....                     | 33 |
| Picture 4-1: Main Power Switch.....  | 35 |
| Picture 4-2: Stop, Emergency Stop and Startup button .....                   | 35 |
| Picture 4-3:Open the Feed Box 1 .....  | 36 |
| Picture 4-4: Open the Feed Box 2 .....                                       | 36 |
| Picture 4-5: Open the Storage Box.....                                       | 37 |
| Picture 4-6: Open the Screen and Screen Frame 1.....                         | 37 |
| Picture 4-7: Open the Screen and Screen Frame 2.....                         | 37 |
| Picture 4-8: Close the Feed Box 1 .....                                      | 38 |
| Picture 4-9: Close the Feed Box 2.....                                       | 38 |
| Picture 4-10: Close the feed box .....                                       | 39 |
| Picture 4-11: Shut up the Screen and Screen Frame.....                       | 39 |
| Picture 4-12: Blades Installation Adjusting (SG-20N).....                    | 40 |
| Picture 6-1: Maintain and Clean Blades .....                                 | 43 |
| Picture 6-2: Transmission Belt Maintenance Diagram.....                      | 45 |
| Picture 6-3: Adjustments of V Belts 1 .....                                  | 46 |
| Picture 6-4: Adjustments of V Belts 2 .....                                  | 46 |
| Picture 6-5: Star Screw.....   | 47 |
| Picture 6-6: Clearing the Dust Collection Chambers .....                     | 48 |
| Picture 6-7: Installation of Bearing and Blade Rest 1 .....                  | 48 |
| Picture 6-8: Installation of Bearing and Blade Rest 2 .....                  | 49 |
| Picture 6-9: Installation of Bearing and Blade Rest 3 .....                  | 49 |
| Picture 6-10: Installation of Bearing and Blade Rest 4 .....                 | 49 |
| Picture 6-11: Installation of Belt and Belt Pulley 1 .....                   | 50 |
| Picture 6-12: Installation of Belt and Belt Pulley 2 .....                   | 50 |
| Picture 6-13: Installation of Belt and Belt Pulley 3 .....                   | 50 |
| Picture 6-14: Installation of Belt and Belt Pulley 4 .....                   | 51 |
| Picture 6-15: Installation of Belt and Belt Pulley 5 .....                   | 51 |
| Picture 6-16: Installation of Belt and Belt Pulley 6 .....                   | 52 |
| Picture 6-17: Installation of Belt and Belt Pulley 7 .....                   | 52 |
| Picture 6-18: Installation of Belt and Belt Pulley 8 .....                   | 52 |
| Picture 6-19: Installation of Belt and Belt Pulley 9 .....                   | 53 |
| Picture 6-20: Installation of Feed Box, Feed Port and Storage Hopper 1 ..... | 54 |
| Picture 6-21: Installation of Feed Box, Feed Port and Storage Hopper 2 ..... | 54 |

|   |    |
|---|----|
| Picture 6-22: Installation of Screen and Screen Frame 1 ..... | 55 |
| Picture 6-23: Installation of Screen Frame 1 .....            | 55 |
| Picture 6-24: Installation of Screen Frame 2.....             | 55 |
| Picture 6-25:Installation of Material Collection Box 1.....   | 56 |
| Picture 6-26:Installation of Material Collection Box 2.....   | 56 |
| Picture 6-27:Installation of Material Collection Box 3.....   | 56 |
| Picture 6-28:Installation of Material Collection Box 4.....   | 56 |
| Picture 6-29: Step 1 of Cutting Chamber Dismantlement .....   | 57 |
| Picture 6-30: Step 2 of Cutting Chamber Dismantlement .....   | 57 |
| Picture 6-31: Step 3 of Cutting Chamber Dismantlement .....   | 57 |
| Picture 6-32: Step 4 of Cutting Chamber Dismantlement .....   | 58 |
| Picture 6-33: Step 1 to Take Out the Blade-rest Shaft.....    | 58 |
| Picture 6-34: Step 2 to Take Out the Blade-rest Shaft.....    | 58 |
| Picture 6-35: Step 3 to Take Out the Blade-rest Shaft.....    | 58 |
| Picture 6-36: Step 1 to Take Out the Bearing .....            | 59 |
| Picture 6-37: Step 2 to Take Out the Bearing .....            | 59 |
| Picture 6-38: Step 3 to Take Out the Bearing .....            | 59 |





# 1. General Description



Please read this manual carefully before using this machine in order to operate correctly against any damage caused due to improper operation.



Note!

Always take great care when the knives are within reach, they are very sharp and can cause personal injury.



Forbidden to process flammable or toxic material!

SG-16N/20N series low-speed granulators are suitable for crushing sprues material and a few rejects. It is set on the side of Plastics Molding Machines and Picker, collocating with belt conveyor. It features low speed, big driving torque, low noise, little dust level and simple operation.



Model: SG-1635N

## 1.1 Coding Principle

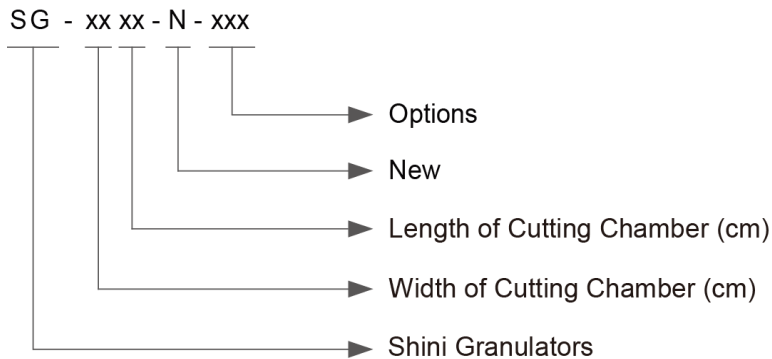

## 1.2 Feature

- SG-16N/SG-20NC series adopts staggered blades and unfixed blades to diffuse impact load, improve cutting efficiency. The blade rest design without adjustment makes blade replacement more convenient.
- Low granulating speed and sharp angle design of rotating blades are helpful for smooth and continuous operation.
- SG-20N series is equipped with presetting knife jig, simple cutter installation adjusting technology makes the rotating blades and fixed blades be adjusted within clamps outside machine, no longer needs to be adjusted from inside of machine as before.
- The material collector is located outside the custtine chamber to avoid leakage.
- Optimal cutting angle makes resistance small and avoid blockage to improve cutting efficiency.
- Optimal design can effectively reduce vibration during operation of granulator.
- Low speed granulating ensures well-proportioned granules and low dust level.
- Low speed and sound-proof material hopper brings a quieter operation environment.
- Easy access for easy maintenance and cleaning.
- Small in size with castors for easy moving.
- High safety grade design to comply with European safety standard.
- With built-in magnet installed at the inlet of the feeding chamber, metal impurities in the materials can be avoided.

All service work should be carried out by a person with technical training or corresponding professional experience. The manual contains instructions for both handling and servicing. Chapter 6, which contains service instructions intended for service engineers. Other chapters contain instructions for the daily operator.

Any modifications of the machine must be approved by SHINI in order to avoid personal injury and damage to machine. We shall not be liable for any damage caused by unauthorized change of the machine.

Our company provides excellent after-sales service. Should you have any problem during using the machine, please contact the company or the local vendor.

Shini Hotline Service:

Headquarter and Taipei factory:

Tel: + 886 (0)2 2680 9119

Shini Plastics Technologies (Dongguan), Inc.:

Tel: +86 (0)769 8331 3588

Shini Plastics Technologies (Pinghu), Inc.:

Tel: +86 (0)573 8522 5288

Shinden Precision Machinery (Chongqing), Inc.:

+86 (0)23 6431 0898

### 1.3 Technical Specifications

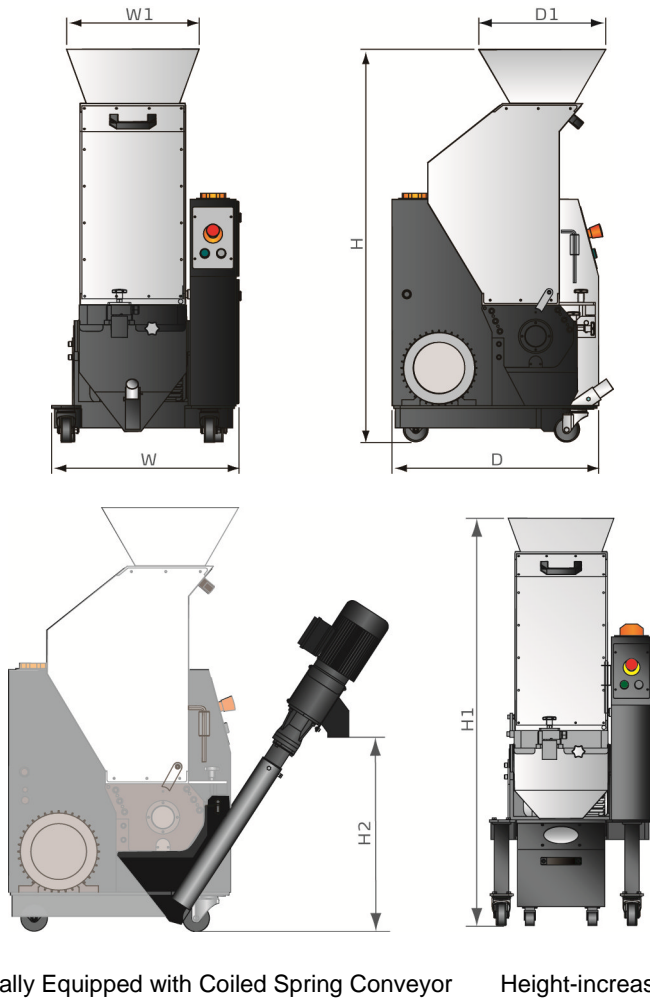

Optionally Equipped with Coiled Spring Conveyor

Height-increasing storage bin

Picture 1-1: Dimensions

Table 1-1: Technical Specifications (SG-16N)

| Model                            | SG-1621N  | SG-1628N  | SG-1635N(H)         |
|----------------------------------|-----------|-----------|---------------------|
| Ver.                             | F         | F         | F                   |
| Motor Power (kW, 50/60Hz)        | 1.5/1.75  | 2.2/2.55  | 2.2/2.55 (3.0/3.45) |
| Rotating Speed (rpm, 50/60Hz)    | 230/278   | 235/285   | 235/285 (240/290)   |
| Material of Blades               | SKD11     | SKD11     | SKD11               |
| Type of Blades                   | Staggered | Staggered | Staggered           |
| Number of Fixed Blades           | 2×1       | 2×1       | 2×2                 |
| Number of Rotating Blades        | 9         | 12        | 15                  |
| Presetting Knife Jig             | -         | -         | -                   |
| Cutting Chamber (mm)             | 160×210   | 160×280   | 160×350             |
| Max. Throughput Capacity (kg/hr) | 35        | 50        | 60 (80)             |
| Noise Level dB(A)                | 85~90     | 85~90     | 85~90               |
| Dia. of Screen Mesh (mm)         | (Φ5)      | (Φ5)      | (Φ5)                |
| Dimensions                       |           |           |                     |
| H (mm)                           | 1200      | 1200      | 1200                |
| H1(mm)                           | 1400      | 1400      | 1400                |
| H2(mm)                           | 550       | 550       | 550                 |
| W (mm)                           | 505       | 575       | 645                 |
| W1 (mm)                          | 330       | 400       | 470                 |
| D (mm)                           | 630       | 630       | 630                 |
| D1 (mm)                          | 385       | 385       | 385                 |
| Weight (kg)                      | 175       | 195       | 210/225             |

Note: 1) "√" stands for standard.

- 2) Max. capacity of the machine is subject to diameter of screen hole and composition of the material. Continually with PET preforms.
- 3) Noise level will vary with different materials and motor types.
- 4) For avoiding plastic to adhibit the blade, all materials should be crushed at normal temperature.
- 5) Power supply: 3Φ, 230 / 400 / 460 / 575VAC, 50 / 60Hz.

Table 1-2: Technical Specifications (SG-20N)

| Model                            | SG-2028N(H)            | SG-2028NC(H) | SG-2042N(H)           | SG-2042NC(H) |
|----------------------------------|------------------------|--------------|-----------------------|--------------|
| Ver.                             | F                      | F            | F                     | F            |
| Motor Power (kW, 50/60Hz)        | 2.2<br>/2.55(3.0/3.45) | 2.2(3.0)     | 3.0/3.45<br>(4.0/4.6) | 3.0(4.0)     |
| Rotating Speed (rpm)             | 290/350                | 290          | 290/350               | 290          |
| Material of Blades               | SKD11                  | SKD11 (D2)   | SKD11                 | SKD11 (D2)   |
| Type of Blades                   | Paddle Blades          | Staggered    | Paddle Blades         | Staggered    |
| Number of Fixed Blades           | 2                      | 2            | 2                     | 2            |
| Number of Rotating Blades        | 3                      | 12           | 3                     | 18           |
| Cutting Chamber                  | ✓                      | -            | ✓                     | -            |
| Presetting Knife Jig(mm)         | 200×280                | 200×280      | 200×420               | 200×420      |
| Max. Throughput Capacity (kg/hr) | 80                     | 80           | 135                   | 135          |
| Noise Level dB(A)                | 85~90                  | 85~90        | 85~90                 | 85~90        |
| Dia. of Screen Mesh (mm)         | (Φ6)                   | (Φ6)         | (Φ6)                  | (Φ6)         |
| Dimensions                       |                        |              |                       |              |
| H (mm)                           | 1270                   | 1270         | 1270                  | 1270         |
| H1 (mm)                          | 1450                   | 1450         | 1450                  | 1450         |
| H2 (mm)                          | 550                    | 550          | 550                   | 550          |
| W (mm)                           | 575                    | 575          | 715                   | 715          |
| W1 (mm)                          | 367                    | 367          | 507                   | 507          |
| D (mm)                           | 695                    | 695          | 695                   | 695          |
| D1 (mm)                          | 375                    | 375          | 375                   | 375          |
| Weight (kg)                      | 265/280                | 280/295      | 300/315               | 320/335      |

Note: 1) " ✓ " stands for standard.

- 2) Max. capacity of the machine is subject to diameter of screen hole and composition of the material.  
The listed maximum output is tested continually with PET preforms.
- 3) Noise level will vary with different materials and motor types.
- 4) For avoiding plastic to adhibit the blade, all materials should be crushed at normal temperature.
- 5) Power supply: 3Φ, 400 / 460 / 575VAC, 50 / 60Hz.

## 1.4 Safety Regulations

Follow the instructions in this manual to avoid personal injury and damage to machine components.

### 1.4.1 Safety Signs and Labels



Electrical installation must only be done by a competent electrician!



Before the granulator is opened for servicing and maintenance, always disconnect the power with both the main switch and the control switch on the granulator.



Never put any part of your body through the granulator openings, unless both the main switch and the control switch on the granulator are in "Off" position.



High voltage! Danger!

This sign is attached on the control box and the wiring box.



Be careful with the rotating knives, they are very sharp and can cause personal injury!



Be careful with the rotating knives, they are very sharp and can cause personal injury!



The granulator should not be able to start before the feed box and screen frame are properly closed.



Attention please!

Ear protection is used during granulating of plastic materials.



Attention!

No need for regular inspection because all the electrical parts in the control unit are fixed tightly!



Make sure the power has been cut off before opening the feed box.



Loading blower is applicable to convey regrind and powder, and it requires that the temperature of regrind and powder should not be more than 80°C.



The loading blower has great suction power and it is easy to get things or clothes sucked into, so it should have a protective cover.



Air inlet dust clean.



Concerning SG-20N the cutting chamber should be heat-processed and the blades must be changed before the granulator deal with fibre added material.

When operate the granulator, please notice the following signs

|  |   |
|--|---|
|  | Hazard<br>High voltage!<br>May lead to casualty or other serious danger.<br>Please cut off the power before repairing.<br>Circuit diagram should only be changed by professionals.<br>Grounding is necessary. |
|  | Warning<br>Pinch risk when moving belt.<br>Take out or open protective cover is not allowed when it is running.   |
|  | Warning<br>The cutter are very sharp, can cause injury<br>take out or open protective cover is not allowed when it is running.<br>Keep some distance away from the cutters.                                   |



|   |   |
|---|---|
|   |  Notice<br>Read the instruction manual carefully before operating.<br>Before start, do the safety device test according to the instruction. It is not allowed to change the design of the machine unless it is approved from the manufacturer. |
| <p>請注意正確運轉方向</p> <p>Motor rotation direction</p> <p>YP31000021300</p> | This is to indicate motor rotating direction. When phase reversal happens, the alarm sounds and indicator on control panel will indicate.<br>Please exchange the place of two of the electrical wires to solve this problem.  |

## 1.4.2 Transportation and Storage of the Machine

### Transportation

- 1) SG-16N / 20N series of granulator are packed in plywood cases with wooden pallet at the bottom, suitable for quick positioning by fork lift.
- 2) After unpacked, castors located at the bottom of the machine can be used for easier movement.
- 3) Do not rotate the machine and avoid collision with other objects during transportation to prevent improper functioning.
- 4) The structure of the machine is well-balanced and has device for transportation although it should also be handled with care when lifting the machine for fear of falling down.
- 5) The machine and its attached parts can be kept at a temperature from  $-25^{\circ}\text{C}$  to  $+55^{\circ}\text{C}$  for long distance transportation and for a short distance, it can be transported with temperature under  $+70^{\circ}\text{C}$ .

### Storage

- 1) SG-16N / 20N series granulator should be stored indoors with temperature kept from  $5^{\circ}\text{C}$  to  $40^{\circ}\text{C}$  and humidity below 80%.
- 2) Disconnect all power supply and turn off main switch and control switch.
- 3) Keep the whole machine, especially the electrical components away from water to avoid potential troubles caused by the water.
- 4) Plastic film should be used to protect the machine from dust and rains.

## Working Environment

The machine should be operated: Indoors in a dry environment with max. temperature +45°C and humidity no more than 80%.

Do not use the machine:



- 1) If it is with a damaged cord.
- 2) On a wet floor or when it is exposed to rain to avoid electrical shock.
- 3) If it has been dropped or damaged until it is checked or fixed by a qualified serviceman.
- 4) This equipment works normally in the environment with altitude within 3000m.
- 5) At least a clearance of 1m surrounding the equipment is required during operation. Keep this equipment away from flammable sources at least two meters.
- 6) Avoid vibration, magnetic disturbance at the operation area.

## Rejected Parts Disposal

When the equipment has run out its life time and can not be used any more, unplug the power supply and dispose of it properly according to local code.



Fire hazard

In case of fire, CO<sub>2</sub> dry powder fire extinguisher should be applied.



Flammable materials or materials which are contaminated by flammable substances/liquid may not be processed in the granulator. Serious risk of fire or explosion.



It is very important to tighten the screw as required torque.



When process item is longer than hopper through, please cut long items into half until the length is shorter before processing.



Please don't put materials into the granulator if they are thinner than 2mm and are soft and flexible, like rubber.

## 1.5 Exemption Clause

The following statements clarify the responsibilities and regulations born by any buyer or user who purchases products and accessories from Shini (including employees and agents).

Shini is exempted from liability for any costs, fees, claims and losses caused by reasons below:

1. Any careless or man-made installations, operation and maintenances upon machines without referring to the Manual prior to machine using.
2. Any incidents beyond human reasonable controls, which include man-made vicious or deliberate damages or abnormal power, and machine faults caused by irresistible natural disasters including fire, flood, storm and earthquake.
3. Any operational actions that are not authorized by Shini upon machine, including adding or replacing accessories, dismantling, delivering or repairing.
4. Employing consumables or oil media that are not appointed by Shini.

## 2. Structural Features and Working Principle

### 2.1 General Description

Granulator of SG-16N / 20N series are designed for grinding different types of plastic waste. The granulator is controlled by main power switch, emergency stop button, safety switch, start and stop button.

#### 2.1.1 Working Principle

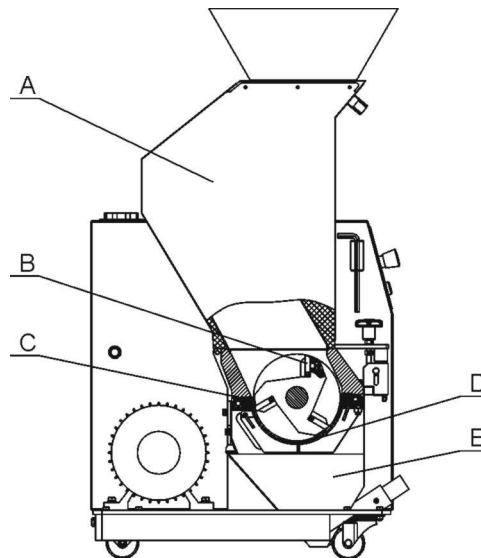

Parts name:

A. Feed box B. Rotating blade C. Fixed blade D. Screen E. Storage box

Picture 2-1: Working Principle

The material is fed in via feed box (A) and falls down to the rotating blades (B) there it grind the material against the fixed blades (C) in the cutting chamber. Underneath there is a screen (D) which the granulate passes through before it is gathered in the storage box (E). The storage box, screen and screen frame are removable. The feed box can also be opened up for easy cleaning and maintenance.

## 2.2 Safety System

To avoid accidental bodily injury during granulator running, a set of safety system has been designed. In any cases, the safety system cannot be changed at random. Otherwise the machine will be under dangerous condition and subject to accident happening. The maintenance and preservation of safety system shall be done by professional staff. In case the safety system of granulator is changed, our company will not perform our commitment. The replacement of all spare parts will be done by SHINI Company.

### 2.2.1 Emergency Stop Switch

There is one red button on the control panel. Upon pushing it, the machine will stop running. Turn the button in the arrow direction as shown on the button, the button will reset (counter-clockwise).



Picture 2-2: Emergency Stop Switch

### 2.2.2 Safety System

On the granulator is equipped the safety position switch for the breaker. In case the position of storage box or feed box is changed or the breaker is loosened, it will cut off the power supply.

There is one safety switch on the granulator locating between the feed box and the storage box.

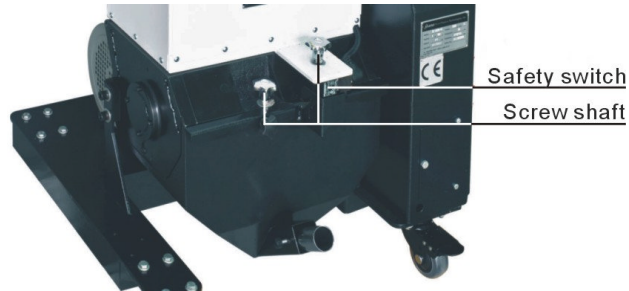

Picture 2-3: Safety System

### 2.2.3 Hexagon Screw

When opening the feed box and granulator chamber, a long hexagon screw should be loosed (it's just the door lock). It will take a long time to loosen the screw. And this period of time is enough for stopping the blade bearing completely to avoid personnel injury.

Prior to machine switch-on, please notice:

- 1) Check if the feed box has been locked up.
- 2) Shut the screen frame and lock the star screw tightly.

## 2.3 Electrical Components Description



Picture 2-4: Electrical Components Description

1. Circuit breaker, which performs the function of short circuit protection or circuit isolation.
2. Electromagnetic switch, which can connect or disconnect the power from remote.
3. Thermo overload relay, which can protect the gear motor when they are overloading or phase failure
4. Transformer, which can provide suitable voltage for the control circuit.

## 2.4 Optional Accessories

- For granulating fibre-added material, it increases fibre-added granulator model for choose. Adopt surface-hardening treatment on the material contacting components. SG-20N fibre-added model chooses V-4E blade material. Add “F” at the model behind.
- Optional higher Motor Power Add “H” at the model behind.

### 2.4.1 30-Sec Instant Recycling System

1) VR Type 30-Sec Instant Recycling (Especially suitable for white and transparent material)

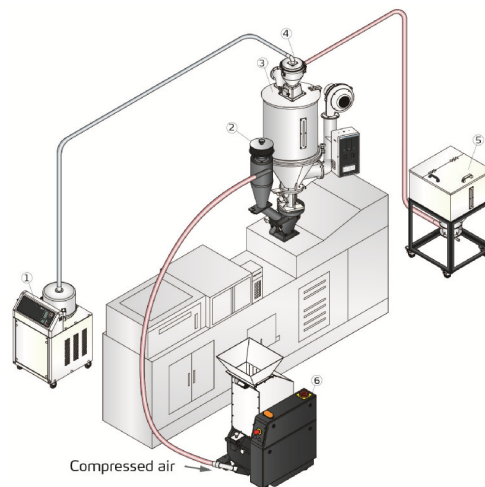

2) BR Type 30-Sec Instant Recycling

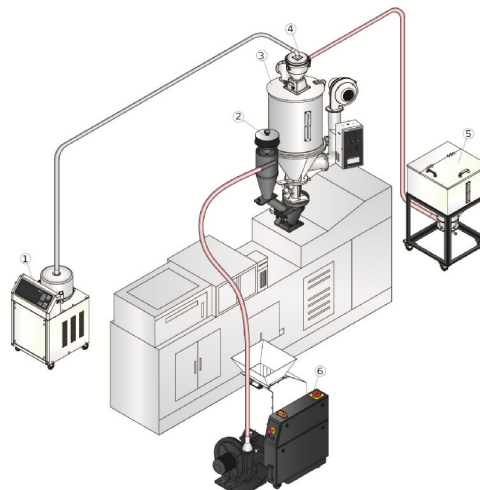



### 2.4.2 Full-receiver Alarm Device



Full-receive alarm device can help to realize unmanned operation and no materials will be wasted. Whenever the regrind level reaches the motor position, the machine will be forced to stop and be cut off via it is sensor, thus stop the granulator and warn the user by sounding an alarm. Applicable to SG-16N/20N series.

### 2.4.3 Dust separating system



Regrind Conveying Via Blower  
& Cyclone (BC Type)



Dust Separator (DS Type)

This device utilizes loading blower to convey regrind into the cyclone dust collector to separate the regrind from the air and then the regrind will fall into storage hopper or cloth bag.

Dust Separator (DS type) can enhance dust separation with regrind for immediate use. The dust will be kept in filter bag, thus working environment will be maintained clean. This device ensures full use of regrind to avoid material wasting and enhance the economy returns.

#### 2.4.4 Straight Hopper

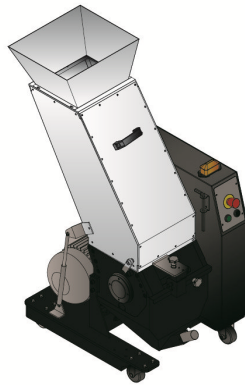

Straight hopper has been designed to meet the demand of grinding pipes and runners. Applicable to SG-20N blades series(exclusive of SG-2028NH).

#### 2.4.5 Proportional Valve



Proportional valves mix regrind with new materials in a proper proportion, and then send them back to the IMM. It features easy installation and excellent accuracy. For details, please refer to the brochure of SPV-U.

## 2.4.6 Screen

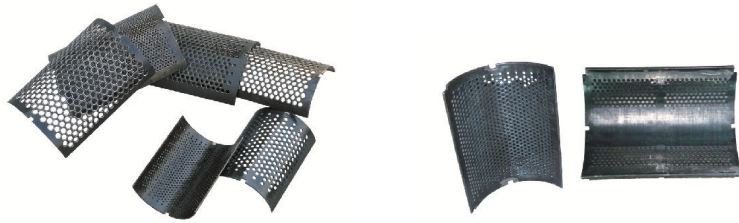

Special Screen

Double-layer Screen

Special screen mesh sizes includes  $\Phi 4$ ,  $\Phi 6$ ,  $\Phi 8$ ,  $\Phi 10$ ,  $\Phi 12$ (mm), which are applicable to SG-16N series; and screen mesh size  $\Phi 4$ ,  $\Phi 5$ ,  $\Phi 7$ ,  $\Phi 8$ ,  $\Phi 10$ ,  $\Phi 12$  (mm) are applicable to SG-20N series.

For customer's demands, our company customized the double-layer screen and tilted-hole screen for the customer especially for the slender materials filtering.

## 2.4.7 Optionally Equipped with Coiled Spring Conveyor

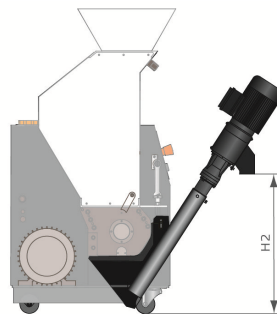

## 2.4.8 Height-increasing storage bin

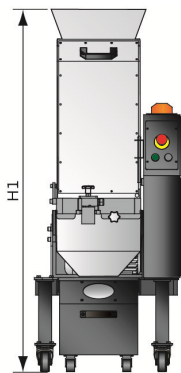

Height-increasing storage tank helps to collect and store regrind. Applicable to SG-16N/20N series.

### 3. Installation and Debugging



Read this chapter carefully before installation.



Install as following orders to avoid any accident!



Be careful! Not to be cut by the sharp blade.



Power connection must be done by the professional electrician to avoid electrical shock.



Caution!

Cutters should be laid level, prevent the cutters from self-rotating when do installation, don't let your hands be near to the cutters to avoid personal injury.



Notice!

Do not install the cutters by working together, because this could bring personal injury. Use a thick wood block to stop the rotating knives from turning.



Notice!

The blades are very sharp, so use protective gloves to avoid being cut.



Notice!

Please use new screws and gaskets when installing cutters.

### 3.1 Machine Location

Make at least 1 meter clearance around the machine to facilitate repair and maintenance.



Picture 3-1: Installation Space 1

Check and make sure the installation ground is level, there is enough intensity when it is running.

Lockup the castors to prevent the granulator from moving.

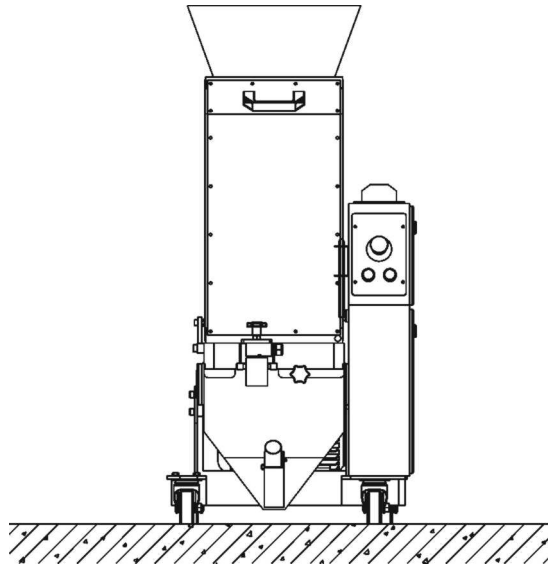

Picture 3-2: Installation Place 2

## 3.2 Installation Notice

- 1) Make sure voltage and frequency of the power source comply with those indicated on the manufacture's plate, which is attached to the machine.
- 2) Power cable and earth connections should conform with local regulations.
- 3) Use independent power cable and ON/OFF switch. The cable's dia. Should not smaller than those applied in the control box.
- 4) The power cable connection terminals should be tightened securely.
- 5) The machine requires a 3-phase 4-wire power source, connect the power lead (L1, L2, L3) to the live wires, and the earth (PE) to the ground.
- 6) Power supply requirements:  
Main power voltage:  $\pm 5\%$   
Main power frequency:  $\pm 2\%$
- 7) Specific power supply specifications please refer to the schematic model.



### CAUTION!

The installation of the granulator's circuit must be conducted by the professional electricians.

- 1) Connect granulator to the power.
- 2) Connect the transmission belt clockwise.

### Check the Running Direction of the Motor

- 1) Open the door to check whether the feed box is closed.
- 2) Ensure the main power switch is in ON position.
- 3) Check the emergency stop.
- 4) Start the granulator via pressing the START button and stop the granulator via pressing the STOP button.
- 5) The granulator needs some time to fully come to a halt; After full stop, check whether the running direction is clockwise.



### CAUTION!

The cutting tools may be damaged and the granulating capability will be reduced if there is a wrong running direction. Please disconnect the power and transpose any two wires of the three in the main power.

### 3.2.1 30 Seconds Instant recycling system

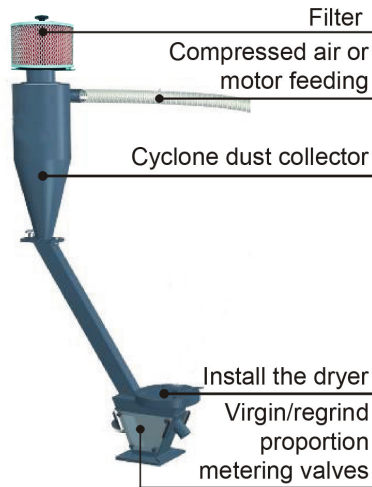

Picture 3-3: 30 Seconds Instant recycling system

This device utilizes high pressure air or loading blower to easily convey the regrind material within storage box to "new and regrind material proportion governor" to get mixed and recycled, so to keep it from quality and color changing by oxidation or dampening.

- 1) Align flange base to the hole of 30 seconds instant recycling system and use M8×35 screw to fix it.

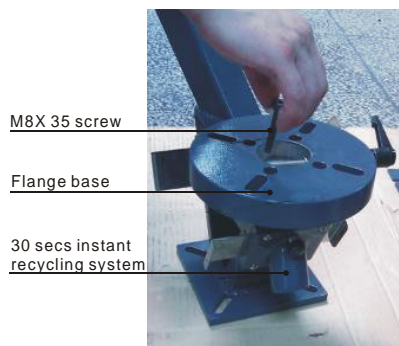

Picture 3-4: 30 Seconds Instant Recycling System 1

- 2) Fix the bend and the cyclone dust collector with M5×15 screw and pay special attention to the direction of the bend, it can not be at the same side with the air inlet of the cyclone dust collector.

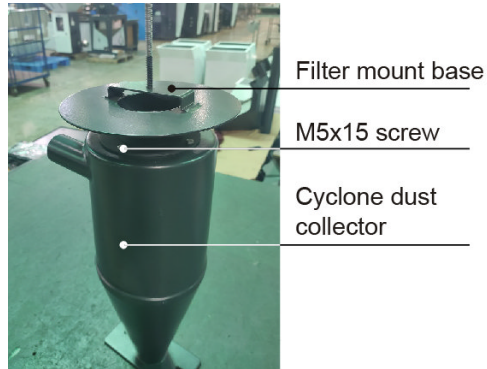

Picture 3-5: 30 Seconds Instant Recycling System 2

3) Fix the cyclone dust collector and the 30 seconds instant recycling system with M8 screw nuts and lockup screws.

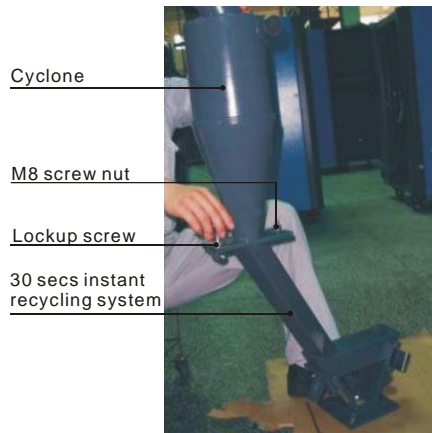

Picture 3-6: 30 Seconds Instant Recycling System 3

4) Put a filter on the screw of the mount base, and lock the filter with a star nut.

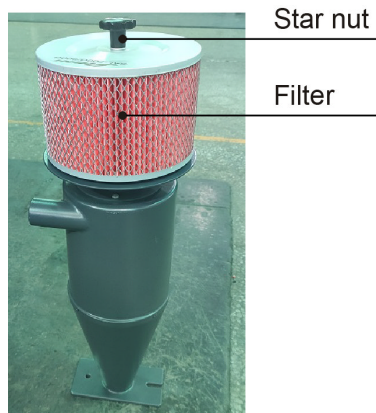

Picture 3-7: 30 Seconds Instant Recycling System 4



5) Use steel wired hose to connect the outlet of loading blower to the inlet of the cyclone dust collector.

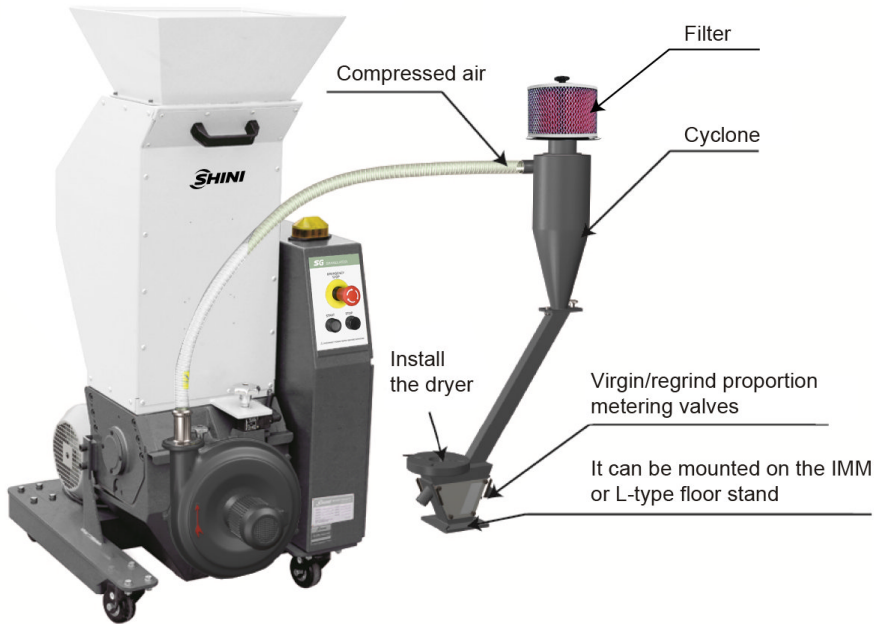

Picture 3-8: 30 Seconds Instant Recycling System 5

6) Mount drying machine at the flange base of the 30 seconds instant recycling system.

To mount drying machine on flange base

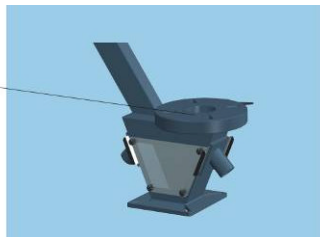

Picture 3-9: 30 Seconds Instant Recycling System 6

## 4. Operation Guide



Wear earplugs during operating to avoid personal injury!



Wear gloves during operating to avoid personal injury!



Wear goggles during operating to avoid personal injury!



Because the blades and rotor may be loosen, check the following items before operating:

- 1) If the blades has any damage.
- 2) If the surface of the rotor is loosen.
- 3) Push or pull the rotor and blades to see if there is any loose connection.

If any of the above situations is found, please contact local representative or SHINI Company for help.

### 4.1 Startup Pretest

Unpainted part of the machine has been covered with stainless oil. Before use, the stainless oil should be cleaned.

- 1) Clean with a towel.
- 2) Wash with a towel dipping with amyl acetate.

#### 4.1.1 Before the First Startup

- 1) Check whether the granulator is in the level state.
- 2) Check the space of the cutting tools to see whether the lockup screws of the blades are tightened (torque: 280Nm).

#### 4.1.2 After First Startup for 2 Hours

- 1) Check the space of the cutting tools of the fixed blades and rotating blades again; check whether the lockup screws of the blades are loose.
- 2) Check the position-adjusting screws of the motor and check whether the position-adjusting screws are tightened.

### 4.1.3 After First Startup for 20~30 Hours

Check and adjust the belt's tensility after a 20~30-hour full-load operation.

## 4.2 Start and Stop the Granulator

The granulator is controlled by circuit breaker, safety switch, START / STOP button and emergency stop button.

Main power switch:

It is located at the front control panel. Through rotating the switch to control the startup and stop of the machine.



Picture 4-1: Main Power Switch

START button and STOP button:

These two buttons control the startup and stop of the machine.

Emergency stop:

When an accident happens, this button can do a favor.

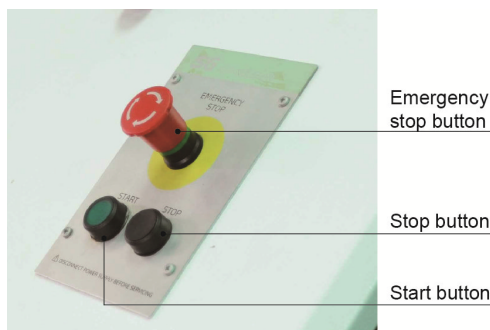

Picture 4-2: Stop, Emergency Stop and Startup button



### CAUTION!

If there are ungrinded crew materials in the feed box or cutting chamber, the granulator shall NOT be stopped, otherwise the crew materials will blockade the rotor and the motor will be overloaded next time you start the machine up.

## 4.3 Open the Feed Box and Storage Box



Before opening the feed box and the storage box, turn off the main power switch and the power switch of the granulator.



Be careful! The blade is very sharp, please take care.

### 4.3.1 Open the Feed Box

- 1) Hold the safety-switch mounting plate by left hand, rotate the star screw anticlockwise to the lower limit of the safety-switch mounting plate. Hold the feed box by right hand and put it down slowly, make the limit block supporting on the limit sleeve.



Limit block is supported on the limit sleeve

Picture 4-3: Open the Feed Box 1

- 2) Anticlockwise loosen the star screw with right hand continuously and open the feed box.



Picture 4-4: Open the Feed Box 2

### 4.3.2 Open the Storage Box

- 1) Shut off the power of granulator.
- 2) Remove the storage box.



Picture 4-5: Open the Storage Box

### 4.3.3 Open the Screen and Screen Frame

- 1) Shut off the power of granulator.
- 2) Loose the inner hexagon screws and open the screen frame.



Picture 4-6: Open the Screen and Screen Frame 1

- 3) Take out screen and screen frame.



Picture 4-7: Open the Screen and Screen Frame 2

## 4.4 Close the Feed Box and Storage Box

### 4.4.1 Close the Feed Box

- 1) Close the feed box, make the limit block supporting on the limit sleeve. Hold the safety-switch mounting plate with left hand, aim the hole and twist the star screw clockwise.

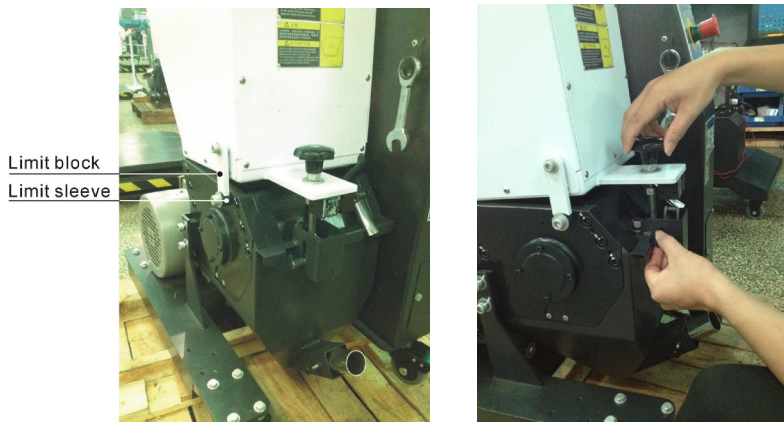

Picture 4-8: Close the Feed Box 1

- 2) When the star screw is twisted 1/4 inside the safety-switch plate, hold the feed box with right hand, left hand to push the limit block and put down the feed box slowly. Right hand continuously to twist the star screw till it is tightened up.

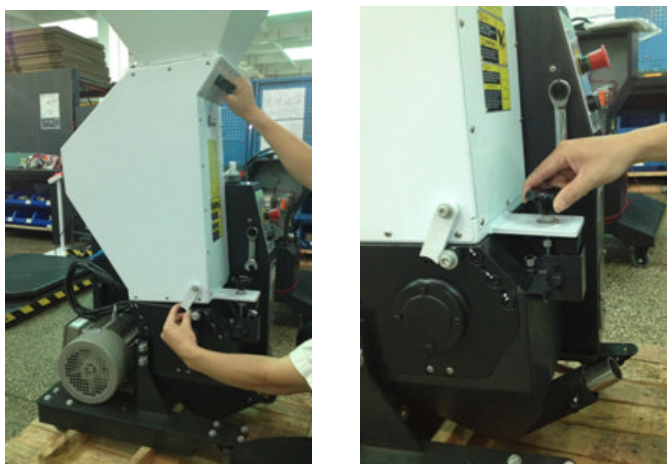

Picture 4-9: Close the Feed Box 2

#### 4.4.2 Close the Feed Box

- 1) Check to ensure there is no powder left in the interface or corners.
- 2) Close the feed box forwardly.
- 3) Lock up the star screw and fix the feed box.



Picture 4-10: Close the feed box

#### 4.4.3 Shut up the Storage Box



Note!

Before closing, clean the interface surface.

Be careful!

Don't get squeezed and injured.

- 1) Check no powder or leftover material around the cutting chamber, screen and screen frame; timely remove them if any.
- 2) Mount the screen and lock its star screw tightly.
- 3) Mount the storage box and lock its star screw tightly.



Picture 4-11: Shut up the Screen and Screen Frame

## 4.5 Blades Installation Adjusting (SG-20N)

All the cutters, including rotating blades and fixed blades, can be adjusted within clamp outside the machine.

Put all the cutters including rotating blades and fixed blades into clamp, adjusting its adjusting screw until the screw reach the clamp.

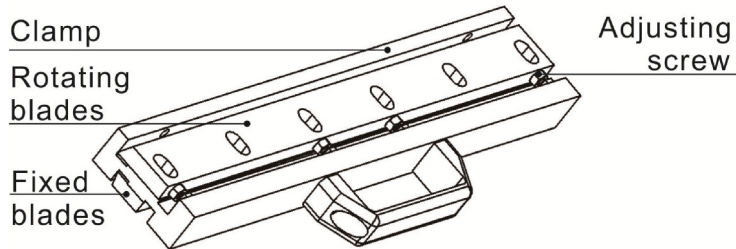

Picture 4-12: Blades Installation Adjusting (SG-20N)



## 5. Trouble-shooting

### 5.1 Granulator Can Not Work

- 1) Check if the emergency stop has not been reset. If not, rotate the Button clockwise to reset it.
- 2) Check whether the door is closed. If not, the machine could not be started.
- 3) Check if the feed box is completely closed. If not, the machine could not be started. Then, check the lockup clip after opening the door.
- 4) Check the motor's overload protector. The overload protector in the electrical control box will work if the motor overloads. Test key (A) turn left, press "Reset" key (B) to reset it. Before startup again, check whether there is any powder in the granulator.
- 5) Check the overload protector of the feeding blower's motor. If the feeding blower does not run, the granulator cannot run either. Check the motor protector in the electric control box. If it is closed, the switch will be in "0" positions. Reset it to "1" position, check whether there is any material residue, then re-start the machine. Test key (A) turn to left, press "Reset" key (B) to reset.
- 6) Check the space between blades. The stop will happen or the motor overload protector will work if the blade is very blunt or the space between blades is not correct. The motor overload protector will trip.

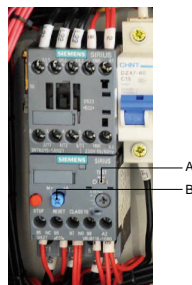

### 5.2 Stop Due to Other Reasons

Connection failure or looseness of safety switch or limit switch can also result in operation failure.



Note!

Do not disconnect to safety switch or control switch.

## 6. Maintenance and Repair

### 6.1 Repair

All the repair must be done by professionals to avoid damage to machine and harm to human body.

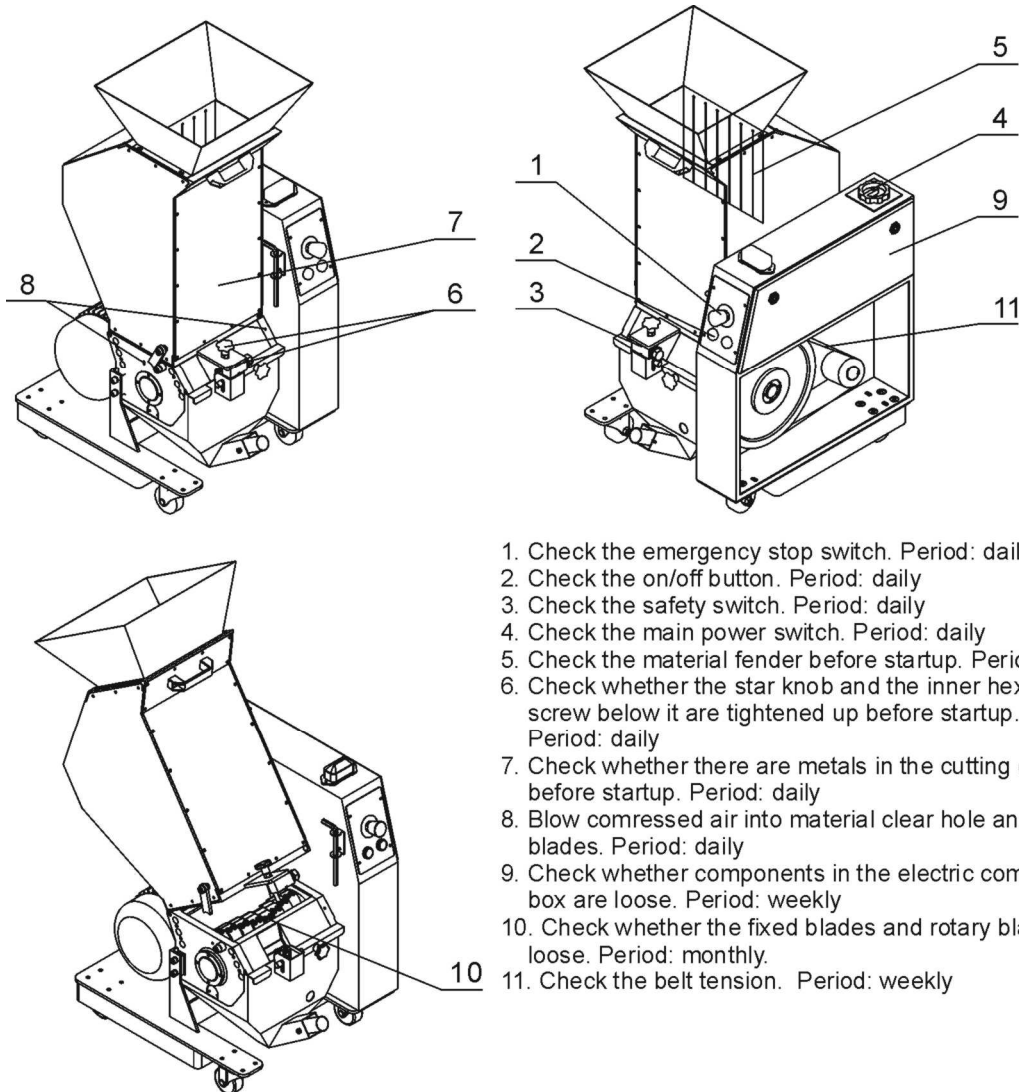

1. Check the emergency stop switch. Period: daily
2. Check the on/off button. Period: daily
3. Check the safety switch. Period: daily
4. Check the main power switch. Period: daily
5. Check the material fender before startup. Period: daily
6. Check whether the star knob and the inner hexagon screw below it are tightened up before startup. Period: daily
7. Check whether there are metals in the cutting chamber before startup. Period: daily
8. Blow compressed air into material clear hole and rotate blades. Period: daily
9. Check whether components in the electric components box are loose. Period: weekly
10. Check whether the fixed blades and rotary blades are loose. Period: monthly.
11. Check the belt tension. Period: weekly

#### 6.1.1 Replace the Blades



**CAUTION!**

Warning: Self-rotation exists due to non-balanced forces or unstable barycenter.



Wear gloves to avoid being cut and be careful of the sharp blades!

More details about replacing or maintaining the blades to see chapter 3.4.  
Inject screw thread fixing glue (light blue LOCTITE 243 recommended)  
to the fixing screw so to avoid slipping and tighten screws up.



Press Emergency Stop and Switch main power when Replacing Blades!



Wear gloves to avoid being cut and be careful of the sharp blades!

More details about replacing or maintaining the blades to see chapter 3.4.  
Inject screw thread fixing glue (light blue LOCTITE 243 recommended)  
to the fixing screw so to avoid slipping and tighten screws up.



Picture 6-1: Maintain and Clean Blades



**CAUTION!** To decrease the possibility of harm to other people, the replacement action must be conducted by oneself.



To avoid self-rotation, block the rotating blades with a thick wood block.

Be careful with the sharp blades.



Each time to replace the blade, the screw and insulation ring must be replaced also.

Before replacing the blades, open the feed box, remove the storage box, screen and screen frame.

## 1) Remove the fixed blades



### CAUTION!

To avoid self rotation, block the rotating blade with a thick wood block.

- 1) Remove the screws and insulation rings.
- 2) Remove the fixed blade.
- 3) Clean the installation surface of the blades.

## 2) Remove the rotating blades

1. Loosen and remove the hexagon socket cap screw.
2. Clean the whole rotating blades and cutting chamber.



### CAUTION!

Press the pressing block and blade when you remove the last screw.

## 3) Install the blades

Clean carefully the fixed blades and rotating blades and then install them.



### CAUTION!

Each time to replace the blade, the screw and insulation ring must be replaced also.

Install the back fixed blades then the front fixed blades, finally the rotating blades. More details about replacing or maintaining the blades to see chapter 3.4.

## 4) Check the blades

Turn around the blade rest till all the blades can rotate freely.

## 6.1.2 Transmission

### 1. Daily Maintenance of V Belts

Transmission belts are fixed according to motor power.

#### 1) Check the V belts

Check toothed belts' tensility after a full-load operation for 20-30 hours. And then check its abrasion condition monthly.

2) Check V belts' tensility every 6 months.

Remove the upper panel in the back end of the granulator.

Rotate the V belts for several circles to see if there is any damage.



**CAUTION!**

Check the belt tension, and adjust it if necessary. Check the belt tension by applying the force. Press the force (150N) in the middle of the pulley and measure its offset (The offset distance is determined by the motor power and frequency. See the following Table for specific specifications) at the same time:

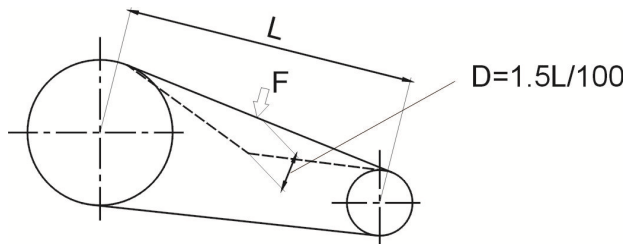

Picture 6-2: Transmission Belt Maintenance Diagram

Table 6-1: Transmission Belt Maintenance Table

| Hole Diameter (mm)          | 1.5kW/2.2kW | 3.0kW | 4kW   |
|-----------------------------|-------------|-------|-------|
| New belt                    | 15mm        | 15mm  | 15mm  |
| Old belt( every six months) | 19mm        | 19mm  | 19mm  |
| Motor 60Hz                  | 1.5kW/2.2kW | 3.0kW | 4.0kW |
| New belt                    | 18mm        | 18mm  | 18mm  |
| Old belt( every six months) | 23mm        | 23mm  | 23mm  |

**6.1.3 Adjustments of V Belts**

1) Take down the side plate on the control box that is located on the right side of the machine.

2) Take out the storage box; loose the position adjusting screws of the motor.



Picture 6-3: Adjustments of V Belts 1

- 3) The tension of the belt could be altered by adjusting the distance between motor and driving wheel. Tighten the screws after you finished the adjustment.



Picture 6-4: Adjustments of V Belts 2

- 4) Recheck the belts' tensility after a full-load operation for 20-30 hours.

## 6.2 Maintenance

When carrying out maintenance, ensure that there is no material left in the granulator.



### CAUTION!

All stuff concerning repair must be conducted by professionals to avoid damage or harm to human body.

#### 6.2.1 Daily check

- 1) There is rubber shutter in the feed box. If the rubber shutter is damaged, replace it immediately. Otherwise the fragment of the shutter will damage the blades in the cutting chamber and besides that, it will cause personal injury as it makes the grinded material shoot out during granulating.
- 2) Check whether the emergency stop works properly. Start the machine and then stop it via emergency stop. Rotate the button anti-clockwise to reset the emergency stop.
- 3) Check main power if Switches work normally.
- 4) Check star screw, safety screw is part of granulator' safety system, its length is pre-designed, when the screw is loosen, the granulator will stop working so to protect the machine. The thread length of the safety screw is 85 mm, damaged screw needs to be replaced by a new one.

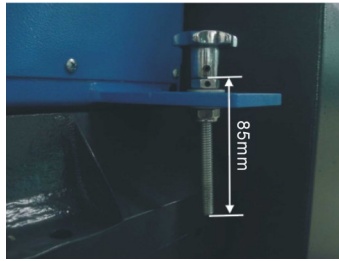

Picture 6-5: Star Screw

### 6.2.2 Weekly Check

- 1) Check the power wire to see whether there is any damage. If so, replace it immediately.
- 2) Check the safety switch.

### 6.2.3 Monthly Check

- 1) Check the motor operation.
- 2) Check the belt's tensility every 6 months. See "Transmission" for details.

## 6.3 Cleaning



Caution:

Cutting blades are very sharp, extreme caution must be used when working on an open cutting chamber.

- 1) Check the cutting chamber is clear before stopping the granulator.
- 2) Switch of the main power
- 3) Cleanning plate of the feed box with dust-collecting machine.
- 4) Cleaning external surface of the feed box.
- 5) Open the feed box.
- 6) Clean all internal surfaces of the feed box.
- 6) Remove and clean the material collection box.
- 8) Clean screen and screen bracket.
- 9) Outer and inner of cutting chamber.
- 10) Cleaning belt pulleys with shinning dust-removing agent.
- 11) Blow the Clearance hole in the side plate of cutting chamber with pressed air (A), and rotate blades to remove cutting material inside bearing block.

Suggest Cleaning once a day.

Gas hole A

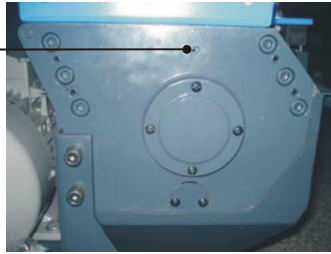

Picture 6-6: Clearing the Dust Collection Chambers



Caution!

Cover safety switch with a protective sleeve to avoid any dusts.

## 6.4 Installation of Bearing and Blade Rest

- 1) Put oil seal and bearing orderly into bearing pedestal.

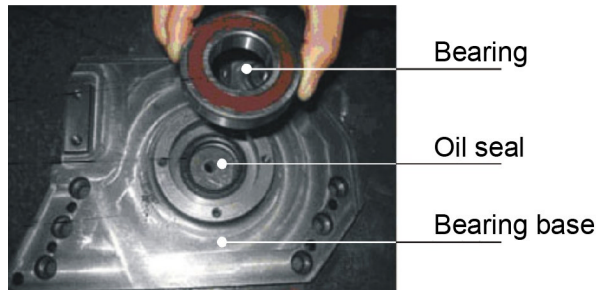

Picture 6-7: Installation of Bearing and Blade Rest 1

- 2) Insert blade shaft vertically into blade rest, let hydraulic machine compress it tightly.
- 3) Mount shaft sleeve and material flap orderly into the main shaft and to make the material flap completely match shaft sleeve and blade rest.
- 4) Mount bearing pedestal onto the blade rest and use hydraulic machine to press tight.

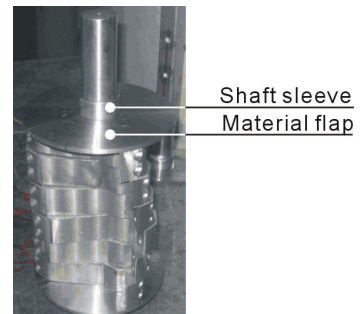
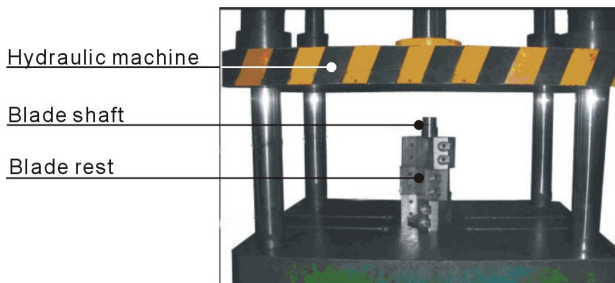



Picture 6-8: Installation of Bearing and Blade Rest 2

5) Put the installed blade rest (see figure 1) into the cutting chamber.

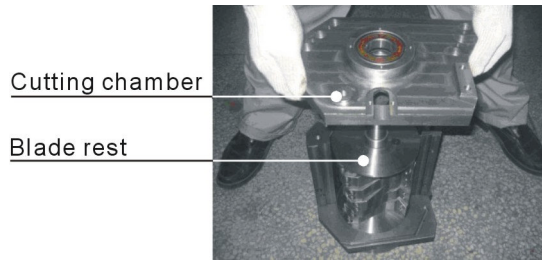

Picture 6-9: Installation of Bearing and Blade Rest 3

6) Install the bearing cover and tighten it by screw.

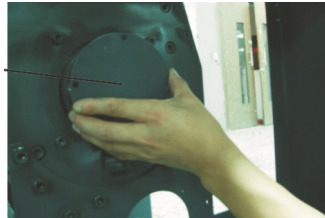

Picture 6-10: Installation of Bearing and Blade Rest 4



Note!

Apply grease on the bearing and bearing pedestal.

Table 6-2: Attached Form, Cutters and Other Fixing Screw Torque

| Thread size       | M10  | M12  | M14 | M16  | M18  | M20 | M22 | M24 |
|-------------------|------|------|-----|------|------|-----|-----|-----|
| Axial force (N)   | 23.8 | 34.5 | 47  | 65.5 | 78.5 | 103 | 129 | 149 |
| Fixing torque(Nm) | 50   | 86   | 135 | 215  | 290  | 420 | 570 | 730 |

## 6.5 Installation of Belt and Belt Pulley

- 1) Install one end of the main shaft into the guide hole of the blade shaft, then tighten the screw with correct torque (84Nm) after matching the hole on the housing case, by this way to fix the right bearing block on the housing case.



Picture 6-11: Installation of Belt and Belt Pulley 1

- 2) Set taper sleeve into big belt pulley first before putting the big belt pulley on main shaft



Picture 6-12: Installation of Belt and Belt Pulley 2

- 3) Fit big belt pulley and taper sleeve right on main shaft.



Picture 6-13: Installation of Belt and Belt Pulley 3

- 4) Tighten up the two screws on taper sleeve (torque value is 90Nm). Before tightening, the needle of dial indicator contacts the edge of belt pulley. As the pulley is turned, tighten the lock screw as indicated by the dial indicator (its range is 0.01-0.03mm) to enable the lock rings are fully engaged between the pulley and the blade shaft.

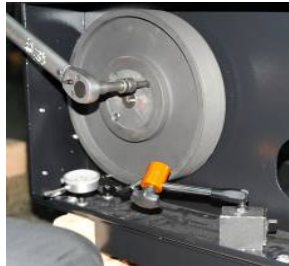

Picture 6-14: Installation of Belt and Belt Pulley 4

- 5) Put the small belt pulley on the motor to allow the key of motor corresponding with the key groove on the belt pulley. Then tighten the two screws on the taper sleeve (torque value is 20Nm).



Picture 6-15: Installation of Belt and Belt Pulley 5

- 6) Put the belt on the blade shaft belt pulley and motor belt pulley. The tooth of belt shall correspond with synchroal gear. Turn the blade shaft and motor shaft to enable the tooth of belt fully corresponds with the pulley tooth under totally even stress.



Picture 6-16: Installation of Belt and Belt Pulley 6



Note!

Apply grease on the bearing and bearing pedestal. Apply applicable torque to tighten the key and the screw on the shaft.

- 7) Put the straight edge closely against the surface of the blade shaft belt pulley; then observe the spacing between two pulleys and the straight edge and adjust the motor belt pulley at the same time to allow the surface of the motor belt pulley parallel with it.



Picture 6-17: Installation of Belt and Belt Pulley 7

- 8) Adjust the adjusting screws at both ends of motor fixed plate by the wrench until two belt pulleys are parallel, to keep the motor flat and the belt tensioned. Use the correct torque (84Nm) until the pulley moves to the place where the belt is balanced.



Picture 6-18: Installation of Belt and Belt Pulley 8

- 9) Tighten the fix screws of motor at four corners to allow the motor fixed on the base plate of granulator.

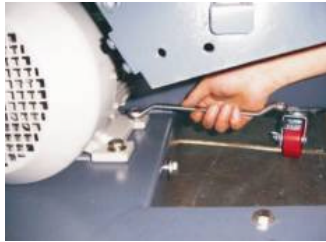

Picture 6-19: Installation of Belt and Belt Pulley 9



Be careful!

The cutting blade rest shall be put stably. Self turning of cutting tool shall be prevented prior to installation. At the time of operating, hand shall stay away from the cutting tool to avoid bodily injury.

## 6.6 Installation of Feed Box and Feed Port

- 1) Lift up the feed box to fix it onto the cutting chamber. Clean up impurities on the contacting interface, thus use fixing rod to fix it onto the cutting chamber.

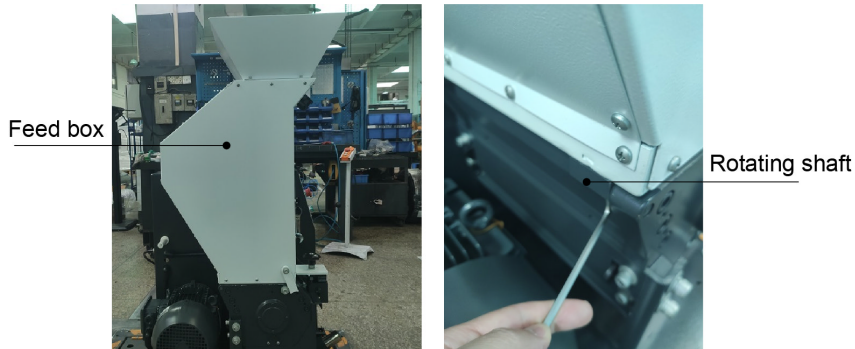

Picture 6-20: Installation of Feed Box, Feed Port and Storage Hopper 1

- 2) Hold the feed port, and insert it into the feed box.

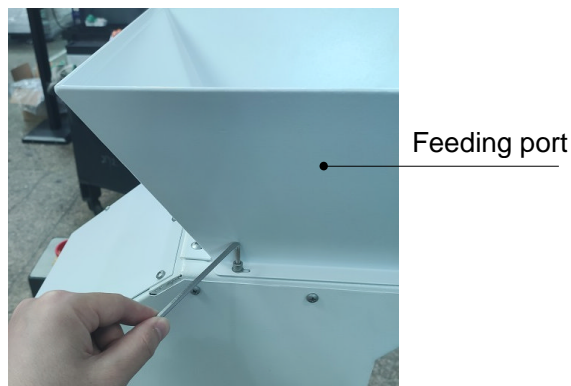

Picture 6-21: Installation of Feed Box, Feed Port and Storage Hopper 2



Attention!

Lock each screw with right torque (5.9Nm).

## 6.7 Installation of Screen and Screen Frame

- 1) Put screen on to the screen frame and make its notch tallies with collar on the screen frame.

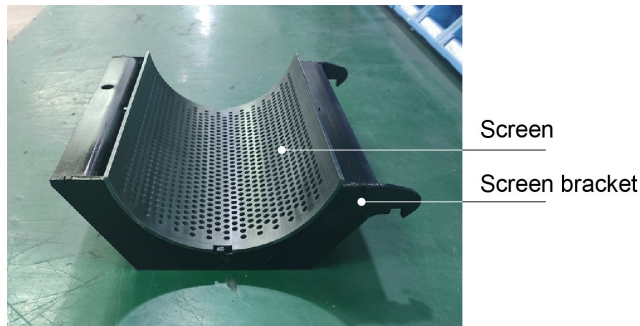

Picture 6-22: Installation of Screen and Screen Frame 1

- 3) Hold the screen bracket by hands, align the fixing hooks at both ends of the screen bracket with the square groove on it, and push the fixing hooks into the square groove to hang the screen bracket on machine rack (As shown in the direction of arrows).

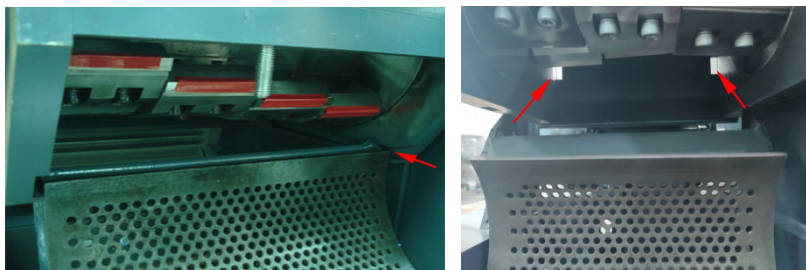

Picture 6-23: Installation of Screen Frame 1

- 3) Hold the screen frame and move it along the groove as the direction arrow shows until the stationary axis reach the groove end.

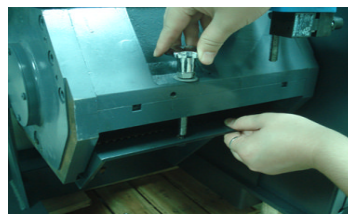

Picture 6-24: Installation of Screen Frame 2

## 6.8 Installation of Material Collection Box.

- 1) The storage box moves in the direction indicated by the arrow in the Picture below:



Picture 6-25:Installation of Material Collection Box 1

- 2) The storage box is as the arrow shown in the Picture below. First move it upward, and then pull it back to make 2 (folding edge of storage box) hang on 1 (folding edge of the storage box's hanging plate).

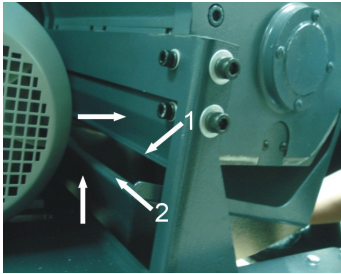

Picture 6-26:Installation of Material Collection Box 2

- 3) The after installation state of material collection box is showed in the picture below.



Picture 6-27:Installation of Material Collection Box 3

- 4) Fasten the star knob and finish the installation. See picture below.



Picture 6-28:Installation of Material Collection Box 4



## 6.9 Dismantlement of Cutting Chamber Bearing

### 6.9.1 Cutting Chamber Dismantlement

- 1) First, the cutting chamber should be taken out from the machine and put onto the table, then dismantle the rotating and fixed blades.



Picture 6-29: Step 1 of Cutting Chamber Dismantlement

- 2) Dismantle the screws fixed on the left and right side plate separately;



Picture 6-30: Step 2 of Cutting Chamber Dismantlement

- 3) Knock the left and right side plate of cutting chamber with the copper stick;



Picture 6-31: Step 3 of Cutting Chamber Dismantlement

- 4) The cutting chamber is apart by the external force, the cutting chamber is disassembled.

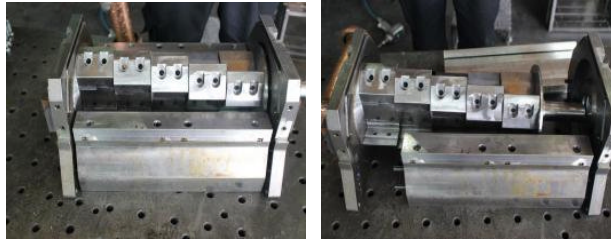

Picture 6-32: Step 4 of Cutting Chamber Dismantlement

### 6.9.2 Take out the blade-rest shaft

- 1) Put the side plate with blade-rest shaft on the supporting frame, as to take out the shaft conveniently.



Picture 6-33: Step 1 to Take Out the Blade-rest Shaft

- 2) Put the fitted iron rod on the blade-rest shaft, and knock the shaft from the outside.



Picture 6-34: Step 2 to Take Out the Blade-rest Shaft

- 3) Take out the blade-rest shaft.



Picture 6-35: Step 3 to Take Out the Blade-rest Shaft

### 6.9.3 Take out the bearing

- 1) Put the left/right side palte with the bearing on the pad, as to take out the bearing conveniently.

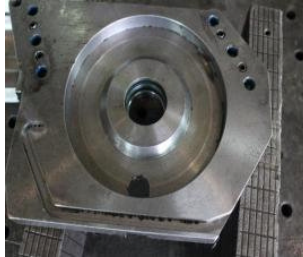

Picture 6-36: Step 1 to Take Out the Bearing

- 2) Put the fitted iron rod on the bearing, and knock the bearing from the outside.



Picture 6-37: Step 2 to Take Out the Bearing

- 3) Take out the bearing.

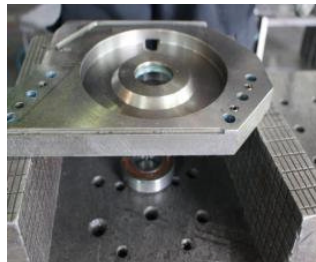

Picture 6-38: Step 3 to Take Out the Bearing

## 6.10 Maintenance Schedule

### 6.10.1 About the Machine

Model \_\_\_\_\_ SN \_\_\_\_\_ Manufacture date \_\_\_\_\_

Voltage \_\_\_\_\_  $\Phi$  \_\_\_\_\_ V Frequency \_\_\_\_\_ Hz Power \_\_\_\_\_ kW

### 6.10.2 Check After Installation

- Check if pipe connections are firmly locked by clips.
- Check the gap between fixed blade and rotating blade. (0.2mm).
- Check the rotating balance of the belt wheel.

#### Electrical Installation

- Voltage: \_\_\_\_\_ V \_\_\_\_\_ Hz
- Specs of the fuse: 1 Phase \_\_\_\_\_ A 3 Phase \_\_\_\_\_ A
- Check phase sequence of the power supply.
- Check the rotating direction of the conveying blower.

### 6.10.3 Daily Check

- Check main power switch.
- Check emergency stop button.
- Check start / stop button.
- Check material check plate (strip) is perfect or not.
- Check whether emergency stop and safety switch works normally.
- Clean screen and feeding hopper.
- Check whether start, stop and power switches are normal.

### 6.10.4 Weekly Check

- Check all the electrical cables.
- Check if there are loose connections of electrical components.
- Check blade condition.
- Check whether set screws in fixed and rotate blades are under looseness.
- Check if there is abnormal noise, vibration and heat in reduction gear.
- Check the cracking window

### 6.10.5 Monthly Check

- Check the status of the belt.

- Check the overload protection function of the motor.
- Check motor reversed running function.
- Check the tightness of the blades.
- Check whether clamp ring of pulley is fastened.
- Check belt tension.

#### 6.10.6 Check Half-yearly or Every 1000 Running Hours

- Check or replace lubrication for gear motor.
- Check lubrication of bearing.
- Check coupling.
- Evaluation of the machine condition.

#### 6.10.7 3 year Checking

- PC board renewal.
- No fuse breaker renewal.