

SPG

Pump Group

Date: Aug, 2018

Version: Ver.A (English)



Contents

1. General Description	5
1.1 Coding Principle	6
1.2 Features	6
1.3 Technical Specifications.....	8
1.4 Characteristic Relation of Frequency Conversion Control.....	10
1.5 Safety Regulations	11
1.5.1 Safety Signs and Labels	11
1.5.2 Important notice for lifting and transporation safety	12
1.5.3 Notice for Installation	13
1.5.4 Notice for Operation	13
1.5.5 Notice for Maintenance	14
1.6 Exemption Clause	15
2. Structural Features and Working Principle	16
2.1 Working Principle	16
3. Installation and Debugging.....	18
3.1 Electrical connection	18
3.2 Pipeline Connection	19
3.2.1 Pipeline.....	19
3.2.2 Anti-freezing protection.....	20
4. Use and Operation.....	22
4.1 Operation Panel	22
4.2 Technical parameters.....	22
4.3 Control	23
4.4 Menu Description	24
4.4.1 Menu Seletion.....	25
4.4.2 Startup	25
4.4.3 Alarm	26
4.4.3.1 "Alarm" key to check the alarm	26
4.4.3.2 Alarm reset.....	26
4.4.3.3 Alarm log.....	27

5. Maintenance	28
6. Equipment Discarding	28

Table index

Table 1-1: Technical Specifications	9
Table 4-1: Panel Key Table	22
Table 6-1: Alarm Code Parameter Table	29

Picture index

Picture 1-1: Dimensions.....	8
Picture 1-2: Curve Diagram	10
Picture 2-1: Working Principle	16
Picture 2-1: Operation Panel	22

1. General Description



Please read this manual carefully before using this machine in order to operate correctly against any damage caused due to improper operation.

During most pump service periods, water or water and ethylene glycol mixture is the substance used in the pump, so it's simply called "water" afterwards. The (pumping-exhaust) liquid should match the materials that used: we must seriously consider before purchasing or installing the pump group. When connected with other machines, follow the instructions of other machinery manufacturers strictly.

It is applicable to centralized constant-pressure water supplying system that is suitable for large power, variable flow and frequent start occasions, which features high-efficient system and obvious energy-saving effect. It also can be used for reforming the water tank and other forms of water supply.



1.1 Coding Principle

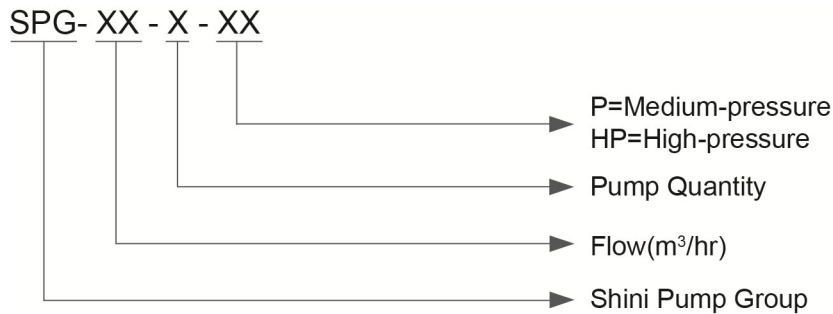

1.2 Features

- Adopt frequency conversion control with obvious energy-saving effect;
- Auto/manual switching function ensures the stability of the water system;
- Independently researched and developed advanced controller and frequency-conversion shift, precisely ensuring constant pressure for water supply according to water consumption variation;
- Equipped with RS485 remote monitoring function;
- When the water pump fails, the system will start the next normal pump operation automatically;
- Non-impact of pipe network pressure supplies constant pressure for water supply;
- Soft-start of water pump circling, stable start and stop prevent power grid from impacting by starting current;
- First-start and first-stop operation achieves organized working of water pump to prolong the service life of the water pump.
- Modular and innovative design concept enables the supplying of independent pump that with two or several pumps to achieve any flow and ensure continuous operation.
- Available to cover all the flows and pressures required by the industrial process;

All service work should be carried out by a person with technical training or corresponding professional experience. The manual contains instructions for both handling and servicing. Chapter 6, which contains service instructions intended for service engineers. Other chapters contain instructions for the daily operator.

Any modifications of the machine must be approved by SHINI in order to avoid personal injury and damage to machine. We shall not be liable for any damage caused by unauthorized change of the machine.

Our company provides excellent after-sales service. Should you have any problem during using the machine, please contact the company or the local vendor.

Headquarter and Taipei factory:

Tel: (886) 2 2680 9119

Shini Plastics Technologies (Dongguan), Inc:

Tel: (86) 769 8111 6600

Shini Plastics Technologies India Pvt.Ltd.:

Tel: (91) 250 3021 166

1.3 Technical Specifications

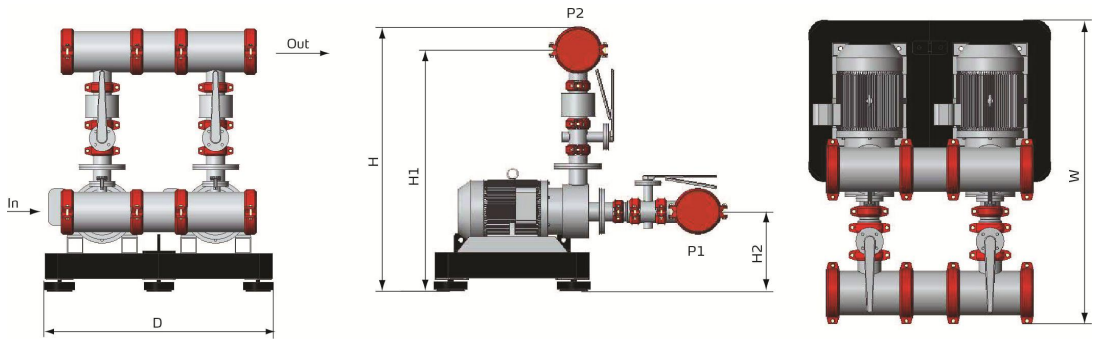

Model	SPG-25		SPG-45		SPG-90			
	-2	-3	-4	-2	-3	-4		
Dimension	(N-1)×906		(N-1)×1096		(N-1)×1278			
D(mm)	1104		1359		1533			
H(mm)	1034		1273		1424			
H1(mm)	315		385		405			
H2(mm)	1053		1249		1468			
W(mm)	DN125		DN150	DN150	DN200	DN200	DN250	DN250
P 1	DN125	DN150	DN150	DN200	DN200	DN250	DN250	
P 2	DN125	DN150	DN150	DN200	DN200	DN250	DN250	
A(mm)	2110		2110		2110			
B(mm)	1880		1880		1880			
C(mm)	700		700		700			
D(mm)	400		400		400			
Weight (kg)	N×175		N×261		N×340			

Note: The weight does not contain the weight of electrical control cabinet, N stands for the number of pumps.

Picture 1-1: Dimensions

Table 1-1: Technical Specifications

Model		SPG-25			SPG-45			SPG-90		
		-2	-3	-4	-2	-3	-4	-2	-3	-4
Pump Qty.		2	3	4	2	3	4	2	3	4
Rated Flow (m ³ /hr)		25×2	25×3	25×4	45×2	45×3	45×4	90×2	90×3	90×4
Rated Pressure (bar)		P=3.4/HP=5.0			P=3.2/HP=5.6			P=3.5/HP=5.1		
Power	-P(kW)	5.5×2	5.5×3	5.5×4	7.5×2	7.5×3	7.5×4	15×2	15×3	15×4
	-HP(kW)	7.5×2	7.5×3	7.5×4	15×2	15×3	15×4	22×2	22×3	22×4
Pipe	Water Inlet(DN)	DN125		DN150	DN150		DN200	DN200		DN250
Dia.	Water Outlet(DN)	DN125		DN150	DN150		DN200	DN200		DN250
Protector	Pump	Overload relay, low pressure/high pressure protection								
Devices	Water Loop	Water shortage protection *								
Noise dB (A)		75/80			80/85			85/90		
Power		3Φ, 400VAC, 50HZ								

Note: 1) Customation is available.

We reserve the right to change specifications without prior notice.

- 2) The allowable deviation of pressure and flow is 5%.
- 3) *Water shortage protection, the flow switch should be equipped in system by the customer, and the point location is only reserved in the control box.
- 4) Water temp.: 2~70°C
- 5) The flow and pressure will be different when it uses the ethylene glycol. Please contact our sales person for confirmation.
- 6) As to improve the performance and reliability, it is recommended to equip the water pump units, such as one factory needs 90m³/h and working pressure is XXbar, which should select SPG-45-3-X or SPG-90-2-X.

1.4 Characteristic Relation of Frequency Conversion Control

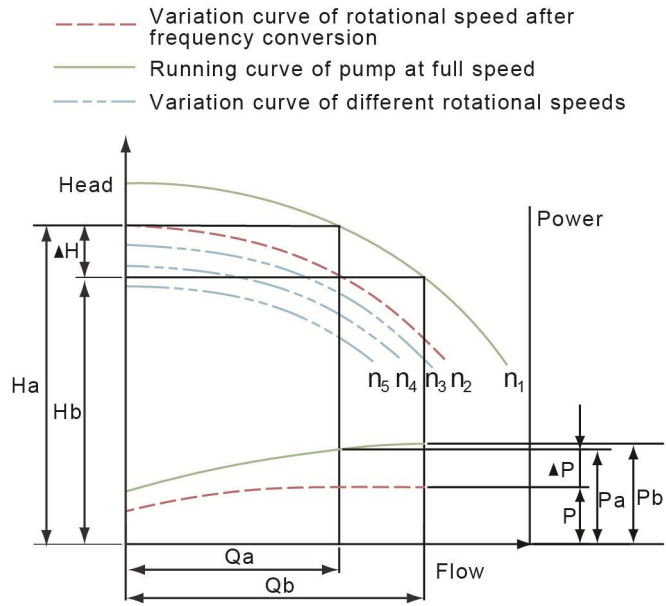



Picture 1-2: Curve Diagram







1.5 Safety Regulations

Machine safety can be ensured as long as the installation, debugging and usage are processed according to the manual. So, the personnel who install, use or maintain the equipment must read through this manual carefully.

When the machine is disconnected with the power, it must be maintained by experienced and trained personnel familiar with the precautions. When operating or maintaining the equipment or its accessories, relevant personnel should ensure safe operation, and read through relevant safety and health instructions. Many accidents occur due to the lack of reference to basic safety precautions and guidelines during equipment operation and maintenance. Accidents usually can be avoided if potential hazards can be aware. The equipment user must ensure that all persons involved in equipment operation and accessories maintenance have read through and understood all warnings, early warnings, prohibitions and instructions in this manual and equipment. Incorrect use or maintenance of equipment and its accessories is very dangerous and may lead to casualties. The operation of the equipment and its ancillary equipment is allowed only when the relevant personnel have clearly read and understood the opening and operating instructions of this manual. The equipment and its accessories can only be operated by relevant personnel who have clearly read and understood the startup and operation instructions of this manual. It is impossible to foresee all possible potential dangers. So the safety instructions in this manual are not completely thorough. If the operator uses the operational procedure, equipment or working method without special recommendations, make sure that no damage or danger is caused to the equipment and its accessories, and ensure the safety of personnel and property.

1.5.1 Safety Signs and Labels

	<p>For procedures or specifications for reference, if it hasn't been implemented correctly, it will lead to serious injury or even death.</p>
	<p>For procedures or specifications for reference, if it hasn't been implemented correctly, it will lead to serious injury or even death.</p>

	<p>For procedures or specifications for reference, if it hasn't been implemented correctly, it will lead to serious injury or even death.</p>
	<p>Danger: contact</p>
	<p>Danger: high temperature surface</p>
	<p>Protective footwear must be put on.</p>
	<p>Protective gloves must be put on.</p>
	<p>Facemasket must be put on.</p>
	<p>Respiratory protection device must be put on.</p>

1.5.2 Important notice for lifting and transporation safety

If there's any doubt, don't use the equipment and contact Shini technical service department. Equipment packaging must be treated according to standard waste disposal regulations.

When lifting device is used to hoist heavy equipment, dangerous situations should be avoided. Check and confirm that all chains, hooks, rings and belts have been overhauled with enough capacity. All chains, hooks, rings and belts shall be tested and inspected in accordance with safety regulations at the installation site. Besides, cables, chains or ropes can not be directly connected to lifting lugs. Rings or hooks should be mounted in correct postions to make sure there's no too tight bending caused by the hoisting cable. Use steel bars to avoid side load of

hook and lifting lugs. Pump equipment can also be transported by forklift. All operations must strictly follow the following illustration.



1.5.3 Notice for Installation

The equipment installation must comply with the standard safety and health regulations.

When connecting the power, check and confirm that the voltage and frequency on the nameplate match the power supply, and the main circuit meets the maximum power requirements of the equipment. Check if the voltage and frequency on nameplate match the power supply, and if the main circuit meets the maximum power requirements of the equipment. As the decrease of water system pipe pressure, the lift will be lower than the pump parameters. Therefore, when installing the pump group, it's necessary to correctly measure the pipeline of water pipe system. Incorrect measurement will greatly reduce the lift and flow of pump group installed on the equipment. Therefore, it's necessary to strictly follow the instructions of the designer to make proper measurement of the workshop. Shini Company is not responsible for its performance degradation or any trouble due to improper installation.

1.5.4 Notice for Operation

Equipment operation must be done by experienced personnel under the guidance of qualified supervisors. Don't remove or damage the safety equipment, protective equipment or insulating materials on equipment or ancillary facilities. All electrical connections should comply with relevant regulations, and equipment and ancillary

facilities should be connected to the ground, with short circuit and overload protection.

When the equipment starts, the circuit voltage will reach the dangerous level. Therefore, it's necessary to carry out circuit-related work and take strict measures. When the circuit circulates, don't open the cabinet locking the electrical equipment unless experienced personnel are required to carry out the necessary tests, measurements or settings.

This work must be carried out by qualified personnel using appropriate device and wearing electrical protection device. Equipment operators must ensure that the liquid circulating in the system where the pump group is installed doesn't contain grindings or chemical substances that damage the pump. **The electronic control box is equipped with local and remote controlled selectors. Local control can only be used by qualified personnel during the startup phase or when the system is full of water measurement and testing.**

1.5.5 Notice for Maintenance

Equipment maintenance, overhaul and minor repairs must be conducted by experienced personnel under the guidance of qualified supervisors. If it's necessary to exclude waste, ensure it won't pollute the water pipe, and no air pollution caused by material burning. Only use appropriate environmental protection storage methods. If you need to replace spare parts, you can only use certified accessories. Record the work done on the equipment or its ancillary facilities. The frequency and nature of maintenance work can reflect abnormal operation that should be corrected. Ensure that all instructions for operation and maintenance are strictly implemented, including all accessories, and the entire unit of safety equipment operates in accordance with good procedures. Re-start the equipment after electrical connection or power supplier operation, and check the direction of motor running. All protective facilities must be installed back after the completion of maintenance and service works. The manufacturer shall not be liable for any loss of personnel or property caused by failure to comply with safety regulations.

The equipment can be packed by cardboard, cartons, cages, plywood and protective plastic cloth to transport to the destination. If the equipment needs to be

transported later, please don't remove the protective packaging material. Please follow local specifications of the installation site when handling packing materials.

1.6 Exemption Clause

The following statements clarify the responsibilities and regulations born by any buyer or user who purchases products and accessories from Shini (including employees and agents).

Shini is exempted from liability for any costs, fees, claims and losses caused by reasons below:

1. Any careless or man-made installations, operation and maintenances upon machines without referring to the Manual prior to machine using.
2. Any incidents beyond human reasonable controls, which include man-made vicious or deliberate damages or abnormal power, and machine faults caused by irresistible natural disasters including fire, flood, storm and earthquake.
3. Any operational actions that are not authorized by Shini upon machine, including adding or replacing accessories, dismantling, delivering or repairing.
4. Employing consumables or oil media that are not appointed by Shini.

2. Structural Features and Working Principle

2.1 Working Principle

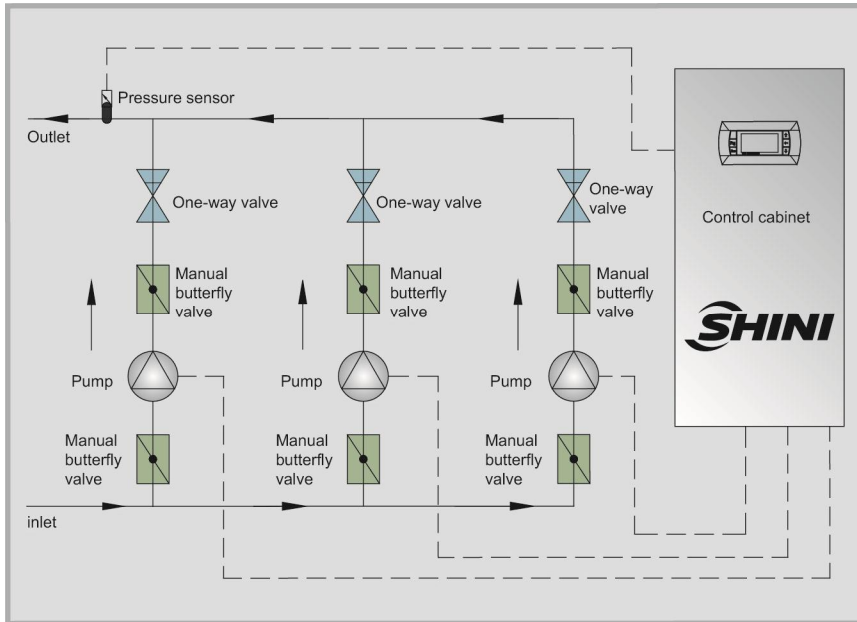

Picture 2-1: Working Principle

After SPG series of pumping unit start, the pressure sensor detects the outlet pressure to compare the detection value and setting value. If the setting value is greater than the detection value, the controller will select the water pump with shortest frequency-conversion loading time (The single pump of controller has run time cumulative function) for continuous loading. During the process, if the setting value is equal to the detection value, the controlling frequency converter will run at a constant fixed rotation speed with constant water supply. When it loads to full frequency (50HZ), if the setting value is still greater than the detection value, the water pump controlled by frequency-conversion will turn to power-frequency operation. The controller will start next pump with short run time in frequency-conversion via frequency conversion shift function to repeat above loading process till the setting value is equal to the detection value.

In constant-pressure water supplying, if the water flow reduces, and the detection value is greater than setting value, the controller will decrease the vibrational frequency of the water pump. When the pump of frequency conversion decreased to one frequency (normally is 30HZ), if the detection value is still greater than the

setting value, it stops the pump with longest running time. Then, the frequency converter will re-control the pump frequency till the detection value is equal to the setting value, with constant pressure for water supplying of frequency conversion.

3. Installation and Debugging

Following operations must be carried out by experienced operators.

3.1 Electrical connection

Check whether the supply voltage and frequency on wiring diagram are consistent with the voltage frequency on the equipment nameplate. Ensure power access follows local code and rules of installation site. The cable should meet the maximum load of the pump group (see wiring diagram). If the equipment is installed outdoors, the protection level of cable input circuit connected to main power supply is at least IP54. If the equipment is installed indoors, the protection level IP2X or IPXXB or above is sufficient.

The starting point of power cable must be equipped with the equipment with following performances:

- 1) Cable overcurrent protection
- 2) If the short-circuit current at the installation side is greater than 10 kA, the short circuit current (recommended protection refer to wiring diagram) is limited to the maximum 15kA according to fusing capability.
- 3) Indirect contact of protection equipment (electricity circuit and equipotential protective short circuit) should be automatically disconnected with the power according to IEC 364-HD 384-CEI 64-8 standard. To achieve this purpose, please use residual current operated protector (usually with 0.3A rated residual current).
- 4) Three phase power, and phase shortage protection. For circuit protection, please refer to the data given in the "technical parameter" section or the wiring diagram attached.

Before connecting to the main power supply, please check the following items:

The integrity of the electrical assembly should without signs of burnout or wear;

The max. interphase voltage imbalance should not exceed 3%.

Too high imbalances will damage the device.

Please refer to the following example to calculate the imbalance (take 3 phase 400V power voltage as the example):

Voltage L1, L2, L3 of three phase connection points are measured by the voltmeter.

Voltage L1 - L2 = 393V;

Voltage L2 - L3 = 401V;

Voltage L1 - L3 = 403V;

$$\text{Average voltage} = \frac{393 + 401 + 403}{3} = 399V ;$$

The max. voltage difference between phases is 399-393=6V;

Imbalance between the phases is $\frac{6}{399} \cdot 100 = 1.5\%$, it is acceptable as it lowers than 3%.

Warning: Machine warranty is not guaranteed if the power parameters are not in compliance with the regulations in this manual (invalid equipment warranty). This equipment must be connected to the ground effectively.

3.2 Pipeline Connection

3.2.1 Pipeline

The pipe diameter and model must be selected by unqualified personnel. Using a small diameter pipe will reduce the available flow / pressure.

As to reach the quality standard, please refer to the following Table in which the objects are purified water and common steel pipe. The pipe diameter pressure loss is about 0.4 bar, and the speed is within correct limit. The pressure loss is caused by elbow, contact and other system accessories.

Water Flowrate (cubic metre /hr)	Pipeline Straight Length (m)						
	10	20	30	40	60	80	100
10	DN40	DN40	DN40	DN40	DN40	DN65	DN65
20	DN50	DN50	DN65	DN65	DN65	DN65	DN80
30	DN65	DN65	DN65	DN65	DN65	DN65	DN80
40	DN80	DN80	DN80	DN80	DN100	DN100	DN100

50	DN80	DN80	DN80	DN100	DN100	DN100	DN100
60	DN100	DN100	DN100	DN100	DN100	DN100	DN125
70	DN100	DN100	DN100	DN100	DN100	DN125	DN125
80	DN100	DN100	DN100	DN100	DN125	DN125	DN125
90	DN100	DN100	DN125	DN125	DN125	DN125	DN125
100	DN125	DN125	DN125	DN125	DN125	DN125	DN125

3.2.2 Anti-freezing protection

Following situations need protection

- 1) If the water temp. is required below +5°C;
- 2) If the ambient temp. is required below +3°C.

It's necessary to add the ethylene glycol (or glycol propylene) in the water for anti-freezing protection. Ethylene glycol must contain corrosion inhibitors: Don't use the pure ethylene glycol! The lowest percentage of ethylene glycol should be 20%/22% of the total weight to prevent metal corrosion.

Ethylene glycol (%/cubic meter)	Ethylene glycol (%/Kg)	Freezing point (°C)
20	22	-8
25	27	-11
30	33	-14
35	38	-18
40	43	-23
45	48	-28
50	53	-33

Note: The use of water and ethylene glycol mixture can decrease the cooling capacity.

Glycol propylene (%/cubic meter)	Glycol propylene (%/Kg)	Freezing point (°C)
20	20.6	-6.5
25	25.8	-9
30	31	-11
35	36	-14.5
40	41.2	-18.5
45	46.4	-22.5
50	51.5	-26.5

Cooling capacity loss (%)	Ethylene glycol content (%)
2.0	20
3.0	30
3.5	35
4.0	40





4. Use and Operation

4.1 Operation Panel



Picture 4-1: Operation Panel

Table 4-1: Panel Key Table

Keys	Functions
 - Alarm	Display alarm list or fault manual reset of action.
Prg - Prg	Enter the menu
Esc - Esc	Return to upper screen
 - Up	Turn up the list or increase the value on displayer
 - Down	Turn down the list or decrease the value on displayer
 - Enter	Enter the selected sub-menu or confirm the set value.

Following figure displays the example of the main screen.

07/04/2017	Friday
10:58	
Water output pres.	4.0bar
Speed:	0rpm
	Keyboard shutdown

Inverter info.:	
Speed:	0pm
Output freq.:	0.0Hz
Current:	0.0A

Inverter info.:	
Torque	0.0%
Power	0.0AkW

Inverter info.:	
DC bus voltage:	0U
Output vol.:	0U

4.2 Technical parameters

- 1) Liquid temp. : +2°C-- +70°C.
- 2) Ambient temp. : -5°C-- +46°C.

- 3) Max. pump output pressure: 10 bar.
- 4) Min. system preload pressure: 1 bar
- 5) Operation life, flow and absorption power must be within rated current. Serious failure and damage may occur if it doesn't follow these rules.
- 6) Installation should be carried out in places that are confined or free from the weather condition. The warranty is not guaranteed if pump group installation, maintenance and operation essentials are not in compliance with the standard. The use of antifreeze must be allowed by Shini company (pump sealing problem).

4.3 Control

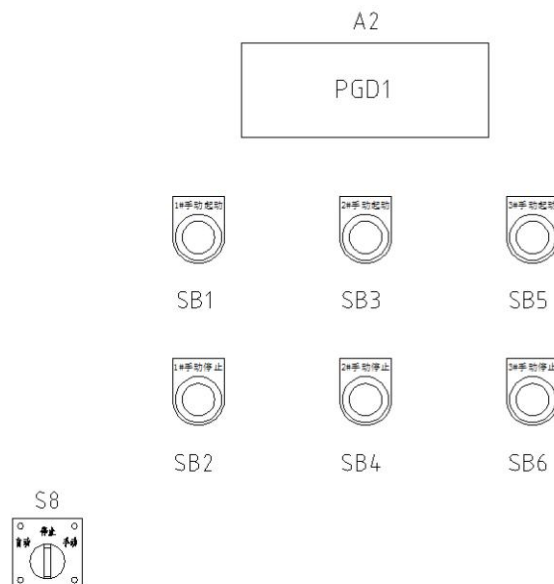

The description is as follows:

A2: User manual screen

SB1: 1# pump manual start button (with green indicator)

SB2: 1# pump manual stop button (black switch)

SB3: 2# pump manual start button (with green indicator)

SB4: 2# pump manual stop (black switch)

SB5: 3# pump manual start button (with green indicator)

SB6: 3# pump manual stop (black switch)

S8: Universal change switch

4.4 Menu Description

Except for the interface completed by default parameters, no matter what interface is displayed currently, it can press the Prg key to enter the main menu as below, the up and down key to select the sub-menu, and Enter key to access. Press the Esc key to return to previous menu till it connects the main interface.



→ Main menu

- A. On/Off
- B. Setup
- C. Clock/ time zone management
- D. Input and output
- E. History alarm
- F. Service → Services Menu
 - a. Language switch
 - b. Information
 - c. Working hours
 - d. BMS setup
 - e. Service setup → Service setup menu
 - a. Main. time setup
 - b. Probe sta.
 - c. User default / password
- G. Plant → Plant menu
 - a. Configuration
 - b. Input and output setting
 - c. Plant para. setting
 - d. Initialization

4.4.1 Menu Selection

The menu diagram is as follows:

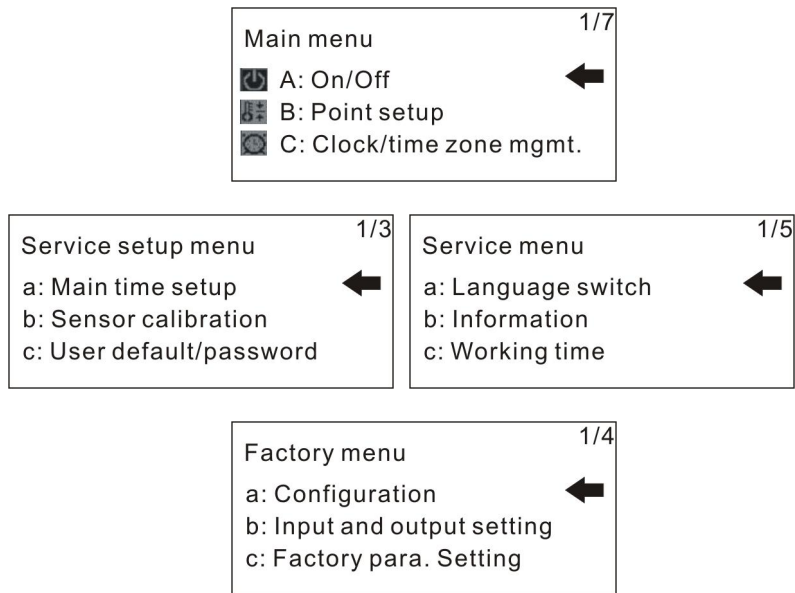



In each of above menus, press up and down key to select the sub-menus (menu in arrow position), and press the Enter key to access.

4.4.2 Startup

Start the pump to let the water circulate and gradually eliminate the air in the pipeline. Avoid water pump and damage to the machine, and don't suddenly close the valve or functional facilities when the pump is running. Examine the steering carefully: if the steering is not correct, change the power cable phase of the distributor, but don't change the internal circuit of the panel.

The startup operation has following two modes:

1. Manual control  universal change switch → manual gear → manual start corresponding pump

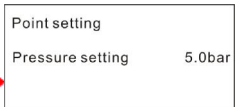
2. Auto control:  universal change switch → auto gear →  set pressure point → start/stop the pump group via the on/off menu.

The pump input current must be at least 10% lower than the current marked on the pump nameplate: too high of the current will quickly cause damage to the

pump. Pump input pressure mustn't be less than 0.5 bar to avoid the damage. As to reduce the current (and reduce flow), gradually close the pump outlet valve and maintain it. After startup, the filter may collect contaminants and impurities. Remove the inner-mesh and replace it when necessary.

Warning: Start the pump under anhydrous condition will cause serious damage to the mechanical seal.

4.4.3 Alarm

4.4.3.1 "Alarm" key to check the alarm

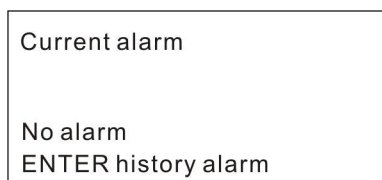

Under any interface, press the "Alarm" key to check real-time alarm, which has three different situations: no alarm is activated, or at least one alarm is activated or at least one alarm has activated and it has been reset automatically.

- 1) If no alarm is activated, the following interfaces will be displayed:
Press the Esc key to return the menu where the previous interface is located.
- 2) If at least one alarm is activated, press the Alarm key, and it will display the latest activated alarm interface. Press the "UP" or "DOWN" key to scroll through other alarms. And then press the Alarm key, it will try to cancel the alarm and return to the main interface. If the alarm hasn't been successfully eliminated, continue the operation cycle.
- 3) At least one alarm has been activated and it has been reset automatically. At this point, press the Alarm key, it will automatically enter the alarm log interface to make it convenient for users to query the history alarm.

4.4.3.2 Alarm reset

Alarm reset can be manual, automatic or semi-automatic:

Manual reset: if the alarm condition no longer exists, press the "ALARM" key to clear the alarm.

Automatic reset: when the alarm condition ends, the alarm is automatically reset.

4.4.3.3 Alarm log

History alarm	006/006
11:37	04/07/2017
AI18	
ACS510 inverter offline	
ENTER current alarm	

On the main menu, it can enter the alarm log interface through the sub menu (alarm record).

Noice:

1. Up to 100 alarms can be recorded. If it exceeds 100 alarms, the new alarm will cover the old alarm so that it can be deleted.
2. Please refer to Appendix 1 for alarm code list.

5. Maintenance

Check the cleanliness of the filter weekly, and remove the dirt.

Check the input current, working pressure and possible leakage monthly.

Annually check the electrical components: contactor situations (replace the contactor when necessary), thermal relay intervention (trip button), and burn marks.

6. Equipment Discarding

The equipment handling must comply fully with the waste disposal regulations of its loca installation site.

When equipment service life terminates, it must be disconnected from the electrical source and dismantled from the worktable. The handling of equipment must comply fully with the waste disposal regulations of its installation country.

Important Note: After removing the equipment from the workbench, attach the notice: "Scrap equipment, please don't use it".

Table 6-1: Alarm Code Parameter Table

Alarm Code	Description	Alarm Action	Reset Mode
AL01	Clock card fault	Shutdown the unit	By manual
AL02	Memory fault	Shutdown the unit	By manual
AL03	B1outlet temp. probe fault	-	Auto
AL04	B2 outlet pressure probe fault	Shutdown the unit	Auto
AL05	B3 return temp. probe fault	-	Auto
AL06	Water flow switch alarm	Stop/machine the unit	Semi-auto
AL07	Pump 1 overload	Stop the pump	By manual
AL08	Pump 2 overload	Stop the pump	By manual
AL09	Pump 3 overload	Stop the pump	By manual
AL10	High pressure alarm	Stop the pump	Auto
AL11	Low pressure alarm	-	Auto
AL12	Inverter fault	Power frequency operation of pump switching	By manual
AL13	Pump 1 Maint. time hint	-	Auto
AL14	Pump 2 Maint. time hint	-	Auto
AL15	Pump 3 Maint. time hint	-	Auto
AL16	Inverter maint. time hint	-	Auto
AL17	Machine unit maint. time hint	-	Auto
AL18	ACS410 inverter offline	Power frequency operation of pump switching	Auto