

# **SG-14 Series**

## **Screenless Granulators**

Date: Mar. 2020

Version: Ver. C (English)





## Contents

<b>1. General Description .....</b>	<b>7</b>
1.1 Coding Principle.....	8
1.2 Feature .....	8
1.3 Technical Specifications .....	10
1.4 Safety Regulations.....	11
1.4.1 Safety Signs and Labels.....	11
1.4.2 Transportation and Storage of the Machine .....	13
1.4.3 Working Environment .....	13
1.4.4 Rejected Parts Disposal .....	14
1.5 Exemption Clause.....	15
<b>2. Structural Features and Working Principle.....</b>	<b>16</b>
2.1 General Description .....	16
2.1.1 Working Principle.....	16
2.2 Safety System.....	17
2.2.1 Emergency Stop Switch .....	17
2.2.2 Safety Switch.....	17
2.3 Electrical Components Description .....	18
<b>3. Installation and Debugging .....</b>	<b>19</b>
3.1 Machine Location.....	19
3.1.1 Installation Place .....	20
3.2 Power Connectors .....	20
3.2.1 Check the Running Direction of the Motor.....	21
<b>4. Operation Guide .....</b>	<b>22</b>
4.1 Startup Pretest.....	22
4.1.1 Before the First Startup .....	22
4.1.2 After Startup for 2 Hours.....	22
4.2 Start and Stop the Granulator .....	22
4.3 Open the Feed Box and Storage Box .....	24
4.3.1 Open the Feed Box .....	24
4.3.2 Open the Storage Box.....	24
4.4 Shut the Feed Box and Storage Box.....	24
4.4.1 Shut the Feed Box.....	24

4.4.2 Shut the Storage Box .....	25
4.5 Motor Reversed Protective Function .....	25
<b>5. Trouble-shooting.....</b>	<b>27</b>
5.1 Granulator Can Not Work .....	27
5.2 Stop Due to Other Reasons.....	27
<b>6. Maintenance and Repair .....</b>	<b>28</b>
6.1 Repair .....	28
6.1.1 Replace the Blades .....	28
6.2 Maintenance .....	31
6.2.1 Daily Check .....	31
6.2.2 Weekly Check .....	31
6.2.3 Monthly Check.....	32
6.2.4 Check and Maintenance of Gear Motor.....	32
6.3 Cleaning.....	33
6.4 Installation of Feed Box, Feed Port and Storage Box .....	34
6.5 Installation of Bearing and Blade Rest.....	35
6.6 Installation of Gear Motor and Coupling.....	37
6.7 Maintenance Schedule .....	38
6.7.1 About the Machine.....	38
6.7.2 Check After Installation.....	38
6.7.3 Daily Check .....	38
6.7.4 Weekly Check .....	38
6.7.5 Monthly Check.....	38
6.7.6 Check Half-yearly or Every 1000 Running Hours .....	39
6.7.7 3 year Checking .....	39

### Table index

Table 1-1: Technical Specifications .....	10
---	----

### Picture index

Picture 1-1: Dimensions.....	10
Picture 2-1: Working Principle.....	16

Picture 2-2: Emergency Stop Switch.....	17
Picture 2-3: Safety Switch.....	17
Picture 2-4: Electrical Components Description.....	18
Picture 3-1: Installation Space .....	19
Picture 3-2: Installation Place .....	20
Picture 4-1: Main Power Switch .....	23
Picture 4-2: START, Emergency Button and STOP Button .....	23
Picture 4-3: Open the Feed Box .....	24
Picture 4-4: Open the Storage Box .....	24
Picture 4-5: Motor Reversed Protective Function .....	25
Picture 6-1: Replace the Blades .....	29
Picture 6-2: Dismantle Fixed Blades.....	29
Picture 6-3: Dismantle Rotate Blades.....	30
Picture 6-4: Star Screw .....	31
Picture 6-5: Cleaning .....	33
Picture 6-6: Installation of Feed Box, Feed Port and Storage Box 1.....	34
Picture 6-7: Installation of Feed Box, Feed Port and Storage Box 2.....	34
Picture 6-8: Installation of Feed Box, Feed Port and Storage Box 3.....	35
Picture 6-9: Installation of Bearing and Blade Rest 1.....	35
Picture 6-10: Installation of Bearing and Blade Rest 2.....	36
Picture 6-11: Installation of Bearing and Blade Rest 1 3.....	36
Picture 6-12: Installation of Gear Motor and Coupling .....	37



# 1. General Description



Please read this manual carefully before using this machine in order to operate correctly against any damage caused due to improper operation.



**Note!**

Always take great care when the knives are within reach, they are very sharp and can cause personal injury.



Forbidden to process flammable or toxic material!

SG-14 series granulators operate in super low speed to cut materials into well-proportioned granules. There are least dusts produced in the cutting process. Multiple security devices ensure high safety grade; automatic reverse running function ensures continuous operation. This series of screenless granulators are suitable for granulating hard and thick materials. For SG-24T series, there are two gear motors and two cutting chambers to work simultaneously. It can granulate the sprues and waste material, also is capable of granulating long and thin or tough sprues.



Model: SG-1417

## 1.1 Coding Principle

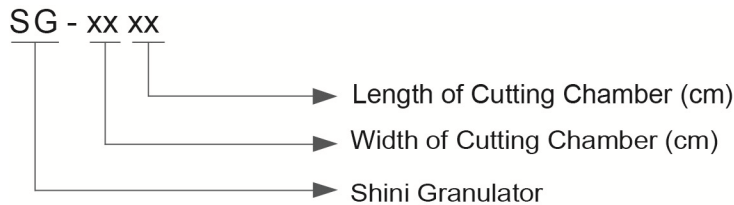

## 1.2 Feature

- 1) SG-14 series renowned gear motor features steady performance, long service life and high torque.
- 2) SG-14 series teeth cutters and cutting blades are integrally fitted in one cutting chamber.
- 3) New-type inclined teeth cutter reduces the possibility of stress concentration, enhance bearing capacity and converts force direction so that cutter lifespan can be prolonged.
- 4) SG-14 series motor shaft and rotor shaft are connected by shaft coupling thus ensuring smooth cutting action and convenient motor replacement.
- 5) When motor blockage occurs, the machine will alarm visibly and enable motor to run reversely. It resumes normal operation automatically after the trouble is clear.
- 6) European type appearance, compact in size and easy to access for cleaning and maintenance.
- 7) Transparent PC feeding hopper.
- 8) Screenless design, well-proportioned size of regrinds and least amount of dusts. Regrinds could be used with virgin materials.



All service work should be carried out by a person with technical training or corresponding professional experience. The manual contains instructions for both handling and servicing. Chapter 6, which contains service instructions intended for service engineers. Other chapters contain instructions for the daily operator.

Any modifications of the machine must be approved by SHINI in order to avoid personal injury and damage to machine. We shall not be liable for any damage caused by unauthorized change of the machine.

Our company provides excellent after-sales service. Should you have any problem during using the machine, please contact the company or the local vendor.

Headquarter and Taipei factory:

Tel: (886) 2 2680 9119

Shini Plastics Technologies (Dongguan), Inc:

Tel: (86) 769 8111 6600

Shini Plastics Technologies India Pvt.Ltd.:

Tel: (91) 250 3021 166

## 1.3 Technical Specifications

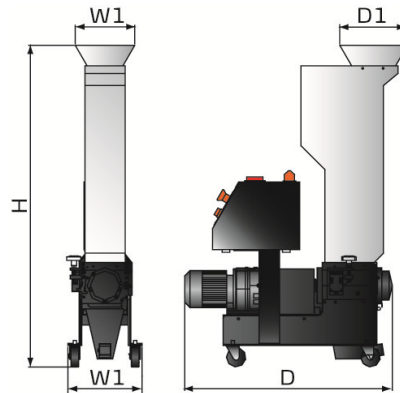

Picture 1-1: Dimensions

Table 1-1: Technical Specifications

Model	SG-1411	SG-1417
Ver.	C	C
Motor Power (kW, 50/60Hz)	0.37 / 0.45	0.37 / 0.45
Rotating Speed (r.p.m, 50/60Hz)	26 / 32	26 / 32
Material of Teeth Cutters	SKD-11	SKD-11
Number of Cutting Blades	1	2
Number of Teeth Cutters	2	3
Cutting Chamber (mm)	140×110	140×175
Max. Throughput Capacity (kg/hr, 50/60Hz)	2	3
Noise Level dB(A)	60~68	60~68
Dimensions		
H (mm)	1080	1080
W (mm)	290	290
W1 (mm)	235	235
D (mm)	740	785
D1 (mm)	210	266
Weight (kg)	83	92

Note: 1) For stainless steel made feed port and manual storage bin, plus "R" at model behind.

2) Max. Capacity of the machine is subject to the size and composition of the material.

3) Noise level will vary with different materials.

4) SKD11 is material code number of Japanese JIS standard.

5) Teeth cutter blades with 3mm width as standard, 4mm as optional (SG - 14 ).

6) For avoiding plastic to adhibit the blade, all materials should be crushed at normal temperature.

7) Power supply: 3Φ, 230 / 400 / 460 / 575VAC, 50 / 60Hz.

## 1.4 Safety Regulations

Follow the instructions in this manual to avoid personal injury and damage to machine components.

The following safety measures shall be followed when operating the granulator.

### 1.4.1 Safety Signs and Labels



Electrical installation must only be done by a competent electrician!



Before the granulator is opened for servicing and maintenance, always disconnect the power with both the main switch and the control switch on the granulator.



Never put any part of your body through the granulator openings, unless both the main switch and the control switch on the granulator are in "OFF" position.



High voltage! danger!

This sign is attached on the control box and the wiring box.



Be careful with the rotating knives, they are very sharp and can cause personal injury!



Be careful with the rotating knives, they are very sharp and can cause personal injury!



The granulator should not be able to start before the feed box and screen frame are properly closed.



Attention please!

Ear protection is used during granulating of plastic materials.









SG-14 Granulators cannot deal with fibre added material.



Attention !

No need for regular inspection because all the electrical parts in the control unit are fixed tightly!

When operate the granulator, please notice the following signs.

	 <p><b>Hazard</b></p> <p>High voltage! May lead to casualty or other serious danger. Please cut off the power before repairing. Circuit diagram should only be changed by professionals. Grounding is necessary.</p>
	 <p><b>Warning</b></p> <p>The cutter are very sharp, can cause injury take out or open protective cover is not allowed when it is running. Keep some distance away from the cutters.</p>
	 <p><b>Notice</b></p> <p>Read the instruction manual carefully before operating. Before start, do the safety device test according to the instruction. It is not allowed to change the design of the machine unless it is approved from the manufacturer.</p>

## 1.4.2 Transportation and Storage of the Machine

### Transportation

- 1) SG-14 series of granulators are packed in plywood cases with wooden pallet at the bottom, suitable for quick positioning by fork lift.
- 2) After unpacked, castors equipped on the machine can be used for ease of movement.
- 3) Do not rotate the machine and avoid collision with other objects during transportation to prevent improper functioning.
- 4) The structure of the machine is well-balanced, although it should also be handled with care when lifting the machine for fear of falling down.
- 5) The machine and its attached parts can be kept at a temperature from  $-25^{\circ}\text{C}$  to  $+55^{\circ}\text{C}$  for long distance transportation and for a short distance, it can be transported with temperature under  $+70^{\circ}\text{C}$ .

### Storage

- 1) SG-14 series should be stored indoors with temperature kept from  $5^{\circ}\text{C}$  to  $40^{\circ}\text{C}$  and humidity below 80%.
- 2) Disconnect all power supply and turn off main switch and control switch.
- 3) Keep the whole machine, especially the electrical components away from water to avoid potential troubles caused by the water.
- 4) Plastic film should be used to protect the machine from dust and rains.

## 1.4.3 Working Environment

The machine should be operated:

- 1) Indoors in a dry environment with max. temperature  $+45^{\circ}\text{C}$  and humidity no more than 80%.

Do not use the machine:

- 1) If it is with a damaged cord.
- 2) On a wet floor or when it is exposed to rain to avoid electric shock.
- 3) If it has been dropped or damaged until it is checked or fixed by a qualified serviceman.
- 4) This equipment works normally in the environment with altitude within 3000m.
- 5) At least a clearance of 1m surrounding the equipment is required during operation. Keep this equipment away from flammable sources at least two meters.

6) Avoid vibration, magnetic disturbance at the operation area.

#### 1.4.4 Rejected Parts Disposal

When the equipment has run out its life time and can not be used any more, unplug the power supply and dispose of it properly according to local code.



In case of fire, Co<sub>2</sub> dry powder fire extinguisher should be applied.



Flammable materials or materials which are contaminated by flammable substances / liquid may not be processed in the granulator. Serious risk of fire or explosion may cause personnel injury.



It is very important to tighten the screw as required torque.



When process item is longer than feed port, please cut long item into half until the length is shorter before processing.



Please don't put materials into the granulator if they are thinner than 2 mm and are soft and flexible, like rubber.

## 1.5 Exemption Clause

The following statements clarify the responsibilities and regulations born by any buyer or user who purchases products and accessories from Shini (including employees and agents).

Shini is exempted from liability for any costs, fees, claims and losses caused by reasons below:

1. Any careless or man-made installations, operation and maintenances upon machines without referring to the Manual prior to machine using.
2. Any incidents beyond human reasonable controls, which include man-made vicious or deliberate damages or abnormal power, and machine faults caused by irresistible natural disasters including fire, flood, storm and earthquake.
3. Any operational actions that are not authorized by Shini upon machine, including adding or replacing accessories, dismantling, delivering or repairing.
4. Employing consumables or oil media that are not appointed by Shini.

## 2. Structural Features and Working Principle

### 2.1 General Description

SG-14 series are belong to "by the press" granulator, which are designed for grinding different types of plastic waste. The granulator are controlled by main power switch, emergency stop button, start button, stop button and safety switches.

#### 2.1.1 Working Principle

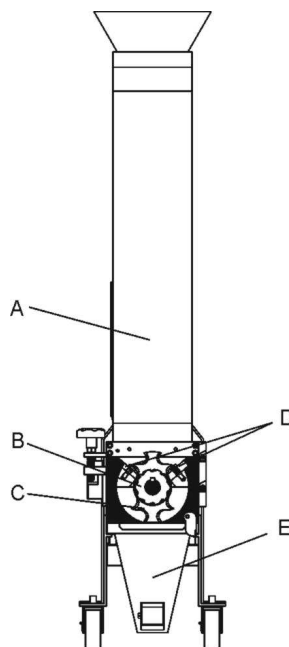

Parts name:

A. Feed box B. Teeth cutter C. Staggered blade D. Fixed blade E. Storage box

Picture 2-1: Working Principle

The material is fed in via a funnel(A) and falls down to the teeth cutters(B), the block material is cutted by the staggered blades(C) and fixed knives(D), then the material is cutted into granule by (B) and (D). The granule directly fall into the storage box(E), it does not need the screen. The cutting chamber is easy to open for cleaning and maintenance. After this, the granulate is ready for re-use in the production machine, or to be transported to a container for later use.



## 2.2 Safety System

To avoid accidental bodily injury during granulator running, a set of safety system has been designed. High-speed rotating cutter is located in the granulator and subject to accident. So safety system has been set up to protect bodily safety. In any cases, the safety system cannot be changed at random. Otherwise the machine will be under dangerous condition and subject to accident happening. The maintenance and preservation of safety system shall be done by professional staff. In case the safety system of granulator is changed, our company will not perform our commitment. The replacement of all spare parts will be done by SHINI Company.

### 2.2.1 Emergency Stop Switch

There is one red button on the control panel. Upon pushing it, the machine will stop running. Turn the button in the arrow direction as shown on the button, the button will reset (counter-clockwise).

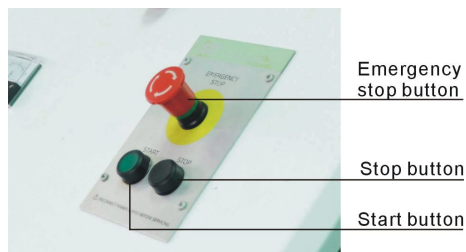

Picture 2-2: Emergency Stop Switch

### 2.2.2 Safety Switch

The granulator equips with safety switch on circuit breaker. If feed box changes the position or circuit breaker trips, it will cut off the power and stop the machine. The granulator has two safety switches, one is between the feed box and cutting chamber, and the other one is between the storage box and machine.

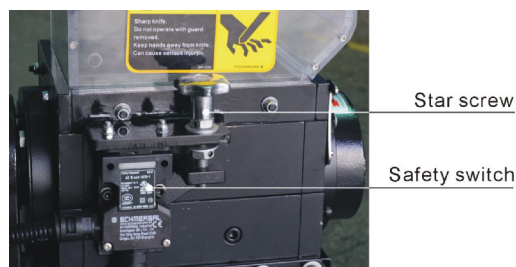

Picture 2-3: Safety Switch

## 2.3 Electrical Components Description

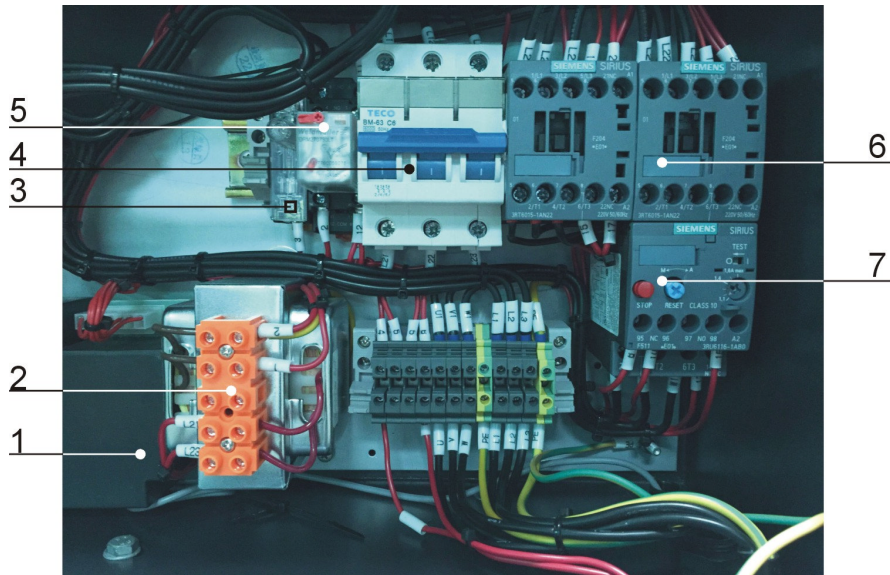

Picture 2-4: Electrical Components Description

1. Reversed PCB.
2. Transformer, provide suitable voltage for control circuit.
3. Fuse, perform the function of overload and short phase protection.
4. Circuit breaker, isolate or short circuit protection.
5. Middle relay, which can connect or disconnect the power from remote.
6. Contactor could connect and disconnect the main circuit from a long distance.
7. Overload relay, can protect the motor or phase short.

### 3. Installation and Debugging



Read through this chapter before installation.



Must abide the following installation steps to avoid personnel injuries or damage of the machine!



Take great care of handing the blades because they are very sharp and may cause cutting injuries!



Power supply of the machine should be handled by qualified electricians!



Notice!

Use protective gloves since the blades are very sharp.

#### 3.1 Machine Location

Make at least 1 meter clearance around the machine to facilitate repair and maintenance.



Picture 3-1: Installation Space

### 3.1.1 Installation Place

Check and make sure the installation ground is level; there is enough intensity when it is running. Lockup the castors.

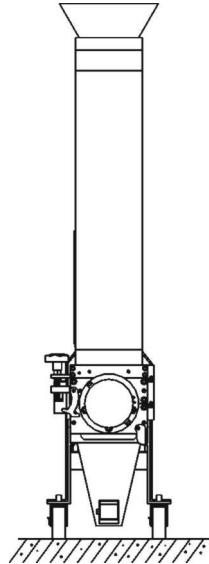

Picture 3-2: Installation Place

## 3.2 Power Connectors

- 1) Make sure voltage and frequency of the power source comply with those indicated on the manufacture's plate, which is attached to the machine.
- 2) Power cable and earth connections should conform with local regulations.
- 3) Use independent power cable and ON / OFF switch. The cable's dia. Should not smaller than those applied in the control box.
- 4) The power cable connection terminals should be tightened securely.
- 5) The machine requires a 3-phase 4-wire power source, connect the power lead (L1, L2, L3) to the live wires, and the earth (PE) to the ground.
- 6) Power supply requirements:
  - Main power voltage:  $\pm 5\%$
  - Main power frequency:  $\pm 2\%$
- 7) Specific power supply specifications please refer to the schematic model.



The power connection of granulator should be completed by the professional electrician.

### 3.2.1 Check the Running Direction of the Motor

- 1) Open the door to check whether the feed box is closed.
- 2) Ensure the main power switch is in ON position.
- 3) Check the emergency stop.
- 4) Start the granulator via pressing the START button and stop the granulator via pressing the STOP button.
- 5) The granulator needs some time to fully come to a halt; after full stop, check whether the running direction is clockwise.



#### Caution!

The cutting tools may be damaged and the granulating capability will be reduced if there is a wrong running direction. Please disconnect the power and transpose any two wires of the three in the main power.

## 4. Operation Guide



Wear gloves during operating to avoid personal injury!



Wear goggles during operating to avoid personal injury!

### 4.1 Startup Pretest

Unpainted part of the machine has been covered with stainless oil. Before use, the stainless oil should be cleaned.

- 1) Clean with a towel.
- 2) Wash with a towel dipping with amyl acetate.

#### 4.1.1 Before the First Startup

- 1) Check whether the granulator is in the level state.
- 2) Check the space of the cutting tools to see whether the lockup screws of the blades are tightened (torque: 280Nm).



Caution!

Adjust the machine to let its four castors share the whole weight and in level state.

#### 4.1.2 After Startup for 2 Hours

- 1) Check the space of the cutting tools of the fixed blades and rotating blades again; check whether the lockup screws of the blades are loose.
- 2) Check the position-adjusting screws of the motor and check whether the position-adjusting screws are tightened.

### 4.2 Start and Stop the Granulator

The granulator is controlled by circuit breaker, safety switch, START/STOP button and emergency stop button.

Main power switch:

It is located at the front control panel. Through rotating the switch to control the startup and stop of the machine.



Picture 4-1: Main Power Switch

START button and STOP button:

These two buttons control the startup and stop of the machine.

Emergency stop:

When an accident happens, this button can do a favor.



Picture 4-2: START, Emergency Button and STOP Button



Caution!

If there are ungrinded crew materials in the feed box or cutting chamber, the granulator shall NOT be stopped, otherwise the crew materials will blockade the rotor and the motor will be overloaded next time you start the machine up.

## 4.3 Open the Feed Box and Storage Box



Before opening the feed box and the storage box, turn off the main power switch and the power switch of the granulator.



Be careful! The blade is very sharp, please take care.

### 4.3.1 Open the Feed Box

- 1) Check if the feed box has been emptied. If so, turn off the main power switch.
- 2) Loosen the long star screw and open the feed box.

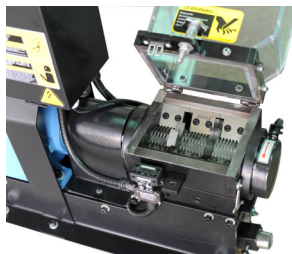

Picture 4-3: Open the Feed Box

### 4.3.2 Open the Storage Box

- 1) Shut off the power of granulator.
- 2) Remove the storage box.

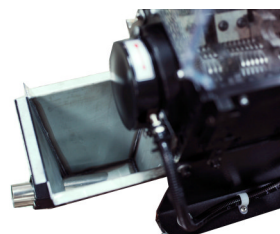

Picture 4-4: Open the Storage Box

## 4.4 Shut the Feed Box and Storage Box

### 4.4.1 Shut the Feed Box

- 1) Check to ensure there is no powder left in the interface or corners.
- 2) Close the feed box forwardly.
- 3) Lock up the star screw and fix the feed box.



#### 4.4.2 Shut the Storage Box



Note!

Before closing, clean the interface surface.

Be careful!

Don't get squeezed and injured.

- 1) Check no powder or leftover material around the storage box; timely remove them if any.
- 2) Push the storage box into along its slide way.

#### 4.5 Motor Reversed Protective Function

When there are hard material appear in the feed box and cutting chamber or for other reason the cutting blades can not cut, this unit will enable blade shaft reverse rotating with alarm, It resumes normal operation automatically after 3 seconds later, so to keep granulating material. The alarm die out after blade shaft rotates normally. If the motor reverse function be started over 3-4 times or more, the motor would be stopped. At this time you can press down the STOP button to cut off the power, and then restart it by press the START button.

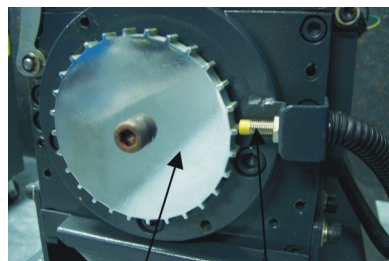

sensor wheel    Sensor

Picture 4-5: Motor Reversed Protective Function

If the rotor has been seized during operation, its working mode is :

Rotor is seized up, auto stop for 1 sec→reverse rotate for 3 secs→stop for 1 sec  
→normal rotate→

A. 1) normal→working

2) seized up→stop for 1 sec→reverse rotate for 3 secs→stop for 1 sec→  
normal rotate

B. 1) normal→working

2) seized up→stop for 1 sec→reverse rotate for 3 secs→stop for 1 sec→  
normal rotate

C. 1) normal→working

2) seized up→machine stops



Mount sensor and ensure its space with wheel sensor to about 2~4mm.

## 5. Trouble-shooting

### 5.1 Granulator Can Not Work

- 1) Check if the emergency stop has been reset. If not, rotate the button anti-clockwise to reset it.
- 2) Check whether the door is closed. If not, the machine could not be started.
- 3) Check if the feeding hopper is completely closed. If not, the machine could not be started. Then, check the lockup clip after opening the door.
- 4) Check the motor's overload protector. The overload protector in the electrical control box will work if the motor overloads. Under that situation, (A) (the green pole) will come out. Press the Reset button B) to reset it. Before startup again, check whether there is any powder in the granulator.
- 5) Check the overload protector of the feeding blower's motor. If the feeding blower does not run, the granulator can not run neither. Check the motor protector in the electrical control box. If it is closed, the switch will be in 0 positions. Reset it to 1 position. (A) (The green pole) will come out. Press the Reset button (B) to reset it.
- 6) Check the space between blades stop will happen or the motor overload protector will trigger off if the blade is very blunt or the space between blades is not correct. More details about checking, replacing and readjusting the blades to see chapter 3.6.

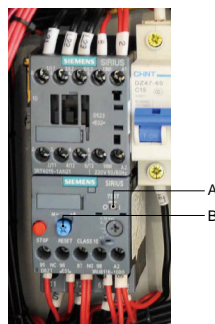

### 5.2 Stop Due to Other Reasons

Connection failure or looseness of safety switch or limit switch can also result in operation failure.



Note! Do not disconnect to safety switch or control switch.

## 6. Maintenance and Repair

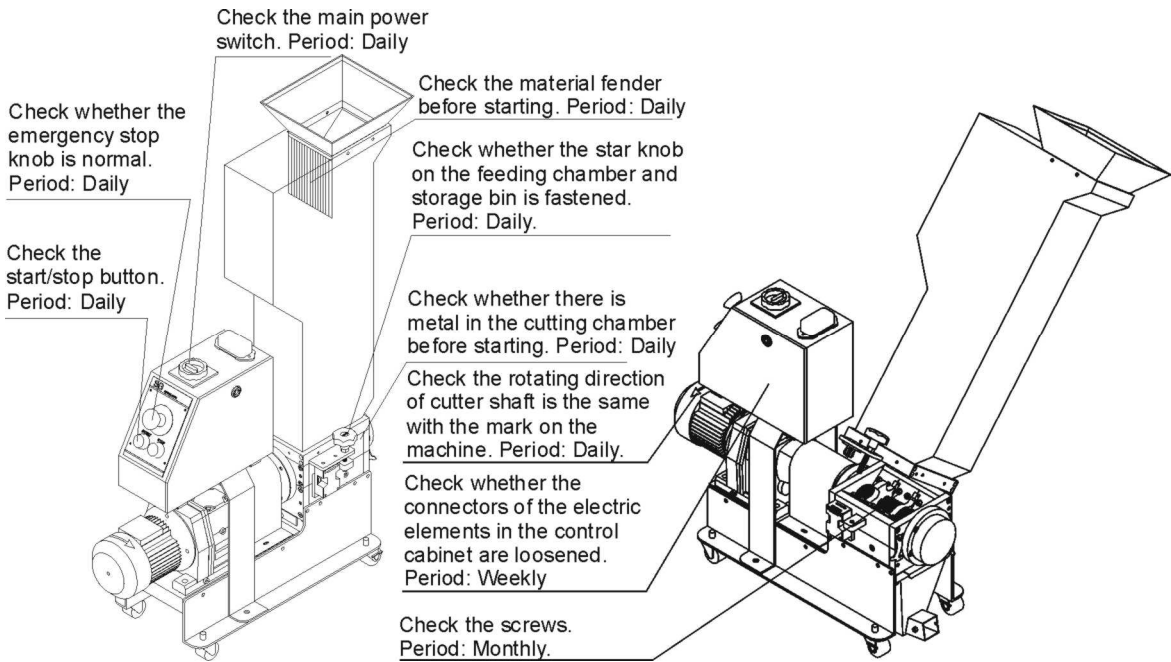

### 6.1 Repair

All the repair must be done by professionals to avoid damage to machine and harm to human body.

#### 6.1.1 Replace the Blades



**Caution!**

Warning: Self-rotation exists due to non-balanced forces or unstable bary center.



Wear gloves to avoid being cut and be careful of the sharp blades!

More details about replacing or maintaining the blades to see chapter 3.5. Inject screw thread fixing glue (light blue LOCTITE 243 recommended) to the fixing screw so to avoid slipping and tighten screws up.



Picture 6-1: Replace the Blades



**Caution!**

To decrease the possibility of harm to other people, the replacement action must be conducted by oneself.



**Attention!**

As to avoid auto-rotation, it should use a thick wood to fasten the rotating blade. Be carefully during the process, the cutter is very sharp!

1) Remove the fixed blades



**Caution!**

To avoid self rotation, block the rotating blade with a thick wood block.

1. Remove the set screws.
2. Remove the fixed blades.
3. Clean the installation surface of the blades.



Picture 6-2: Dismantle Fixed Blades

2) Remove the rotating blades

1. Open the cutting chamber and loosen inner hex screws on bearing block.
2. Take out blade rest.
3. Clean the whole rotating blades and cutting chamber.

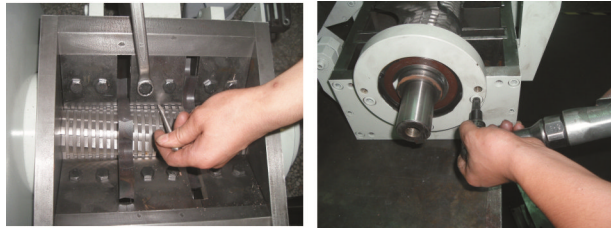

Picture 6-3: Dismantle Rotate Blades



**Caution!**

Press the pressing block and blade when you remove the last screw so to avoid personal injuries.

**3) Install the blades**

Clean carefully the fixed blades and rotating blades and then install them.



Each time to replace the blade, the screw and insulation ring must be replaced also.



**Be careful!**

Cutting blades must be put balanced, prevent it to rotate itself when do the installation. Keep hands from blades to avoid body injuries!



**Attention:**

Don't take other person's help to finish the installation, use a wooden board to block the rotating blade to finish it.

## 6.2 Maintenance

When carrying out maintenance, ensure that there is no material left in the granulator.



Caution!

All stuff concerning repair must be conducted by professionals to avoid damage or harm to human body.

### 6.2.1 Daily Check

- 1) There is rubber shutter in the feed box. If the rubber shutter is damaged, replace it immediately. Otherwise the fragment of the shutter will damage the blades in the cutting chamber.
- 2) Check whether the Emergency Stop works properly. Start the machine and then stop it via Emergency Stop. Rotate the button an ti-clockwise to reset the Emergency Stop.
- 3) Check the main power switch, start/stop button.
- 4) Check the reversed rotating function.
- 5) Check star screw, safety screw is part of granulator' safety system, its length is pre-designed, when the screw is loosen, the granulator will stop working so to protect the machine. The thread length of the safety screw is 60mm, damaged screw needs to be replaced by a new one.

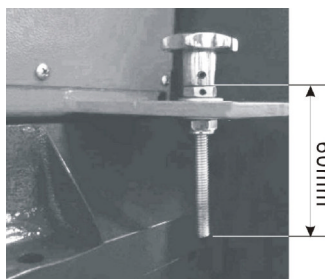

Picture 6-4: Star Screw

### 6.2.2 Weekly Check

- 1) Check the power wire to see whether there is any damage. If so, replace it immediately.
- 2) Check the safety switch.

### 6.2.3 Monthly Check

Check the gear motor's working condition.

### 6.2.4 Check and Maintenance of Gear Motor

Check lubricating oil for every six months or after 3000 hours in operation

#### 1) Check oil level:

1. Cut power off so to avoid electric shock and wait till the gear motor get cooled.
2. Remove oil level plug to check if the oil has been filled up full.
3. Install oil level plug.

#### 2) Check the lubricating oil:

1. Cut power off so to avoid electric shock and wait till the gear motor get cooled.
2. Open the oil drainage plug to get oil sample.
3. Check viscosity index of the lubricating oil.  
If it is evidently turbid, please replace it as soon as possible.
4. Check the lubricating oil level and install oil level plug.

#### 3) Lubricating oil replacement:

Increased viscosity of the lubricating oil will make it harder to discharge the oil, so better replace it when the gear motor is in its operational temp.

1. Cut off the power supply to avoid electric shock!
2. Lay an oil pan under the oil drainage plug.
3. Open the oil level plug, air valve and oil drainage plug.
4. Drain all the lubricating oil out.
5. Install oil drainage plug.
6. Fill in new lubricating oil in same brand.
7. Tight up the oil level plug and air valve.

#### 4) Brand of lubricating oils (ambient temperature : -10°C~40°C):

Mobil:	Mobilgear 630
Shell:	Shell Omala 220
Aral:	Aral Degol BG 220
BP:	BP Energol GR-XP 220
Texaco:	Meropa 220



## 6.3 Cleaning



Caution: The blade may do harm to human body when opening the feed box!

- 1) Check whether the feed box is emptied before stopping the machine.
- 2) Clean the exterior surface of the feed box.
- 3) Turn off the main power switch.
- 4) Clean the shutter of the feed box with a dust separator.
- 5) Clean both surfaces of the cutting chamber; open the upper cutting chamber and to clean the remain material by using revolving rod to turn the blade shaft.
- 6) Screw off the star knob to open the feed box backwardly.
- 7) Clean the interior surface of the feed box.
- 8) Move away the baffle plate of storage box.
- 9) Uninstall the storage box and clean it.

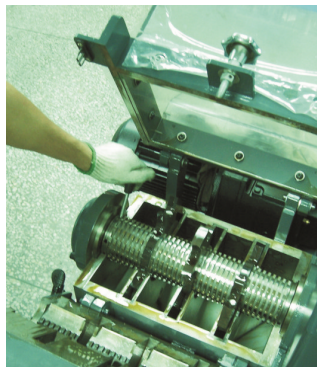

Picture 6-5: Cleaning



Do step 5 for every time of machine cleaning and also it at least has to be done for one time after 300 hours in operation.

## 6.4 Installation of Feed Box, Feed Port and Storage Box

- 1) Lift up the feed box 1 to fix it onto the cutting chamber with screws (M8×35).

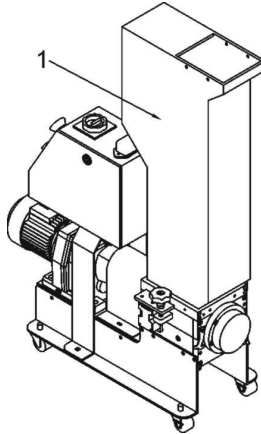

Picture 6-6: Installation of Feed Box, Feed Port and Storage Box 1

- 2) Hold the feed port 2, and insert it into the feed box.

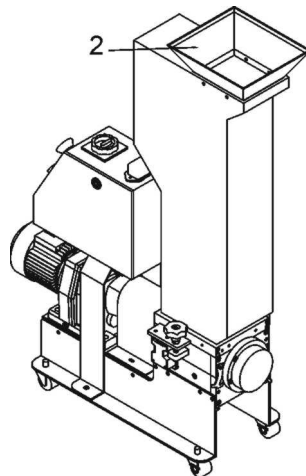

Picture 6-7: Installation of Feed Box, Feed Port and Storage Box 2

- 3) Before fixing the feed port, place the plastic strips at the top of feed box and let feed port press against it.
- 4) Lay down the feed port and align its screw holes with the screw holes on the feed box, then lock the screws up (M8×20).

- 5) Hold the storage box with both hands and push it into its right position along the slide way.

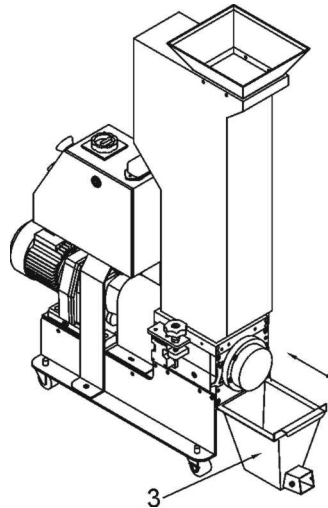

Picture 6-8: Installation of Feed Box, Feed Port and Storage Box 3



Caution!

When mount the storage box, push along the slideway to the end or its safety switch could not be fully closed.

## 6.5 Installation of Bearing and Blade Rest

- 1) Install the bearing 2. bearing washer 1. bearing sleeve 7 into the bearing base 3.
- 2) Insert the blade shaft 4 into the bearing sleeve vertically 7. Then sleeve the staggered blade 5 and the teeth blade 6 on the bearing spacing.

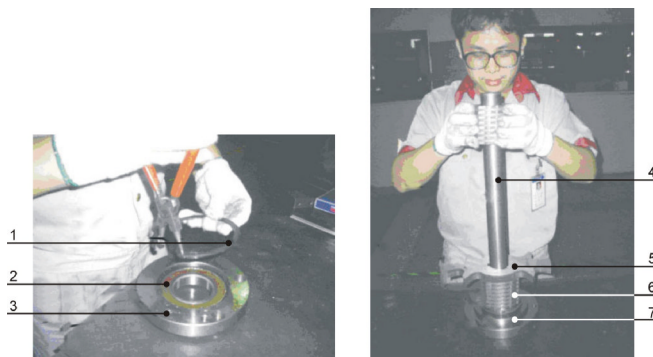

Picture 6-9: Installation of Bearing and Blade Rest 1

3) Put the blade rest 2 into the cutting chamber 1, Let both terminal of the bearing tallies with the grooves.

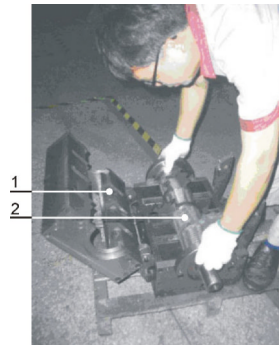

Picture 6-10: Installation of Bearing and Blade Rest 2

4) Fix the bearing base on the cutting chamber.



Picture 6-11: Installation of Bearing and Blade Rest 1 3



Notice!

Daub the lubrication on the bearing and bearing base. Use proper twisting force to lock the screw tightly.

Table 6-1: Attached form: cutters and other fixing screw torque

Thread size	M10	M12	M14	M16	M18	M20	M22	M24
Axial force(N)	23.8	34.5	47	65.5	78.5	103	129	149
Fixing torque (Nm)	50	86	135	215	290	420	570	730

## 6.6 Installation of Gear Motor and Coupling

- 1) After complete the mounting of blade rest and cutting chamber to the base. Align blade shaft to the grooves on coupling to mount the key and also mount coupling on the blade shaft,
- 2) Put the gear motor on its fixing plate and its connecting key lies in the main shaft groove. Insert main shaft after align itself with coupling. Screw up with four screws (M12x40).

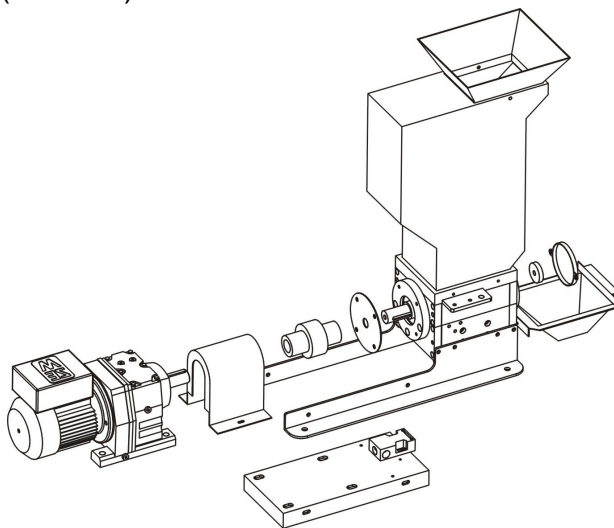

Picture 6-12: Installation of Gear Motor and Coupling



### Caution!

To avoid cutters from self-rotating, use a thick wooden block to lock the cutters when install or uninstall the gear motor.



### Be careful!

The cutting blade rest shall be put stably. Self turning of cutting tool shall be prevented prior to installation. At the time of operating, hand shall stay away from the cutting tool to avoid bodily injury.

## 6.7 Maintenance Schedule

### 6.7.1 About the Machine

Model \_\_\_\_\_ SN \_\_\_\_\_ Manufacture date \_\_\_\_\_

Voltage \_\_\_\_\_  $\Phi$  \_\_\_\_\_ V Frequency \_\_\_\_\_ Hz Power \_\_\_\_\_ kW

### 6.7.2 Check After Installation

- Check if pipe connections are firmly locked by clips.
- Check the gap between fixed blade and rotating blade.
- Check the rotating balance of the belt wheel.

#### Electrical Installation

- Voltage: \_\_\_\_\_ V \_\_\_\_\_ Hz
- Specs of the fuse: 1 Phase \_\_\_\_\_ A 3 Phase \_\_\_\_\_ A
- Check phase sequence of the power supply.
- Check the rotating direction of the conveying blower.

### 6.7.3 Daily Check

- Check main power switch.
- Check emergency stop button.
- Check start / stop button.
- Check material check plate (strip) is perfect or not.
- Check whether emergency stop and safety switch works normally.
- Clean feed box.
- Check whether start, stop and power switches are normal.

### 6.7.4 Weekly Check

- Check all the electrical cables.
- Check if there are loose connections of electrical components.
- Check blade condition.
- Check whether set screws in fixed and rotate blades are under looseness.
- Check if there is abnormal noise, vibration and heat in reduction gear.
- Check the cracking window

### 6.7.5 Monthly Check

- Check the status of the belt.

- Check the overload protection function of the motor.
- Check motor reversed running function.
- Check the tightness of the blades.

#### 6.7.6 Check Half-yearly or Every 1000 Running Hours

- Check or replace lubrication for gear motor.
- Check lubrication of bearing.
- Check coupling.
- Evaluation of machine condition.

#### 6.7.7 3 year Checking

- PC board renewal.
- No fuse breaker renewal.