

Ver. A	Title		Drawing No.		Scale	Page
	SGF-2628E		SGF-2628E-GB-400V-A-1		Standard	1
	Main Circuit Diagram				GB	Totally 4
	Version		A		Pages	4
	Designer		Approved by		Voltage	400V
	Proofread by		Date		Frequency	50Hz
	Checked by		20150203			
Mark	Before modification	Modified by	Modify date			
	After modification					

SHINI 信易電熱機械股份有限公司
Shini Plastics Technologies, Inc.

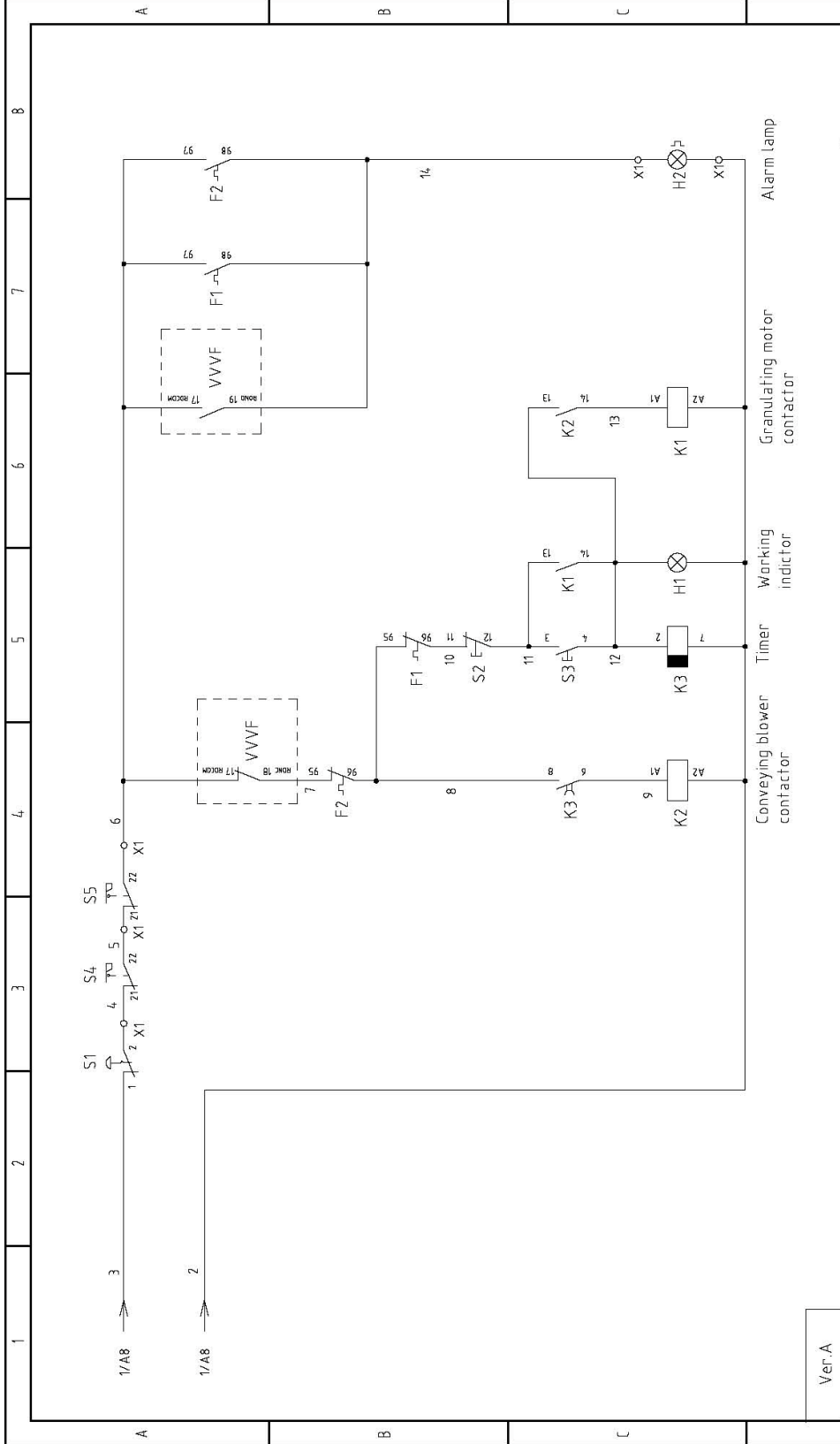

Ver.A																	
Mark	Before modification	After modification	Modified by	Modify date	Checked by	Date	20150203										
Designer	Proofread by	Approved by	Version	A	Title		SGF-2628E		Drawing NO.		SGF-2628E-GB-400V-A-2		Page	2			
													Standard	GB	Totally	4	Pages
													Voltage	400V	Frequency	50HZ	
													SHINI		信易電熱機械股份有限公司 Shini Plastics Technologies, Inc.		

1 2 3 4 5 6 7 8

A

B

C

D

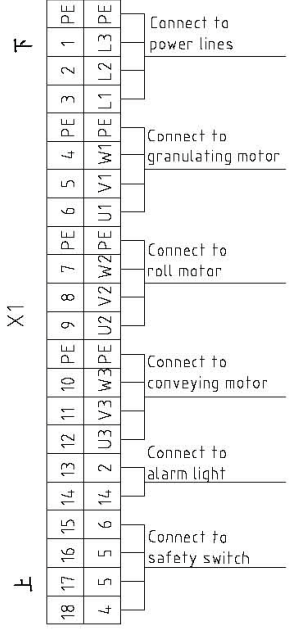
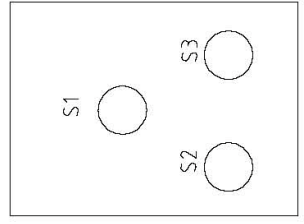
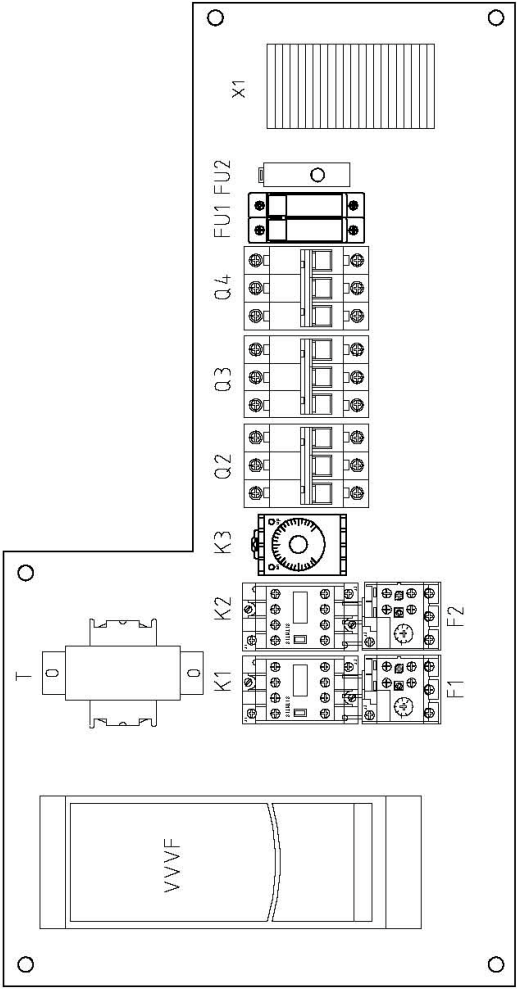

Ver. A

Mark	Before modification	After modification	Modified by	Modify date	Checked by	Proofread by	Designer	Drawer	Version	A	Title	SGF-2628E		Scale	Page
				20150203							Electrical Components Layout	SGF-2628E-GB-400V-A-3		Standard	3
											信易電熱機械股份有限公司 Shini Plastics Technologies, Inc.		GB	Totally	
														4	Pages
															400V
															50HZ

1 2 3 4 5 6 7 8

1		2		3		4		5		6		7		8	
NO.	Symbol	Name	Manufacturer	Type	Specification	Number	Material number	Remark							
1	Q1	Main power switch	MOELLER	TO-2-1/EA/SVB	16A	1	YE10021160000								
2	Q2	Circuit-breaker	TECO	BM-63C/3020S	20A	1	YE40302003000								
3	Q3,Q4	Circuit-breaker	TECO	BM-63C/3006S	6A	2	YE40300603000								
4	K1	Contact	SIEMENS	3RT6017-1AN21	220VAC 50/60Hz	1	YE00601721000								
5		Auxiliary contact	SIEMENS	3RH6911-1AA10	1NO	1	YE00691110000								
6	K2	Contact	SIEMENS	3RT6015-1AN21	220VAC 50/60Hz	1	YE00601521000								
7	K3	Timer relay	YUYUN	TRF-N 3M	220VAC 50/60Hz	1	YE86222000000								
8	F1	Overload relay	SIEMENS	3RU6116-1KB0	9-12.5A	1	YE01169125000								
9	F2	Overload relay	SIEMENS	3RU6116-1BB0	1.4-2A	1	YE01160140000								
10	FU1	Fuse**	CHINT	RT18-32	2P	1	YE41032200000								
11		Fuse core	CHINT	10x38 500V 1A	2A	2	YE46002000100								
12	FU2	Fuse**	YINDA	FS-10	2A	1	YE41001000000								
13	VVVF	Frequency converter	ABB	ACS350-03E-02A4-4	400V 0.75KW	1	YE75350300000								
14	T	Transformer**	BAIYUN	BY-0407	IN=400V OUT=230V 300mA	1	YE70402300700								
15	X1	Terminal board	PHOENIX	2.5mm ²	32A	18	YE61250040000								
16		Terminal board	PHOENIX	2.5mm ² PE	32A	4	YE61253500000								
17	S1	Emergency stop button	SCHNEIDER	XB2BS542C	400VAC	1	YE11254200000								
18	S2	Stop button	SCHNEIDER	XB2BAZ2C	400VAC	1	YE11222000000								
19	S3,H1	Start button(With lamp)	SCHNEIDER	XB2BW33M1C	400VAC	1	YE11223100000								
20	S4,S5	Safety switch	SCHMERSRC	AZ152VK-14.76	AC-15	2	YE16147600100	(1)							
21	H2	Indicate lamp	SHINI	LED-3051	220VAC	1	YE83305100200	(1)							
22	M1	Motor	---	---	400V 50/60Hz 4.0KW	1	-----	(1)							
23	M2	Motor	---	---	400V 50/60Hz 0.4KW	1	-----	(1)							
24	M3	Motor	---	---	400V 50/60Hz 0.55KW	1	-----	(1)							
Ver. A Notes: (1)Means it's not the material inside the control box. / *means possible broken parts. **means easy broken part. and spare backup is suggested.															
D		Title		Drawing NO.		Scale		Page		4		4		8	
		SGF-2628E		SGF-2628E		GB		Verage		4.00V		4		50HZ	
		Electrical Components List		SGF-2628E-GB-400V-A-4		Standard		Frequency		4		4		50HZ	
Mark		Before modification		After modification		Modify date		Checked by		Date		20150203			
		Designer		Version		A		Approved by		Date		20150203			
		Drawn		Version		A		Checked by		Date		20150203			
		Prefread by		Version		A		Checked by		Date		20150203			
		Modified by		Version		A		Checked by		Date		20150203			



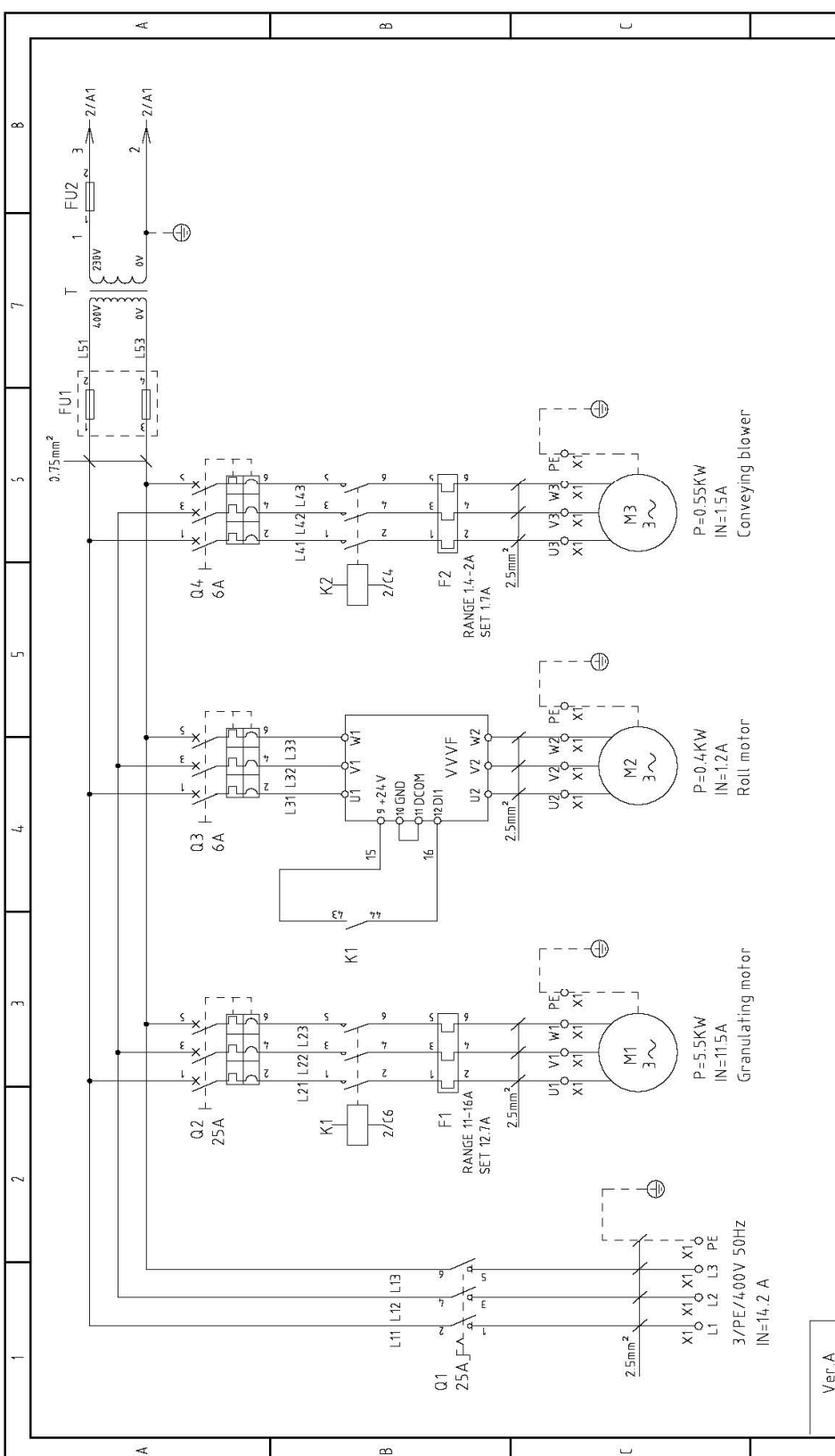

Ver. A	Title		Drawing No.		Scale	Page
	SGF-2642E		SGF-2642E		GB	1
	Main Circuit Diagram		SGF-2642E-GB-4.00V-A-1		Standard	Totally 4
	A		Version		Pages	4
	Designer		Approved by		Voltage	400V
	Proofread by		Date		Frequency	50HZ
	Checked by		20150203			
Mark	Before modification	Modified by	Modify date	After modification		

SHINI
信易電熱機械股份有限公司
Shini Plastics Technologies, Inc.

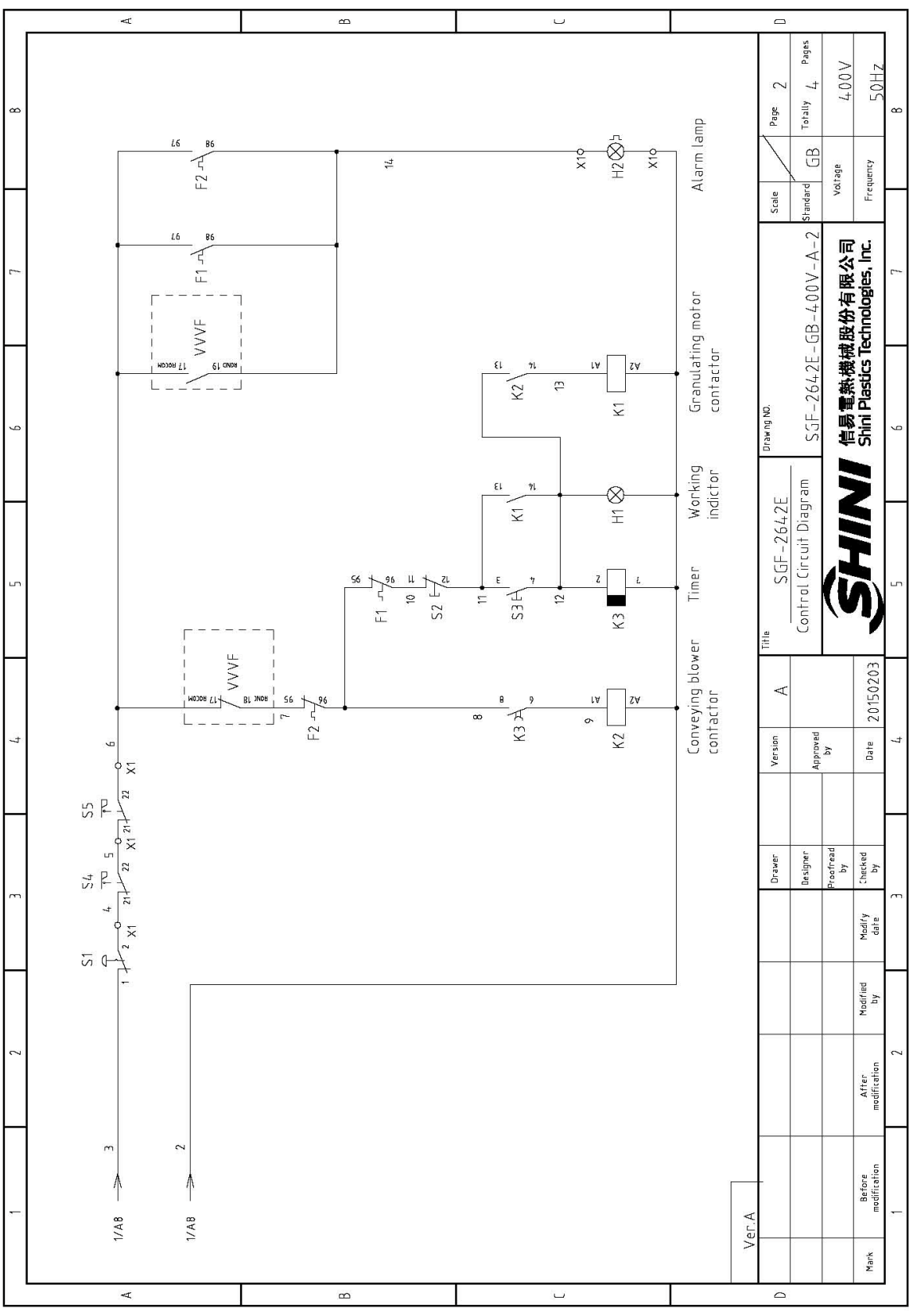

Ver.A

Mark	Before modification	Modified by	Modify date	Checked by	Date	20150203	Version	A	Title	Drawing NO.		Scale	Page	
	After modification	Approved by	Pages							Standard	2			
Control Circuit Diagram										SGF-2642E-GB-400V-A-2		GB	Totally	4
SHINI										信易電熱機械股份有限公司 Shini Plastics Technologies, Inc.		Voltage	400V	
												Frequency	50HZ	
												8		

1 2 3 4 5 6 7 8

A

B

C

D

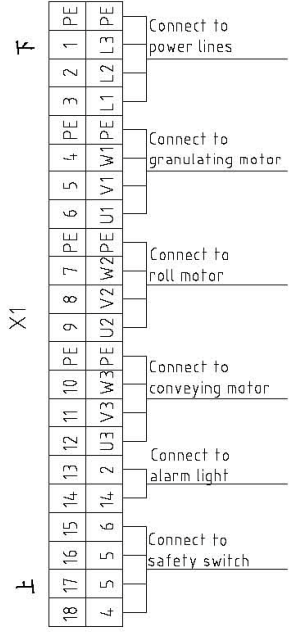
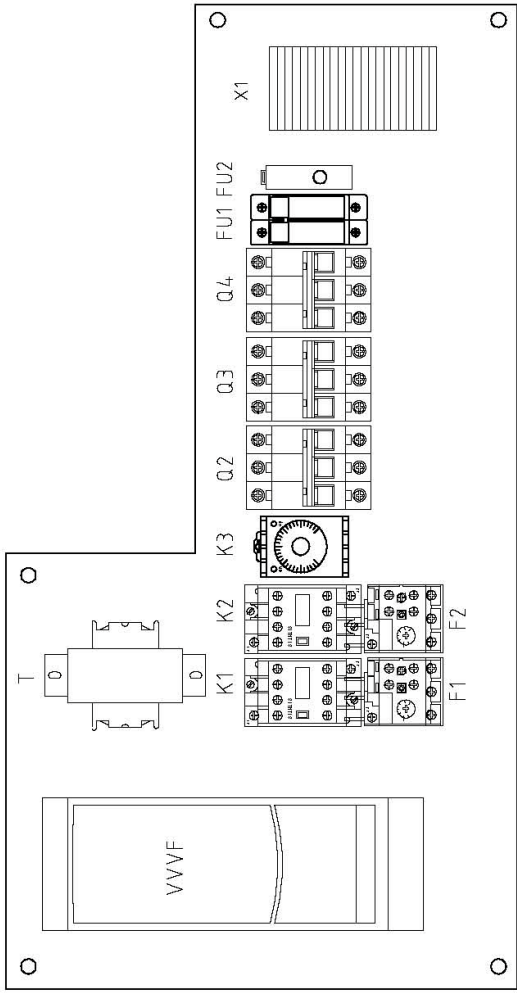

Ver.A

Mark	Before modification	After modification	Modified by	Modify date	Designer	Version	A	Title	SGF-2642E	Drawing No.	SGF-2642E-GB-4.00V-A-3	Scale	GB	Page	3
				20150203	Approved by			Electrical Components Layout						Totally	4
					Checked by			SHINI 信易電熱機械股份有限公司 Shini Plastics Technologies, Inc.						Voltage	4.00V
														Frequency	50HZ

1

2

3

4

5

6

7

8

1		2		3		4		5		6		7		8	
NO.	Symbol	Name	Manufacturer	Type	Specification	Number	Material number	Remark							
1	Q1	Main power switch	MOELLER	PI-25/EA/SV8	25A	1	YE1012520000								
2	Q2	Circuit-breaker	TECO	BM-63C/3025S	25A	1	YE40302503000								
3	Q3,Q4	Circuit-breaker	TECO	BM-63C/3006S	6A	2	YE40300603000								
4	K1	Contactor	SIEMENS	3RT6025-1AN20	220VAC 50/60Hz	1	YE00602522000								
5	K2	Auxiliary contactor	SIEMENS	3RH6911-1AA10	1ND	1	YE00691100000								
6	K3	Contactor	SIEMENS	3RT6015-1AN21	220VAC 50/60Hz	1	YE00601521000								
7	K3	Timer relay	YUYUN	TRF-N 3M	220VAC 50/60Hz	1	YE86322000000								
8	F1	Overload relay	SIEMENS	3RU6126-4AB0	11-16A	1	YE01260110000								
9	F2	Overload relay	SIEMENS	3RU6116-1BB0	1.4-2A	1	YE01160140000								
10	FU1	Fuse**	CHNT	RT18-32	2P	1	YE41032200000								
11		Fuse core	CHNT	10x38 500V 1A	2A	2	YE46002000100								
12	FU2	Fuse**	YINDA	FS-10	2A	1	YE41001000000								
13	VVVVF	Frequency converter	ABB	ACS350-03E-02A4-4	400V 0.75KW	1	YE75350300000								
14	T	Transformer**	BAIYUN	BY-04.07	IN=400V OUT=230V 300mA	1	YE70402300700								
15	X1	Terminal board	PHOENIX	2.5mm ²	32A	18	YE61250040000								
16		Terminal board	PHOENIX	2.5mm ² PE	32A	4	YE61253500000								
17	S1	Emergency stop button	SCHNEIDER	XB2BS542C	400VAC	1	YE11254200000								
18	S2	Stop button	SCHNEIDER	XB2BA22C	400VAC	1	YE11222000000								
19	S3,H1	Start button(With lamp)	SCHNEIDER	XB2BW33M1C	400VAC	1	YE11223100000	(1)							
20	S4,S5	Safety switch	SCHMERSRC	AZ152VK-14.76	AC-15	2	YE16147600100	(1)							
21	H2	Indicate lamp	SHINI	LED-3051	220VAC	1	YE83305100200	(1)							
22	M1	Motor	---	---	400V 50/60Hz 5.5KW	1	----	(1)							
23	M2	Motor	---	---	400V 50/60Hz 0.4KW	1	----	(1)							
24	M3	Motor	---	---	400V 50/60Hz 0.55KW	1	----	(1)							
Ver.A Notes: (1)Means it's not the material inside the control box. / *means possible broken parts.**means easy broken part. and spare backup is suggested.															
Ver.A		Notes: (1)Means it's not the material inside the control box. / *means possible broken parts.**means easy broken part. and spare backup is suggested.		Title		SGF-264ZE		Drawing No.		Scale		Page		4	
D				Designer		Approved by		Electrical Components List		Standard		GB		Totally 4	
Mark		Before modification		After modification		Modify date		20150203		Voltage		400V		Frequency	
								SGF-264ZE-GB-4.00V-A-4		Frequency		50Hz		8	

