



## "Budget" Series Shini Volumetric Doser

SCM-EB



Refer carefully to this manual before operation.

# SCM-EB Series

## ■ Coding Principle

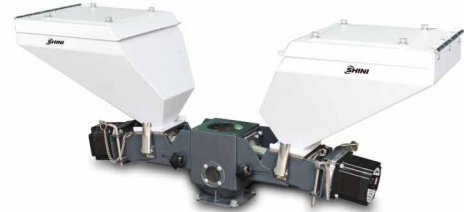
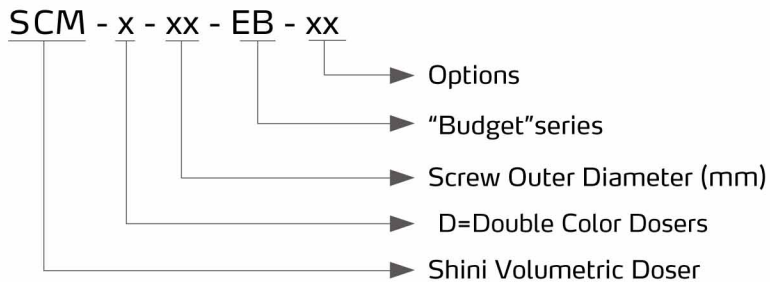

SCM-D-EB

## ■ Features

- Dosing screws are chrome plated for durability.
- Use step motor and free from maintenance.
- Unit is comprised of standard modules for easy of cleaning, disassembly and interchangeability.
- It also can meet the requirement of external signal input.
- The current mode can be recorded without interrupted by power failure.
- Compulsory material cleaning makes it easier to replace masterbatch.
- Applicable to injection and extrusion molding.
- 50 recipes are available for permanent recording of material discharging time and finished products weight (for extruder, it is max. throughput per minute).
- Micro-metering mode is available, and mode cycle can be set to add additives periodically.
- Equipped with the RS485 communication port.

## ■ Application

SCM-EB series volumetric dosers are suitable for injection molding, extrusion blow molding and other occasions, and can be used for auto-proportional mixing of virgin materials, regrinds, master batch or additives. The injection molding machine supports various external signal input modes. When working with the extruder, SCM-EB can adjust the feeding speed automatically with the extruder's processing speed to ensure stable color difference of the product. Besides, double-color doser is available for collocating with multiple color dosers if required. Due to small additives proportion and dosage, SCM-EB can work with the Venturi Loader VL to realize auto feeding of the master batch.

## ■ Working Principle

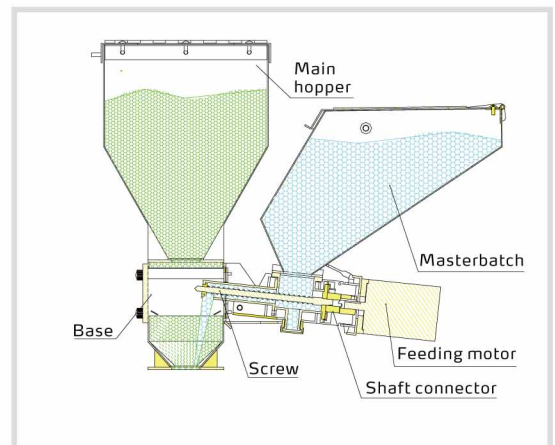

## Outline Drawings

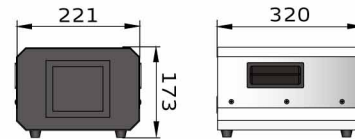
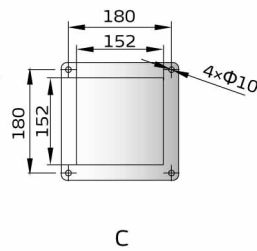
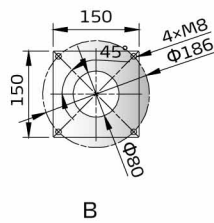
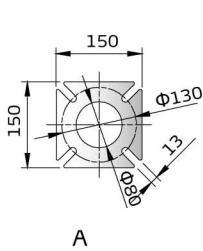
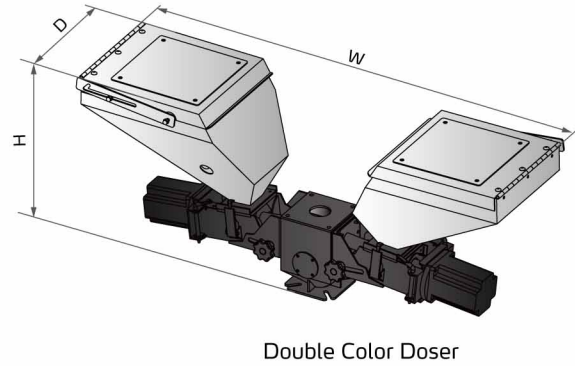
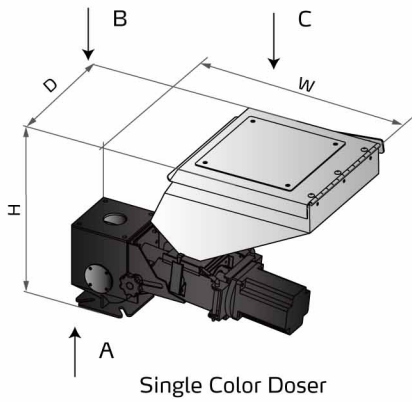

Control Box

## Specifications

Model	Single Color Doser				Double-color Doser
	SCM-12-EB	SCM-16-EB	SCM-20-EB	SCM-30-EB	SCM-D-EB
Motor Power (kW, 50/60Hz)	0.06	0.06	0.06	0.06	0.06 × 2
Output Power of Mixer (kW, 50/60Hz)	0.25	0.25	0.25	0.25	0.25
Screw External Dia. (mm)	12	16	20	30	**
Output Capacity (kg/hr)	0.1-10	0.5-30	3-60	8-110	*
Storage Hopper(L)	10	10	10	10	10
Dimensions	H(mm)	420	420	420	420
	W(mm)	585	585	585	1030
	D(mm)	300	300	300	300
Weight	18	18	18	18	30

- Notes: 1) "\*" stands for the output capacity depends on model selected, data of the single color doser can be a reference. For example: SCM-D-12 / 16, output capacity 0.6-40kg/hr(1.3-88lb/hr).  
 2) "\*\*" stands for external dia. of screw is up to model selected.  
 3) The output capacity is obtained by continuous testing under the conditions of masterbatch in material bulk density of 1.2 kg/L, and diameter of 2-3 mm.  
 4) Power supply: 1Φ, 115/230V, 50/60Hz.

## Options

Low level sensor can be opted to give an alarm when masterbatch is insufficient, and add "LS" at the end of the model code.

# SCM-EB Series

## Accessory

- Mixer CMB-1 to enhance the mixing uniformity



Collocated with the mixer

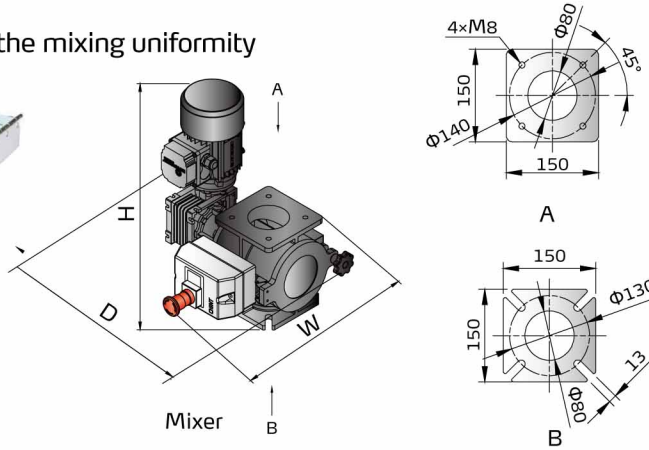

Model	CMB-1
Power(kW)	0.25
H(mm)	364
W(mm)	347
D(mm)	371

Power: 3 $\Phi$ , 400VAC, 50Hz

- Main material hopper makes it easy for the customer to add materials

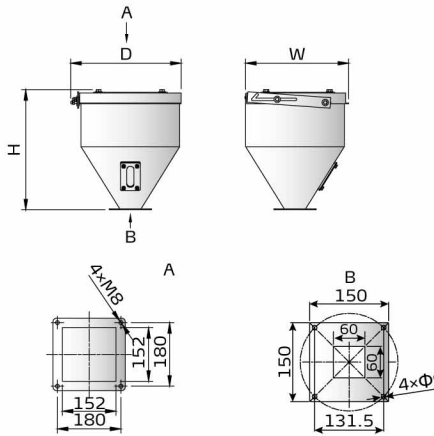

Model	MH-15
Capacity(L)	15
Material	SUS201
H(mm)	364
W(mm)	347
D(mm)	371

- Heavy-duty base (used when collocating with the SEHD/SHD-E/SHD-EB-75~300 or SHD-160U~SHD-450U)

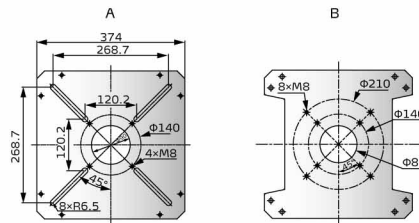
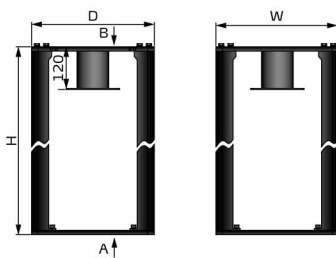

Heavy-duty base dim.

Model	HB-1	HB-2
H(mm)	332	527
D(mm)	374	374
W(mm)	374	374

Note: The model is HB-1 when collocating with standard SCM;

The model is HB-2 when collocating with standard SCM+CMB-1;

- The long hopper is used with the heavy-duty base

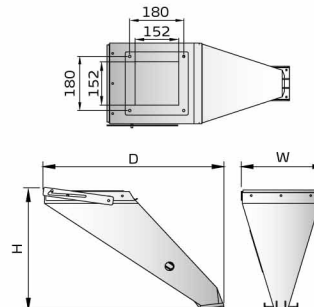

Long hopper dia.

Model	LH-15
Capacity(L)	15
Material	SUS201
H(mm)	411
D(mm)	608
W(mm)	281

## Shini Group

Addr: No. 23, Minhe St., Shulin Dist.,  
New Taipei, Taiwan

Tel: +886 2 2680 9119

Fax: +886 2 2680 9229

Email: [shini@shini.com](mailto:shini@shini.com)

### Factories:

- Taiwan
- Dongguan
- Pinghu
- Ningbo
- Chongqing
- Pune