



## "Standard" Series SG-23/30/36E

SG-3675E



Refer carefully to this manual before operation.

## ■ Coding Principle

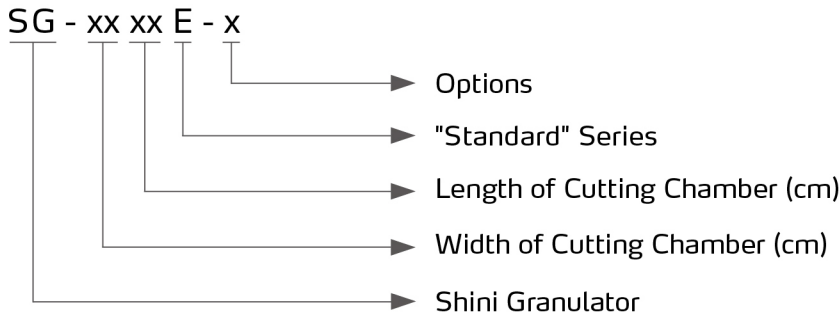

SG-2336E

## ■ Features

- SG-23E series adopts staggered blades, SG-30E and SG-36E series adopts paddle blades.
- Blades adopt imported steel to ensure high quality and high durability.
- Staggered blades design can decentralize working load when granulating to increase cutting efficiency and quick blades changing without readjustment.
- Paddle blades with increased blade inclination design to ensure better cutting effect and lower noise.
- Equipped with motor overload relay and multiple safety devices.
- Easy access to convenient maintenance and cleaning.
- Compact in size for saving floor space and castors for easy movement.
- Equipped with presetting knife jig, rotating blades can be adjusted in the fixture outside the machine inside of machine instead of machine inside. It made blades adjustment much easier.

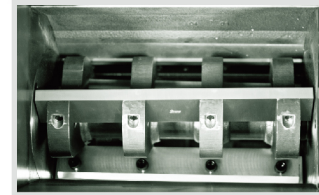

Paddle Cutter

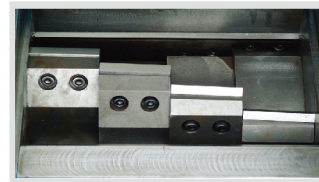

Staggered Cutter

## ■ Application

SG-23E/30E/36E series of "standard" central granulators are built to conform to sound-proof models both in safety configuration and operation security. They are suitable for centralized recycling of wastes and rejected products from injection, blow molding and extrusion lines. The granulators feature optimal structure, easy operation and quick blades changing. Staggered rotating blades can easily grab and cut the materials and ensures low energy consumption.

## ■ Options

### Full-receiver Alarm Device

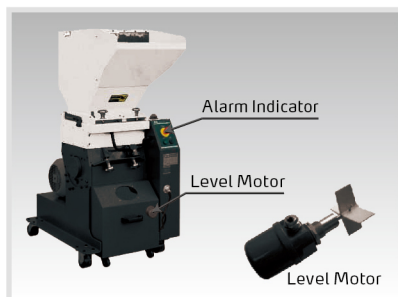

Full-receive alarm device can help to realize unmanned operation and no materials will be wasted. Whenever the regrind level reaches the motor position, the machine will be forced to stop and be cut off via it is sensor, thus stop the granulator and warn the user by sounding an alarm. Add "FAD" at the end of the model code.

### Special Screen

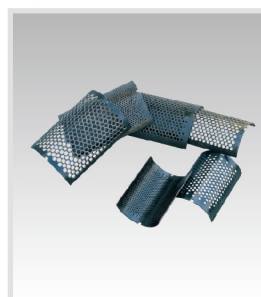

Optional screen mesh sizes includes  $\Phi 4, \Phi 6, \Phi 10, \Phi 12$  (mm) which are applicable to SG-23E/30E series and  $\Phi 8, \Phi 12, \Phi 17, \Phi 25$  (mm) which applicable to SG-36E series. All can be selected as per customer's requirement. Add "SS + screen diameter" at the end of the model code, e.g.:  $\Phi 8\text{mm}$  , add "SS08".

# SG-23E/30E/36E Series

## Flywheel

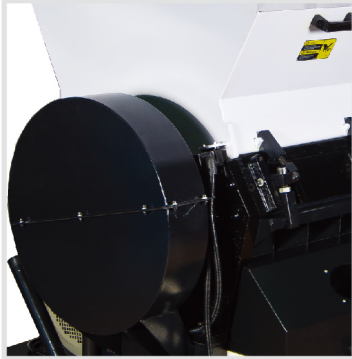

Increase inertia, thereby increasing the cutting ability. At the same time can result in a more balanced force and longer service life. It is an option for SG-36E series. Add "FW" at the end of the model code.

## Feed Hopper with Magnet

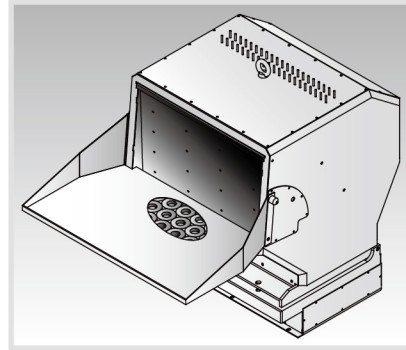

Feed hopper with magnet is used to take out metal craps and impurities in the material. Add "FHM" at the end of the model code.

## Outline Drawings

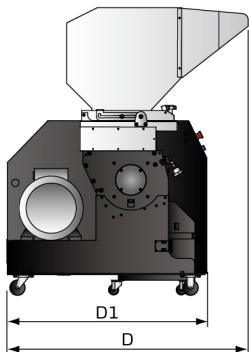
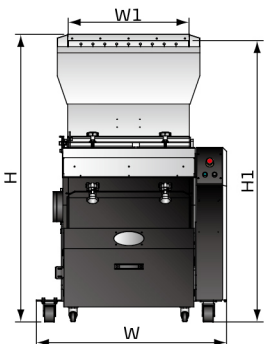

## Specifications

Model	SG-2324E	SG-2336E	SG-2348E	SG-3048E	SG-3060E	SG-3650E	SG-3675E		
Motor Power (kW, 50/60Hz)	5.5/6.3	7.5/8.6	11/12.6	11/12.6	15/17.3	18.5/21	30/34.6		
Rotating Speed (rpm, 50/60Hz)	415/500	415/500	415/500	415/500	415/500	540/620	540/620		
Material of Blades	SKD11	SKD11	SKD11	SKD11	SKD11	SKD11	SKD11		
Quantity of Fixed Blades	2	2	2	2	2	2	4		
Quantity of Rotating Blades	3 x 2	3 x 3	3 x 4	3	3	6	6		
Cutting Chamber	mm	230 x 240	230 x 360	230 x 480	300 x 480	300 x 600	360 x 500	360 x 750	
	inch	9.0 x 9.4	9.0 x 14.2	9.0 x 18.9	11.8 x 18.9	11.8 x 23.6	14.2 x 19.7	14.2 x 29.5	
Max. Output	kg/hr	90	120	150	185	220	620	800	
	lb/hr	198	265	331	408	485	1367	1764	
Noise Level dB(A)	105-110	105-110	105-110	105-110	105-110	110-115	110-115		
Screen	mm							(φ8)	
	inch							(φ0.31)	
Dimension	H	mm	1390	1390	1390	1430	1430	1750	1750
		inch	54.7	54.7	54.7	56.3	56.3	68.9	68.9
	H1	mm	1320	1320	1320	1330	1330	1570	1570
		inch	52.0	52.0	52.0	52.7	52.7	61.8	61.8
	W	mm	590	710	830	830	950	1250	1500
		inch	23.2	28.0	32.7	32.7	37.4	49.2	59.0
	W1	mm	240	360	480	480	600	500	750
		inch	9.4	14.2	18.9	18.9	23.6	19.7	29.5
	D	mm	1130	1130	1130	1200	1200	1350	1450
		inch	44.5	44.5	44.5	47.2	47.2	53.1	57.0
	D1	mm	890	890	890	1000	1000	1100	1400
		inch	35.0	35.0	35.0	39.4	39.4	43.3	55.1
Weight	kg	320	380	450	500	530	1120	1360	
	lb	705	838	992	1102	1168	2469	2998	

Notes:1) SKD11 is steel grade of Japanese JIS standard.

2) Max. capacity of the machine is subject to diameter of screen mesh and composition of the material.

3) Noise level varies with different materials and motor types.

4) To avoid plastic from sticking to the blades, all materials should be crushed at normal temperature.

5) Power supply: 3Φ, 230/400/460/575VAC, 50/60Hz.