

储料桶 & 吸料盒

MST



■ 编码原则

MST-XXX (S/C)



■ 本机特点

- 桶体材质为SUS201，经久耐用
- 储料桶MST为圆形结构，储料桶MST-S/C为四方形结构
- MST-S专用于SSC螺旋输送机使用
- MST-50C顶盖为整体式，可方便取下加料，MST-100C~500C顶盖为两片式，一片固定一片合页连接，可方便打开加料
- MST&MST-C标准配备欧化吸料盒（1.5"单管），方便物料输送



MST



MST-C



MST-S

■ 应用范围

主要用于原料的储存，可放置于原料房或成型机边；亦可与粉碎机搭配使用，暂存粉碎机输送出来的物料，保证回收料连续立即回收使用。

储料桶MST&MST-C标配1.5"欧化吸料盒，也可选装其它规格欧化或截料式吸料盒。储料桶MST-S专用于SSC螺旋输送机使用。

■ 选装件

储料桶MST&MST-C原料接触部分抛光处理，机型后加注“P”

储料桶MST桶体改为不锈钢SUS304材质，机型后加注“S304”

储料桶

外形尺寸

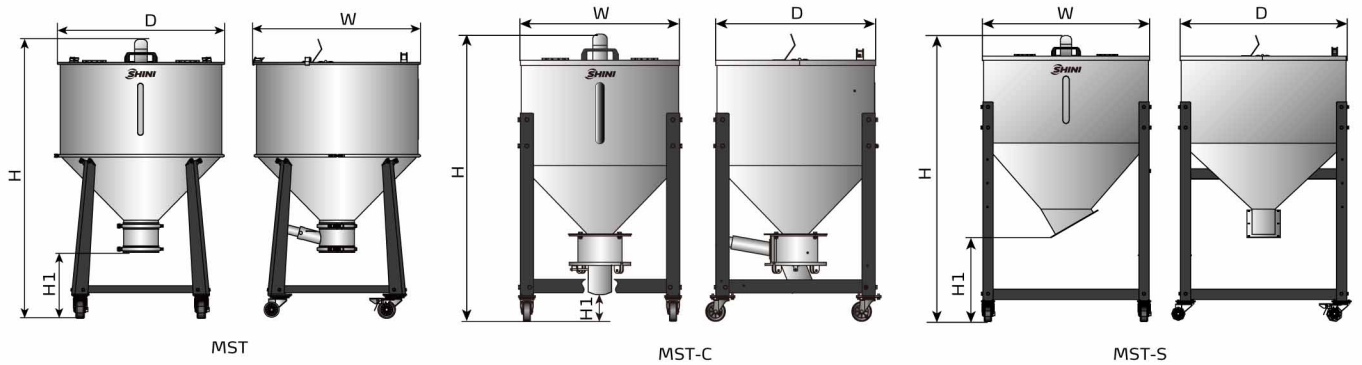

规格表

型号	储料桶容量 (kg)*	外形尺寸(mm) H × H1 × W × D	搭配SBU	净重 (kg)
MST-50	50	1080×275×585×585	SBU-50系列	28.5
MST-100	100	1210×290×740×740	SBU-100系列	32.5
MST-200	200	1330×285×890×890		43.5

型号	储料桶容量 (kg)*	外形尺寸(mm) H × H1 × W × D	搭配SBU	净重 (kg)
MST-50C	50	885×140×520×545	SBU-20系列	30
MST-100C	100	1095×110×625×655	SBU-160系列	48
MST-200C	200	1170×105×825×855		62
MST-500C	500	1585×190×1260×1275		105

型号	储料桶容量 (kg)*	外形尺寸(mm) H × H1 × W × D	净重 (kg)
MST-100S	100	1290×390×625×625	52
MST-200S	200	1390×410×825×825	66
MST-300S	300	1640×390×950×950	80
MST-500S	500	1730×420×1250×1250	110

注: 1) "*"表示以堆积密度为0.65kg/L, 直径为3~5mm塑胶原料颗粒计算
2) 特殊规格要求可定制

■ 编码原则

SBU-xxx-xx-x-V-x

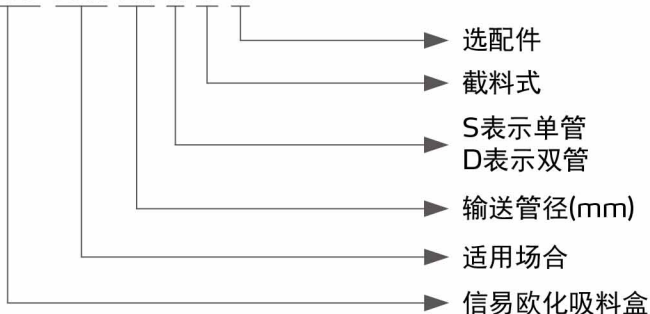

■ 本机特点

- 独特的内部结构，保证原料顺畅输送
- 标准吸料盒设计补气孔，简洁易用；截料式吸料盒配备补风管，易于形成死循环输送,避免管路堵塞
- SBU-20/160吸料盒为铝材质，一体成型；SBU-50/100吸料盒为不锈钢材质



SBU-20/160-S



SBU-20/160-D



SBU-20/160-S-V

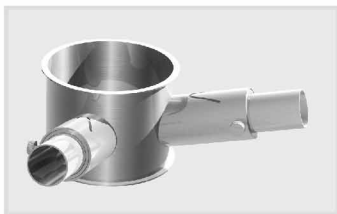

SBU-50/100-D

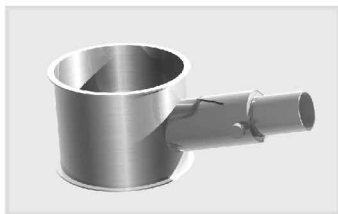

SBU-50/100-S



SBU-50/100-S-V

■ 选配件

- SBU-20/160可选配不锈钢材质，机型后加注“S”
- 当选配不锈钢材质，原料接触部分可抛光处理，机型后加注“P”

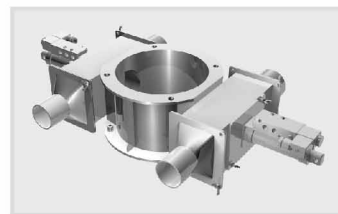

SBU-160-63D-V

■ 应用范围

SBU-20/160安装于干燥桶或其他储料设备的下部，SBU-50/100安装于储料桶的下部，用于搭配负压输送系统对原料进行输送，标准吸料盒适用于原料短距离输送场合，截料式吸料盒配备了截料功能，当输送干燥后的原料或原料进行远距离输送时，截料功能可保证料管中无残余原料，避免原料回潮或堵塞管道。

■ 外形尺寸

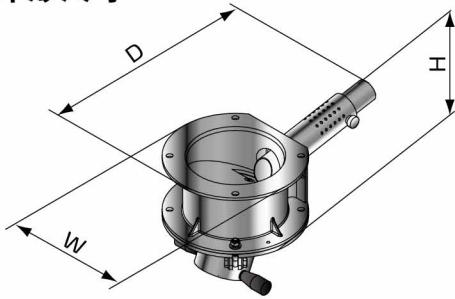

SBU-20/160-S

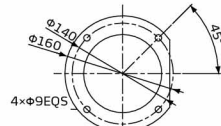

SBU-20

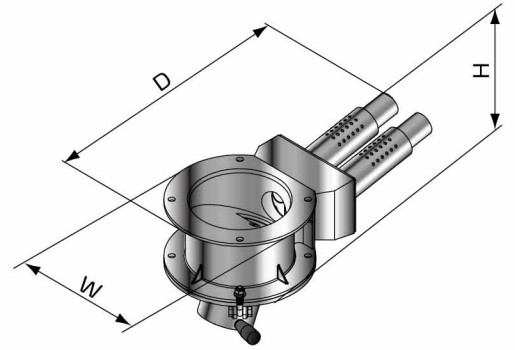

SBU-20/160-D

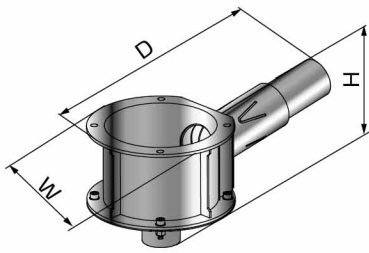

SBU-160-63S

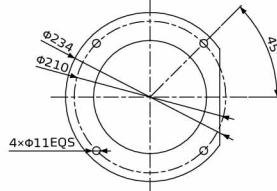

SBU-160

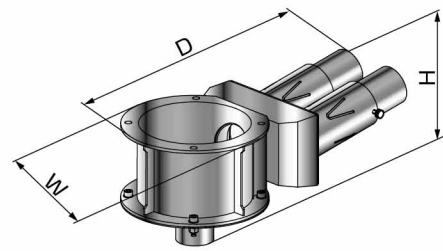

SBU-160-63D

机型	H×W×D(mm)
SBU-20-38S	210×180×390
SBU-20-50S	210×180×390
SBU-160-38S	235×235×435
SBU-160-50S	235×235×450
SBU-160-63S	197×234×468

机型	H×W×D(mm)
SBU-20-38D	200×180×414
SBU-20-50D	200×180×414
SBU-160-38D	230×235×485
SBU-160-50D	230×235×480
SBU-160-63D	197×234×507

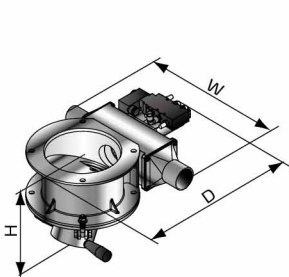

SBU-20/160-S-V

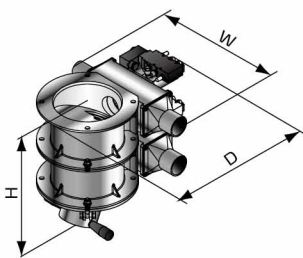

SBU-20/160-D-V

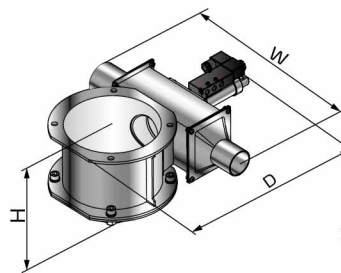

SBU-160-63S-V

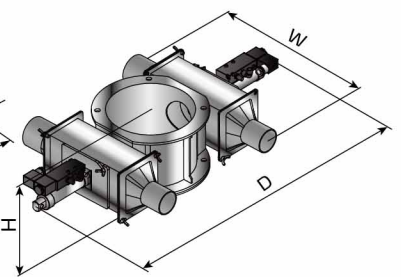

SBU-160-63D-V

机型	H×W×D(mm)
SBU-20-38S-V	200×330×370
SBU-20-50S-V	200×330×370
SBU-160-38S-V	230×330×440
SBU-160-50S-V	230×330×440
SBU-160-63S-V	200×365×473

机型	H×W×D(mm)
SBU-20-38D-V	315×330×370
SBU-20-50D-V	315×330×370
SBU-160-38D-V	347×330×440
SBU-160-50D-V	347×330×440
SBU-160-63D-V	200×365×670

吸料盒

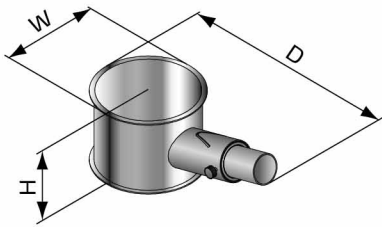

SBU-50/100-S

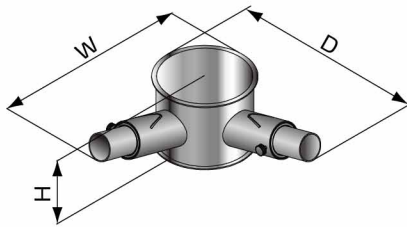

SBU-50/100-D

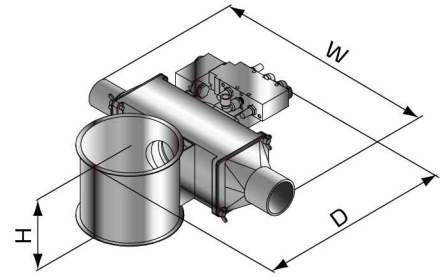

SBU-50/100-S-V

机型	H×W×D (mm)
SBU-50-38S	122×138×315
SBU-50-50S	122×138×315
SBU-100-38S	122×162×340
SBU-100-50S	122×162×340
SBU-100-63S	142×162×350

机型	H×W×D (mm)
SBU-50-38D	122×315×315
SBU-50-50D	122×315×315
SBU-100-38D	122×340×340
SBU-100-50D	122×340×340
SBU-100-63D	142×350×350

机型	H×W×D (mm)
SBU-50-38S-V	125×320×385
SBU-50-50S-V	125×320×385
SBU-100-38S-V	125×320×410
SBU-100-50S-V	125×320×410
SBU-100-63S-V	145×365×425
SBU-100-63D-V	145×365×660

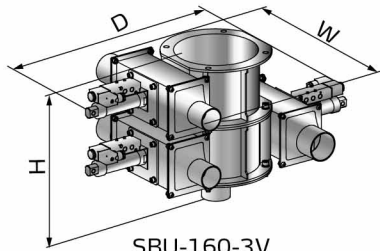

SBU-160-3V

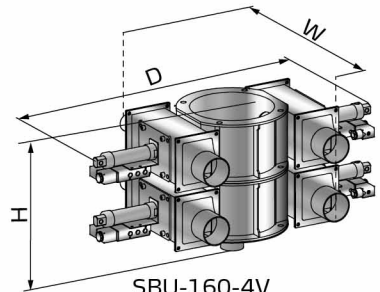

SBU-160-4V

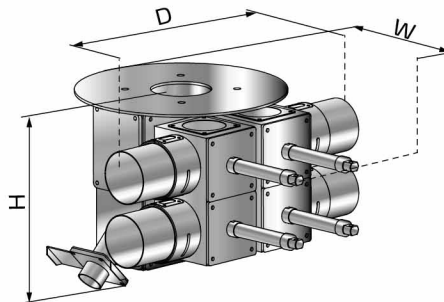

SBU-160-4V-2.5/3/4

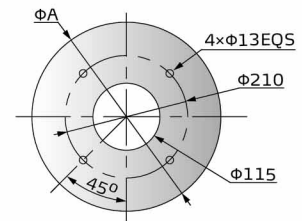

机型	H×W×D (mm)
SBU-160-3V	329×363×663
SBU-160-4V	329×363×663

机型	H×W×D (mm)	ΦA (mm)
SBU-160-4V-2.5	266×472×454	324
SBU-160-4V-3	310×489×458	324
SBU-160-4V-4	345×583×575	400

信易集团

地址: 台湾省新北市树林区民和街23号

电话: +886 2 2680 9119

传真: +886 2 2680 9229

Email: shini@shini.com