

## 储料桶 & 吸料盒

MST



# 储料桶

## ■ 编码原则

MST-XXX (S/C)

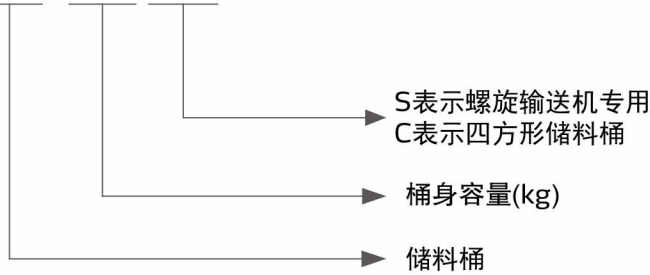

## ■ 本机特点

- 桶体材质为SUS201，经久耐用
- 储料桶MST为圆形结构，储料桶MST-S/C为四方形结构
- MST-S专用于SSC螺旋输送机使用
- MST-50C顶盖为整体式，可方便取下加料，MST-100C~500C顶盖为两片式，一片固定一片合页连接，可方便打开加料
- MST-C标准配备欧化吸料盒（单管），方便物料输送



MST



MST-S



MST-C

## ■ 应用范围

主要用于原料的储存，可放置于原料房或成型机边；亦可与粉碎机搭配使用，暂存粉碎机输送出来的物料，保证回收料连续立即回收使用。

储料桶MST&MST-C标配1.5"欧化吸料盒，也可选装其它规格欧化或截料式吸料盒。储料桶MST-S专用于SSC螺旋输送机使用。

## ■ 选装件

储料桶MST&MST-C原料接触部分抛光处理，机型后加注“P”

# 储料桶

## 外形尺寸

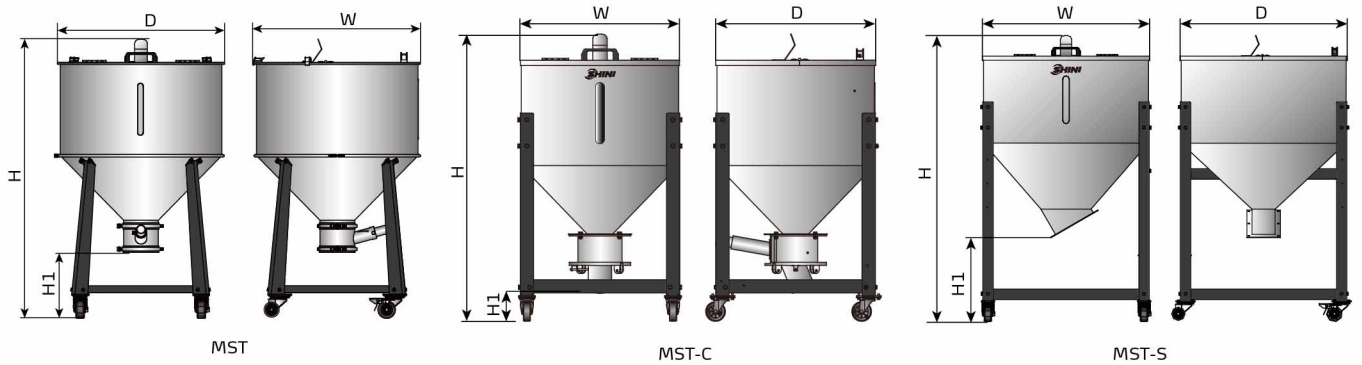

## 规格表

型 号	储料桶容量 (kg)*	外形尺寸(mm) H × H <sub>1</sub> × W × D	搭配SBU	净重 (kg)
MST-50	50	990×273×580×580	SBU-50系列	28.5
MST-100	100	1100×286×750×750	SBU-100系列	32.5
MST-200	200	1170×284×910×910		43.5

型 号	储料桶容量 (kg)*	外形尺寸(mm) H × H <sub>1</sub> × W × D	搭配SBU	净重 (kg)
MST-50C	50	885×144×519×543	SBU-20系列	30
MST-100C	100	1093×106×625×651	SBU-160系列	48
MST-200C	200	1169×102×825×851		62
MST-500C	500	1582×149×1259×1274		105

型 号	储料桶容量 (kg)*	外形尺寸(mm) H × H <sub>1</sub> × W × D	净重 (kg)
MST-100S	100	1180×387×615×615	52
MST-200S	200	1290×408×815×815	66
MST-300S	300	1540×388×930×930	80
MST-500S	500	1630×417×1240×1240	110

注: 1) "\*"表示以堆积密度密度为0.65kg/L, 直径为3~5mm塑胶原料颗粒计算  
2) 特殊规格要求可定制

## ■ 編碼原則

SBU-xxx-xx-x-V-x

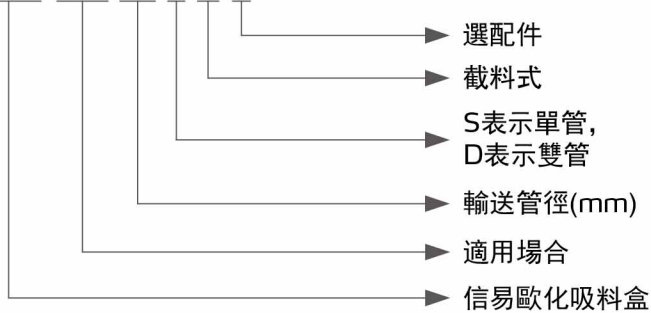

## ■ 本機特點

- 獨特的內部結構，保證原料順暢輸送
- 標準吸料盒設計補氣孔，簡潔易用；截料式吸料盒配備補風管，易於形成閉環輸送，避免管路堵塞
- SBU-20/160吸料盒為鋁材質，一體成型；SBU-50/100吸料盒為不銹鋼材質



SBU-20/160-S



SBU-20/160-D

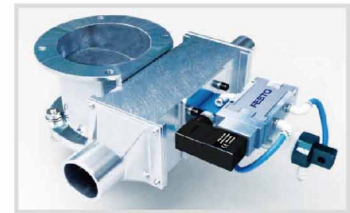

SBU-20/160-S-V

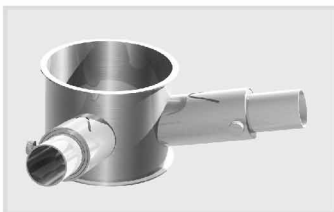

SBU-50/100-D

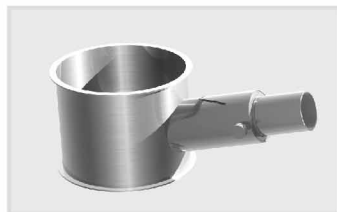

SBU-50/100-S



SBU-50/100-S-V

## ■ 選配件

- SBU-20/160可選配不銹鋼材質，機型後加注“S”
- 當選配不銹鋼材質，原料接觸部分可拋光處理，機型後加注“P”

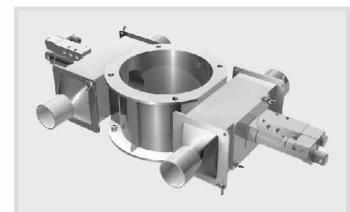

SBU-160-63D-V

## ■ 應用範圍

SBU-20/160安裝於乾燥桶或其他儲料設備的下部，SBU-50/100安裝于儲料桶的下部，用於搭配負壓輸送系統對原料進行輸送，標準吸料盒適用於原料短距離輸送場合，截料式吸料盒配備了截料功能，當輸送乾燥後的原料或原料進行遠距離輸送時，截料功能可保證料管中無殘餘原料，避免原料回潮或堵塞管道。

■ 外形尺寸

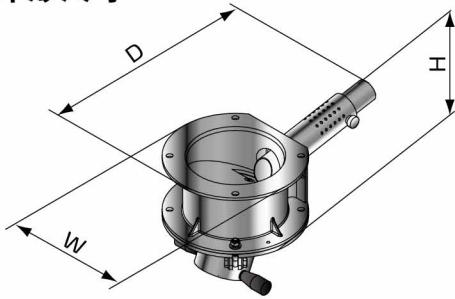

SBU-20/160-S

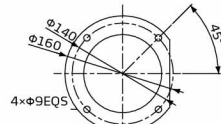

SBU-20

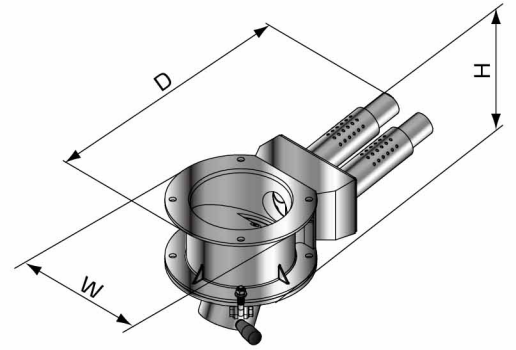

SBU-20/160-D

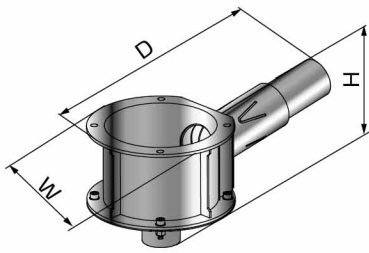

SBU-160-63S

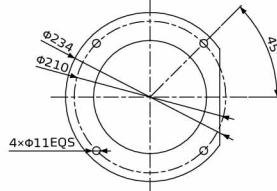

SBU-160

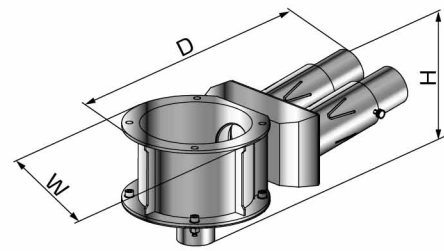

SBU-160-63D

机型	H×W×D(mm)
SBU-20-38S	210×180×390
SBU-20-50S	210×180×390
SBU-160-38S	235×235×435
SBU-160-50S	235×235×450
SBU-160-63S	197×234×468

机型	H×W×D(mm)
SBU-20-38D	200×180×414
SBU-20-50D	200×180×414
SBU-160-38D	230×235×485
SBU-160-50D	230×235×480
SBU-160-63D	197×234×507

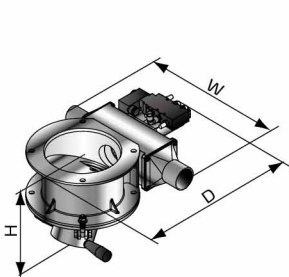

SBU-20/160-S-V

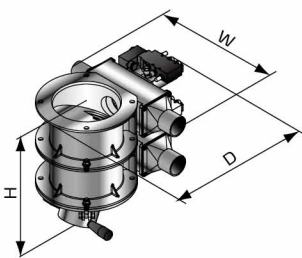

SBU-20/160-D-V

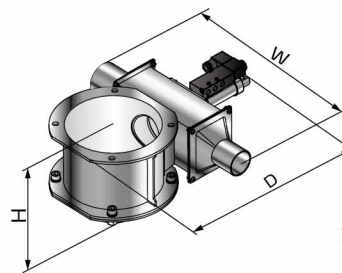

SBU-160-63S-V

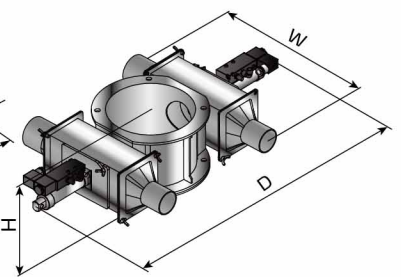

SBU-160-63D-V

机型	H×W×D(mm)
SBU-20-38S-V	200×330×370
SBU-20-50S-V	200×330×370
SBU-160-38S-V	230×330×440
SBU-160-50S-V	230×330×440
SBU-160-63S-V	200×365×473

机型	H×W×D(mm)
SBU-20-38D-V	315×330×370
SBU-20-50D-V	315×330×370
SBU-160-38D-V	347×330×440
SBU-160-50D-V	347×330×440
SBU-160-63D-V	200×365×670

# 吸料盒

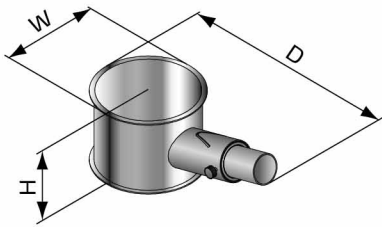

SBU-50/100-S

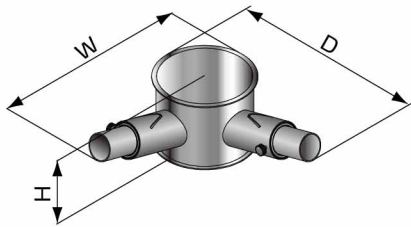

SBU-50/100-D

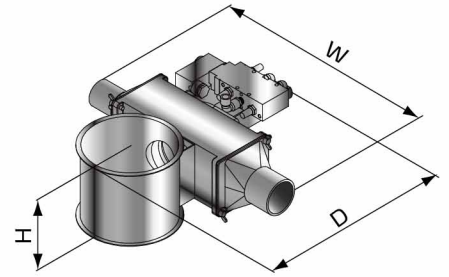

SBU-50/100-S-V

机型	H×W×D(mm)
SBU-50-38S	122×138×315
SBU-50-50S	122×138×315
SBU-100-38S	122×162×340
SBU-100-50S	122×162×340
SBU-100-63S	142×162×350

机型	H×W×D(mm)
SBU-50-38D	122×315×315
SBU-50-50D	122×315×315
SBU-100-38D	122×340×340
SBU-100-50D	122×340×340
SBU-100-63D	142×350×350

机型	H×W×D(mm)
SBU-50-38S-V	125×320×385
SBU-50-50S-V	125×320×385
SBU-100-38S-V	125×320×410
SBU-100-50S-V	125×320×410
SBU-100-63S-V	145×365×425
SBU-100-63D-V	145×365×660

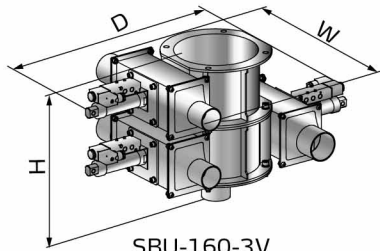

SBU-160-3V

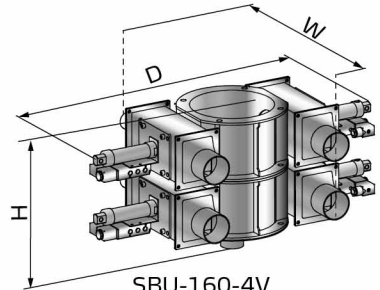

SBU-160-4V

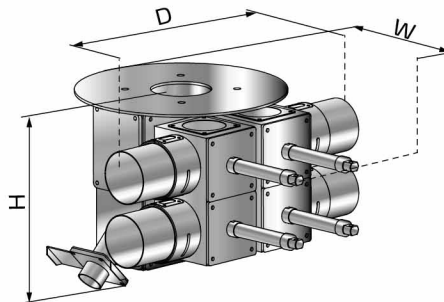

SBU-160-4V-2.5/3/4

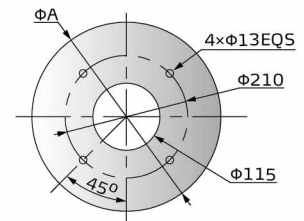

机型	H×W×D(mm)
SBU-160-3V	329×363×663
SBU-160-4V	329×363×663

机型	H×W×D(mm)	ΦA (mm)
SBU-160-4V-2.5	266×472×454	324
SBU-160-4V-3	310×489×458	324
SBU-160-4V-4	345×583×575	400

信易集团

地址: 台湾省新北市树林区民和街23号

电话: +886 2 2680 9119

传真: +886 2 2680 9229

Email: shini@shini.com