

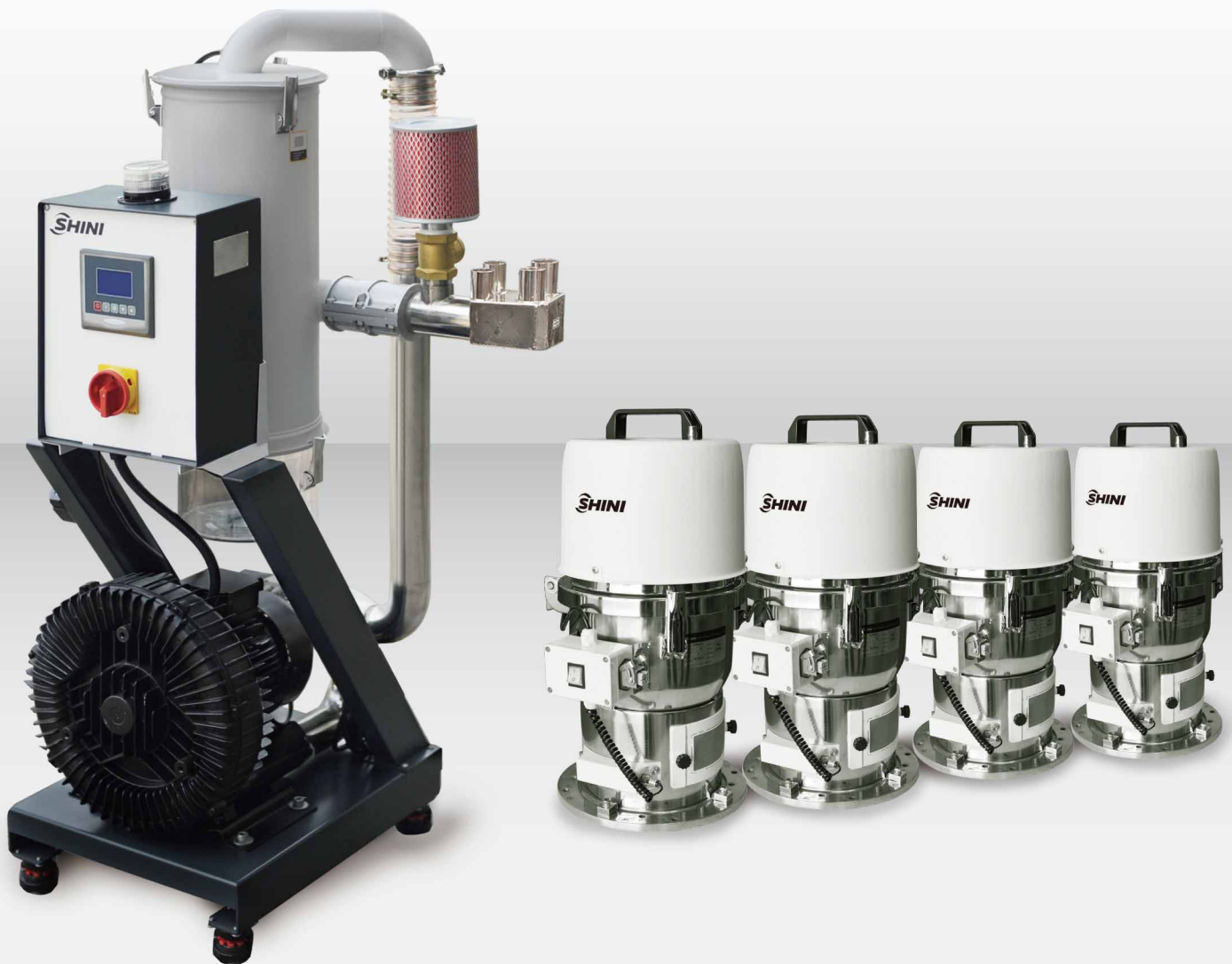

"Multi-station" Hopper Loader

SAL-5HP-UG124 & SHR-12U-S



Refer carefully to the manual before operation.

SAL-UG122/UG124 Series

Coding Principle

SAL - xxHP - UG122/124 - D -xx

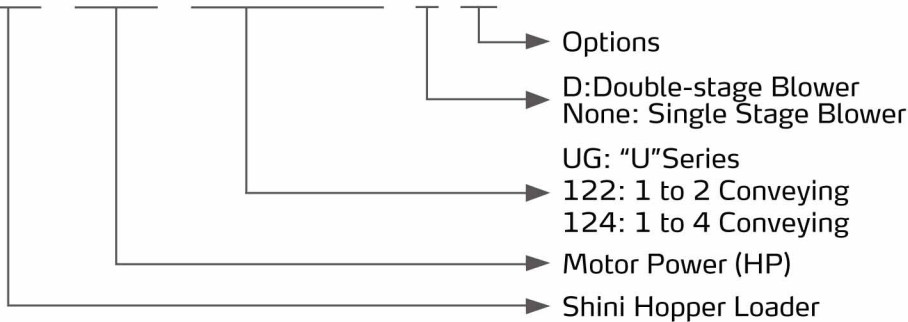

Features

- LED touch panel for simple operation
- One main vacuum unit for 2 or 4 hopper receivers, suitable for height or long-distance conveying.
- Two-stage cyclone and filter technology with large dust bin for quick and easy maintenance.
- Standard vacuum breaking valve for quick material discharge, maximize load, and energy consumption.
- 5HP and above models are equipped with auto spraying device to reduce the cleaning frequency
- Standard 485 interface for remote monitoring to realize auto production



Vacuum breaking valve

Application

Collocated with two or four European vacuum hopper receivers SHR-U-S, it is suitable for conveying plastic materials of several dehumidifying dryers (such as two-in-one SDD). Besides, the machine also can achieve "One-to-Two" or "One-to-Four" material conveying to different injection moulding machines or hoppers, thus greatly saving the costs.

Conveying Capacity (SAL-UG122)

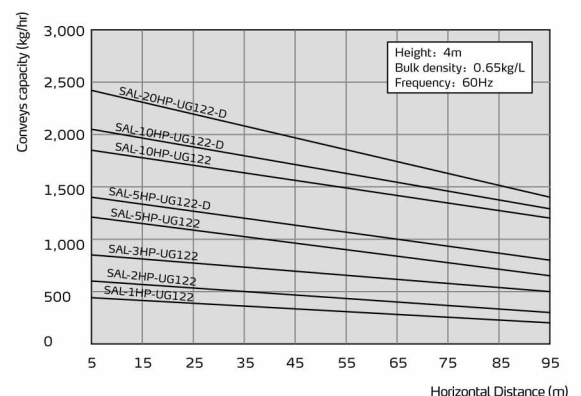
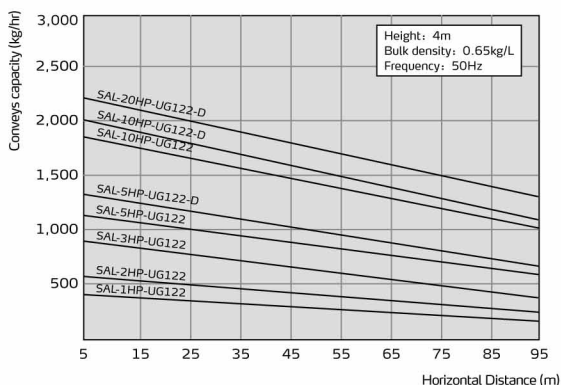

SAL-UG122/124 Series

Conveying Capacity (SAL-UG124)

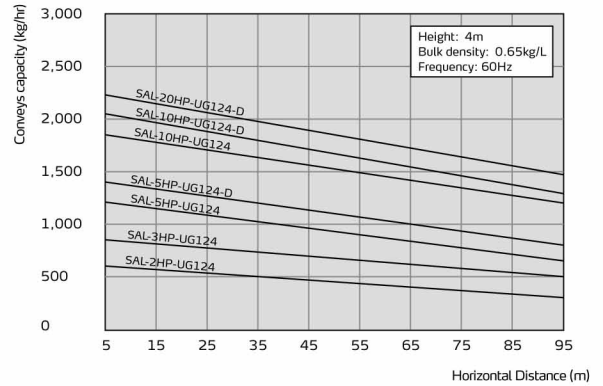
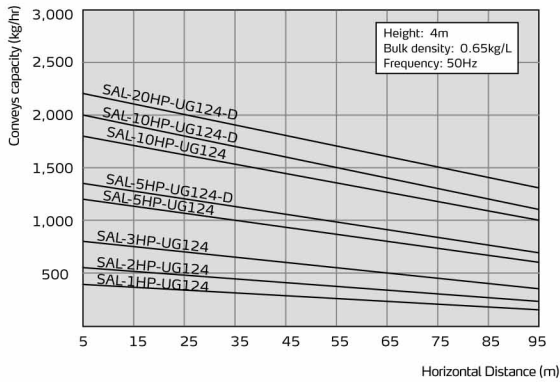

SAL-UG122 Outline Drawing

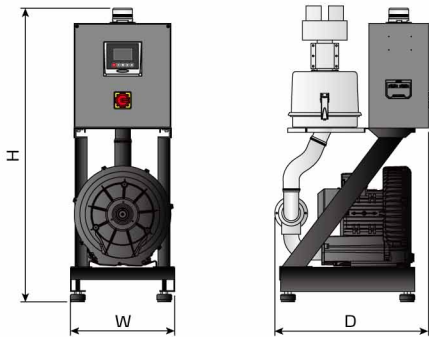

SAL-1HP/2HP/3HP-UG122

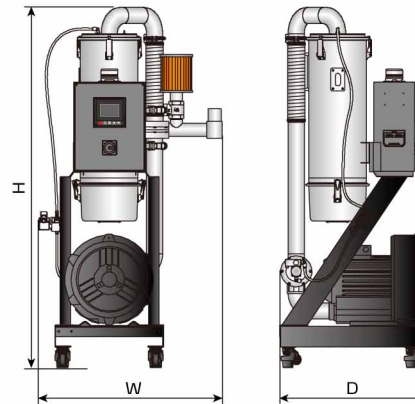

SAL-5HP-UG122(-D)

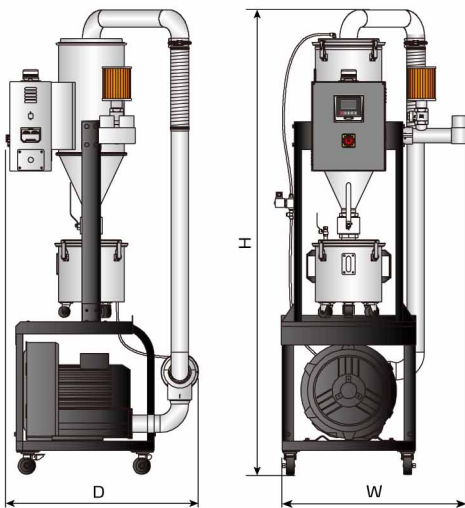

SAL-10HP-UG122(-D)

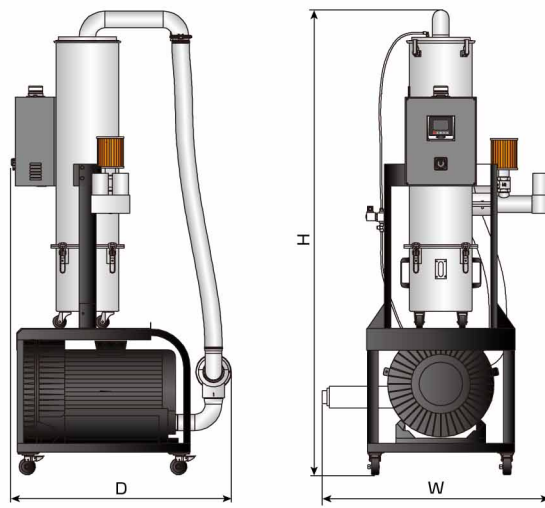

SAL-20HP-UG122-D

SAL-UG124 Outline Drawing

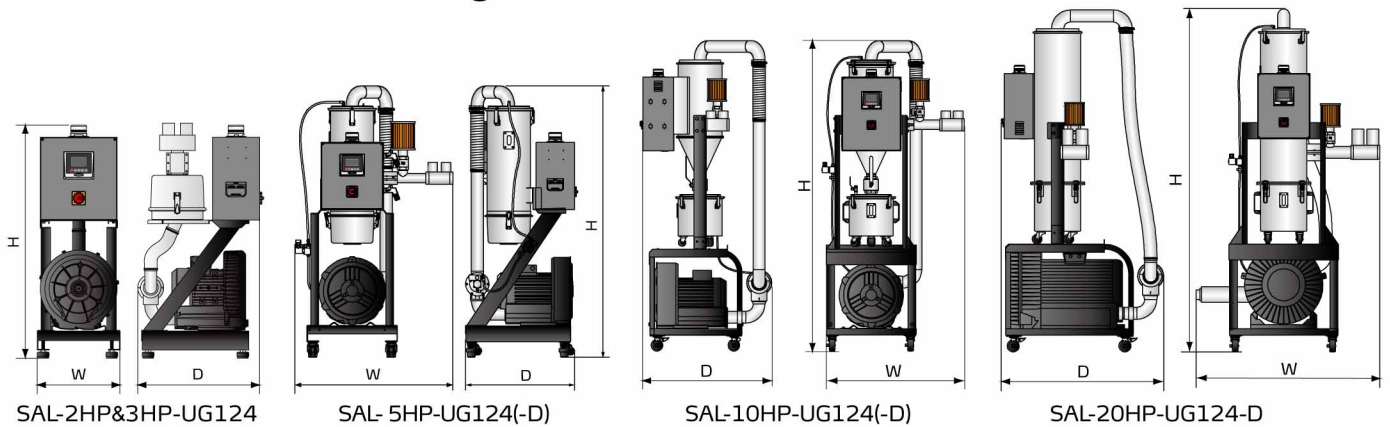

SAL-UG122 Specifications

Model	Motor Power (kW, 50/60Hz)	Dimension (mm) H × W × D	Weight (kg)	Applied to	Conveying Pipe Dia. (inch)	Vacuum Pipe Dia. (inch)	Conveying Capacity(kg/hr) (50/60Hz)
SAL-1HP-UG122	0.75/0.85	990 × 350 × 488	52	2 × SHR-3U-S	1.5	2	400/440
SAL-2HP-UG122	1.5/1.8	990 × 350 × 488	56	2 × SHR-6U-S	1.5	2	550/600
SAL-3HP-UG122	1.85/2.0	990 × 350 × 488	60	2 × SHR-12U-S	1.5	2	800/850
SAL-5HP-UG122	3.75/4.2	1410 × 720 × 570	175	2 × SHR-12U-S	1.5	2	120/1210
SAL-5HP-UG122-D	3.0/3.35	1410 × 720 × 570	180	2 × SHR-12U-S			1350/1400
SAL-10HP-UG122	7.5/8.6	2020 × 840 × 820	185	2×SHR-24U/36U-S	2	2.5	1800/1850
SAL-10HP-UG122-D		2020 × 980 × 820	192	2×SHR-24U/36U-S			2000/2050
SAL-20HP-UG122-D	11/12.3	2145 × 1055 × 1000	246	2×SHR-48U/96U-S	2.5	3	2200/2420

Notes: 1) Test condition of conveying capacity: Plastic material of bulk density 0.65kg/L
 dia. 3-5mm, vertical conveying height: 4m, horizontal conveying distance: 5m.
 2) Power supply: 3Φ, 230/400/460/575V, 50/60Hz.

SAL-UG124 Specifications

Model	Motor Power (kW, 50/60Hz)	Dimension (mm) H × W × D	Weight (kg)	Applied to	Conveying Pipe Dia. (inch)	Vacuum Pipe Dia. (inch)	Conveying Capacity(kg/hr) (50/60Hz)
SAL-2HP-UG124	1.5/1.08	990 × 350 × 533	60	4 × SHR-3U-S	1.5	2	550/600
SAL-3HP-UG124	1.85/2.0		65	4 × SHR-6U-S			800/850
SAL-5HP-UG124	3.75/4.2	1410 × 825 × 585	175	4 × SHR-12U-S	1.5	2	1200/1210
SAL-5HP-UG124-D	3.0/3.35	1410 × 825 × 585	180	4 × SHR-12U-S			1350/1400
SAL-10HP-UG124	7.5/8.6	2020 × 930 × 855	185	4×SHR-24U/36U-S	2	2.5	1800/1850
SAL-10HP-UG124-D		2020 × 1065 × 855	192	4×SHR-24U/36U-S			2000/2050
SAL-20HP-UG124-D	11/12.3	2145 × 1150 × 1000	246	4×SHR-48U/96U-S	2.5	3	2200/2250

Notes: 1) Test condition of conveying capacity: Plastic material of bulk density 0.65kg/L
 dia. 3-5mm, vertical conveying height: 4m, horizontal conveying distance: 5m.
 2) Power supply: 3Φ, 230/400/460/575V, 50/60Hz.

Shini Group

Addr: No. 23, Minhe St., Shulin Dist.,
New Taipei, Taiwan

Tel: +886 2 2680 9119

Fax: +886 2 2680 9229

Email: shini@shini.com

Factories:

- Taiwan
- Dongguan
- Pinghu
- Ningbo
- Chongqing
- Pune