



# Systematic Solution

Simple Solution



Shini group is able to help you on whole plant planning: conveying, drying, dosing temperature control and system cooling, automation and recycling for injection application or extrusion application.

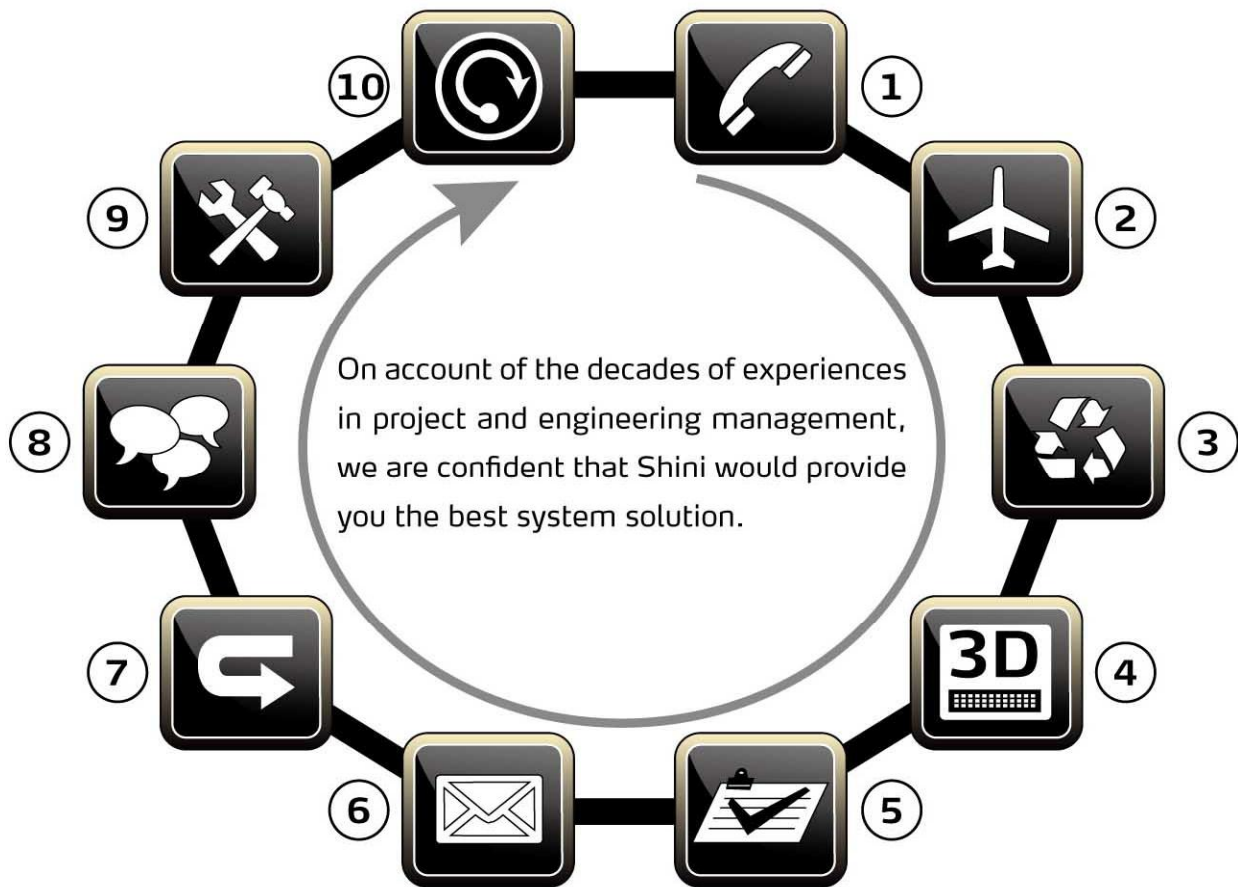

- |                                 |                           |                              |
|---------------------------------|---------------------------|------------------------------|
| 1. Demand Survey                | 2. Checking on the Scene  | 3. System Planning           |
| 4. Diagram of 3D Layout         | 5. Confirming Regulations | 6. Purchasing Contract       |
| 7. System Architectural Drawing | 8. Project Conference     | 9. Installation & Acceptance |
| 10. Follow-up Survey            |                           |                              |



**Our Strengths**

With decades of accumulation, we can speak proudly that Shini possesses a leading engineering team in plastics auxiliary equipment industry in China which can be seen in their affluent experience, increasing turnover and perfect organization. No matter where, Shini is trustworthy.

**Our Commitments**

We realize that the customer needs is more effective and stable products. Shini Engineering Team takes part in all stages of customers' programs, from regulations confirming to system designing, installing, adjusting, trouble-shooting and to maintaining, providing customers service from start to finish, thus to ensure continuous and smooth operation.

**Shini is always there to help you enhance effectiveness and improve quality as well as enhance your competitiveness in marketing. Shini is able to cater to different needs by providing customized material handling solutions.**

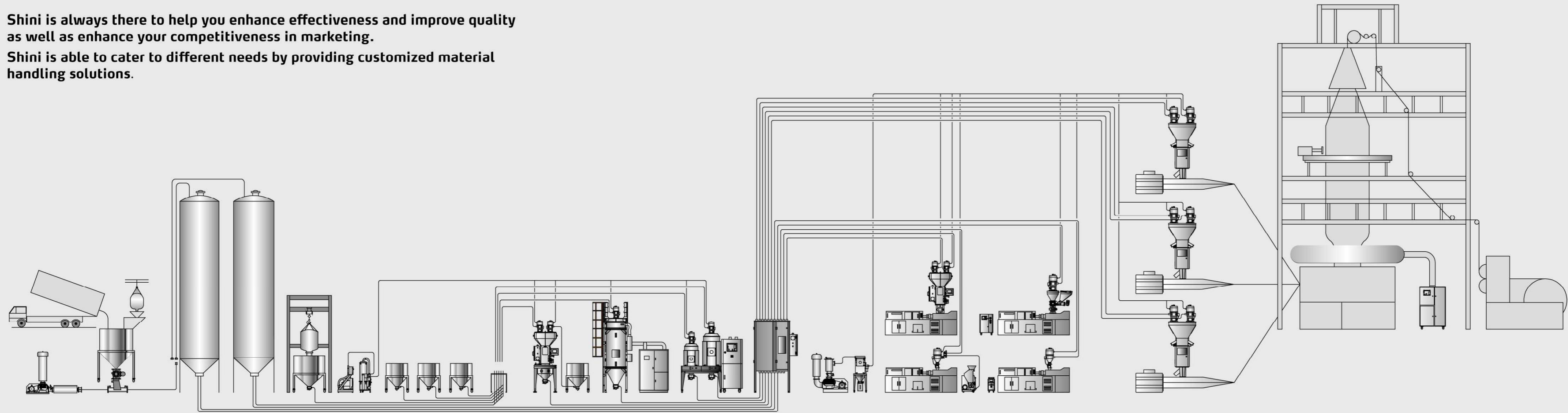

**Storage**



**Conveying**



**Distribution**



**Dosing and Mixing**



**Drying**

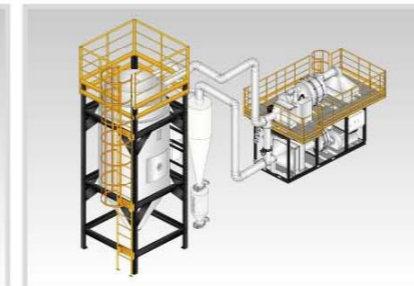

**Extrusion Control**



Central Material Handling System\_5

3\_Central Material Handling System

Central Material Handling System\_4

## Storage

For material storage, Shini can provide you large scale silos which are suitable for outdoor application, and small sized material tanks for regrinds and masterbatch materials. When container bags are used, Shini can also provide you relevant discharging and storage equipments.

Real-time monitoring of material level makes operation much more convenient.

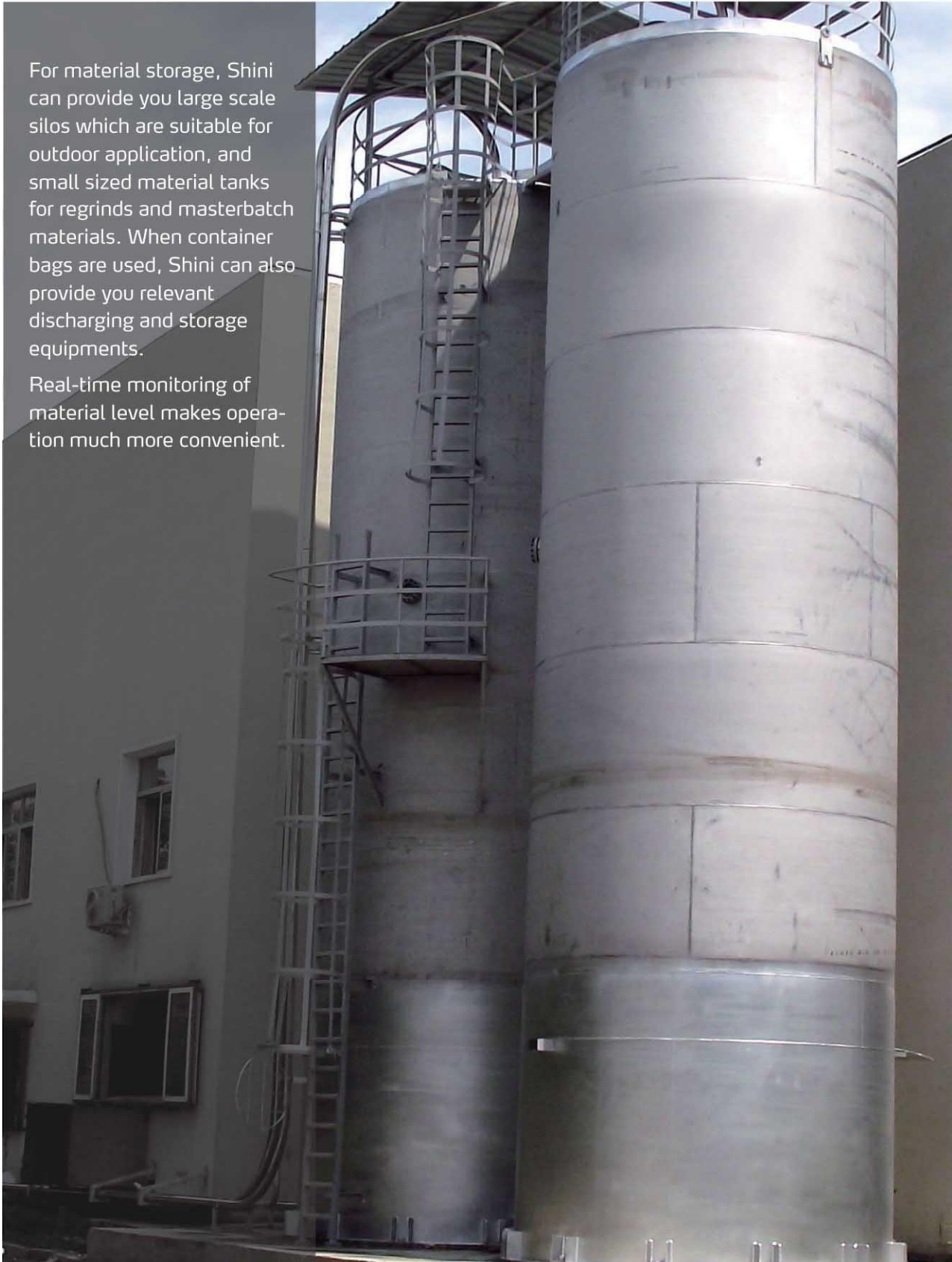

## Material Distribution

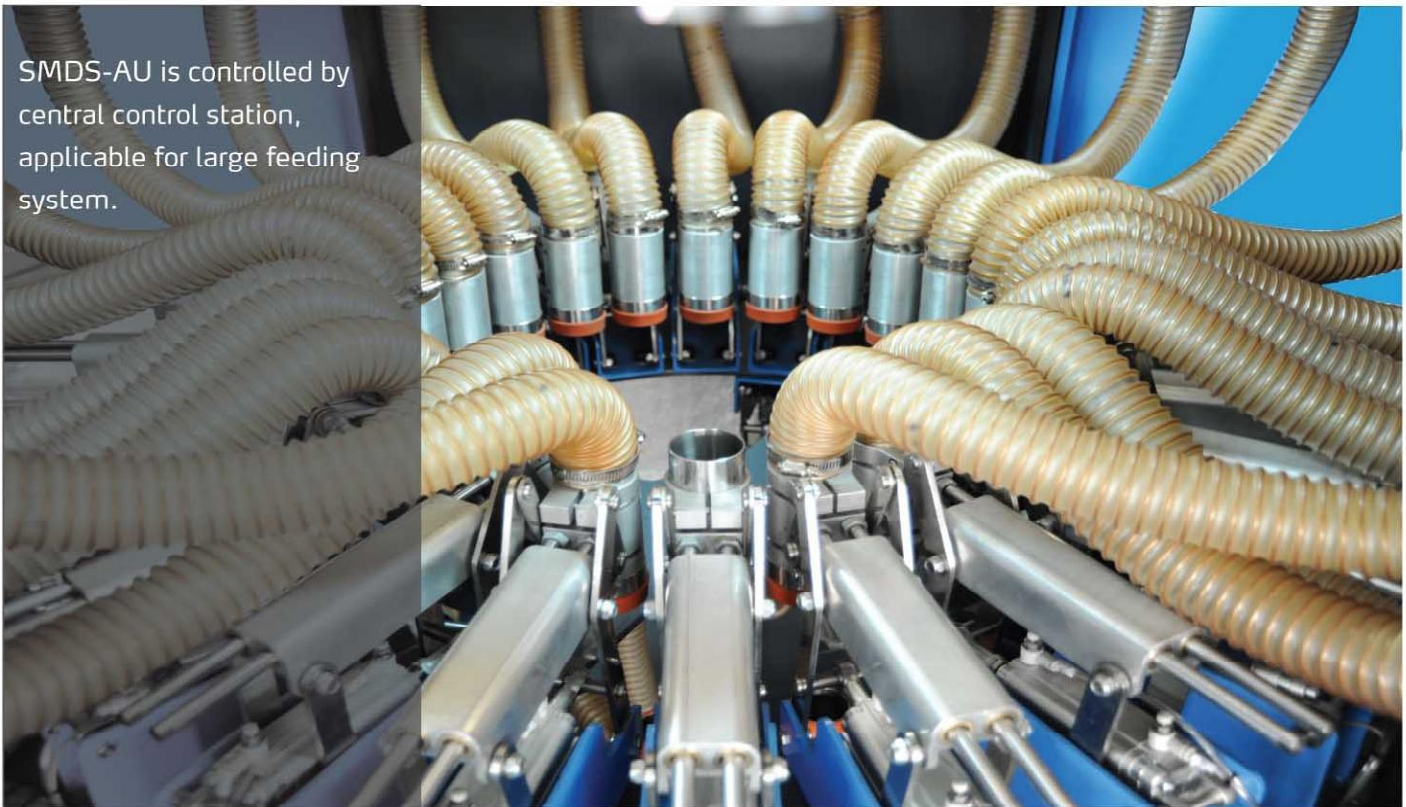

SMDS-AU is controlled by central control station, applicable for large feeding system.

## Dosing and Mixing

Gravimetric and loss-in-weight dosing system is applicable for precise dosing of granules and sheet materials with which product quality can be guaranteed.

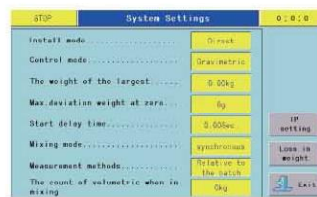

System Setting



Recipe Edit

- Throughput of Shini gravimetric blender is 40~3,000kg/hr with 2~8 ingredients.
- Special high temperature gravimetric design, together with gravimetric sensor and material level sensor, is suitable for PET crystalized material processing.
- Controller adopt Ethernet interface, with relevant software material proportion data (max. output, actual output, accuracy of proportion, etc.) can be viewed to control product quality.
- Auto calibration after each material weighing to ensure accuracy.
- With regrinds compensation function, aberration compensation can be automatically calculated based on feeding amount of regrinds.

- Bridge-breaking structure and feeding ensures continuity when processing sheet regrinds.

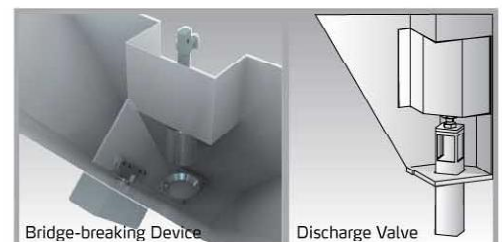

## Dehumidifying Drying System

Dehumidified Drying System is applied to the situations with large quantity of plastics and low dew-point. The system mainly consists of honeycomb rotor dehumidifier and heat insulated hopper dryer. After the drying process, the final moisture content of the dried material can be as low as 0.004%.

- Adopts the precise P.I.D. electric temperature control to achieve evenly drying.
- Double coolers ensuring low return air and dew-point.
- Hopper is made from stainless steel material, which avoids material contamination during dehumidifying.
- Equipped with overheat protection to avoid material agglomeration.
- Equipped with motor overload protection.
- Equipped with manual discharge valve, and pneumatic valve is optional.

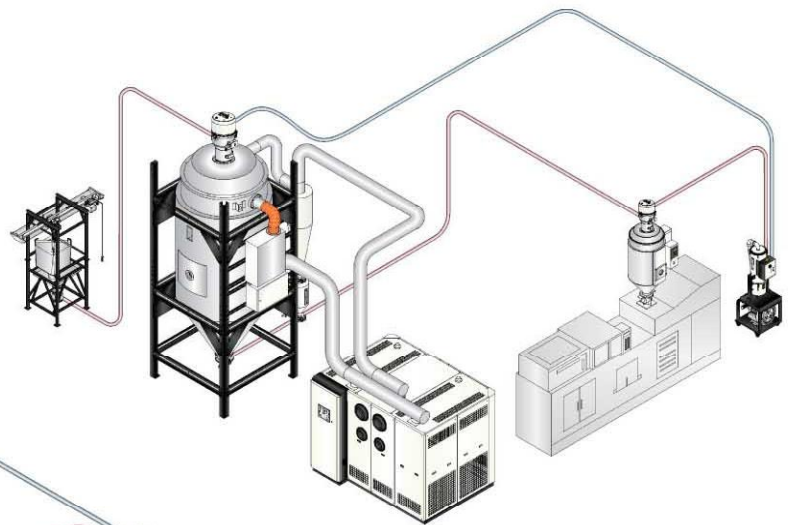

Floor Type

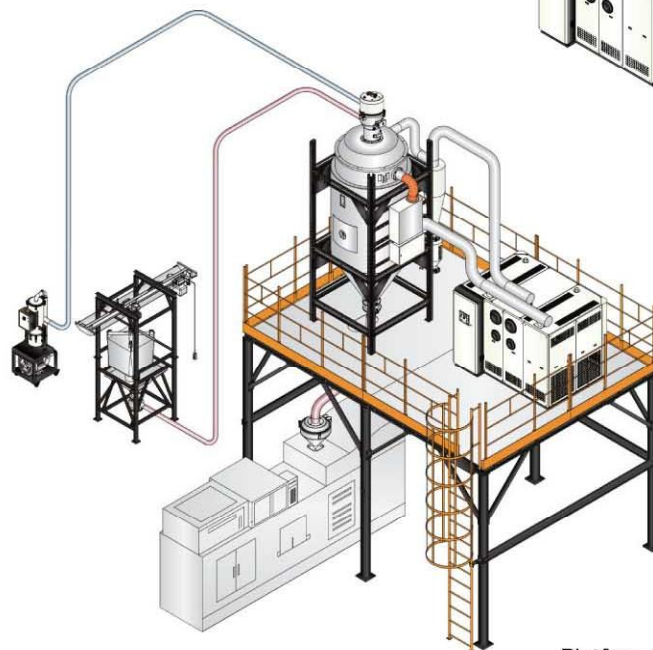

Platform Type

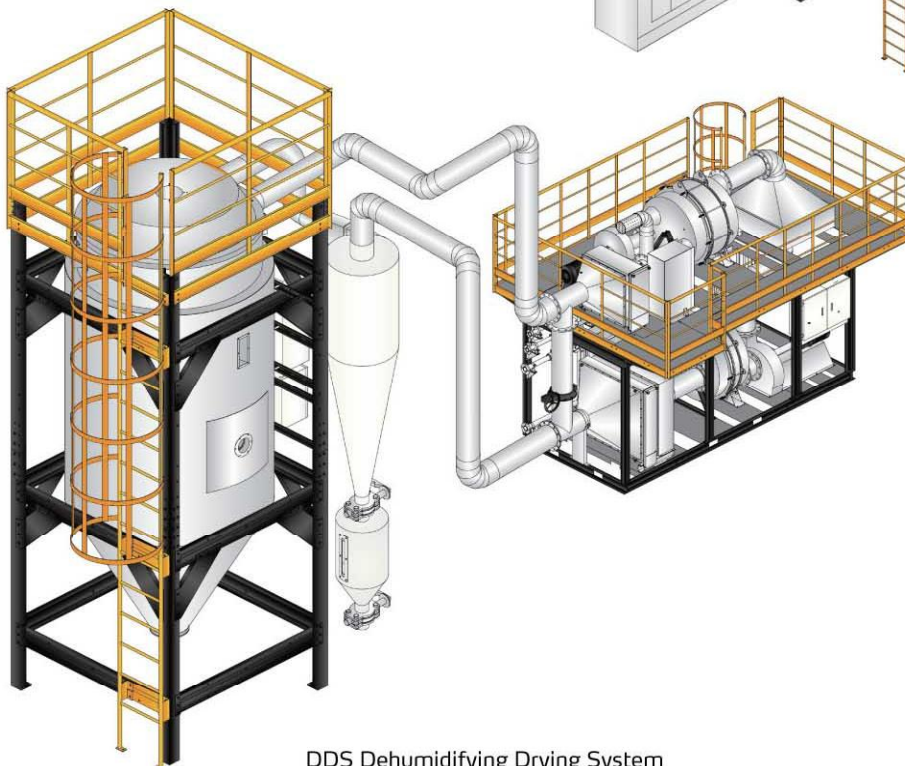

DDS Dehumidifying Drying System

- PLC controller with LCD touch is optional.
- Dew-point monitor is optional for real-time monitoring dehumidifying.
- Air heat exchanger is optional for realizing energy recycling and reducing energy consumption.
- Variable control of output quantity is optional, which achieves energy-saving by optimizing energy collocation based on actual demands.
- Dew-point setting is optional, which achieves energy-saving by auto adjusting regeneration temperature based on actual dew-point needed.

## Extrusion Blow Modling

The function of air ring is cooling mold bubble with air. Also the air ring can to some extent support the bubble. High-efficiency air ring can significantly increase the output of the extruder. Mold bubble being blown from the blowing molding machine is in molten which need to be cool down in time. Otherwise there will be a fall or adhesion when be rolled up. In addition, quick cooling of mold bubble can greatly improve the mechanical and optical properties of thin film products.



Automatic Air Ring

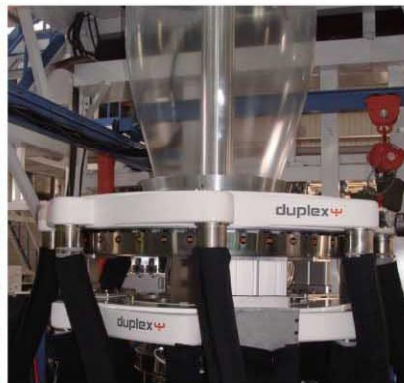

Double Air Ring



Counter Air Ring

### Loss-in-weight Hopper SYline

SYline is a gravimetric loss-in-weight hopper designed to gravimetrically feed the extruder throat controlling the throughput set. The weight of hopper and relevant material is weighted by two off-centre load cell. Based on commercial modular PLC electronics, SYline ensures simple and practical operation. Control softwares of SYline are loss-in-weight control, gram/meter and throughput control, material consumption control.



### Loss-in-weight Continuous Dosing System SYdos

SYdos is continuous loss-in-weight gravimetric dosing system designed to dose and feed multiple components in all process in which a constant gravimetric feeding is required. Main material is weighed by two off-centre load cells and the data is transferred to control system to adjust the screw speed with the data transferred by each load cells of other materials. Control software of SYdos consists of loss-in-weight control, gram/meter and throughput control and material consumption control.



### Gain-in-weight Batch Blender eaSYbatch

eaSYbatch is the traditional gain-in-weight batch blender, designed to dose and blend multiple components. Using modularized PLC technology, the simple and practical operation can be assured. Control software of eaSYbatch consists of loss-in-weight control, gram/meter and throughput control, material consumption control.



# Central Material Handling

## Central Control Station

SCCS series German made SIEMENS PLC controller with best design and powerful functions, it can efficiently control the system of dust cleaning, material conveying, alarming etc. The system has strong compatibility. Comply with "CE" standard to ensure safe operation. Easy to operate with humanized operation interface.

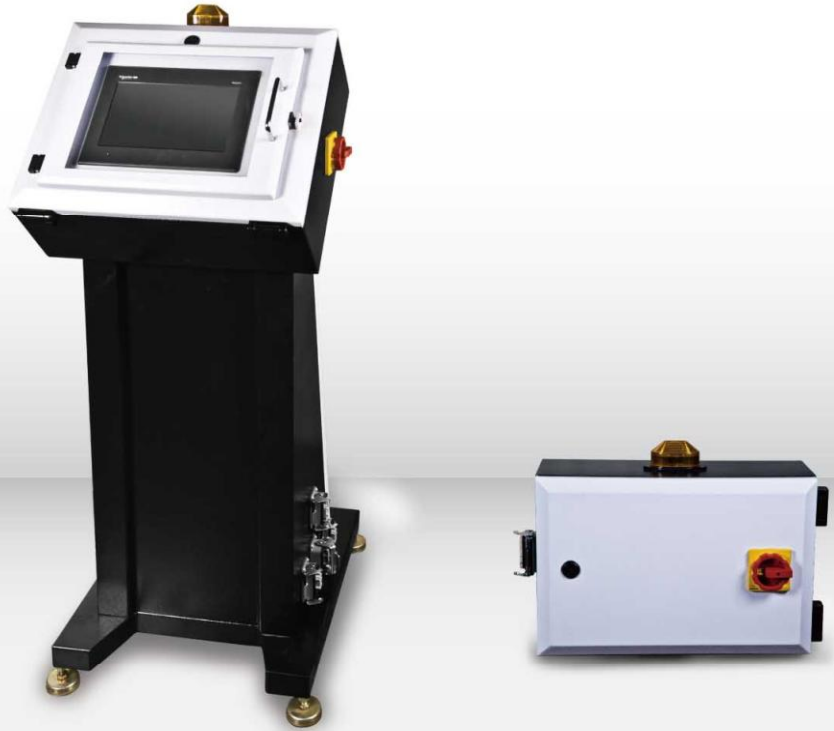

## Profibus Communication

SIEMENS S7-300PLC as main station, with profibus DP communication protocol, connected to each small networks or I/O in the workshop, then forms large-sized network and realizes multiple control including data transmission of dosing proportion and material handling. Also it can be connected to IPC to achieve centralized controlling of whole factory automation.

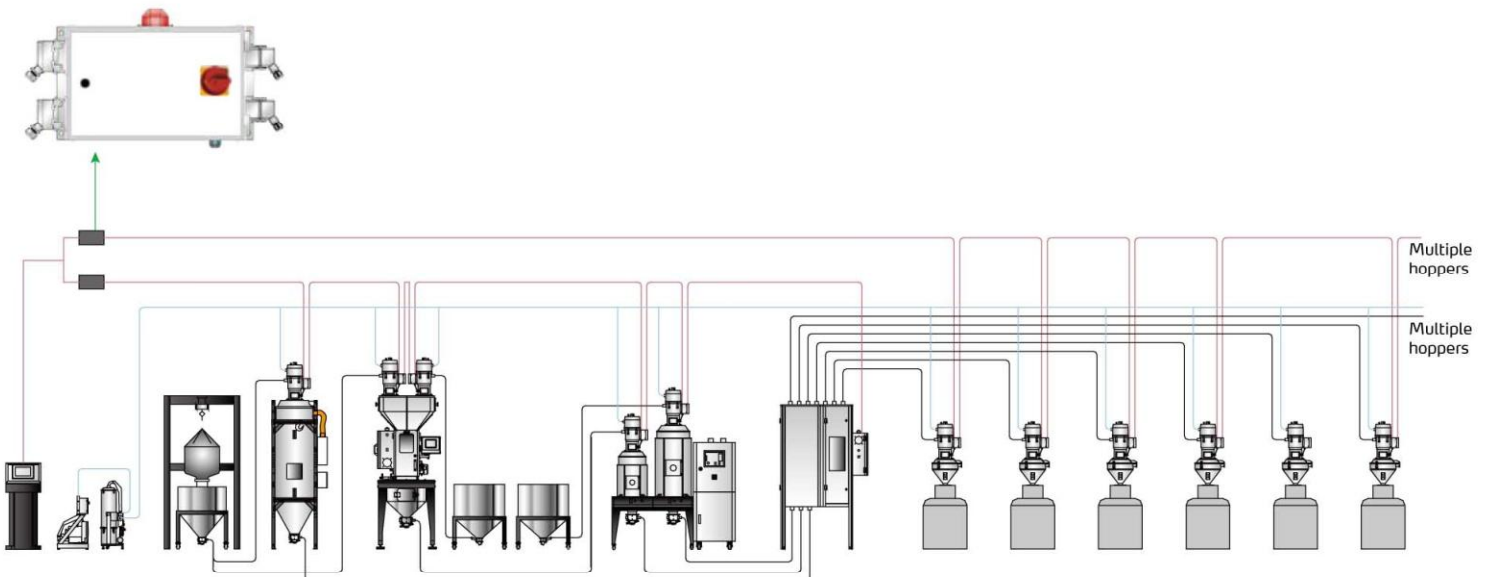

## Central Vacuum Generator

In central conveying system, central vacuum generator will provide vacuum (negative pressure) power. This machine adopts high pressure blower or Roots blower as its core power, which has features like heavy-duty, great power and long service life etc to ensure continuously loading. Besides, this series offer more than 11 models with maximum 15 HP applicable to different system applications. The start of the blower is controlled via central control station and can work with equipments like Euro vacuum central hopper and central filter to realize automatic material loading function.



## Dry Running Pump

Claw pumps and compressors generate contact-free vacuum or compressed air efficiently and economically. This is possible because of the principle of internal compression. The gas is pre-compressed within the compressing chamber and is then discharged. This leads to an evident energy saving compared to rotary lobe blower designs without internal compression.

- Dry, contact-free operation
- Process safe and reliable
- No oil in the compression chamber
- Frequency control available
- Low sound level
- No greasing of bearings

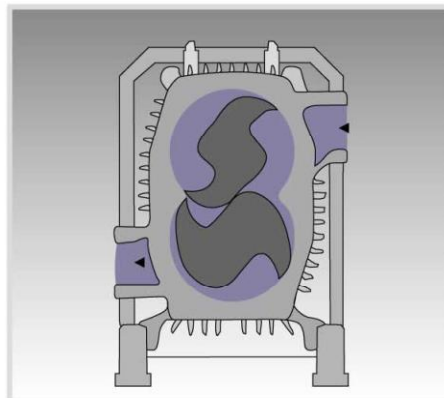

# Central Material Handling

## Mini Conveying System

Shini mini conveying system is suitable for conveying of virgin material. It is based on efficient Euro type design with stainless steel hopper that can ensure that, the material is free from any contamination. The user friendly touch panel is used to control the multi-functions of the system. This system can be used to convey different materials using Euro type vacuum hoppers in 1 to 12 stations located at a long distance.



- Down-blowing design with cyclone defender and dust collecting barrel inbuilt with the filter, helps to effectively reduce the load on the filter
- Separate hoppers with efficient Euro type design, made of stainless steel material ensure contamination free process
- Separate dust collecting barrel to make dust cleaning more convenient
- Host machine is equipped with failure and motor overload audio visual alarm that draw operators attention instantly after failure takes place
- All host machines are equipped with vacuum separating valves to protect blower
- Central control plate can centrally set material suction parameters of each station
- Adopt distributed bus-bar control method to use the least cables and make installation and maintenance much easier
- RS485 provided for data transfer and communication

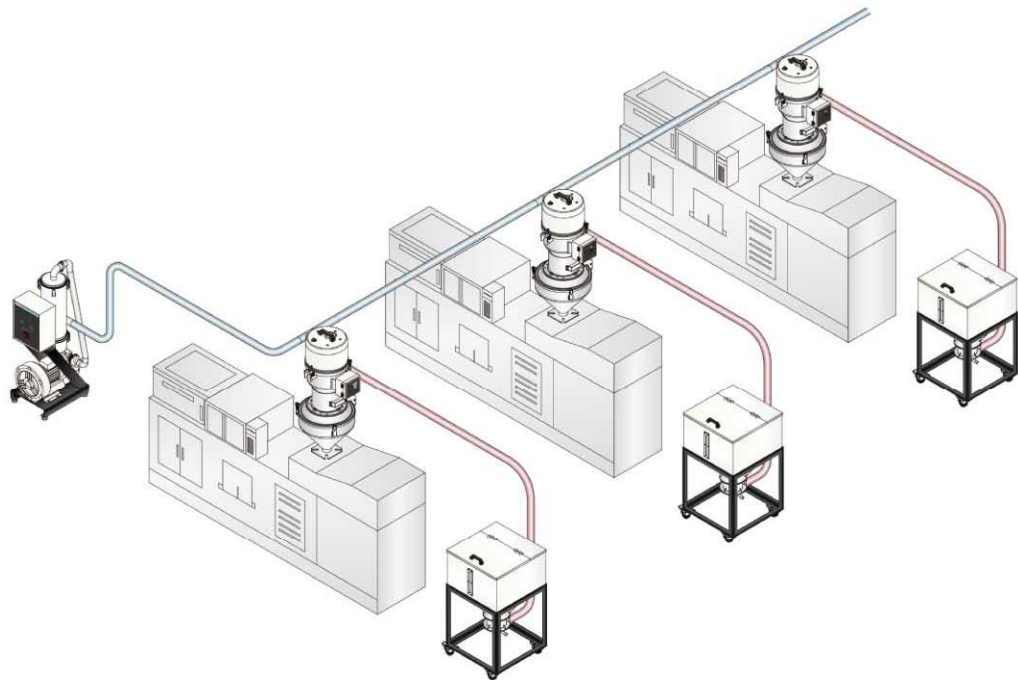

## Central Safety Filter

SCSF series central safety filter in central loading system adopts large dust collector to filter dust and small impurities in material so can effectively protect blower and prolong its service life. Self-cleaning function realize the effective cleaning of the filter by set-up auto timer, which can reduce manual clean times. Equipped with vacuum breaking valve to not only protect the blower, but also accelerate conveying and loading speed.



- European type design with compact structure, easy to operate.
- Inbuilt filter to effectively filter dust.
- Adopt air accumulator connected to compressed air to achieve self-cleaning.
- Pressure releasing valve to exhaust high pressure air when spraying and de-dusting to avoid dusts spraying in the air.
- Catch latch connecting collective bin to main unit make dust cleaning much easier.
- Air-inlet pipe and gas pipe adopts detachable quick coupler.
- Equipped with high pressure air regulator within filter.
- Shockproof floor stand ensures stable operation.
- Cloth bag filter can applied to application with regrinds or dust-rich materials.



Cloth Bag Filter

## Central Hopper Receiver

SHR-US series central hopper receivers are necessary equipments for material loading systems. There are 2 type of hopper: vacuum hopper and photosensor hopper. The vacuum hopper can be mounted directly on the dryer and controlled by magnetic switch to load materials; the photosensor hopper can be installed on molding machine and controlled by interactive photo - sensor to load materials. Both of them adopt CE standard plug and comply with Europe safety standard. A diaphragm valve is equipped inside, which can work with central vacuum generator and central control station to perform systematic feeding and conveying work.



SHR-U-S



SHR-U-ES

- A vacuum diaphragm valve is equipped inside.
- All hoppers can be auto-controlled by central controller.
- Material Inlet pipe adopt non-return valve to prevent material mixing during suction.
- Inside equipped with a stainless steel mesh filter to prevent materials being absorbed into vacuum line.
- All the hopper receivers are equipped with hinge covers, which ensures mesh filter cleaning conveniently.
- It is available to select 14-hole stainless steel mesh when regrind materials occupy over 30% of the total conveyed raw materials, to prolong hopper receiver's life circle.
- If several central hopper receivers should share the same material pipe, optional non-return valve or pneumatic non-return valve is available.

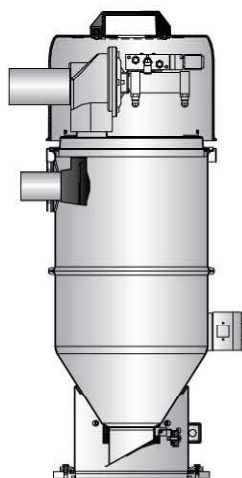

Airtight State

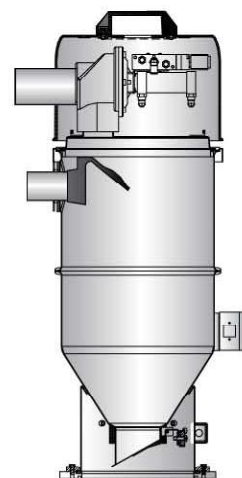

Material Suction State

## Material Distribution Station



### SMDS

- Material feeding pipe can be selected properly due to the use of quick coupler.
- System efficiency is improved by material depliers and auxiliary couplers.
- Firm, durable, and long service life.
- Changing material during operation is convenient and quick.
- Material deplier is made of stainless steel to eliminate material contamination.



### SMDS-AU

- At most 24 materials to 24 machines with 576 distribution methods can be satisfied.
- Each motion mechanism adopts stroke measurement switch to detect cylinder withdrawal and ensures safety.
- Controlled by central station, it is suitable for applications with large scale feeding systems.
- Motion mechanism can be reduced according to actual needs.
- 1.5" and 2" material pipes are optional.
- Multi-alarms indicating low pressure, cylinder withdrawal not in place and no action of cylinder are equipped to warn users.

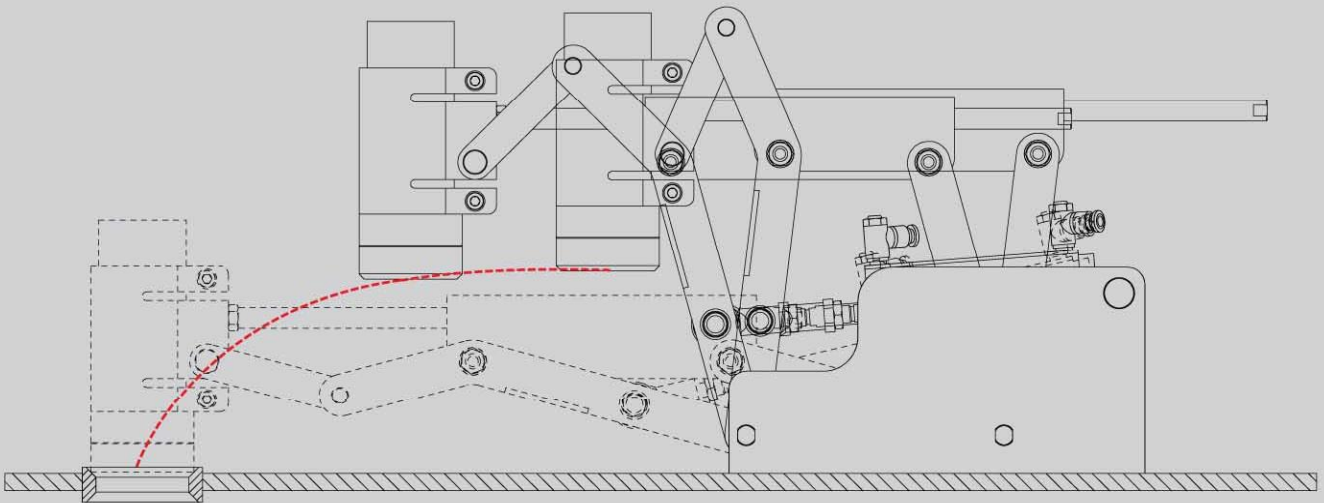

SMDS-AU Arm Link Dynamic Diagram

## Shini Group

Addr: No. 23, Minhe St., Shulin Dist.,  
New Taipei, Taiwan

Tel: +886 2 2680 9119

Fax: +886 2 2680 9229

Email: [shini@shini.com](mailto:shini@shini.com)

## Factories:

- Taiwan
- Dongguan
- Pinghu
- Ningbo
- Mumbai

2013-04-15-04 Copyrights Reserved.

[www.shini.com](http://www.shini.com)