

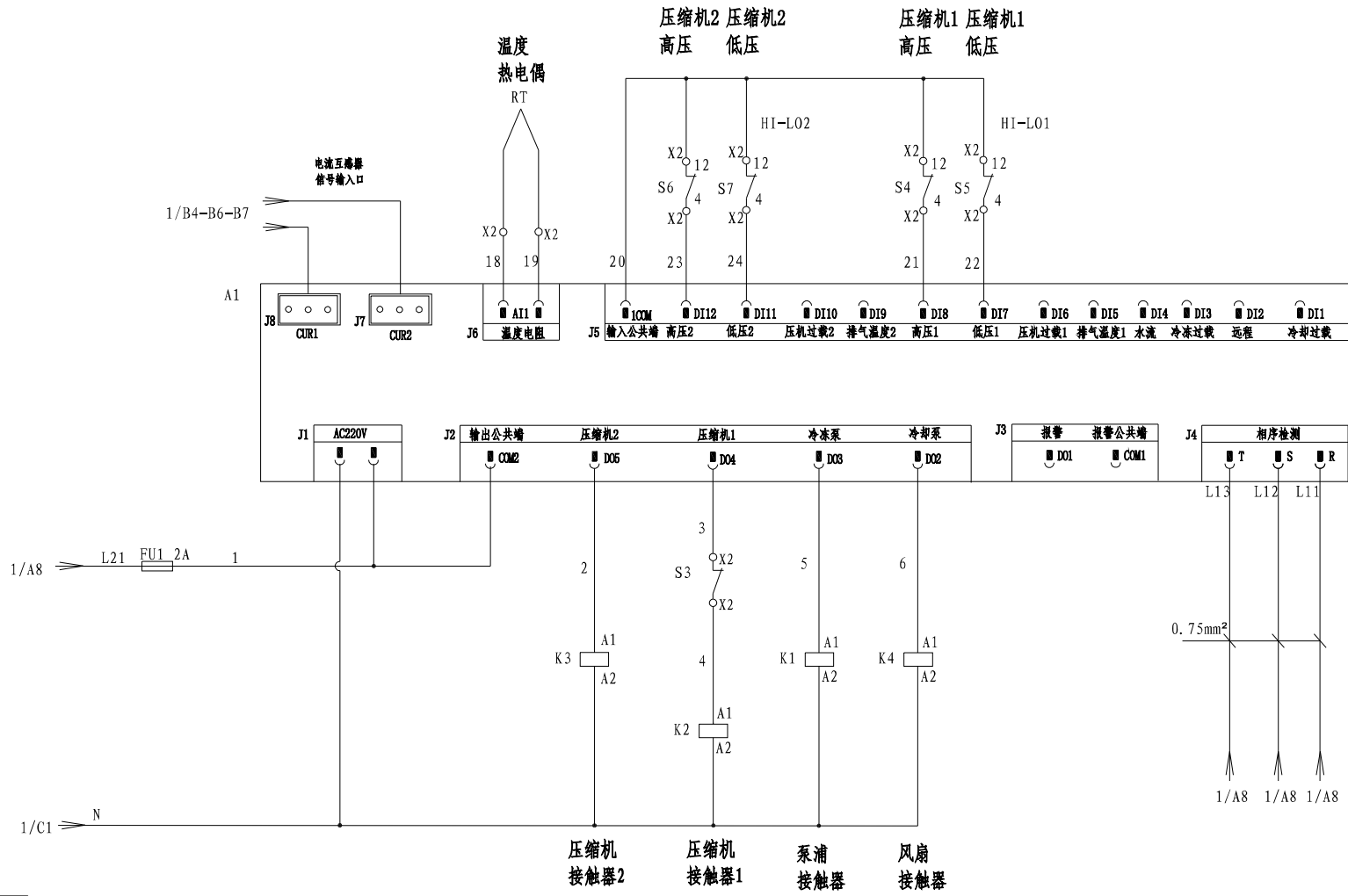



					制图	版号	0	标题	SIC-10A-EB 主电路图	图号	SIC-10A-EB-GB-0-1	比例	第 1 张
					设计	核						标准	GB
					校对	准						机器电压	3/N/PE/400V
标记	更改前	更改后	更改人	日期	审核	日期	20240830	 信易電熱機械股份有限公司 Shini Plastics Technologies, Inc.	机器频率	50Hz			

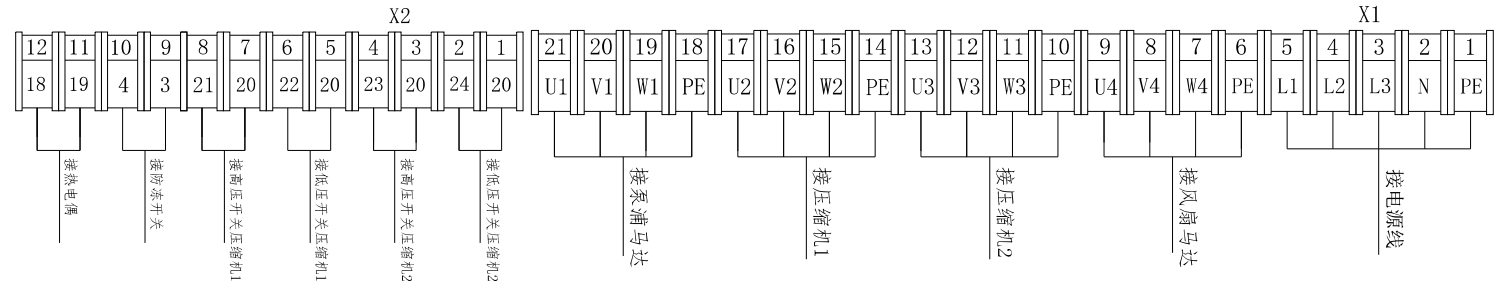
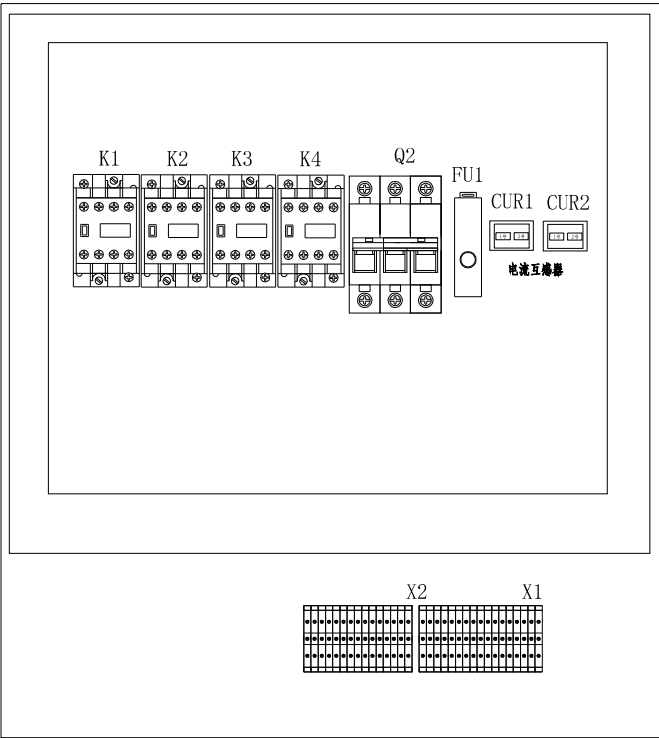
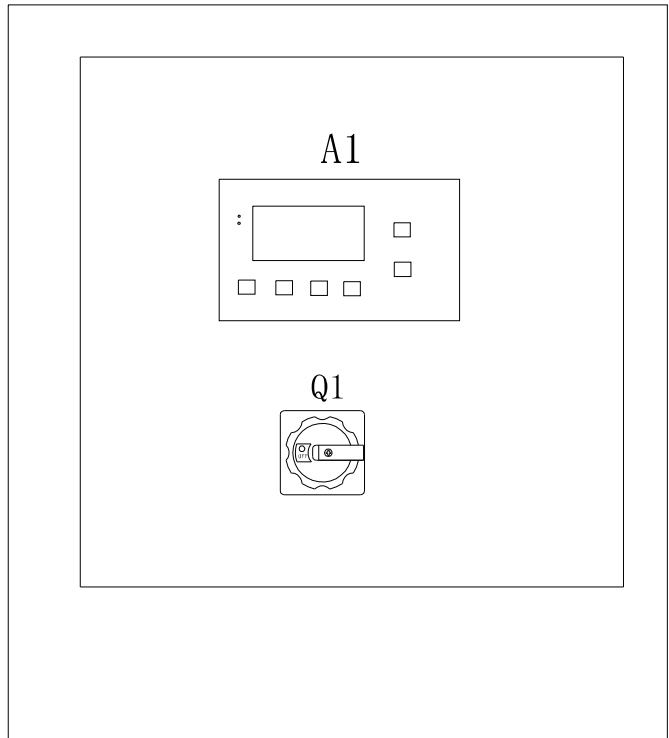

机型版本 Ver. A

					制图	版号	0	标题	SIC-10A-EB	图号	SIC-10A-EB-GB-0-2	比例	第 2 张	
					设计	核准		控制电路图				标准	GB	共 4 张
					校对			 信易电热机械股份有限公司 Shini Plastics Technologies, Inc.				机器电压	3/N/PE/400V	
标记	更改前	更改后	更改人	日期	审核	日期	20240830			机器频率	50Hz			



					制图	版号	0	标题	SIC-10A-EB	图号	SIC-10A-EB-GB-0-3	比例	第 4 张	
					设计	核 准		元件布置图				标准	GB	共 5 张
					校对								机器电压	3/N/PE/400V
标记	更改前	更改后	更改人	日期	审核	日期	20240830	 信易電熱機械股份有限公司 Shini Plastics Technologies, Inc.				机器频率	50Hz	

1 2 3 4 5 6 7 8

1		2		3		4		5		6		7		8	
序号/NO.	符号 /Symbol	名称 /Name		制造商 /Manufacturer		型号/Type		规格/Specification		数量/Number		物料编号/Material Number		备注/Remark	
1	Q1	主电源开关/Main switch		EATON		P1-25/EA/SVB		25A		1		YE10125250000			
2	Q2	断路器/Circuit breakers		TECO		BM-63C/30		20A		1		YE40302003000			
A	3	K1,K4		接触器/Contactors		SIEMENS		3RT6015-1AN21		230V 50/60Hz		1		YE00601521000	
	4	K2,K3		接触器/Contactors		SIEMENS		3RT6016-1AN22		230V 50/60Hz		2		YE00601622000	
	5	RT		温度传感器/sensitive line		CAREL		NTC025HP00		----		1		YE10250000000	
	6	A1		冰水机控制器/The controller		----		----		1		YE80532000100			
	7			面板		----		----		1		YR01532100100			
	8	TA1		双电路互感器		----		----		2		YE80122000600			
	9	FU1		熔断器/Fuse		CHINT		FS-10		2A		YE41001000000			
B	10	X1		端子排/Terminal		HONEYWELL		SK4MM ²		4mm ²		4		YE60000403200	
	11			端子排/Terminal		HONEYWELL		GK4MM ² PE		4mm ² PE		1		YE61041000000	
	12	X2		端子排/Terminal board		HONEYWELL		2.5mm ²		SK2.5		24		YE60002503200	
	13	PE		端子排/Terminal board		HONEYWELL		2.5mm ² PE		GK2.5 PE		4		YE60002503400	
	14	S3		防冻开关				ZA35-555-12A				1		YW85071100000	
	15	S4 S6		高压开关		LEFOO		LF08-3.0/4.0		250VAC/3A		2		YE10304000300	
	16	S5 S7		低压开关		LEFOO		LF08-1.2/0.2		250VAC/3A		2		YE10021200300	
	17			0.75×1C红色线		----		0.75mm ² *1C		M				YE50750100000	
	18			1.5×1C黑色线		----		1.5mm ² *1C		M				YE50015100000	
C	19			电线1.25×1C黄绿线		----		1.25mm ² *1C		M				YE50125140300	
	20			4.0×1C黑色线		----		4.0mm ² *1C		M				YE50040100000	
				电线4.0×1C黄绿线		----		4.0mm ² *1C		M				YE50040140100	
D						制图		版号		0		标题		SIC-10A-EB	
						设计		核				图号		SIC-10A-EB-GB-0-4	
						校对		准				比例		第 4 张	
						审核		日期		20240830		标准		GB 共 4 张	
	标记	更改前		更改后		更改人		日期				机器电压		3/N/PE/400V	
	1	2		3		4		5		6		7		8	
								SHINI		信易電熱機械股份有限公司 Shini Plastics Technologies, Inc.		机器频率		50Hz	

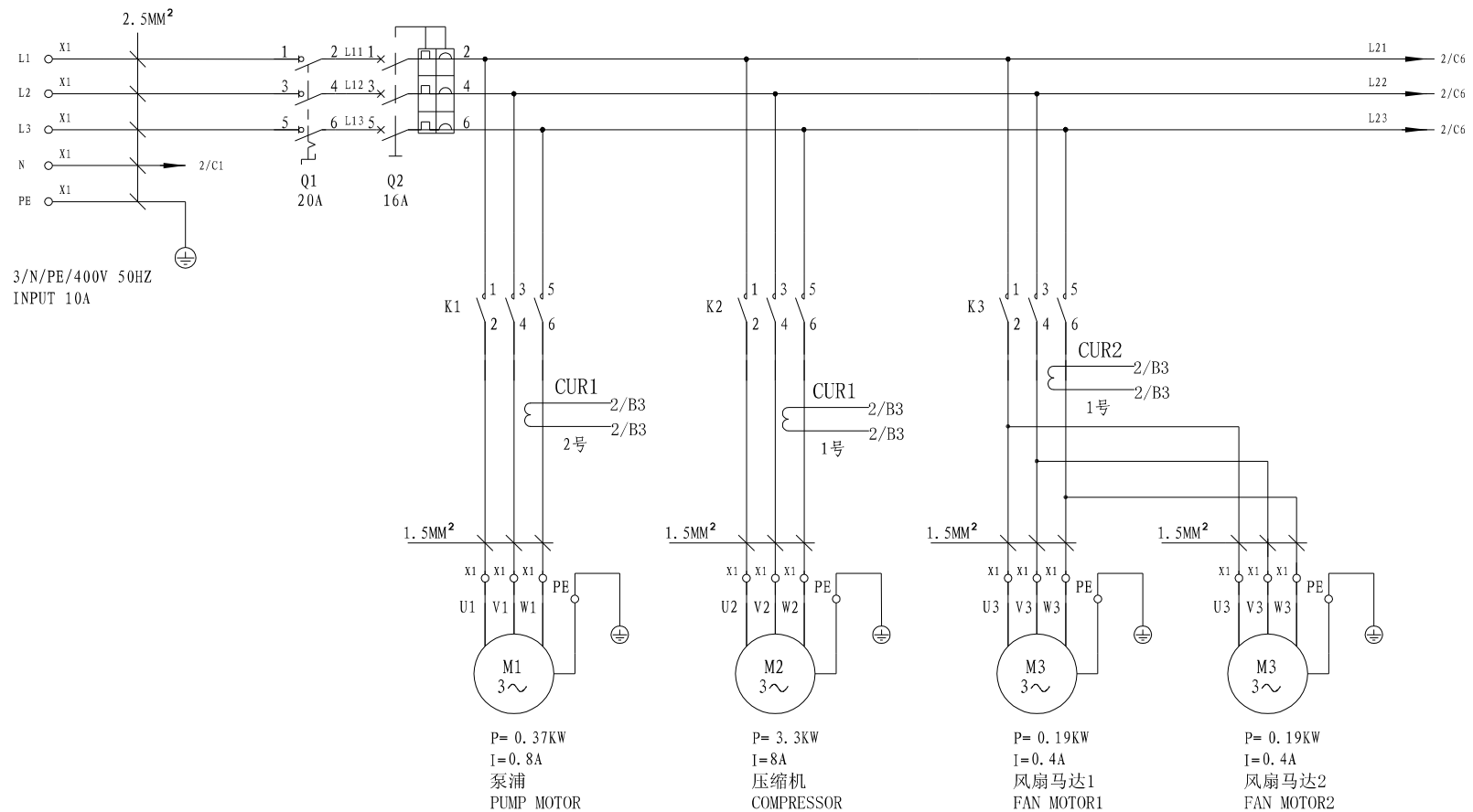

					制图	版号	0	标题	SIC-5A-EB	图号	SIC-5A-EB-GB-0-1	比例	第 1 张
					设计	核		主电路图				标准	共 4 张
					校对	准		 信易電熱機械股份有限公司 Shini Plastics Technologies, Inc.	机器电压	3/N/PE/400V			
标记	更改前	更改后	更改人	日期	审核	日期	20240830		机器频率	50Hz			

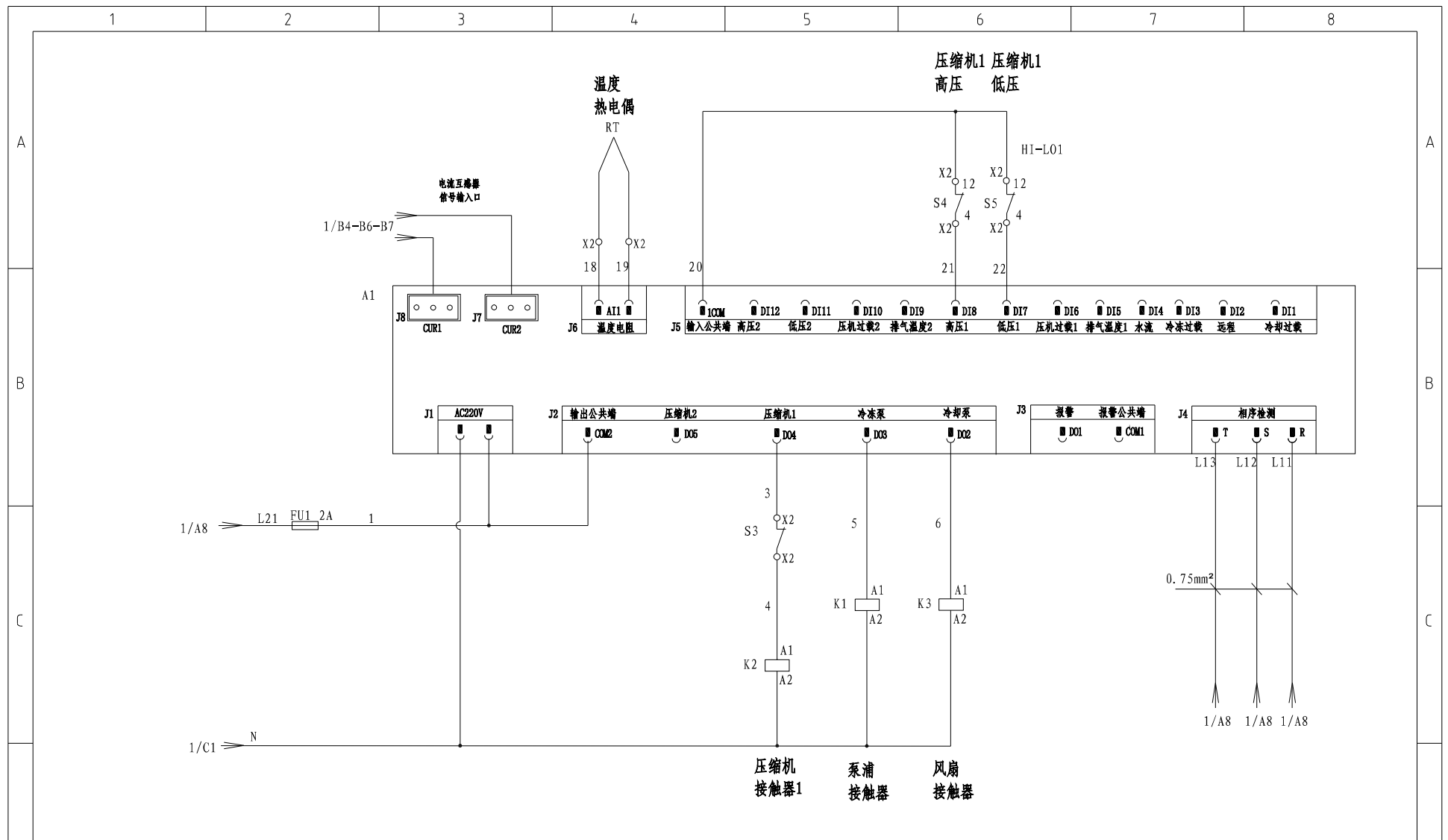

					制图	版号	0	标题	SIC-5A-EB	图号	SIC-5A-EB-GB-0-2	比例	第 2 张
					设计	核 准		控制电路图				标准	GB 共 4 张
					校对			 信易电热机械股份有限公司 Shini Plastics Technologies, Inc.				机器电压	3/N/PE/400V
标记	更改前	更改后	更改人	日期	审核	日期	20240830			机器频率	50Hz		
1	2	3	4	5	6	7	8						

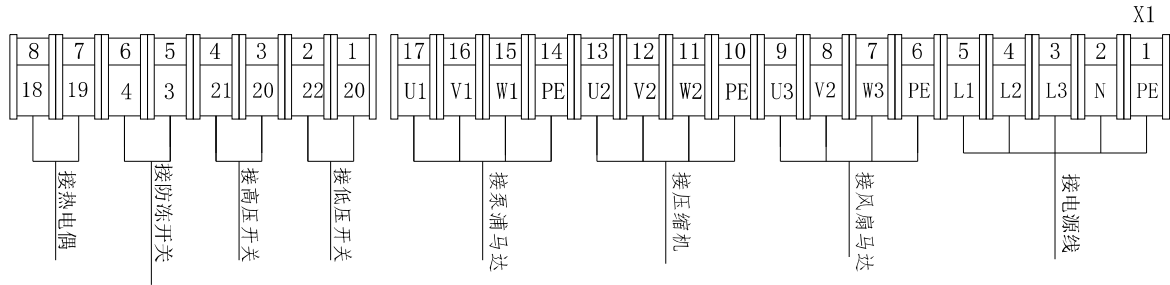
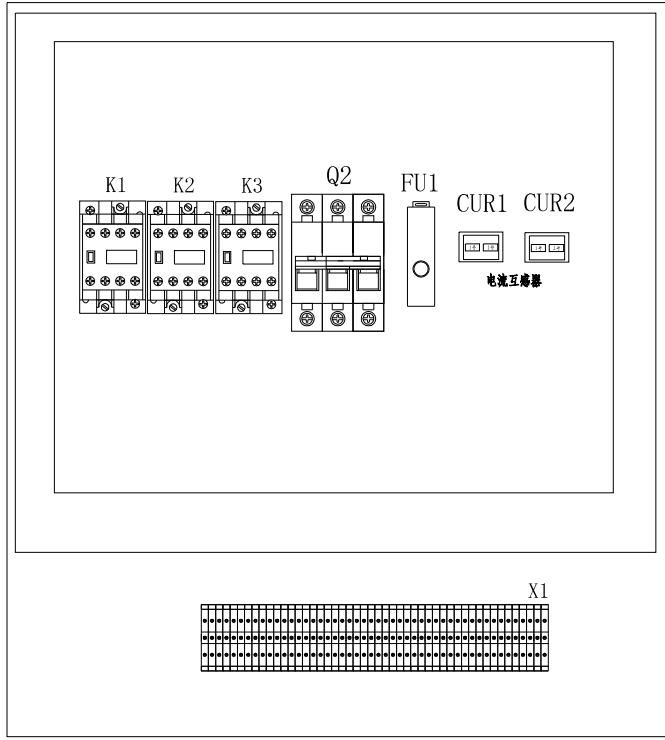
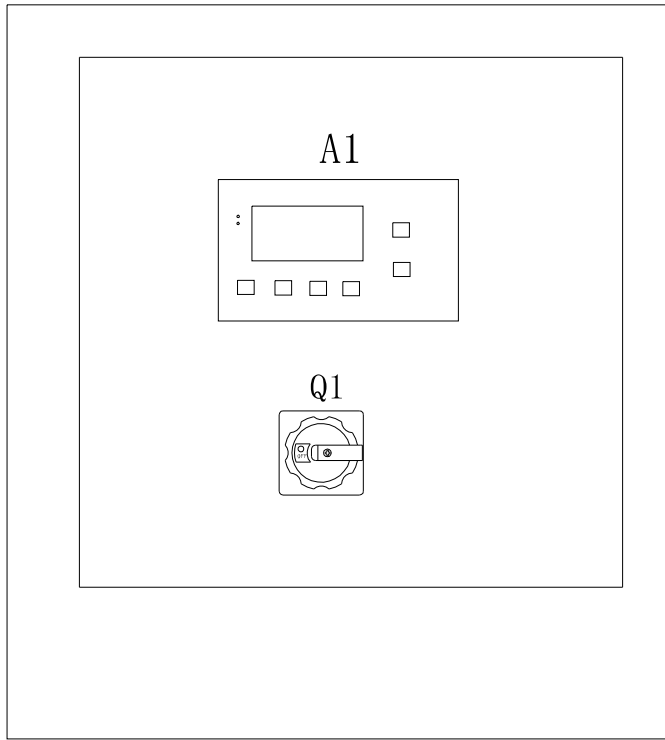

					制图	版号	0	标题	SIC-5A-EB	图号	SIC-5A-EB-GB-0-3	比例	第 3 张
					设计	核准		元件布置图				标准	GB 共 4 张
					校对			 信易電熱機械股份有限公司 Shini Plastics Technologies, Inc.	机器电压		3/N/PE/400V		
标记	更改前	更改后	更改人	日期	审核	日期	20240830		机器频率		50Hz		

1	2	3	4	5	6	7	8	
序号/NO.	符号/Symbol	名称/Name	制造商/Manufacturer	型号/Type	规格/Specification	数量/Number	物料编号/Material Number	备注/Remark
A 1	Q1	主电源开关/Main switch	EATON	T0-2-1/EA/SVB	20A	1	YE10021160000	
2	Q2	断路器/Circuit breakers	TECO	BM-63C/30	16A	1	YE40301003000	
3	K1	接触器/Contactors	SIEMENS	3RT6015-1AN21	230V 50/60Hz	1	YE00601521000	
4	K2	接触器/Contactors	SIEMENS	3RT6016-1AN21	230V 50/60Hz	1	YE00601621000	
5	K3	接触器/Contactors	SIEMENS	3RT6015-1AN21	230V 50/60Hz	1	YE00601521000	
6	RT	温度传感器/sensitive line	CAREL	NTC025HP00	----	1	YE10250000000	
7	A1	冰水机控制器/The controller	----	----	----	1	YE80532000100	
8		面板	----	----	----	1	YR01532100100	
9	TA1	双电路互感器	----	----	----	2	YE80122000600	
B 10	FU1	熔断器/Fuse	CHINT	FS-10	2A	1	YE41001000000	
11	X1	端子排/Terminal board	HONEYWELL	2.5mm ²	SK2.5	21	YE60002503200	
12	PE	端子排/Terminal board	HONEYWELL	2.5mm ² PE	GK2.5 PE	4	YE60002503400	
13	S3	防冻开关		ZA35-555-12A		1	YW85071100000	
14	S4 S6	高压开关	LEFOO	LF08-3.0/4.0	250VAC/3A	2	YE10304000300	
15	S5 S7	低压开关	LEFOO	LF08-1.2/0.2	250VAC/3A	2	YE10021200300	
16		0.75×1C红色线	----	0.75mm ² *1C	M		YE50750100000	
17		1.5×1C黑色线	----	1.5mm ² *1C	M		YE50015100000	
18		电线1.25×1C黄绿线	----	1.25mm ² *1C	M		YE50125140300	
C 19		2.5×1C黑色线	----	2.5mm ² *1C	M		YE50250100200	
20		电线2.5×1C黄绿线	----	2.5mm ² *1C	M		YE50250100600	
D								
				制图	版号	0	标题	SIC-5A-EB
				设计	核		图号	SIC-5A-EB-GB-0-4
				校对	准		比例	第 4 张
				审核	日期	20240830	标准	GB 共 4 张
标记	更改前	更改后	更改人	日期	20240830		SHINI 信易電熱機械股份有限公司 Shini Plastics Technologies, Inc.	机器电压 3/N/PE/400V
							机器频率	50Hz
1	2	3	4	5	6	7	8	

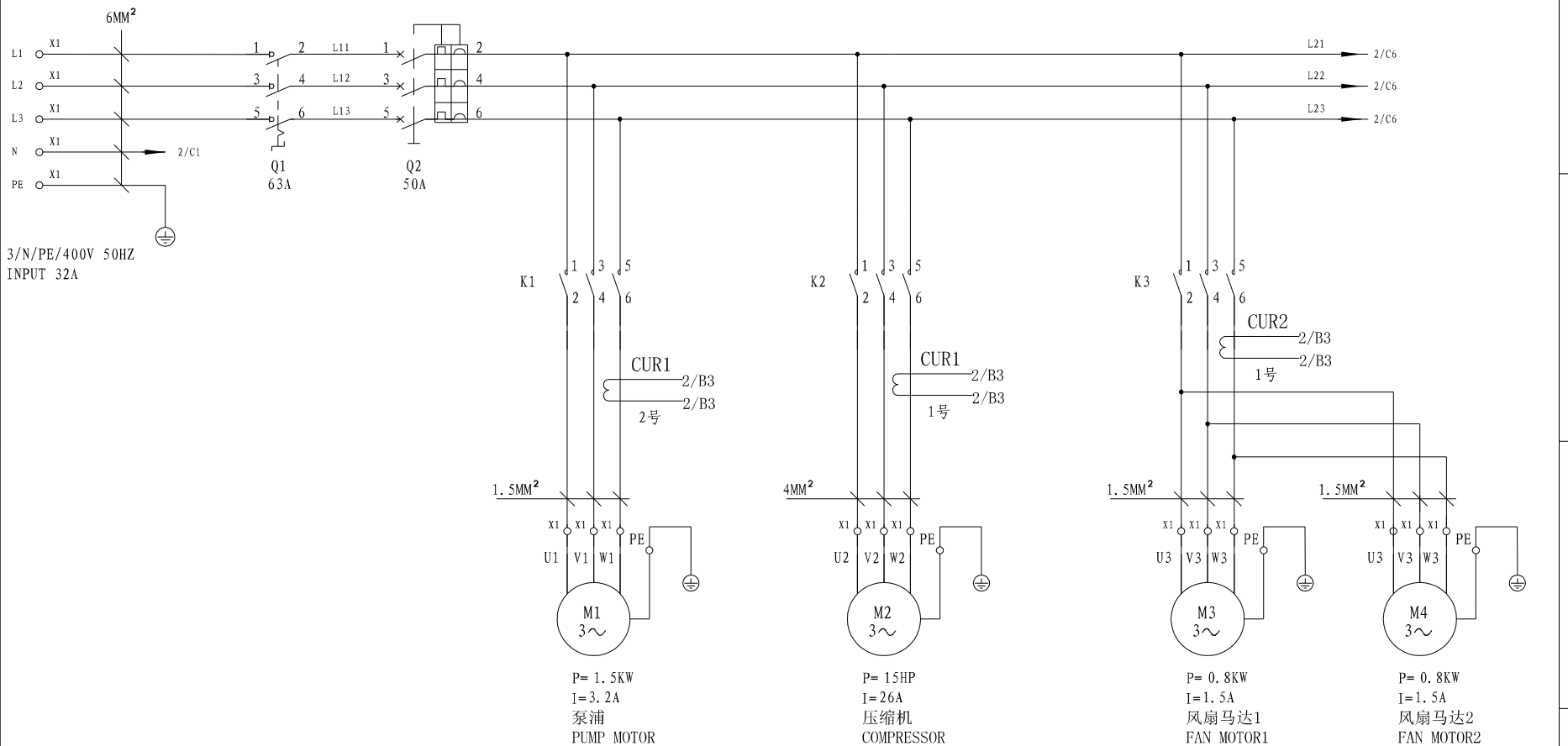

					制图	版号	0	标题	SIC-15A-EB 主电路	图号	SIC-15A-EB-GB-0-1	比例	第 1 张	
					设计	核准		图	SHINI 信易電熱機械股份有限公司 Shini Plastics Technologies, Inc.			标准	GB	共 4 张
					校对	日期	20240830			机器电压	3/N/PE/400V		机器频率	50Hz
标记	更改前	更改后	更改人	日期	审核	日期	20240830							

1 2 3 4 5 6 7 8

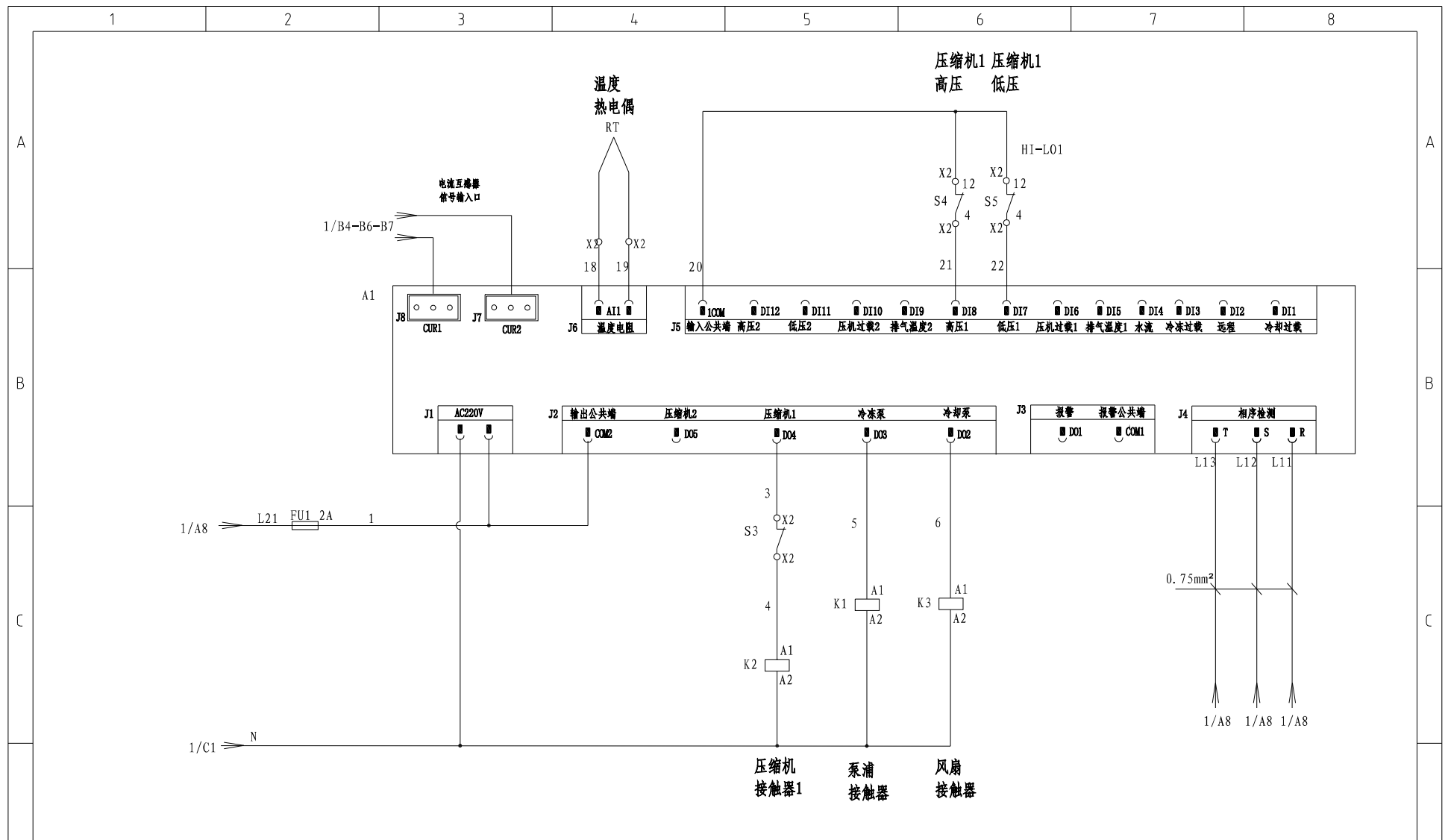

					制图	版号	0	标题	SIC-15A-EB	图号	SIC-15A-EB-GB-0-2	比例	第 2 张	
					设计	核		控制电路图				标准	GB	共 4 张
					校对	准		 信易电热机械股份有限公司 Shini Plastics Technologies, Inc.				机器电压	3/N/PE/400V	
标记	更改前	更改后	更改人	日期	审核	日期	20240830			机器频率	50Hz			

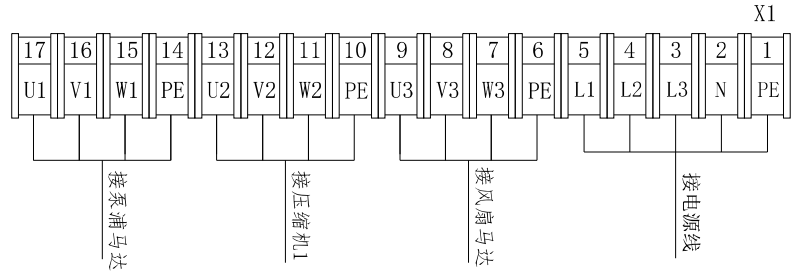
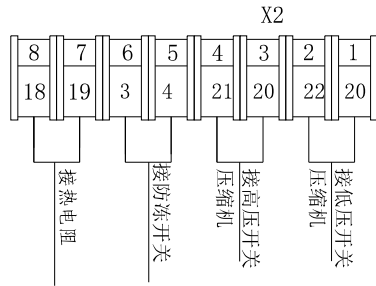
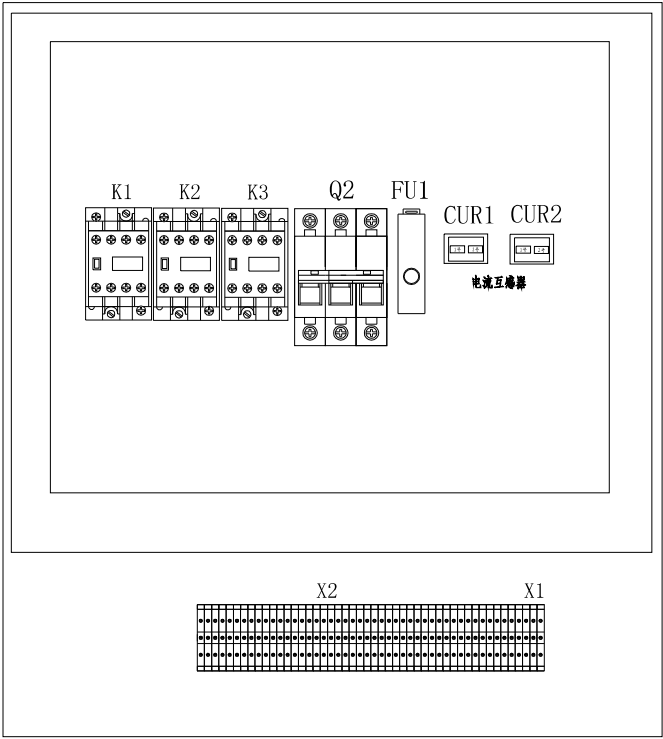
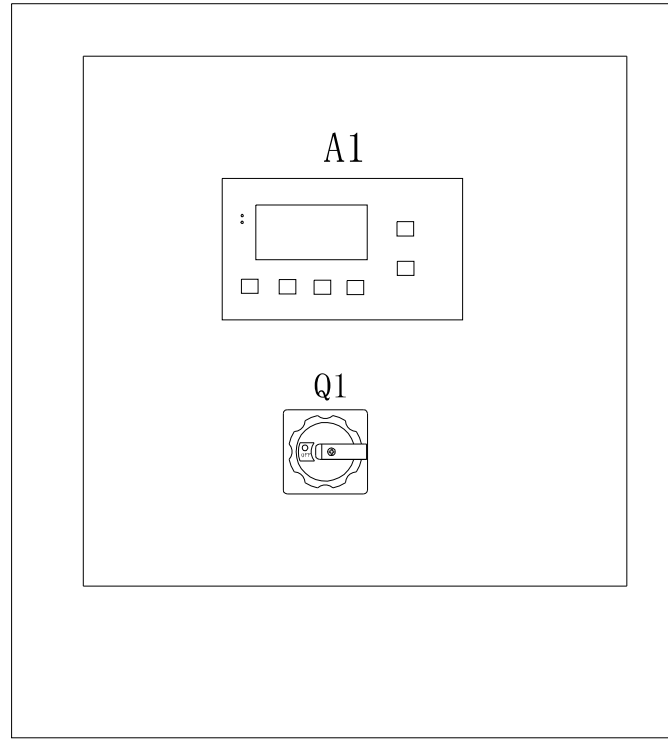

					制图	版号	0	标题	SIC-15A-EB 元件布置图	图号	SIC-15A-EB-GB-0-3	比例	第 3 张
					设计	核						标准	GB 共 4 张
					校对	准						机器电压	3/N/PE/400V
标记	更改前	更改后	更改人	日期	审核	日期	20240830	信易電熱機械股份有限公司 Shini Plastics Technologies, Inc.	机器频率	50Hz			

1 2 3 4 5 6 7 8

1		2		3		4		5		6		7		8																																																																			
序号/NO.	符号/Symbol	名称/Name		制造商/Manufacturer		型号/Type		规格/Specification		数量/Number	物料编号/Material Number		备注/Remark																																																																				
1	Q1	主电源开关/Main switch		EATON		P3-63/EA/SVB		63A		1	YE10636300000																																																																						
2	Q2	断路器/Circuit breakers		TECO		BM-63C/3050S		50A		1	YE40305003000																																																																						
3	K1 K3	接触器/Contactors		SIEMENS		3RT6015-1AN21		230V 50/60Hz		2	YE00601521000																																																																						
4	K2	接触器/Contactors		SIEMENS		3RT6027-1AN20		230V 50/60Hz		1	YE00602722000																																																																						
5	RT	温度传感器/sensitive line		CAREL		NTC025HP00		----		1	YE10250000000																																																																						
6	A1	冰水机控制器/The controller		----		----		----		1	YE80532000100																																																																						
7		面板		----		----		----		1	YR01532100100																																																																						
8	TA1	双电路互感器		----		----		----		2	YE80122000600																																																																						
9	FU1	熔断器/Fuse		CHINT		FS-10		2A		1	YE41001000000																																																																						
10	X1	端子排/Terminal board				6mm ²		GK6.0		4	YE60000603200																																																																						
11		端子排/Terminal board				6mm ² PE		GK6.0 PE		1	YE60000603500																																																																						
12		端子排/Terminal		HONEYWELL		SK4MM ²		4mm ²		4	YE60000403200																																																																						
13		端子排/Terminal		HONEYWELL		GK4MM ² PE		4mm ² PE		1	YE61041000000																																																																						
14	X2	端子排/Terminal board		HONEYWELL		2.5mm ²		SK2.5		14	YE60002503200																																																																						
15	PE	端子排/Terminal board		HONEYWELL		2.5mm ² PE		GK2.5 PE		2	YE60002503400																																																																						
16	S3	防冻开关				ZA35-555-12A				1	YW85071100000																																																																						
17	S4 S6	高压开关		LEFOO		LF08-3.0/4.0		250VAC/3A		2	YE10304000300																																																																						
18	S5 S7	低压开关		LEFOO		LF08-1.2/0.2		250VAC/3A		2	YE10021200300																																																																						
19		0.75×1C红色线		----		0.75mm ² *1C		M			YE50750100000																																																																						
20		1.5×1C黑色线		----		1.5mm ² *1C		M			YE50015100000																																																																						
21		电线1.25×1C黄绿线		----		1.25mm ² *1C		M			YE50125140300																																																																						
		4.0×1C黑色线		----		4.0mm ² *1C		M			YE50040100000																																																																						
		电线4.0×1C黄绿线		----		4.0mm ² *1C		M			YE50040140100																																																																						
		6.0×1C黑色线		----		6.0mm ² *1C		M			YE50060140200																																																																						
		电线6.0×1C黄绿线		----		6.0mm ² *1C		M			YE50601000300																																																																						
<table border="1" style="width: 100%; border-collapse: collapse;"> <tr> <td colspan="2"></td> <td colspan="2"></td> <td colspan="2">制图</td> <td colspan="2">版号</td> <td colspan="2">0</td> <td colspan="2">标题</td> <td colspan="2">图号</td> <td colspan="2">比例</td> </tr> <tr> <td colspan="2"></td> <td colspan="2"></td> <td colspan="2">设计</td> <td colspan="2">核</td> <td colspan="2"></td> <td colspan="2" rowspan="2" style="text-align: center;"> 信易電熱機械股份有限公司 Shini Plastics Technologies, Inc. </td> <td colspan="2" rowspan="2" style="text-align: center;"> SIC-15A-EB-GB-0-4 元件清单 </td> <td colspan="2">第 4 张</td> </tr> <tr> <td colspan="2"></td> <td colspan="2"></td> <td colspan="2">校对</td> <td colspan="2">准</td> <td colspan="2"></td> <td colspan="2">标准</td> <td colspan="2">GB</td> <td colspan="2">共 4 张</td> </tr> <tr> <td colspan="2">标记</td> <td colspan="2">更改前</td> <td colspan="2">更改后</td> <td colspan="2">更改人</td> <td colspan="2">日期</td> <td colspan="2">审核</td> <td colspan="2">日期</td> <td colspan="2">20240830</td> <td colspan="2"> 机器电压 3/N/PE/400V 机器频率 50Hz </td> </tr> </table>																				制图		版号		0		标题		图号		比例						设计		核				信易電熱機械股份有限公司 Shini Plastics Technologies, Inc.		SIC-15A-EB-GB-0-4 元件清单		第 4 张						校对		准				标准		GB		共 4 张		标记		更改前		更改后		更改人		日期		审核		日期		20240830		机器电压 3/N/PE/400V 机器频率 50Hz	
				制图		版号		0		标题		图号		比例																																																																			
				设计		核				信易電熱機械股份有限公司 Shini Plastics Technologies, Inc.		SIC-15A-EB-GB-0-4 元件清单		第 4 张																																																																			
				校对		准								标准		GB		共 4 张																																																															
标记		更改前		更改后		更改人		日期		审核		日期		20240830		机器电压 3/N/PE/400V 机器频率 50Hz																																																																	
1		2		3		4		5		6		7		8																																																																			