

# **SCM**

## **Volumetric Dosers**

Date: Aug. 2023

Version: Ver.I (English)





## Contents

<b>1. General Description .....</b>	<b>6</b>
1.1 Coding Principle.....	7
1.2 Features.....	7
1.3 Accessory Option.....	7
1.3.1 Dimensions of Doser .....	9
1.3.2 Specification List.....	9
1.4 Safety Regulations.....	10
1.4.1 Safety Signs and Labels.....	10
1.5 Exemption Clause.....	11
<b>2. Structure Characteristics and Working Principle.....</b>	<b>12</b>
2.1 Working Principle.....	12
2.2 Optional Accessories .....	13
2.2.1 Mixer.....	13
2.2.2 Main Hopper.....	13
2.2.1 Heavy base .....	14
2.2.2 Large Drying Hopper .....	14
<b>3. Installation and Debugging .....</b>	<b>15</b>
3.1 Install on Extrusion or Injection Molding Machine .....	15
3.2 Power Connection.....	15
3.3 Control Box Rear Button and Wiring.....	16
<b>4. Application and Operation.....</b>	<b>17</b>
4.1 Operation Instruction.....	17
4.1.1 Monitoring page.....	17
4.1.2 Machine Setting Screen .....	17
4.1.3 Parameter Setting.....	17
4.1.4 50S Output Test Steps .....	20
4.1.5 Recipe Setting.....	22
4.1.6 Run/Stop .....	23
4.2 Other Parameters Function.....	23

4.2.1 Password management.....	23
4.2.2 System Setting .....	24
4.3 Material Replacement.....	25
<b>5. Troubleshooting .....</b>	<b>27</b>
<b>6. Maintenance and Repair .....</b>	<b>28</b>
6.1 Repair .....	28
6.2 Maintenance .....	28
6.3 Maintenance Schedule .....	28
6.3.1 About the Machine.....	28
6.3.2 Check after Installation .....	28
6.3.3 Daily Checking .....	28
6.3.4 Weekly Checking.....	28

### Table Index

Table 1-1: Specification List of SCM.....	9
Table 2-1: Specification .....	13
Table 2-2: Specification .....	14
Table 2-3: Specification .....	14
Table 2-4: Specification .....	14
Table 3-1: Specification .....	16

### Picture Index

Picture 1-1: Single Color Doser SCM.....	6
Picture 1-2: Color Doser SCM-D.....	6
Picture 1-3: High-temp. Doser SCM-H.....	6
Picture 1-4: Dimensions of Doser .....	9
Picture 2-1: SCM Working Principle.....	12
Picture 3-1: Installation of Single Color Doser .....	15
Picture 3-2: Installation of Double-color Doser.....	15

Picture 3-3: Control Box Rear Button and Wiring.....	16
Picture 4-1: IMM Mode Monitoring Page.....	17
Picture 4-2: Machine Setting Screen.....	17
Picture 4-3: Parameter Setting Screen .....	18
Picture 4-4: High and Low Elec. Level / Decimal Selection Screen .....	19
Picture 4-5: Running Speed / Alarm Shutdown Selection Screen.....	20
Picture 4-6: Manual Operation Screen.....	21
Picture 4-7: 50 Secs. Output Test Screen.....	21
Picture 4-8 Fixed Base Taking-out Diagram .....	21
Picture 4-9: Recipe Setting Screen.....	22
Picture 4-10: Recipe Editing Screen .....	23
Picture 4-11: Run/Stop Screen .....	23
Picture 4-12: Password Log-in Screen.....	24
Picture 4-13: Password Modification Screen .....	24
Picture 4-14: Time Setting Screen .....	24
Picture 4-15: Comm. Address Setting Screen .....	25
Picture 4-16: Language Setting Screen .....	25
Picture 4-17: Data Download Screen.....	25
Picture 4-18: Material Replacement.....	26

# 1. General Description



Please read this manual carefully before installation and using of the machine to prevent damage or personal injuries.

SCM series volumetric Dosers are suitable for injection molding, extrusion blow molding and other occasions, and can be used for auto-proportional mixing of virgin materials, regrinds, master batch or additives. The injection molding machine supports various external signal input modes. Besides, double-color Doser is available for collocating with multiple color Dosers if required. Due to small additives proportion and dosage, SCM can work with the Venturi Loader VL to realize auto feeding of the master batch.

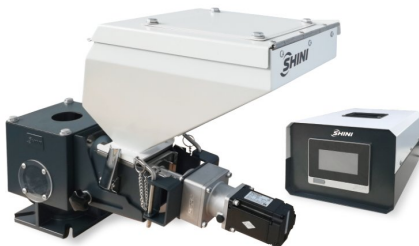

Picture 1-1: Single Color Doser SCM



Picture 1-2: Color Doser SCM-D



Picture 1-3: High-temp. Doser SCM-H

## 1.1 Coding Principle

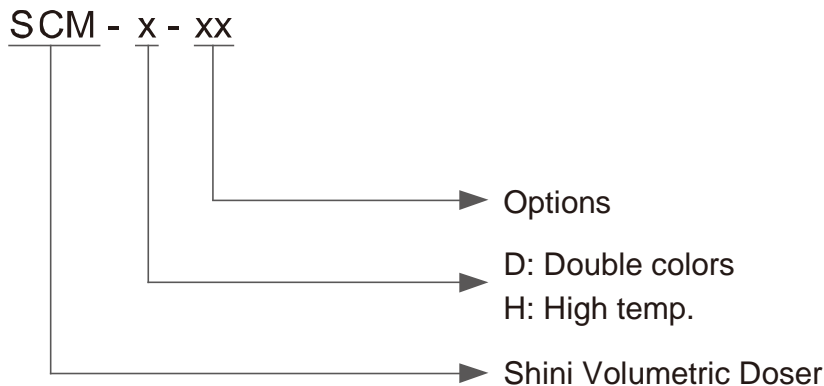

## 1.2 Features

- I Adopt high precision servo motor to ensure fast and smooth dosing.
- I Equipped with 1:5 gear box to increase the torque and reduce overload.
- I The throughput with a range of 0.1~130kg/h per screw.
- I Easy and user-friendly touch screen control.
- I Chrome coating dosing screw for longer durability.
- I Modular design for easy color change and maintenance.
- I Synchronize of masterbatch dosing ratio with extruder speed in the extrusion mode.
- I Uninterrupted production recovery in case of power failure.
- I Materials purge cleaning for easy replacement of master-batch.
- I Up to 50 memory slots for material receipts
- I Ability to monitor, alarm, and stop the unit during the masterbatch blockage via overload.
- I Support micro-dosing mode; masterbatch will dose once per X cycle.
- I The high temp. volumetric Doser with water cooling tank can process materials reaching 180°C drying temp.
- I Modbus RTU data communication via RS485.

## 1.3 Accessory Option

- I Optional masterbatch low-level sensor. Add “LS” at the end of the model code.

All service work should be carried out by a person with technical training or corresponding professional experience. The manual contains instructions for both handling and servicing. Chapter 6, which contains service instructions intended for service engineers. Other chapters contain instructions for the daily operator.

Any modifications of the machine must be approved by SHINI in order to avoid personal injury and damage to machine. We shall not be liable for any damage caused by unauthorized change of the machine.

Our company provides excellent after-sales service. Should you have any problem during using the machine, please contact the company or the local vendor.

Shini Hotline Service:

Headquarter and Taipei factory:

Tel: + 886 (0)2 2680 9119

Shini Plastics Technologies (Dongguan), Inc.:

Tel: +86 (0)769 8331 3588

Shini Plastics Technologies (Pinghu), Inc.:

Tel: +86 (0)573 8522 5288

Shinden Precision Machinery (Chongqing), Inc.:

+86 (0)23 6431 0898



## 1.3 Machine Specifications

### 1.3.1 Dimensions of Doser

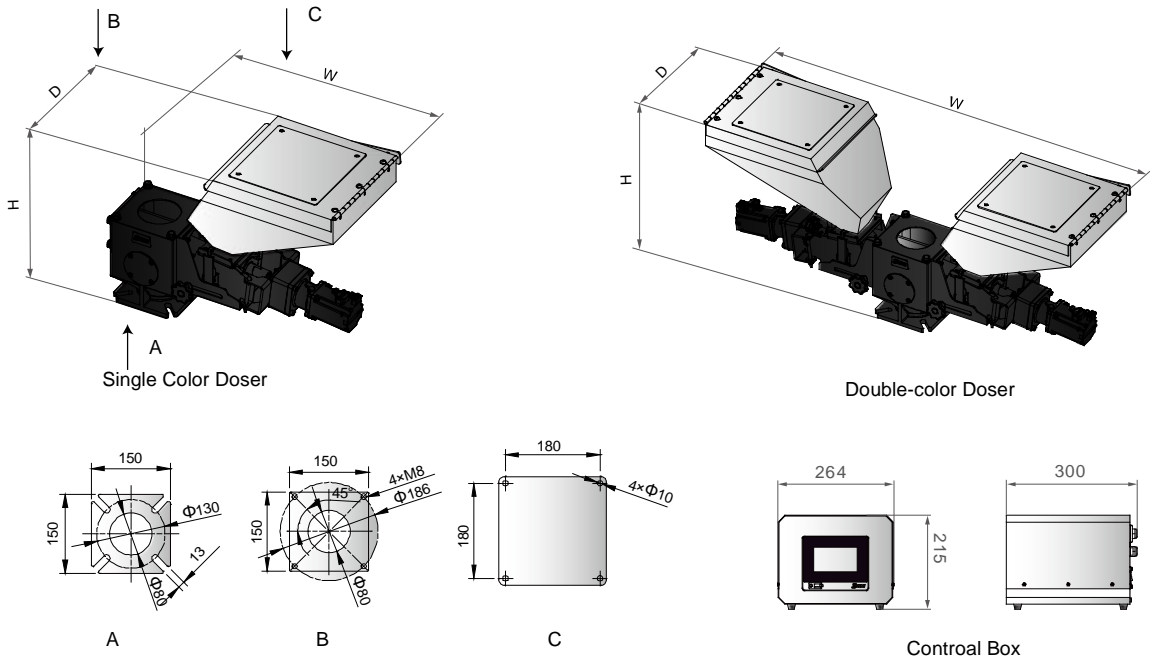

Picture 1-4: Dimensions of Doser

### 1.3.2 Specification List

Table 1-1: Specification List of SCM

Model	Single Color Unit		Double Color Unit	
	SCM/SCM-H		SCM-D	
Motor Power(kW)	0.4		0.4×2	
Screw External Dia. (mm)	16		16	
Output Capacity(kg/hr)	0.1~130		0.2~260	
Storage Hopper(L)	10		10	
External Dimensions	H(mm)	420	420	
	W(mm)	585	1030	
	D(mm)	300	300	
Weight(kg)	18		30	

We reserve the right to change specifications without prior notice.

#### Notes:

- 1) All output capacities of above models are base on data from bulk density 1.0kg/L, dia. 2~3mm masterbatch in test criteria of continuous running; The actual output capacity depends on the material properties , such as bulk density, mobility, particle size, etc., which also on the set formula.

2) Machine power: 1 $\Phi$ , 230VAC, 50Hz

3) When the master batch hopper is mounted with the auto conveying device, the total weight of the hopper shall not exceed 25KG (including the master batch).

## 1.4 Safety Regulations

Strictly abide by the following safety guide to prevent damage of the machine or personal injuries.

Do observe following safety rules when operating this machine.

### 1.4.1 Safety Signs and Labels



All the electrical components should be installed by qualified electricians.  
Turn off the main switch and control switch during maintenance or repair.



Warning!

High voltage!

This sign is attached on the cover of control box!



Warning!

Be careful!

Be more careful at the place where this sign appears!



Attention !

All the screws for installing electrical components in the control box are locked, which is no need of regular inspection!



Attention !

The cooling water of the SCM-H must be normal temperature water.



Warning!

Watch your hand!

The label sticks to the housing of the hopper!



Warning!

Be careful of scratch!

The label sticks to the coupling place of the screw and the metering motor!

## 1.5 Exemption Clause

The following statements clarify the responsibilities and regulations born by any buyer or user who purchases products and accessories from Shini (including employees and agents).

Shini is exempted from liability for any costs, fees, claims and losses caused by reasons below:

1. Any careless or man-made installations, operation and maintenances upon machines without referring to the Manual prior to machine using.
2. Any incidents beyond human reasonable controls, which include man-made vicious or deliberate damages or abnormal power, and machine faults caused by irresistible natural disasters including fire, flood, storm and earthquake.
3. Any operational actions that are not authorized by Shini upon machine, including adding or replacing accessories, dismantling, delivering or repairing.
4. Employing consumables or oil media that are not appointed by Shini.

## 2. Structure Characteristics and Working Principle

### 2.1 Working Principle

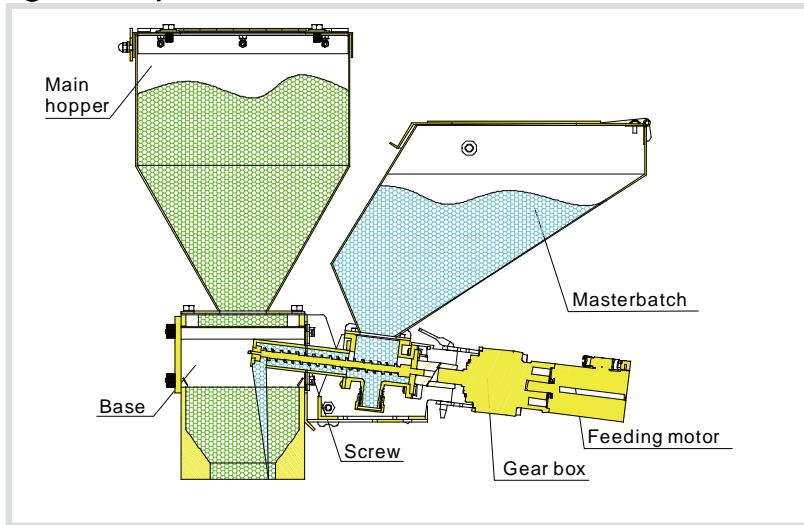

Picture 2-1: SCM Working Principle

## 2.2 Optional Accessories

### 2.2.1 Mixer

Mixer CMB-1 enhances the mixing uniformity



Optional Mixer

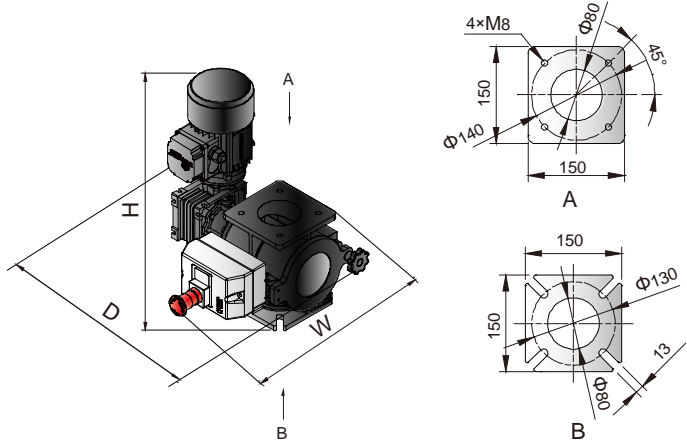

Mixer

Table 2-1: Specification

Model	Motor power(kw)	H(mm)	W(mm)	D(mm)
CMB-1	0.25	364	347	371

Notes: 1) Power supply: 3Φ, 400VAC, 50Hz

### 2.2.2 Main Hopper

The main material hopper is optional for both single and double color Doser basing on customer demand.

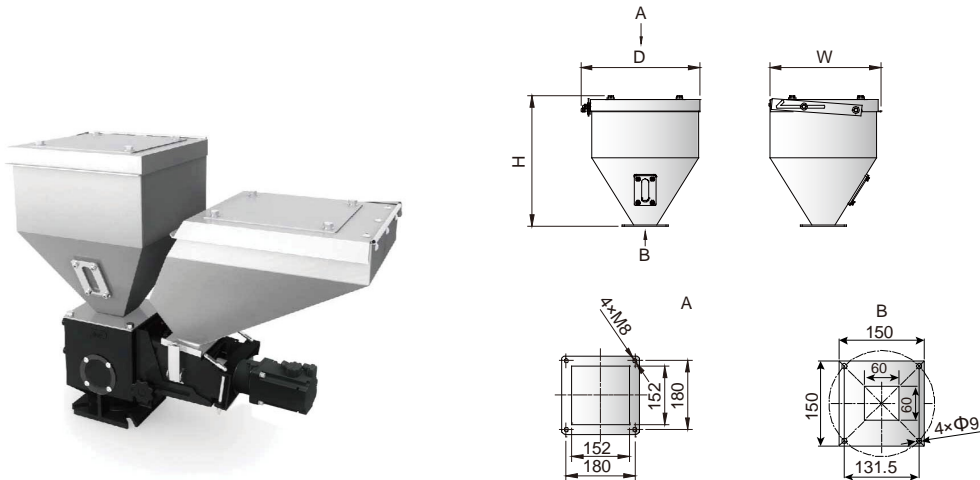

Table 2-2: Specification

Model	Capacity(L)	Material	H(mm)	W(mm)	D(mm)
MH-15	15	SUS201	340	314	293

### 2.2.1 Heavy base

Heavy base(Used with SEHD/SHD-E/SHD-EB-100~300 or SHD-160U~SHD-450U)

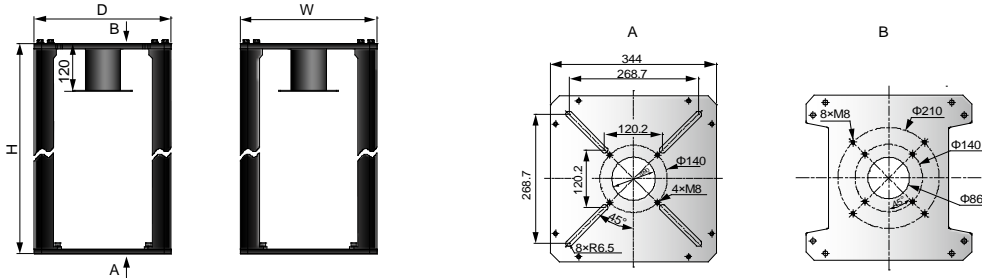

Table 2-3: Specification

Model	H(mm)	W(mm)	D(mm)
HB-1	332	344	344
HB-2	527	344	344

Notes:

- 1) When collocating with standard SCM, the model is HB-1
- 2) When collocating with standard SCM+CMB-1, the model is HB-2

### 2.2.2 Large Drying Hopper

Large drying hopper is worked with the heavy base

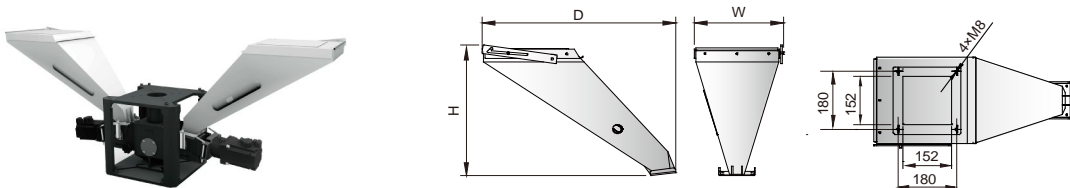

Table 2-4: Specification

Model	Capacity(L)	Material	H(mm)	W(mm)	D(mm)
LH-15	15	SUS201	411	608	281

Note:

When the long hopper is mounted with the auto conveying device, the total weight of the hopper shall not exceed 20KG(including the master batch).

### 3. Installation and Debugging

Read this chapter carefully before installation. Install the machine by following steps!

This series of models only could be applied in working environment with good ventilation.



Power supply of the machine should be done by qualified electricians!

#### 3.1 Install on Extrusion or Injection Molding Machine

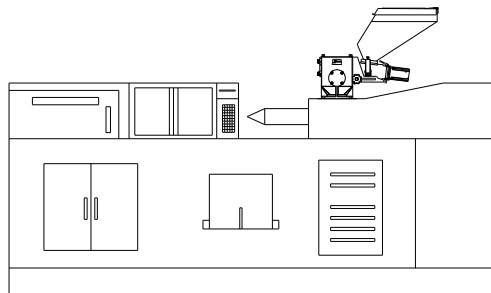

Picture 3-1: Installation of Single Color Doser

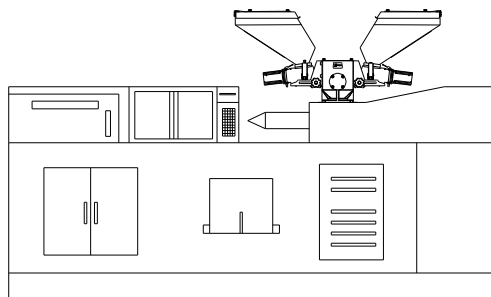

Picture 3-2: Installation of Double-color Doser

According to the specifications of mounting holes on the extruder or injection molding machine, drill 4 screw holes on the base of SCM machine. Install the whole machine on the extruder or injection molding machine by locking the 4 screws of the mounting base.

#### 3.2 Power Connection

- 1) Make sure the voltage and frequency of the power source comply with those indicated on the manufacturer nameplate that attached to the machine.

- 2) Power cable and earth connection should conform to your local regulations.
- 3) Use independent electrical wires and power switch. Diameter of electrical wire should not be less than those used in the control box.
- 4) The power cable connection terminals should be tightened securely.
- 5) The machine requires 3-phase 3-wire power source, connect the power lead (L1, L2, L3) to the live wires, and the earth (PE) to the ground.
- 6) Power supply requirements:  
Main power voltage: +/- 5%  
Main power frequency: +/- 2%
- 7) ***Please refer to electrical drawing of each model to get the detailed power supply specifications.***

### 3.3 Control Box Rear Button and Wiring

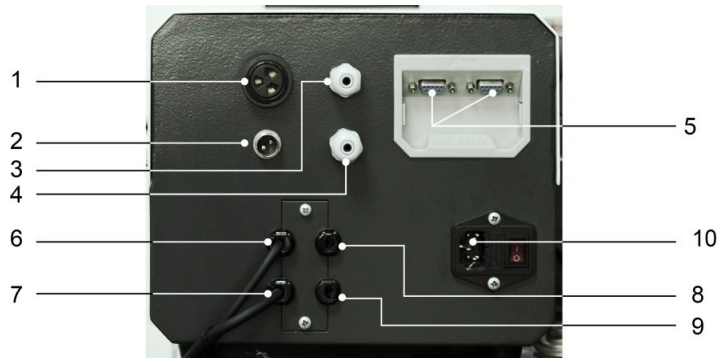

Picture 3-3: Control Box Rear Button and Wiring

Table 3-1: Specification

No.	Name	Function	Remarks
1	Buzzer	Alarm prompt	
2	Signal wire interface	Melt / extrusion input signal	
3	Level sensor 1	Hopper 1 low level signal input	
4	Level sensor 2	Hopper 2 low level signal input	
5	RS485 comm. port	Connect external RS485 interface	
6	Motor 1 power wire	Supply power to discharge motor 1	
7	Motor 1 encoder wire	Send signal to discharge motor 1	
8	Motor 2 power wire	Supply power to discharge motor 2	
9	Motor 2 encoder wire	Send signal to discharge motor 2	
10	Power inlet wire	Supply power to machine	Rated power 1Φ230VAC



## 4. Application and Operation

### 4.1 Operation Instruction

#### 4.1.1 Monitoring page

Enter the monitoring page after startup:

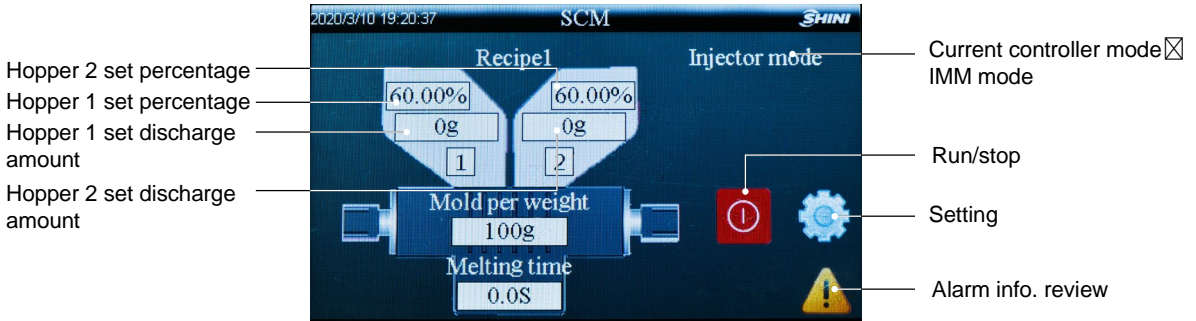

Picture 4-1: IMM Mode Monitoring Page

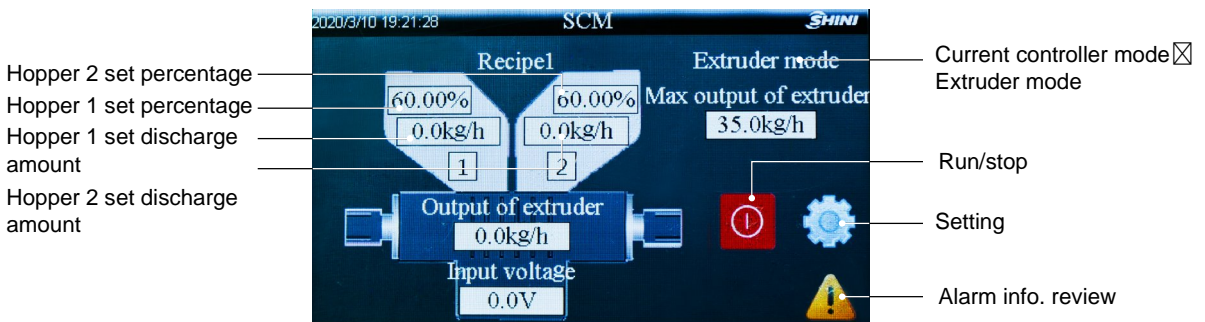

Picture 4-2: Extruder Mode Monitoring Page

#### 4.1.2 Machine Setting Screen

Click <Setting>button to enter the machine setting screen:



Picture 4-2: Machine Setting Screen

#### 4.1.3 Parameter Setting

Click the < Parameter Setting > button to enter the parameter setting page and

confirm the current running mode, IN-mode and melting signal type.

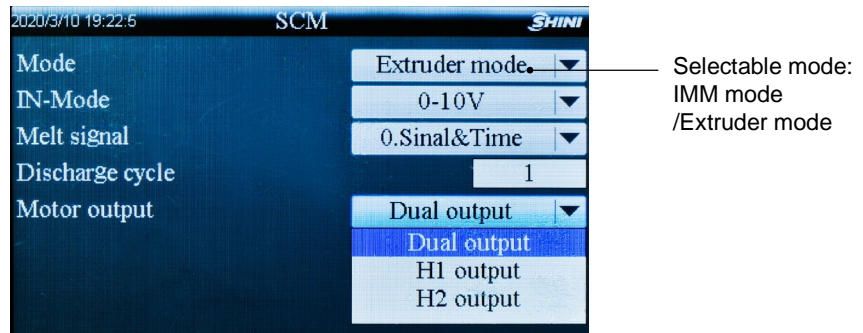

Picture 4-3: Parameter Setting Screen

### 1) IN-mode

When selecting the IMM mode, there are two IN-modes: 24V / short.

24V: the signal input voltage is 24V voltage

Short: the signal input type is dry contact short circuit

When selecting the extruder mode, there is only one IN-mode: 0 ~ 10V.

0~10V: the signal input power is 0 ~ 10V

### 2) Melting Signal

The melting signal control type (option: 0 ~ 3, factory default is 0):

0---External signal & melting time

1--- External signal: When the Doser works, the signal is determined by the external signal.

2 --- Melting time: When the color master works, the signal is determined by the set melting time signal.

3---Moulding time: When the Doser works, the signal is determined by the last mould melting time receiving signal

When the setting is 0, it means feeding time of Doser screw is determined either by external signal or set melting time, depending on whose lasting time is shorter. Such as: When the IMM signal ends, but the Doser set melting time is not completed, the Doser screw will stop feeding; When the IMM signal doesn't end, but the Doser set melting time is completed, the Doser screw will also stop feeding;

When it is set to 1, only when the external signal is disconnected, the Doser screw will stop conveying.

When it is set to 2, the Doser screw won't stop conveying until the melting time ends.

When it is set to 3, it takes the melting time of the last mould to drive the screw.

### 3) Discharge cycle

When the hopper 1's discharge cycle is set to 0 or 1, the Doser will set the next feeding according to the recipe once there's a melting signal.

When the recipe figures out that the dosage of each master batch mould is very small, e.g., it is calculated that the dosage of each master batch mould is 0.5g. At this time, in order to achieve the accurate metering purpose, the hopper 1's discharge cycle can be set to 2. Then, when the machine works, there're two melting signals, and the masterbatch outputs 1.0g master batch in total once. The hopper 2's setting is the same as that of hopper 1.

### 4) High and low electrical level / display decimal selection

On the parameter setting page, click the < Next > button to enter the high / low electrical level / display the decimal selection screen.

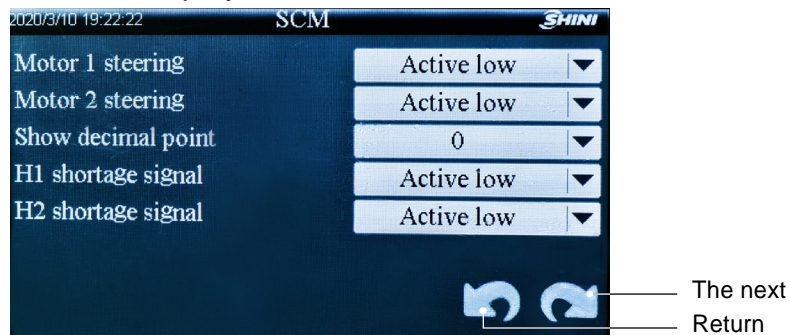

Picture 4-4: High and Low Elec. Level / Decimal Selection Screen

The low elec.level selected by motor turning is valid: the motor rotates clockwise.

The high elec.level selected by motor turning is valid: the motor rotates counterclockwise.

The low elec.level selected by hopper shortage signal is valid: the input shortage signal is normally-on.

The high elec.level selected by hopper shortage signal is valid: the input shortage signal is normally-closed.

Select 0 for display decimal: each module weight display is without decimal point

Select 0.1 for decimal display: each module weight display is with one decimal point



**Attention!**

***The factory default of motor turning/ hopper shortage signal is low electrical level valid. Don't change it at will to avoid serious consequences.***

5) Motor running speed selection

On the parameter setting screen, click the < Next > button to enter the running speed selection screen. In the "Running Speed", it can select low speed or high speed (running speed of factory default: low speed); There are two options for material shortage alarm shutdown: shutdown / not shutdown.

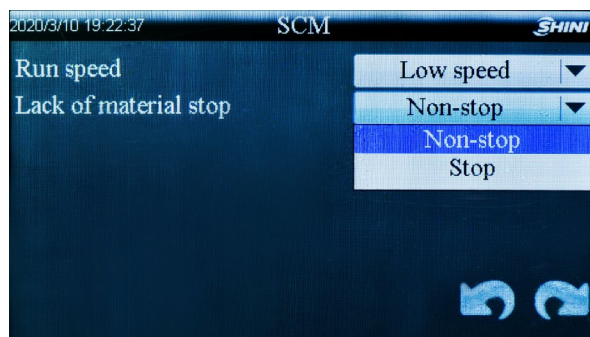

Picture 4-5: Running Speed / Alarm Shutdown Selection Screen

**Note: When current output can't meet the requirements, the running speed can be switched to high speed.**

4.1.4 50S Output Test Steps

50s output test is used to correct the master batch output, so as to ensure the stable and accurate Doser running. When replacing the master batch, it must carry out the 50S output test.

- 1) Before the 50s output test, it must fill the screw. Click the < Fill > button on the machine setting screen to enter the manual operation screen for screw filling.

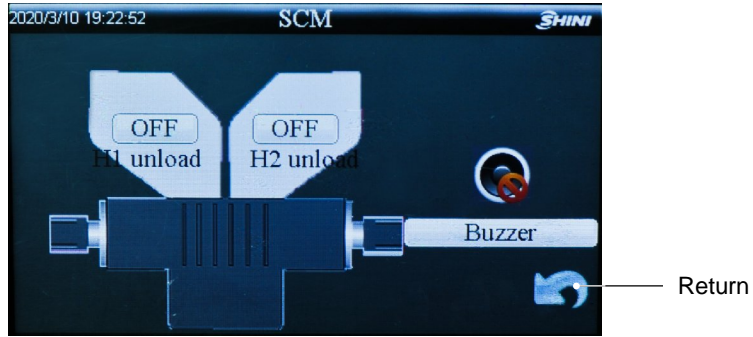

Picture 4-6: Manual Operation Screen

- 2) Click the < Hopper1 Fill > button, and the screw rotates to fill the screw device.

When the master batch outflow evenly at the screw outlet, it means that the screw filling is completed. Click the < Hopper1 Fill > button again to stop filling, and then press the <Return > button to exit the manual operation screen.

- 3) Click < Unit Setting > on the machine setting screen to enter the 50S output test screen.

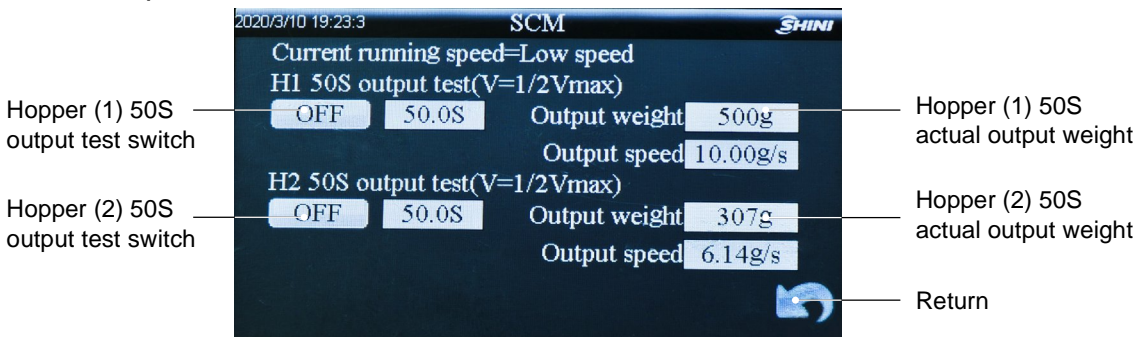

Picture 4-7: 50 Secs. Output Test Screen

- 4) Take out the fixed base, and use a container to collect the master batch at the screw outlet, press < Hopper (1) 50S Output Test Switch >, and the system will complete the 50S output operation automatically.

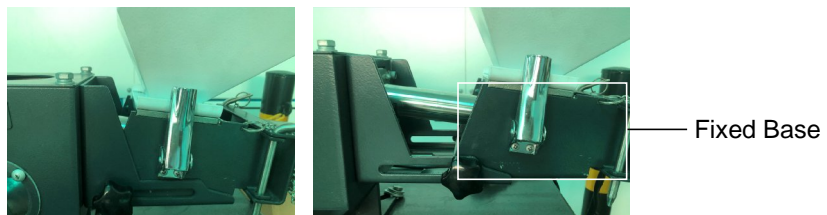

Picture 4-8 Fixed Base Taking-out Diagram

- 5) Take the master batch in the container onto the electronic scale to weigh, and input the weighed value into the "Hopper (1) 50S Actual Output Weight". Press the < Return > button to exit the 50S test screen, and the Hopper (1) 50S Max. Output Test is finished.
- 6) The hopper 2's 50S output test refers to the hopper 1's operation.

 **Attention!**

*It's suggested to make three 50S tests and take the average value.*

#### 4.1.5 Recipe Setting

##### 4.1.5.1 Injection molding machine mode

Click the < Recipe Setting > button on the machine setting screen to enter the recipe setting screen.

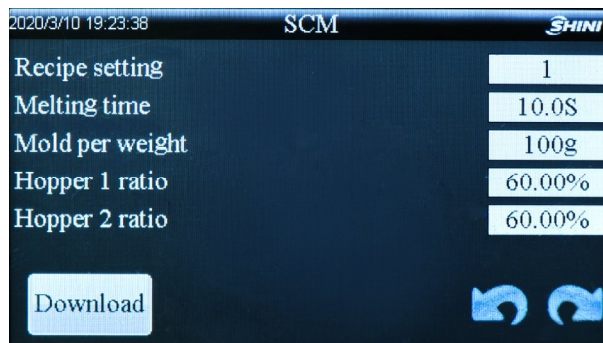

Picture 4-9: Recipe Setting Screen

On the recipe setting screen, enter the recipe serial number (1 ~ 50), hopper 1 ratio, hopper 2 ratio, melting time and weight per mould. After setting, click the < Download > button, and the recipe will be saved automatically.

##### 4.1.5.2 Extruder Mode

On the machine setting screen, click the < Recipe Setting > button to enter the setting screen, and enter the recipe serial number (1 ~ 50), hopper 1 ratio, hopper 2 ratio, and extruder max. capacity. After setting, click the < Download > button, and the recipe will be saved automatically.

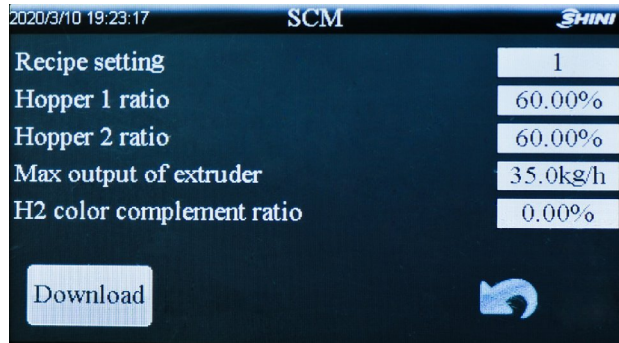

Picture 4-10: Recipe Editing Screen

**Note:** The color compensation ratio of the hopper 2 refers, when the hopper 2 is empty of recycled materials. The amount of compensation based on the color difference is compensated into the hopper 1.

#### 4.1.6 Run/Stop

Press the < run / stop > button to make it run.

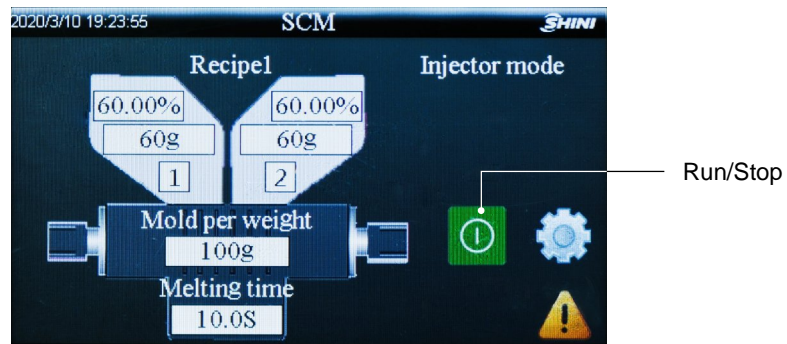

Picture 4-11: Run/Stop Screen

## 4.2 Other Parameters Function

### 4.2.1 Password management

On the machine setting screen, click the < Password Management > button, and it pops up the password login screen; The original password is 3588, click Enter button to enter the password modification screen; and click "3588" to reset the original password.

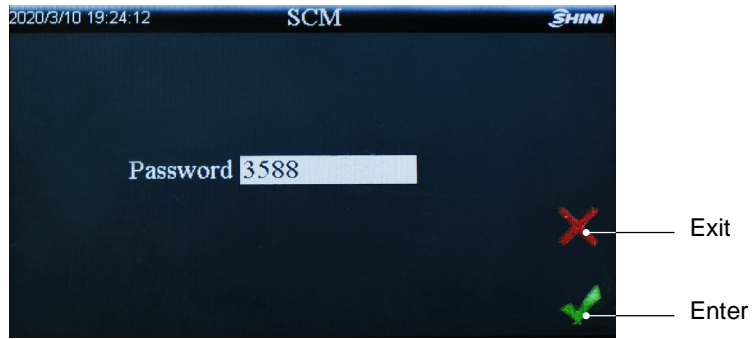

Picture 4-12: Password Log-in Screen

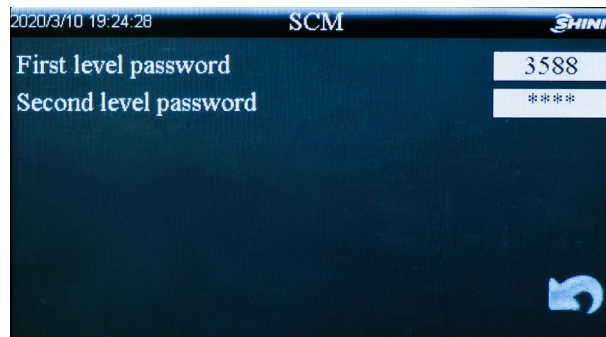

Picture 4-13: Password Modification Screen

#### 4.2.2 System Setting

On the machine setting screen, click <System Setting>button to enter the system setting screen, and it can set the time, communication address, select the language type, and download the data (it can download the recipe data or alarm records via the USB disk) on the screen.



Picture 4-14: Time Setting Screen





Picture 4-15: Comm. Address Setting Screen

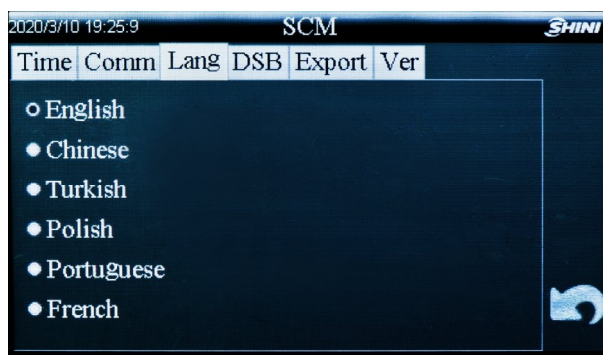

Picture 4-16: Language Setting Screen

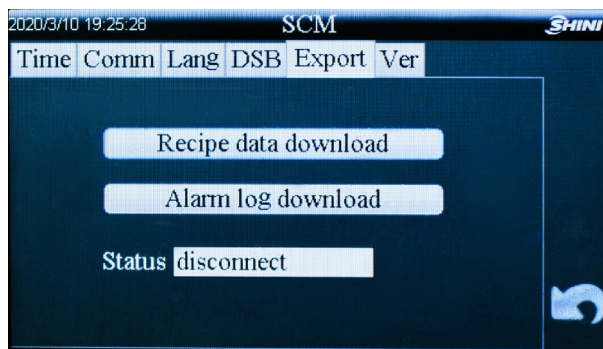

Picture 4-17: Data Download Screen

### 4.3 Material Replacement

- 1) Cut off the power supply, loosen the hopper snap hook, and remove the motor fixing pin and the hopper.
- 2) Unscrew the nut at the hopper discharge port, rotate the screw fixing plate, remove the screw, and blow off the residual master batch with the compressed air.

- 3) After cleaning, assemble them in reverse order, add feed the new master batch to replace the materials.
- 4) After replacing the new master batch, it has to take the 50S test again.

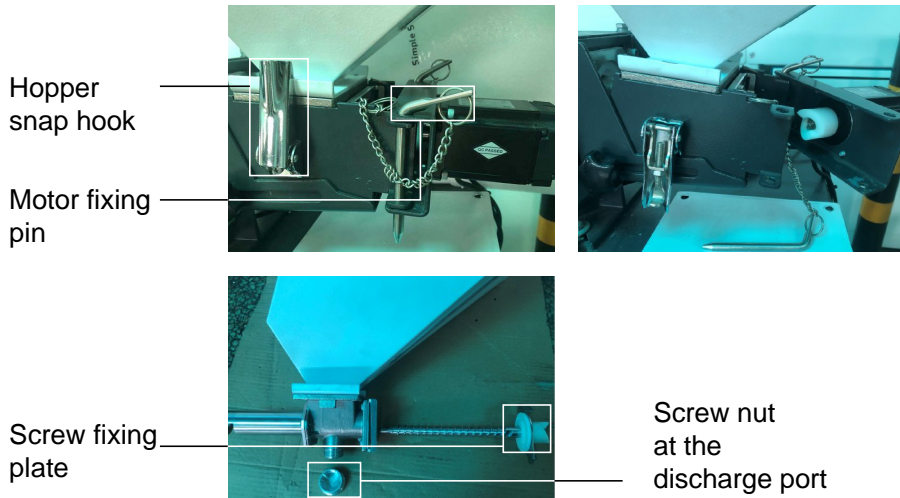

Picture 4-18: Material Replacement

## 5. Troubleshooting

Failures		Possible reasons	Solutions
No indicates on the control cabinet.		1. Power supply not connected.	1. Connect the power supply.
		2. Fuse burnt out or control board problems	2. Replace the fuse or check control board.
Buzzer alarm	Abnormal output speed alarm	1. Incorrect parameter input.	1. Reset parameters.
	Motor fault alarm	2. Motor overload.	2. Connect the power and then turn on the power again
		3. Motor damaged.	3. Replace the motor.
		4. Servo driver failure	4. Replace the driver failure
	Shortage alarm	5. Low level	5. Check the material inventory status
High input voltage alarm	6. High input voltage	6. Check the voltage at the signal supply terminal	

## 6. Maintenance and Repair

### 6.1 Repair

All the repair work should be done by qualified technicians to prevent personal injuries and damage of the machine.

### 6.2 Maintenance

Keep the surface of machine clean.

### 6.3 Maintenance Schedule

#### 6.3.1 About the Machine

Model: \_\_\_\_\_ No.: \_\_\_\_\_ Manufacturing date : \_\_\_\_\_  
Voltage: \_\_\_  $\Phi$  \_\_\_\_\_ V Frequency: \_\_\_\_\_ Hz Total power: \_\_\_\_\_ kW

#### 6.3.2 Check after Installation

- Check that dosing screws are fitted correctly.
- Check the snap hook is tightly locked.
- Check if the mounting base is firmly locked.

#### Electrical Installation

- Voltage: \_\_\_\_\_ V \_\_\_\_\_ Hz
- Fuse melt current: 1 Phase \_\_\_\_\_ A 3 Phase \_\_\_\_\_ A
- Power supply and signal wire of control cabinet are correctly connected.

#### 6.3.3 Daily Checking

- Check the main switch.
- Check fastening screws of mounting base.

#### 6.3.4 Weekly Checking

- Check if there damaged electrical wires.
- Check snap hooks are loose or not.
- Check if the side holding plate is loose or not.