

SDD-ES Series

Dehumidifying Dryer

Date: Oct. 2018

Version: Ver.F (English)



Contents

1. General Description	7
1.1 Coding Principle	8
1.2 Feature	8
1.3 Technical Specifications.....	10
1.3.1 Outline Drawing	10
1.3.2 Specifications	10
1.3.3 Drying Capacity	11
1.4 Safety Regulations	13
1.4.1 Safety Regulations for the Blowers.....	13
1.4.2 Safety Signs and Labels	14
1.4.3 Signs and Labels	15
1.4.4 Transportation and Storage of the Machine.....	15
1.5 Exemption Clause	17
2. Structure Characteristics and Working Principle	18
2.1 Working Principle	18
2.2 Relative Humidity and Dew-point	18
2.3 Why Choose SDD	19
2.4 Options.....	20
3. Installation Testing.....	21
3.1 Machine Location	21
3.2 Power Connectors.....	21
3.3 Air pipe and material pipe connection	22
3.4 Water connections	22
3.4.1 Cooling Water Connection.....	23
3.4.2 Condensation Drainage Pipe.....	24
3.5 Cyclone Dust Collector.....	24
3.6 Oil Filter.....	25
3.7 Plate Heat Exchanger	26
4. Operating.....	27
4.1 Operation Procedure for HMI	27

4.1.1	Description of touch screen	27
4.1.2	Touch panel appear error	27
4.1.3	Screen operation flow Table	28
4.1.4	Menu Particular	28
4.1.4.1	System Default Screen	28
4.1.4.2	Dehumidifying Process	29
4.1.4.3	Password Unlock	29
4.1.4.4	Working Modes of Regeneration Heater (Dehumidifying Function)32	
4.1.4.5	Working Modes of Material Drying	35
4.1.4.6	Alarms Fault Records.....	37
5.	Trouble-shooting	39
6.	Maintenance and Repair	41
6.1	The Useful Life of the Key Parts of the Product	42
6.2	Filter	42
6.3	Honeycomb-rotor	43
6.3.1	What is Honeycomb-rotor.....	43
6.3.2	Installation of the Rotor.....	43
6.3.3	Honeycomb Rotor Cleaning Steps	44
6.4	EGO	45
6.5	Cooler Clear Step.....	45
6.6	Dewpoint Monitor(Optional)	46
6.6.1	Installation for Dewpoint Monitor	46
6.6.2	Dew-point monitor setting.....	48
6.7	Maintenance Schedule.....	50
6.7.1	General Machine Information	50
6.7.2	Check After Installation.....	50
6.7.3	Daily Checking.....	50
6.7.4	Weekly Checking.....	50
6.7.5	Monthly Checking	51
6.7.6	Half-yearly Checking	51
6.7.7	Yearly Checking	51
6.7.8	3 year Checking.....	51

Table Index

Table 1-1: Specifications	10
Table 1-2: Drying Capacity 1	11
Table 1-3: Drying Capacity 2	12
Table 6-1: The useful life of the key parts of the product.....	42

Picture Index

Picture 1-1: Outline Drawing.....	10
Picture 1-2: Safety Regulations for The Blowers	14
Picture 2-1: Working Principle	18
Picture 3-1: Installation Drawing	21
Picture 3-2: Air Pipe and Material Pipe Connection Drawing.....	22
Picture 3-3: Cooling Water Connection.....	23
Picture 3-4: Installation Dia. of Cyclone Dust Collector.....	24
Picture 3-5: Installation Dia. of Oil Filter.....	25
Picture 3-6: Plate Heat Exchanger Over Figure.....	26
Picture 4-1: Description of Touch Screen	27
Picture 4-2: Screen Operation Flow Table.....	28
Picture 4-3: System Initial Screen.....	28
Picture 4-4: Dehumidifying Process Screen	29
Picture 4-5: Password Input Screen	29
Picture 4-6: Drying Process	30
Picture 4-7: Parameter Setting Menu Screen	30
Picture 4-8: Time Setting Screen.....	31
Picture 4-9: Parameter Setting	31
Picture 4-10: Parameter Setting Screen	32
Picture 4-11: Drying Process Screen.....	32
Picture 4-12: Dehumidify Process Screen	33
Picture 4-13: Parameter Setting Screen	33
Picture 4-14: Drying Process Screen.....	34
Picture 4-15: Dehumidify Process Screen	34

Picture 4-16: Drying Process Screen.....	35
Picture 4-17: Drying Process Screen.....	35
Picture 4-18: Recipe Setting Screen.....	36
Picture 4-19: Drying Process Screen.....	36
Picture 4-20: Drying Process Screen.....	37
Picture 4-21: Alarm Fault Records.....	37
Picture 6-1: Filter	42
Picture 6-2: Honeycomb Rotor	43
Picture 6-3: Installation of The Rotor	44
Picture 6-4: EGO	45
Picture 6-5: Hole Site.....	46
Picture 6-6: Parts of Dew-point Monitor	46
Picture 6-7: Copper Joint Assembly of Original Machine.....	47
Picture 6-8: Installation Seat.....	47
Picture 6-9: Installation for Transmitter	47
Picture 6-10: Connection of Signal Wire	48
Picture 6-11: Connection of Dew-point Monitor	48

1. General Description



Please read through this operation manual before using the machine to prevent damages of the machine or personal injuries.

SDD series dehumidifying dryer combine dehumidifying and drying systems into a single unit. They have many applications in processing plastic materials, such as PA, PC, PBT, PET etc. All models feature SD-H honeycomb dehumidifiers with built-in process heater and insulated drying hopper. Under ideal conditions, it can provide dehumidified dry air with a dew-point lower than -40°C .



SDD-160U/120H-LC-D



SDD-80U/50H

1.1 Coding Principle

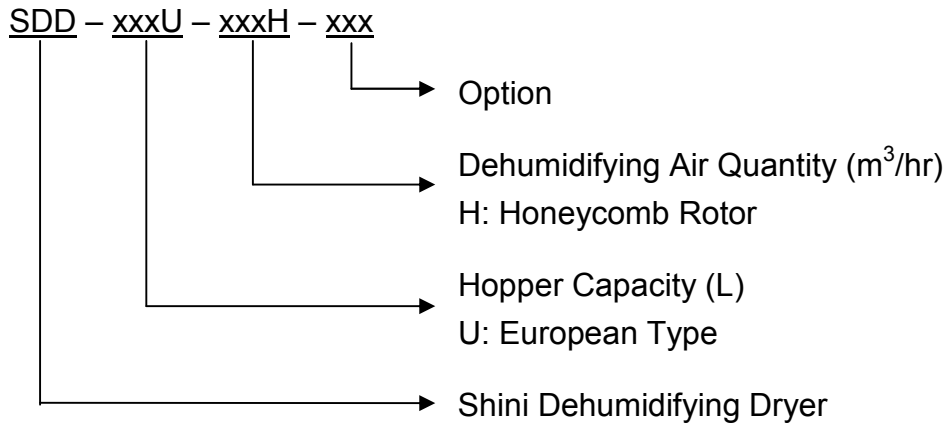

1.2 Feature

- The SDD dehumidifying dryer use honeycomb dehumidifiers with an eye-catching semi-integral appearance.
- Each model combines dehumidifying and drying functions into a single unit.
- Insulated drying hopper features dry air down-blowing and cyclone exhaust design. This improves drying efficiency and reduces energy consumption while maintain a steady drying effect.
- The dehumidifying section of the SDD series features two coolers to ensure a low return air temperature and low dew-point.
- Compact in size for ease of movement and space saving.
- Microprocessor is the standard equipment.

All service work should be carried out by a person with technical training or corresponding professional experience. The manual contains instructions for both handling and servicing. Chapter 6, which contains service instructions intended for service engineers. Other chapters contain instructions for the daily operator.

Any modifications of the machine must be approved by SHINI in order to avoid personal injury and damage to machine. We shall not be liable for any damage caused by unauthorized change of the machine.

Our company provides excellent after-sales service. Should you have any problem during using the machine, please contact the company or the local vendor.

Headquarter and Taipei factory:

Tel: (886) 2 2680 9119

Shini Plastics Technologies (Dongguan), Inc:

Tel: (86) 769 8111 6600

Shini Plastics Technologies India Pvt.Ltd.:

Tel: (91) 250 3021 166

1.3 Technical Specifications

1.3.1 Outline Drawing

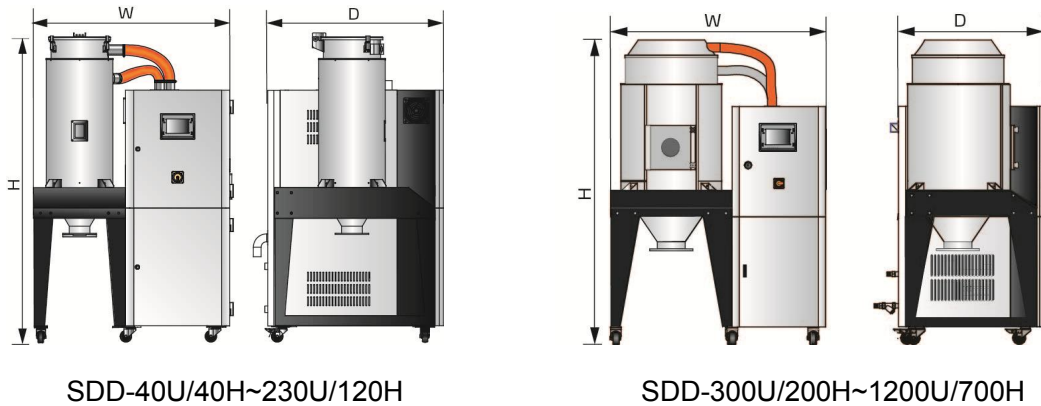

Picture 1-1: Outline Drawing

1.3.2 Specifications

Table 1-1: Specifications

Model-SDD	Ver.	Regen. Heater (kW) (50/60Hz)	Regen. Blower (kW) (50/60Hz)	Drying Heater (kW)	Drying Blower (kW) (50/60Hz)	Dry Air Volume (m ³ /hr) (50/60Hz)	Insulated Hopper (L)	Dimension (mm) H×W×D	Weight (kg)
40U/40H	E	3	0.12	4	0.12	40	40	1509×978×931	165
80U/40H	E	3	0.12	4	0.12	40	80	1796×1060×1030	190
120U/80H	D	3	0.4	4	0.75	80	120	1817×1061×893	250
160U/80H	D	3	0.4	4	0.75	120	160	2070×1061×893	255
160U/120H	D	4	0.4	6	0.75	120	160	2070×1060×893	265
230U/120H	D	4	0.4	6	0.75	120	230	2052×1210×893	295
300U/200H	D	4	0.4	12	1.5	200	300	2040×1450×1050	420
450U/200H	D	4	0.4	12	1.5	200	450	2440×1450×1050	550
600U/400H	C	7.2	0.75	18	3.75	400	600	2380×1745×1255	620
750U/400H	C	7.2	0.75	18	3.75	400	750	2610×1745×1255	650
900U/700H	D	10	1.5	24	7.5	700	900	2640×2140×1380	830
1200U/700H	F	10	1.5	24	7.5	700	1200	3070×2140×1380	870

Note: 1) Plastic materials can be fully dried by drying air with dew-point temperature $\leq 20^{\circ}\text{C}$. When ambient temperature $\leq 25^{\circ}\text{C}$ and relative humidity $\leq 60\%$, the drying air dewpoint temp. $\leq 40^{\circ}\text{C}$.

2) Power: 3 Φ , 230 / 400 / 460 / 575VAC, 50 / 60Hz.

We reserve the right to change specifications without prior notice.

1.3.3 Drying Capacity

Table 1-2: Drying Capacity 1

Material	Drying Temp. (°C)	Drying Time (hr)	Drying Capacity (kg/hr)							
			40U /40H	80U /40H	120U /80H	160 /80H	160U /120H	230U /120H	300U /200H	450U /200H
ABS	80	2-3	16	18	27	27	35	105		
CA	75	2-3	12	15	22	22	29	90		
CAB	75	2-3	12	15	22	22	29	90		
CP	75	2-3	16	18	27	27	35	106		
LCP	150	4	11	13	40	40	27	80		
POM	100	2	24	27	40	40	53	160		
PMMA	80	3	17	19	29	29	38	115		
IONOMER	90	3-4	10	11	17	17	22	66		
PA6/6.6/6.10	75	4-6	9	10	14	14	19	58		
PA11	75	4-5	10	11	17	17	23	69		
PA12	75	4-5	10	12	17	17	23	69		
PC	120	2-3	18	21	31	31	41	124		
PU	90	2-3	17	19	29	29	38	115		
PBT	130	3-4	13	15	23	23	31	93		
PE	90	1	47	53	80	80	106	318		
PEI	150	3-4	11	13	20	20	27	80		
PET	160	4-6	11	13	19	19	25	75		
PETG	70	3-4	11	13	20	20	27	80		
PEN	170	5	13	15	23	23	30	90		
PES	150	4	13	15	23	23	30	90		
PPO	110	1-2	19	22	33	33	44	133		
PPS	150	3-4	11	13	20	20	27	80		
PI	120	2	24	27	40	40	53	160		
PP	90	1	39	44	66	66	88	265		
PS(GP)	80	1	39	44	66	66	88	265		
PSU	120	3-4	12	14	22	22	29	86		
PVC	70	1-2	19	22	33	33	44	133		
SAN(AS)	80	1-2	19	22	33	33	44	133		
TPE	110	3	18	21	31	31	41	124		

Note: 1. Please refer to above drying capacity of SCD machine, select the right model according to material usage of processing machine.

2. Specific model selection, please consult the letter easy service personnel.

Table 1-3: Drying Capacity 2

Material	Drying Temp. (°C)	Drying Time (hr)	Drying Capacity (kg/hr)			
			600U /400H	750U /400H	900U /700H	1200U /700H
ABS	80	2-3	210		355	
CA	75	2-3	180		295	
CAB	75	2-3	180		295	
CP	75	2-3	210		355	
LCP	150	4	160		365	
POM	100	2	320		530	
PMMA	80	3	230		383	
IONOMER	90	3-4	133		220	
PA6/6.6/6.10	75	4-6	115		192	
PA11	75	4-5	138		230	
PA12	75	4-5	138		230	
PC	120	2-3	250		413	
PU	90	2-3	230		383	
PBT	130	3-4	186		310	
PE	90	1	637		1062	
PEI	150	3-4	160		265	
PET	160	4-6	150		250	
PETG	70	3-4	160		265	
PEN	170	5	180		300	
PES	150	4	180		300	
PPO	110	1-2	265		440	
PPS	150	3-4	160		265	
PI	120	2	320		530	
PP	90	1	530		885	
PS(GP)	80	1	531		885	
PSU	120	3-4	173		290	
PVC	70	1-2	265		442	
SAN(AS)	80	1-2	265		442	
TPE	110	3	250		413	

Note: 1. Please refer to above drying capacity of SCD machine, select the right model according to material usage of processing machine.

2. Specific model selection, please consult the letter easy service personnel.

1.4 Safety Regulations



Warning!

Electrical installation should be done by qualified technician only. Before connecting to AC Power Source, turn power switch to OFF position.

While AC power source is connected, make sure specifications and overload protection rating of the power switch are suitable and reliable.

When the machine is under care or maintenance status, turn both power switch and automatic operation switch to off.

1.4.1 Safety Regulations for the Blowers

- 1) Under normal operation, the blowers will generate high temperature. Do not touch blower's case to avoid any physical injury.
- 2) Under normal operation, the blower motor's current loading will increase or reduce according to air pressure's change accordingly. While installation, an adequate motor overload protection switch should be installed with full loading test, to ensure operating safely under full-loading to avoid motor's damage.
- 3) To avoid any block materials, dust, powder, fiber particles and water drops entering the blower, and hence cause the deficiency of its performance. This machine is well designed with air filters, so please clean up the filter with any foreign particles (recommended to clean up this filter weekly).
- 4) Clean the blowers both internal and external parts (especially for the fan cooling path), and remove surface dust if necessary. If more dusts are accumulated, it will cause deficiency for ventilation, temperature rising, vacuum power reduced, vibration increased and so it will cause machine broke down.
- 5) Ball bearing, oil seal and soundproof are belonging to consumable parts and so it has a life period and requires regular replacement. Meanwhile, blade, external case, and metallic screen etc. should be replaced regularly for best performance.
- 6) Under normal operation, if the blowers are not running smoothly or abnormal noise appeared. Please immediately shut down the machine for

repair.

- 7) Don't manual discharge material inside the hopper while its not or opening cleaning door while the material is not.

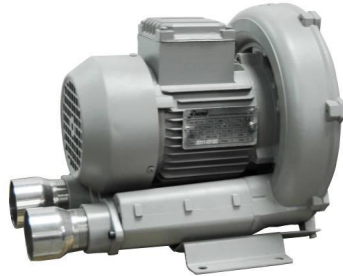

Picture 1-2: Safety Regulations for The Blowers

1.4.2 Safety Signs and Labels



Danger!

High voltage danger!

This label is stuck on the electrical boxes.



Attention!

This label means that this area should be taken care!



Warning!

High temperature, take care of hands!



This label should be stick to the shell of heater.



Attention!

No need for regular inspection because all the electrical parts in the control unit are fixed tightly!

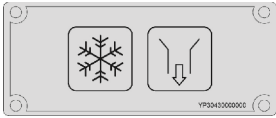
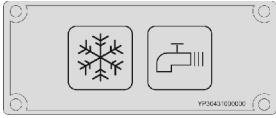
1.4.3 Signs and Labels

	<p>Hot surfaces can burn hands.</p>
	<p>Water outlet: drainage outlet.</p>
	<p>Water inlet: inlet for replenishing water and cooling water.</p>
	<p>Push-and-pull switch for shut-off plate: I: Means "Pull" O: Means "Push"</p>

1.4.4 Transportation and Storage of the Machine

Transportation

- 1) SDD series dehumidifying dryer are packed in crates or plywood cases with wooden pallet at the bottom, suitable for quick positioning by fork lift.
- 2) After unpacked, castors equipped on the machine can be used for ease of movement.
- 3) Do not rotate the machine and avoid collision with other objects during transportation to prevent improper functioning.
- 4) The structure of the machine is well-balanced, although it should also be handled with care when lifting the machine for fear of falling down.
- 5) The machine and its attached parts can be kept at a temperature from -25°C to $+55^{\circ}\text{C}$ for long distance transportation and for a short distance, it can be transported with temperature under $+70^{\circ}\text{C}$.

Storage

- 1) SDD series dehumidifying dryer should be stored indoors with temperature kept from 5°C to 40°C and humidity below 80%.
- 2) Disconnect all power supply and turn off main switch and control switch.

- 3) Keep the whole machine, especially the electrical components away from water to avoid potential troubles caused by the water.
- 4) Plastic film should be used to protect the machine from dust and rains.

Working environment

Indoors in a dry environment with max. temperature +45°C and humidity no more than 80%.

Do not use the machine

- 1) If it is with a damaged cord.
- 2) On a wet floor or when it is exposed to rain to avoid electrical shock.
- 3) If it has been dropped or damaged until it is checked or fixed by a qualified serviceman.
- 4) This equipment works normally in the environment with altitude within 3000m.
- 5) At least a clearance of 1m surrounding the equipment is required during operation. Keep this equipment away from flammable sources at least two meters.
- 6) Avoid vibration, magnetic disturbance at the operation area.

Rejected parts disposal

When the equipment has run out its life time and can not be used any more, unplug the power supply and dispose of it properly according to local code.

Fire hazard



In case of fire, CO₂ dry powder fire extinguisher should be applied.

1.5 Exemption Clause

The following statements clarify the responsibilities and regulations born by any buyer or user who purchases products and accessories from Shini (including employees and agents).

Shini is exempted from liability for any costs, fees, claims and losses caused by reasons below:

1. Any careless or man-made installations, operation and maintenances upon machines without referring to the Manual prior to machine using.
2. Any incidents beyond human reasonable controls, which include man-made vicious or deliberate damages or abnormal power, and machine faults caused by irresistible natural disasters including fire, flood, storm and earthquake.
3. Any operational actions that are not authorized by Shini upon machine, including adding or replacing accessories, dismantling, delivering or repairing.
4. Employing consumables or oil media that are not appointed by Shini.

2. Structure Characteristics and Working Principle

2.1 Working Principle

Moisture hot air from drying hopper is blown into rotor after flowing through cooler. Moisture from the air is dried by rotor and is then adsorbed by regeneration heating air. Two strands of airflow function on the rotor. And with the rotation, moisture from the air is absorbed and expelled after absorbed regeneration air to form stable low dew-point air, which is dried and heated to the drying temperature and then is blown into material barrel to closed circle to dry material.

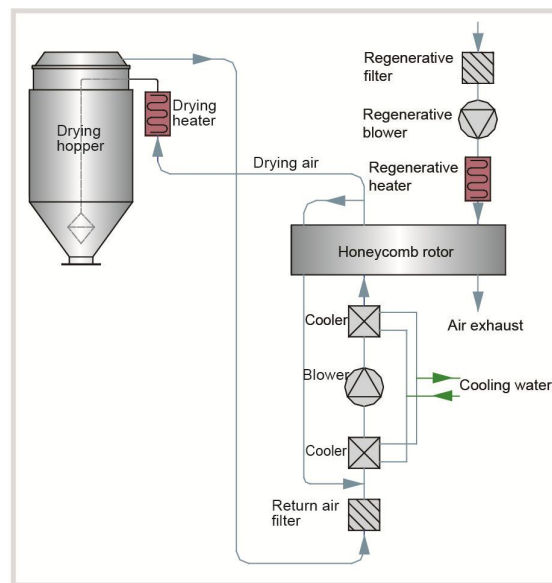

Picture 2-1: Working Principle

2.2 Relative Humidity and Dew-point

Relative humidity: Relative air humidity means real vapor content to saturated vapor at the same temperature in percentage.

Dew point: it means that temperature when the saturation vapor begins to dew. When the relative humidity is 100%, the ambient temperature is the dew point temperature. The more lower of dew point temperature (than the ambient temperature) is, the more less possible to dew, that also means the more drier the air is. The dew point will not be influenced by temperature, but influenced by pressure.

2.3 Why Choose SDD

For these quality deficiencies as bubble, crazing, cracking, poor transparency are due to insufficient drying of plastic materials before molding, and the engineering plastics such as: PC, PA, PBT, PET, Nylon, etc. The hygroscopic materials used in the plastics industry such as PC, PA, PBT, PET, Nylon, etc. cannot be dried effectively by conventional hot air drying systems because the moisture enters inside the particles. According to suggestion of the manufacturer, the plastic materials can be completely dried by drying air with dew-point temperature $\leq -20^{\circ}\text{C}$. However, the SCD sufficiently dehumidifies and dries the air inside the closed-loop system, and the dry air eliminates the moisture fast and completely as to reach the drying and dehumidifying effect.

2.4 Options

- Built-in type, which means that dew-point monitor is installed on the machine, is convenient to monitor dew-point temperature. Add "D" at the end of the model code.
- Portable type, which means that dew-point monitor is separate from the machine, is convenient to test dew-point temperature of different machines. Add "PD" at the end of the model code.



Dew-point Monitor (portable)

- For models optional with dew-point control, add "DC" at model behind. "ES" by setting if dew-point value to control the regeneration required temperature automatically and lowers power consumption of the regenerative heater; According to $-40^{\circ}\text{C}\sim+10^{\circ}\text{C}$ of dew-point value, the total power consumption can save 0~10%.
- For models with energy-saving drying management, add "ES" at model behind, standard equipped with HMI touch control, which can save up to 41% of total power consumption. Volume used per hour is settable between 40~100% as drying capacity to save the totally power consumption of 35%~0; Standard equipped with heat regenerative recycler which recycles the regeneration air exhausted heat via plate heat exchanger and can save 3%~6% of total power consumption.
- For models optional with drying heat recycler, add "HE" at model behind. Dehumidified low temperature air via plate heat exchanger to recycle the heat of hot-wet return air, which can higher the air temperature in drying heater and lower the power consumption of the heater, the total power consumption can save 0%~19%.
- For models with hopper polished inside, at "P" at the end of the mode code.

3. Installation Testing

This series of models only could be applied in working environment with good ventilation.

3.1 Machine Location



Picture 3-1: Installation Drawing

Installation Notice:

- 1) The machine can only be installed in the vertical position, make sure there's no pipeline, fixed structure and other object which may obstruct machine installation or cause items, human injuries above the selected location and adjacent areas.
- 2) For easy maintenance, leaving 1m space around machine is suggested. Keep machine 2m away from the inflammable materials.
- 3) The machine must be placed on the ground level to ensure balance state, and to remove the accumulated condensing water. If machine is need to install on a higher level (scaffolding or interlayer), it should make sure that the structure and size could withstand the machine.

3.2 Power Connectors

- 1) Make sure voltage and frequency of the power source comply with those indicated on the manufacturer nameplate, which is attached to the machine.
- 2) Power cable and earth connections should conform to your local regulations.

- 3) Use independent power cable and ON/OFF switch. The cable's size should not smaller than those wired in the electrical requirement of control panel.
- 4) The power cable connection terminals should be tightened securely.
- 5) The machine requires a 3-phase 4-wire power source, connect the power lead (L1, L2, L3) to the live wires, and the earth (PE) to the ground.
- 6) Power supply requirements:
 Main power voltage: $\pm 5\%$
 Main power frequency: $\pm 5\%$
- 7) Refer to the electrical wiring diagram to complete the electrical installation.

3.3 Air pipe and material pipe connection

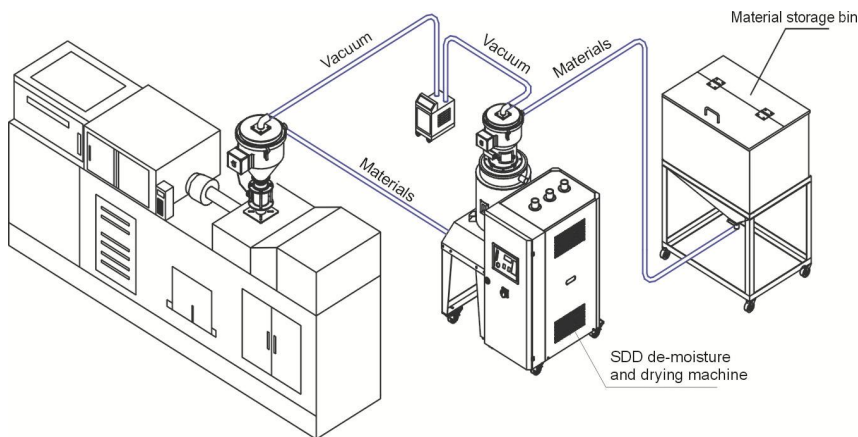

Picture 3-2: Air Pipe and Material Pipe Connection Drawing

3.4 Water connections

The cooling water pressure is 3~5bar and the cooling water temperature should be 10~30°C.

	<p>Water outlet: cooling water outlet.</p>
	<p>Water inlet: inlet for replenishing water and cooling water.</p>

Cooling water needs to be connected the before operation. The water port is at the back of the machine.

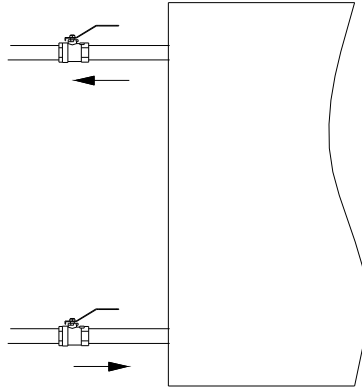

Picture 3-3: Cooling Water Connection

3.4.1 Cooling Water Connection

Connect through the cooling water before machine operation. For the efficiency, please follow below suggestions:

- 1) For easy maintenance and safety, install the ball valve at cooling water inlet and outlet.
- 2) Water pipe diameter should not less than the diameter of cooling water inlet and outlet.
- 3) For water quality, it needs to sediment or filter the water before it gets into the pipe, to prevent the deposits accumulated on pipeline of cooler and performance degradation.

Cooling Water Specifications			
Model	Flowrate of Cooling Water (L/min)	Model	Flowrate of cooling Water (L/min)
30H	4	400H	50
40H	5	500H	60
50H	6	700H	80
80H	10	1000H	120
120H	15	1500H	180
150H	20	2000H	240
200H	30	3000H	360
300H	40	4000H	480

Note: 1. Difference in temperature: 5°C
 2. Cooling water pressure: 3~5Kgf/cm²

3.4.2 Condensation Drainage Pipe

During normal operation, it will generate condensation water. Connect the water pipe at drainage outlet to remove the condensation water is necessary.

- 1) Drainage pipe inner diameter should not less than the diameter of drainage outlet.
- 2) Drainage pipe should be long enough to approach the drainage channel, and be the hose. Be careful not to press or bend the pipe for smooth water flow (Use the rigid pipe if there's need to press or bend the hose).
- 3) As condensation water drainage is in terms of gravity, make sure the drainage outlet is above the pipe. Otherwise the water can't be drained out and will flow back to the machine.

3.5 Cyclone Dust Collector

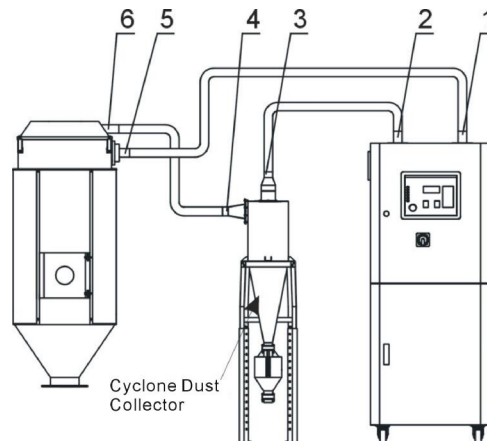

Picture 3-4: Installation Dia. of Cyclone Dust Collector

Cyclone Dust Collector Installation Steps:

- 1) Connect 1 and 5 with a heat-resistant duct and fixed both the ends with stainless steel tube.
- 2) Connect 2 and 3 with a heat-resistant duct and fixed both the ends with stainless steel tube.
- 3) Connect 4 and 6 with a heat-resistant duct and fixed both the ends with stainless steel tube.

3.6 Oil Filter

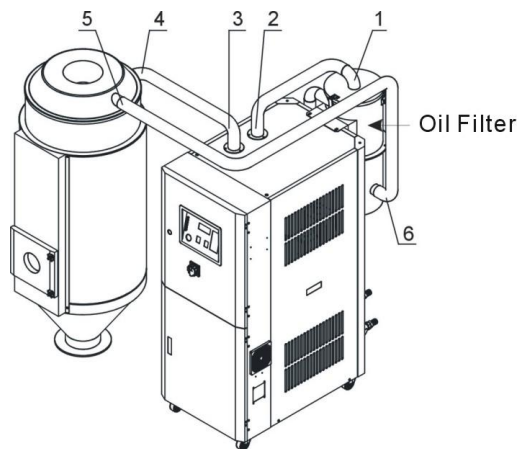

Picture 3-5: Installation Dia. of Oil Filter

Oil Filter Installation Steps:

- 1) Screw the oil filter on the top plate of the honeycomb dehumidifier.
- 2) Connect 1 and 2 with a heat-resistant duct and fixed both the ends with stainless steel tube.
- 3) Connect 3 and 4 with a heat-resistant duct and fixed both the ends with stainless steel tube.
- 4) Connect 5 and 6 with a heat-resistant duct and fixed both the ends with stainless steel tube.

3.7 Plate Heat Exchanger

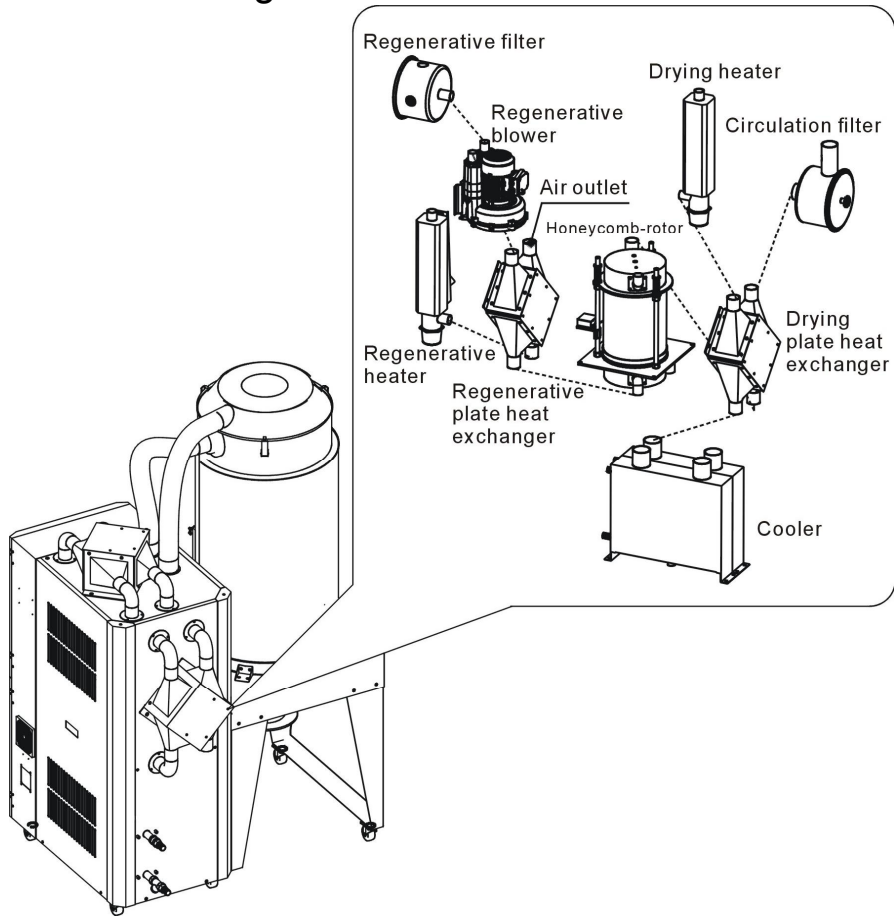

Picture 3-6: Plate Heat Exchanger Over Figure

Each part is connected by heat-resistant air pipes and fixed by stainless steel pipes as shown in the diagram.

4. Operating

4.1 Operation Procedure for HMI

- 1) Do not use keen-edged object instead of hands to operate the touch screen, and prevent violent collision of it.
- 2) In a dry environment, static electricity may accumulate on the touch screen. Use a metal wire to discharge it before operating.
- 3) Use alcohol or eleoptene to wipe off the pollutants on the screen. Other solvent may cause the color of the screen to fade out.
- 4) Do not tear down any parts of the touch screen or take away any PCBs attached to it.

4.1.1 Description of touch screen



Picture 4-1: Description of Touch Screen

A: Display

B: Touch panel

4.1.2 Touch panel appear error

Table 4-1: Touch Panel Information

LED indicator light	State
Green (light)	Work well
Orange (light)	Backlight lamp burning
Orange (shine)	During software startup
Red (light)	Power status
No shine	Power break off

4.1.3 Screen operation flow Table

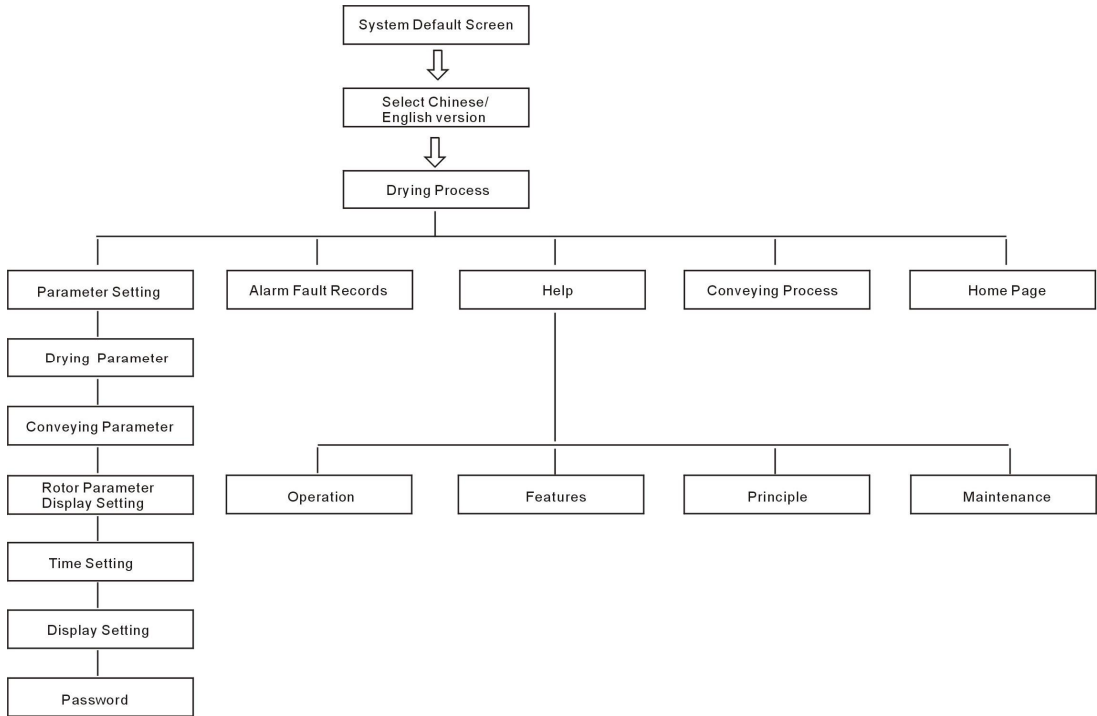

Picture 4-2: Screen Operation Flow Table

4.1.4 Menu Particular

4.1.4.1 System Default Screen

When the system is connected with power source, the initial default screen will display as shown below. By touching the button of "English" or "Chinese" to select either English or Chinese language in order to login "Drying Process" screen.

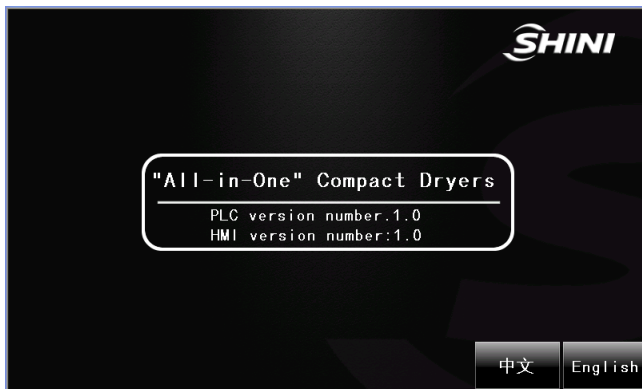

Picture 4-3: System Initial Screen

4.1.4.2 Dehumidifying Process



Picture 4-4: Dehumidifying Process Screen

4.1.4.3 Password Unlock

- 1) Input user name: shini
- 2) Input password: 3588
- 3) Press “Unlock”
- 4) Press “Return”, finish unlocking.

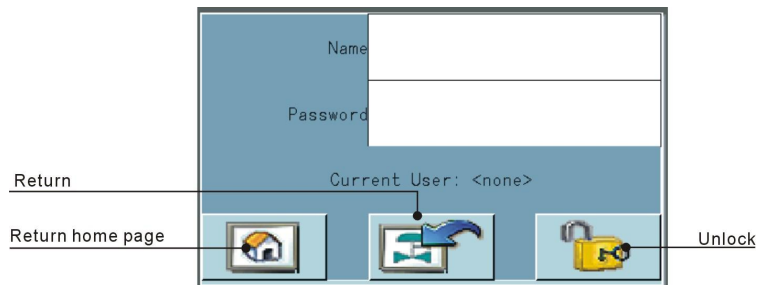

Picture 4-5: Password Input Screen

Note: Administrator password: 3333, Name: shiniwx,

Press  in dehumidifying control screen to enter drying monitor screen.



Picture 4-6: Drying Process

Press parameter setting button  in dehumidifying process screen to enter parameter settings menu screen.



Picture 4-7: Parameter Setting Menu Screen

When using weekly-timer mode, press weekly-timer function button  to enter weekly-timer screen and set one-week timer function.



Picture 4-8: Time Setting Screen

Press parameter settings button  to enter parameter setting screen.

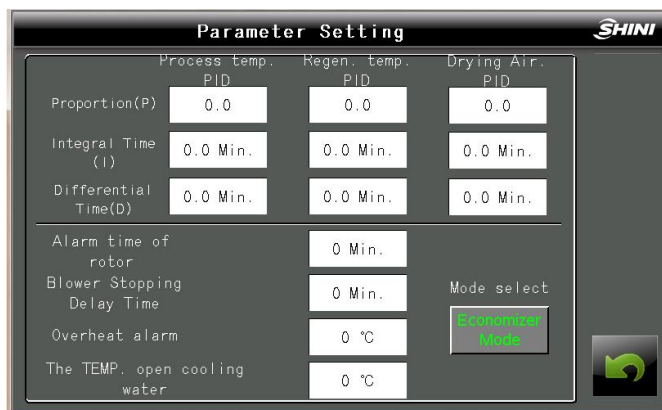

Picture 4-9: Parameter Setting

Rotor alarm time: Used to detect whether honeycomb rotor is rotating. Factory setting is 10min.

Blower stop delay time: When turning off the machine, blower's stop will be delayed to cool down the heat inside heater box to prevent the temperature inside the box keeps rising after machine's turning off. Factory setting is 3min.

Overheat alarm: Used for protection by preventing the system temperature rise beyond the temperature range. Factory setting is 15°C.

Cooling water temperature setting: Cooling water is used when the temperature is above the set temperature. Factory setting is 60°C.

4.1.4.4 Working Modes of Regeneration Heater (Dehumidifying Function)

A. Regeneration Mode

Setting Steps:

- 1) Enter parameter setting screen, press mode button, choose regeneration mode.

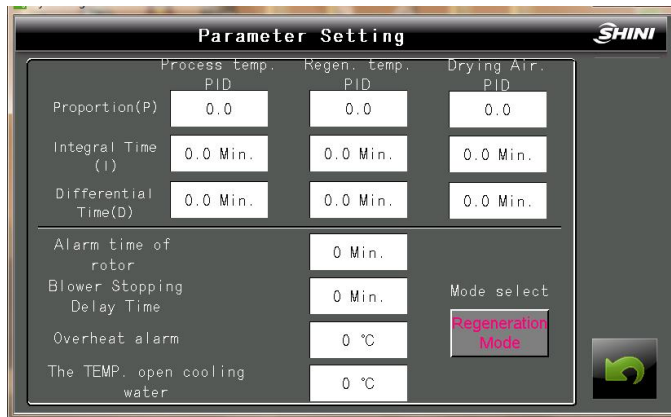

Picture 4-10: Parameter Setting Screen

- 2) Enter drying control screen, set material drying temperature and air volume.

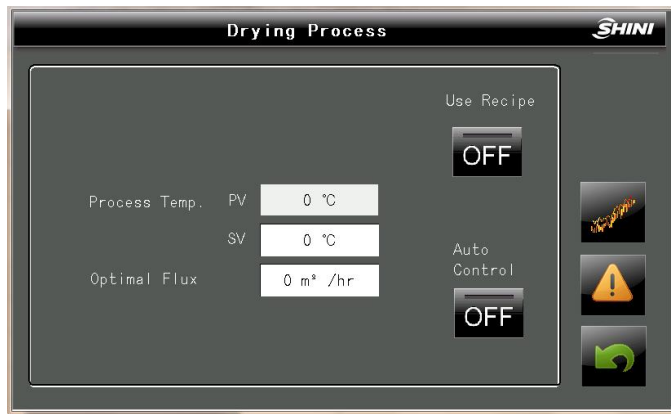

Picture 4-11: Drying Process Screen

- 3) Set regeneration temperature (180°C)



Picture 4-12: Dehumidify Process Screen

4) Press button, machine will start-up..

Note: In this mode, regeneration temperature and drying air volume of the machine are constant. Machine will operate under a setting drying temperature, air volume and regeneration temperature.

B. Energy saving mode

1) Enter parameter setting screen, press , choose energy saving mode.

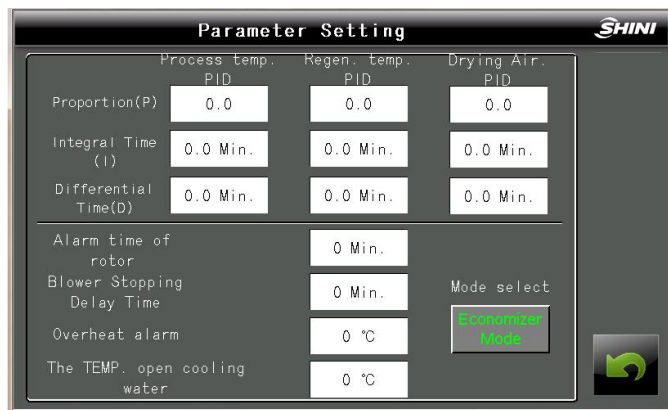

Picture 4-13: Parameter Setting Screen

2) Enter drying control screen, set material drying temperature and air volume.

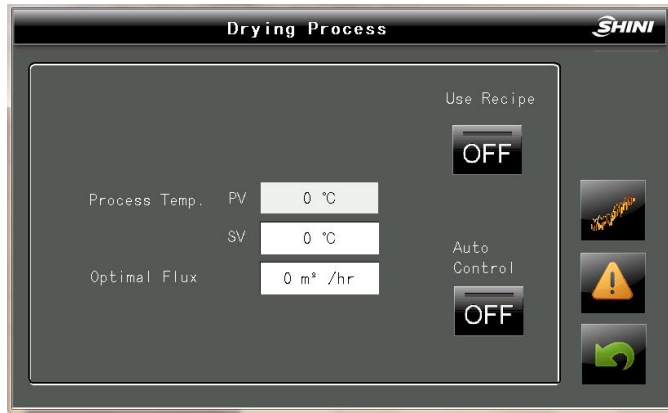

Picture 4-14: Drying Process Screen

3) Set dew-point temperature



Picture 4-15: Dehumidify Process Screen

4) Press  button, machine will start up.

Note: In this mode, regeneration temperature (dehumidifying temperature) will be adjusted according to the change of dew-point temperature to saving energy

4.1.4.5 Working Modes of Material Drying

A. Normal Drying Mode



Picture 4-16: Drying Process Screen

Note: In this mode, only drying temperature and air volume need to be set. Machine will dry the material under a set temperature and air volume.

B. Activate Recipe-Drying Mode

- 1) Press  button,

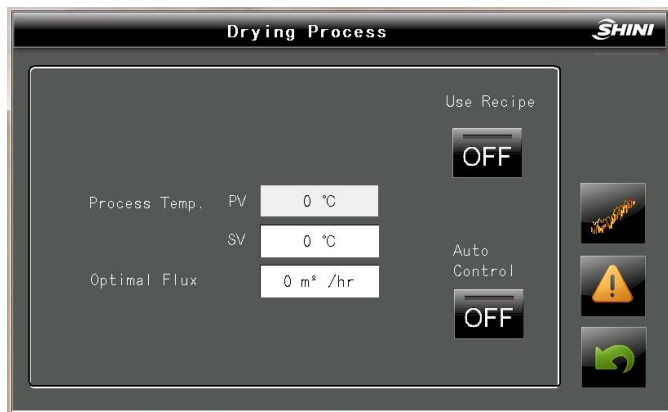

Picture 4-17: Drying Process Screen

- 2) Set Parameter of The Recipe

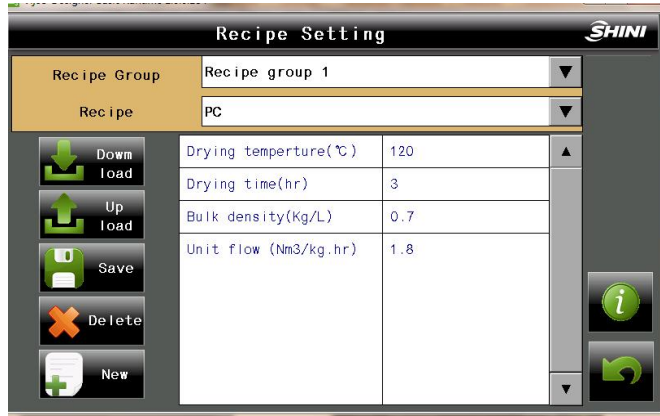

Picture 4-18: Recipe Setting Screen

3) Drying Process screen

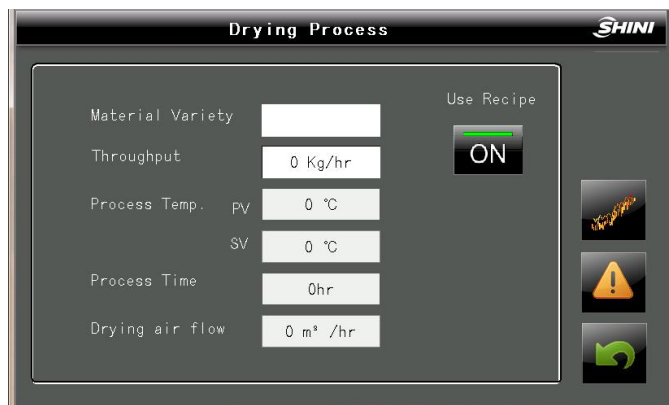

Picture 4-19: Drying Process Screen

Note: In this mode, drying air volume will change according to the throughput set in the recipe.

C. Using return-air's temperature control mode

- 1) Press  to make it run.



Picture 4-20: Drying Process Screen

Set drying temperature and return-air temperature of the material as picture above.

Note: In this mode, drying air volume will adjust according to return-air's temperature to achieve energy saved controlling.

4.1.4.6 Alarms Fault Records

Touch " Alarm Fault Records " button on the right of "Drying Process" screen or "Conveying Process" screen to enter into Alarm Fault Records screen. The screen is shown as below:



Picture 4-21: Alarm Fault Records

1. When alarm fault records cover more than displaying space, touch "Up" or "Down" keys to read more records.
2. According to the alarm information, the operator could get the troubleshooting information from the instruction book.

3. Press "EXIT" button to exit from this screen.

Table 4-2: Alarm Information List

Alert message	Range	Results	Possible causes
Anti-phase	SCD,SDD SD-H	System cannot operate, and the visible alarm is flickering.	Low voltage, anti-phase
Process blower overload.	SCD,SDD SD-H	Dehumidifier does not work and the visible alarm is flickering.	Incorrect motor overload setting, or motor burns out.
Regenerating blower overload.	SCD,SDD SD-H	Dehumidifier does not work and red alert light is flickering.	Incorrect motor overload setting, or motor burns out.
Conveying blower overload.	SCD	Material conveying stops and the visible alarm is flickering.	Incorrect motor overload setting, or motor burns out.
No.1 receiver suction problem	SCD	No.1 receiver stop suction function and the visible alarm is flickering.	Storage tank lacks material, suction probe problem, parameter wrongly setting, shut-off valve damaged.
No.2 receiver suction problem	SCD	No.2 receiver stop suction function and the visible alarm is flickering.	Drying hopper lacks material, suction box problem, parameter wrongly set, shut-off valve damaged.
No.3 receiver suction problem	SCD	No.3 receiver stop suction function and the visible alarm is flickering.	Drying hopper lacks material, suction box problem, parameter wrongly set, shut-off valve damaged
Process temperature overheat	SDD,SCD	Dehumidifier does not work and the visible alarm is flickering.	Temperature control parameter wrongly setup, touching pad is malfunction, process heating problem.
Regenerating temp.overheat	SCD,SDD SD-H	Alarm display on screen	1. Temperature control parameter set envi 2. Contactor fail 3. Thermocouple fail
Temp. overheat	SCD,SDD SD-H	Message display screen	No water supply or high water temperature.
Process temp. Thermople broken	SDD,SCD	Dehumidifier does not work and the visible alarm is flickering.	Thermocouple disconnected or bad contact.
Regenerating temp. Thermocouple broken	SCD,SDD SD-H	Dehumidifier does not work and the visible alarm is flickering.	Thermocouple disconnected or bad contact.
Rotor is not working	SCD,SDD SD-H	Dehumidifier stop and the visible alarm is flickering.	Rotor driving motor burnt, belt broken, micro switch fail, or incorrect rotor speed monitoring parameter setting.
PLC is not under operation mode	SCD,SDD SD-H	System stops.	PLC work mode is not in RUN mode.

Note: 1) Overload Relay reset: Open control box, press "RESET" button on the corresponding overload relay.

2) Rotor Failure Alarm reset: Turn off the Drying Switch and then turn it "ON" again.

3) Over Temperature Alarm reset: Turn off the Drying Switch and then turn it "ON" again after the temperature drops down.

5. Trouble-shooting

Troubles	Possible causes	Solutions
Main power indicator does not light after turn on main power switch.	1. Does not connect through power supply.	1. Connect through power supply.
	2. Main power switch breakdown.	2. Replace main power switch.
	3. Problems of electrical wires.	3. Check electrical wires.
	4. Fuse of control circuit melted.	4. Check electrical wires and replace fuse.
	5. Transformer problems.	5. Replace the transformer.
E-02 is shown at PV, buzzer sounds and machine stops.	1. Voltage of power supply is too low.	1. Check the power supply.
	2. Phase failure	2. Check the power supply.
	3. Phase frequency mistakes.	3. Exchange the connection of two of the electrical wires.
Overload alarm of blower lit up, buzzer sounds and machine stops.	1. Abnormal fluctuation of voltage.	1. Check power supply.
	2. Blower being stalled.	2. Check the blower.
	3. Failures of blower motor.	3. Check the motor.
	4. Setting current of overload relay (F1) is too low.	4. Set the current of overload relay 1.1 times of rated current of the motor. Reset overload relay: Press down the blue button on the relay after 1 minutes.
Heater overheat alarm is lit up, and the buzzer sounds and machine stops working.	1. Temperature setting mistakes.	1. Correctly set the parameters of temp.controller.
	2. Temp. measuring mistakes.	2. Replace thermocouple.
	3. Contactor failure: Process heater.	3. Replace the contactor.
E-04 is shown at PV, buzzer sounds and machine stops	1. Heater contactor seized up.	1. Check or replace the heater contactor.
	2. EGO parameter setting wrong.	2. Set EGO parameter correctly.
	3. EGO fault.	3. Replace EGO.
	4. Circuit fault.	4. Check circuit.
E-09 is shown at PV, buzzer sounds and machine stops	1. Problems of rotor motor.	1. Check or replace the motor.
	2. Rotor belt broken.	2. Replace the belt.
	3. Problems of electrical circuit.	3. Check the electrical circuit.
	4. Micro switch of the rotor failures.	4. Replace.
	5. Parameter mistakes of timer for control of rotor.	5. Reset the timer. (Set time should be bigger than rotor rotating time in one turn and plus 1 minute.)
Abnormal temp. fluctuations.	1. Too short of time since start of the machine.	1. Wait for a while.
	2. Improper parameters for temp. controller.	2. Check the parameters of temp. Controller.
Heater temp. can not rise up.	1. Temp. Setting is too high.	1. Set heater temp. under 180℃.
	2. Contactor of heater is bad.	2. Replace contactor.
	3. Heater is damaged.	3. Replace pipe heater.
	4. Problems of thermocouple.	4. Replace thermocouple.
	5. Parameter of temp. controller is set to STOP.	5. Set temp. controller under working mode.
	6. Temp. controller output problems.	6. Replace or repair temp. controller.
Breaker tripping off when connects with power supply.	1. Short circuits of main circuit.	1. Check the circuit.
	2. Short circuit of transformer.	2. Replace the breaker.
	3. Problems of breaker.	3. Replace the breaker.

Troubles	Possible causes	Solutions
Circuit breaker trips right after system switch on.	1. Blower short circuits	4. Please check the blower
	2. Problems of the breaker.	5. Replace the breaker.

6. Maintenance and Repair

Check the accuracy of the temperature controller.
Period: Daily.

Check whether the dew point is normal. (when dew-point monitor is installed on the machine) Period: Daily.

Check whether the contactor is normal.
Period: Weekly.

Replace the PC board.
Period: every 3 years.

Replace the no fuse switch. Period: when damage occurs.

Check whether the air pipeline.
Period: Weekly.

The maintenance and repair of honeycomb
a. make sure the gear motor and the synchromesh gear have no damage.
b. clean the honeycomb.
Period: Semiyearly.

Replace the heaters when breaking down.

Check the over temperature protector (stop heating when heater temperature reaches the set value of over temperature protector.)

Clean the cooler.
Period: Semiyearly.

Clean the dust-proof screen. Period: Monthly

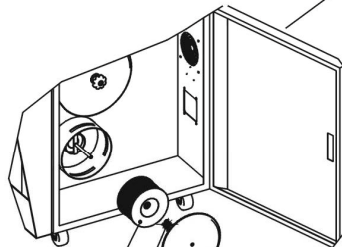

Filter
Butterfly nut
Filtering barrel lid
Star nut

Filter cleaning
Period: Daily.

Cleaning steps: unscrew the plum flower nut, demount the filter cover, unscrew the butterfly nut and take out the filter. Use compressed air to blow off the dust from inside out. Reinstall it after cleaning.

Notice: do not fall any impurities into the filter.

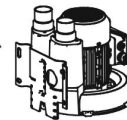

Clean the Blower

- a. Blow off the dust inside and outside the blower. Period: Monthly.
- b. Replace the bearing, grease seal and muffler according to the operating environment.
- c. Replace the blades, shell and metal mesh according to the operating environment.

6.1 The Useful Life of the Key Parts of the Product

Table 6-1: The useful life of the key parts of the product

Name of the parts	Useful life
Blower	Above 5 years
Process heater	Above 1 year
Regen. heater	Above 1 year
Contactora	Above 2000,000 act
Honeycomb	5 years
Filter	1 year

6.2 Filter

Please periodically clean the dust on the air filters, once per week.

Cleaning steps:

- 1) Take out the air filter carefully.
- 2) Blow off the dust on the air filter screen and the cover with pressure air.
- 3) Wipe off the barrel wall of air filter with dishcloth.
- 4) After cleaning, place all parts in reversed order carefully.
- 5) Please ensure that the filter is well seal with metal frame.



Picture 6-1: Filter

Note: Don't let foreign object enter into the barrel, when taking out the air filter.

6.3 Honeycomb-rotor

6.3.1 What is Honeycomb-rotor

The main body of the honeycomb-rotor is a honeycomb, made by ceramic fibre and organic additives, sintered under high temperature with molecular sieve and silica gel, to be strongly bonded together and form a solid and hard surface. Not like common molecular sieve, which will produce dusts and fines to pollute raw materials when aging or become saturated requiring regular replacement, the moisture of return air is quickly absorbed by numerous tunnels before coming out of the rotor to form low dew-point air. At the same time, regenerating blower takes dry air into the honeycomb-rotor from an opposite direction to regenerate the rotor.



Picture 6-2: Honeycomb Rotor

6.3.2 Installation of the Rotor

- 1) The upper and lower lid of honey-comb should install Teflon gasket (Fig. 1).
- 2) Use 4 screws to fix the rotor base on the machine frame firmly, and then install the shaft accordingly (Fig. 2).
- 3) Install the gearmotor and transmission gear (Fig. 4).
- 4) Install and fix the main support screws (Fig. 3).
- 5) Fit the transmission belt in proper position (Fig. 6).
- 6) Install the honeycomb-rotor (Fig. 9) and transmission belt (Fig. 12).
- 7) Fix the rotor top cover (Fig. 8).
- 8) Fit all springs and tighten the screws (Fig. 7).

- 9) Install both the transmission belt (Fig. 13) and belt tension regulator (Fig. 14).
- 10) Install micro-switch and fixed board firmly (Fig. 10).



Picture 6-3: Installation of The Rotor

6.3.3 Honeycomb Rotor Cleaning Steps

1. Use a vacuum-cleaner with brush to suck up the dust on rotor surface.
2. Blow off the dust in the rotor channels with compressed air.
3. If there is dirt sticking to the channel walls inside the rotor, cleaning steps are as follows:
 - a. Saturate the rotor by blowing humid air (higher than 60%RH) through the rotor without having regeneration circuit on. This can be done by just turning the regeneration heater off and still have the process blower running if process air has high humidity. If the process air is too dry try to put a humidifier in the air stream. Do this for one hour.
 - b. According to the character of the dirt, sink the rotor into water with cleaning agent in it (PH value 3~2 liquid is applied to silica gel, PH value 7~10 applied

to molecular valve). Greasy dirt should be put into a detergent solution with xylene. 15 minutes cleaning is suggested.

- c. Take the rotor out of the liquid and let it rest with the channels vertically for 5 minutes so the liquid can run out.
- d. Blow off the residual liquid in the channels with compressed air.
- e. Put the rotor back into the dehumidifier and run the unit with regeneration circuit (the regeneration temperature between 50 °C and 60 °C) on for at least one hour.



Note!

1. Note that in the dry air and wet air outlets, there will be high concentrations liquid out for some time. If a solvent has been used, there will be a residual smell for several days.
2. For some dirt which is greasy and sticky in the rotor, 100% elimination is impossible. The only one thing you can do is to replace the rotor for the cleaned rotor performance can only be recovered partly.

6.4 EGO



The EGO value has been setting before out factory, Don't modify it.



	Default Value
Drying	200 °C
Regenerating	200 °C

Picture 6-4: EGO

6.5 Cooler Clear Step

- 1) Disassemble the cooler's pipe and screw, and remove the cooler out of the chiller.
- 2) Release the fixed screw on the upper and lower cover of cooler and disassemble the cover.
- 3) Use brushes, compressed air or low pressure water to clean the dust and sundries on the cooler fan and copper pipe. Notes: water residue on the

cooler fan and copper pipe should be dried with compressed air.

- 4) Make the cooler's upper and lower cover junction clean enough and smear the silica gel then fixed the covers with screws.
- 5) Put the cooler on the air at least 4 hours to make the silica gel drying enough then fix the cooler on the chiller and connect all pipes.

6.6 Dewpoint Monitor(Optional)

6.6.1 Installation for Dewpoint Monitor

- 1) Cut off the film on control panel. Slightly cut it with the blade as there reserved with the holes.



Picture 6-5: Hole Site

- 2) Check if there are complete parts for dewpoint monitor including:
Dew-point monitor
Dew-point transmitter assembly (dew-point detector, detection cable, washer and installation guide)
Copper joint, installation seat for dew-point monitor



Picture 6-6: Parts of Dew-point Monitor

- 3) Remove the dew-point detector assembly from the machine, and mount it to another $\Phi 28$ hole on the controller. Install a dew-point monitor base on original hole, and mount two Teflon pipe connectors on the base. Via the copper pipe, one connector connects to the honeycomb and another connects to the dew-point detector assembly.



Picture 6-7: Copper Joint Assembly of Original Machine

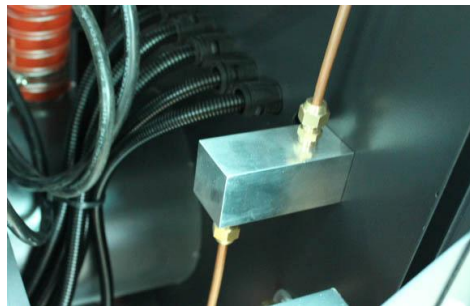

Picture 6-8: Installation Seat

- 4) Install dew-point transmitter assembly to copper joint.

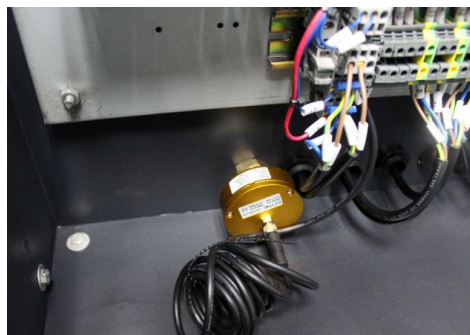

Picture 6-9: Installation for Transmitter

- 5) Insert the dew-point monitor into the hole on the panel and fasten it.

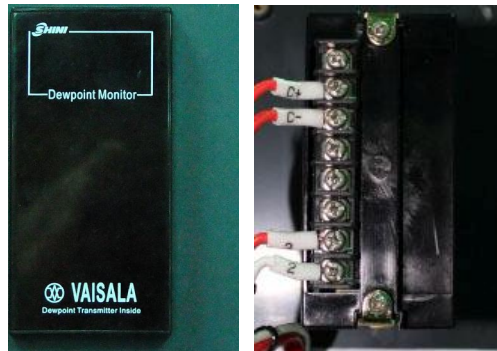

Picture 6-10: Connection of Signal Wire

- 6) Connect signal wires of the transmitter and power lines of dew-point monitor with the according terminals.

Connect contact No.1 and No.2 with power, supply is 220VAC.

Contact No.3, No.4 and No.5 are idle.

Connect contact No.6 and No.7 with the signal of transmitter. (C- Connects contact No.6, C+ connects contact No.7)

Dew-point transducer wiring (white connect to C-, blue connect to C+)

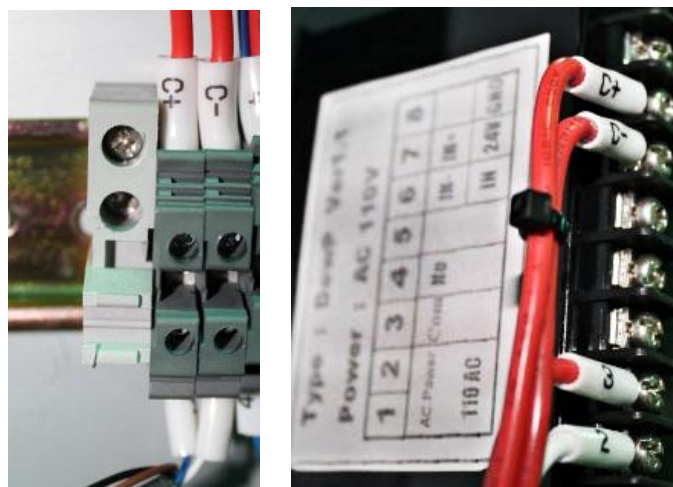

Picture 6-11: Connection of Dew-point Monitor

6.6.2 Dew-point monitor setting

1. Common mode functional setting (adjust dew-point alarm setting value):
 - 1) Press “S” key to enter setting (after entering, the displayer flickers);
 - 2) Adjust dew-point alarm setting value, and press “U” and “D” to adjust the

value.

3) Press "E" and save setting value.

4) Press "S" to leave setting mode.

2. Special mode functional setting:

Enter this mode. Firstly hold "U" "D" for three secs. and enter (after enter special mode, it displays F-X in which X means that different number.);

Menu functions:

F-3: °C or °F in unit

F-5: it is +20°C when input 20 ampere

F-6: it's in min. temp. when signal input is 4 ampere. For example, if the measuring range of dew-point transmitter is -60~+20°C (this range always marks on the transmitter), therefore F-6 should be -60°C, F-5 should be +20°C.

F-7: the upper limit value (99-99)

F-8: the lower limit value (99-99)

6.7 Maintenance Schedule

6.7.1 General Machine Information

Model _____ SN _____ Manufacture date _____

Voltage _____ Φ _____ V Frequency _____ Hz Power _____ kW

6.7.2 Check After Installation

- Check that the conveying pipes are tightly locked.
- Check that the material clearance door is firmly closed.
- Check that the conveying pipes are correctly connected.
- Check if there are damages of honeycomb-rotor.

Electrical Installatio

- Voltage: _____ V _____ Hz
- Fuse melt current: 1 Phase _____ A 3 Phases _____ A
- Check the phase frequency of power supply.
- Check rotating direction of regenerating motor.
- Check rotating direction of conveying blower fans.

Check air supply of compressor

- Compressed air pressure _____ bar
- Air flow _____ L/nun
- Check if the compressed air purified or not.

6.7.3 Daily Checking

- Check the switch of the machine.
- Check auto start-up of the machine.
- Check the temperature controller.
- Clean the filter.
- Check whether overheat protection is normal.
- Check whether dew-point is normal.

6.7.4 Weekly Checking

- Check all the electrical wires.

- Check if there are loose electrical connections.
- Check and maintain compressed-air filter and regulator.
- Check solenoid valve.
- Check motor overload relay and anti-phase function.
- Check whether air pipe is shed, leaked and loose.

6.7.5 Monthly Checking

- Check if transmission belt is loose or not.
- Check the status of gear motor performance.
- Check if there is leakage in the rotor.

6.7.6 Half-yearly Checking

- Check if there are damages of conveying pipe.
- Check the pipe heater.
- Check regenerating/conveying blower and fans of the motor.
- Check whether honey-comb rotor belt is damaged.
- Clean the cooler.

6.7.7 Yearly Checking

- Check whether the contactor is normal ¹.

6.7.8 3 year Checking

- PC board renewal.
- No fuse breaker renewal.

Note: 1. Manufacturer laboratory data for AC contactor is two million times in life. we suggest service life for one million four hundred thousand times, if work eight hours per day, recommended replacing frequency is 1.5 years, if work day and night, replacement is suggested to be done every six months.