

版本 Ver.C

Mark	Before modification	Modified by	2	3	4	5	6	7	8	
	After modification	Modify date	20160816							
Designer	Proofread by	Checked by	Approved by	Version	D	Title				
						SDD-20U(40U)(80U)/40H-LC				
						Drawing NO.				
						SDD-20U(40U)(80U)/40H-LC-CE-400V-D-1				
						Standard	CE	Totally	7	Pages
						Scale		Page	1	
						Voltage		400V		
						Frequency		50HZ		

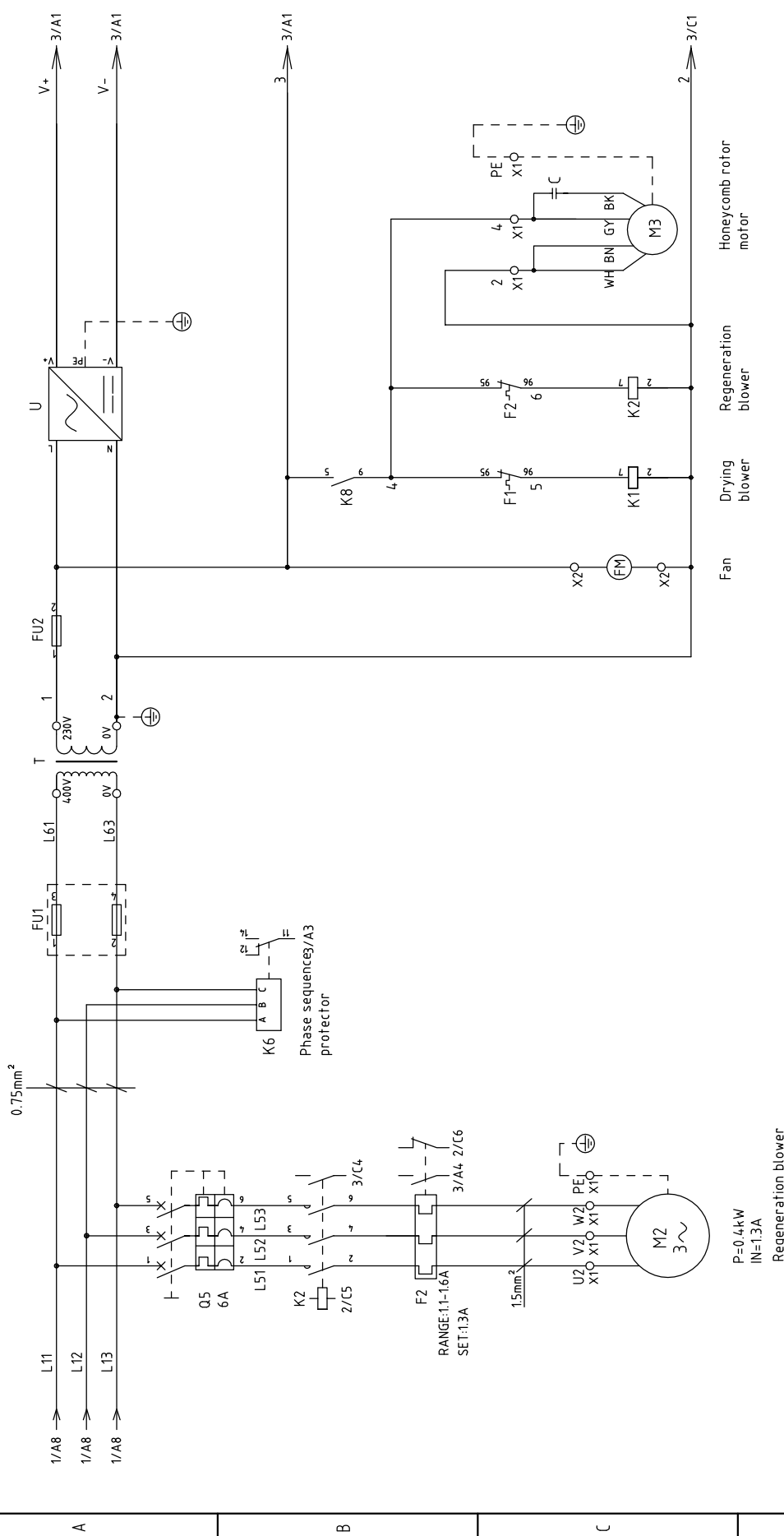

信易电热机械股份有限公司  
Shini Plastics Technologies, Inc.



版本 Ver.C

Mark	Before modification	Modified by	20160816	Date	Version	D	Title	SDD-20U(4.0U)(80U)/4.0H-LC		Drawing NO.	Scale	Page	2
	After modification	Checked by	20160816					Standard	CE			Totally	7
								SDD-20U(4.0U)(80U)/4.0H-LC-CE-400V-D-2		Voltage		400V	
								SHINI		Frequency		50HZ	
								信易電熱機械股份有限公司 Shini Plastics Technologies, Inc.					



信易電熱機械股份有限公司  
Shini Plastics Technologies, Inc.

Standard CE

Voltage 400V

Frequency 50HZ

Drawing NO.

SDD-20U(4.0U)(80U)/4.0H-LC-CE-400V-D-2

Version

D

Drawer

Designer

Proofread by

Checked by

Modify date

After modification

Modified by

20160816

Date

Approved by

20160816

Title

SDD-20U(4.0U)(80U)/4.0H-LC

Standard

CE

Voltage

400V

Frequency

50HZ

Page

2

Totally

7

Pages

2

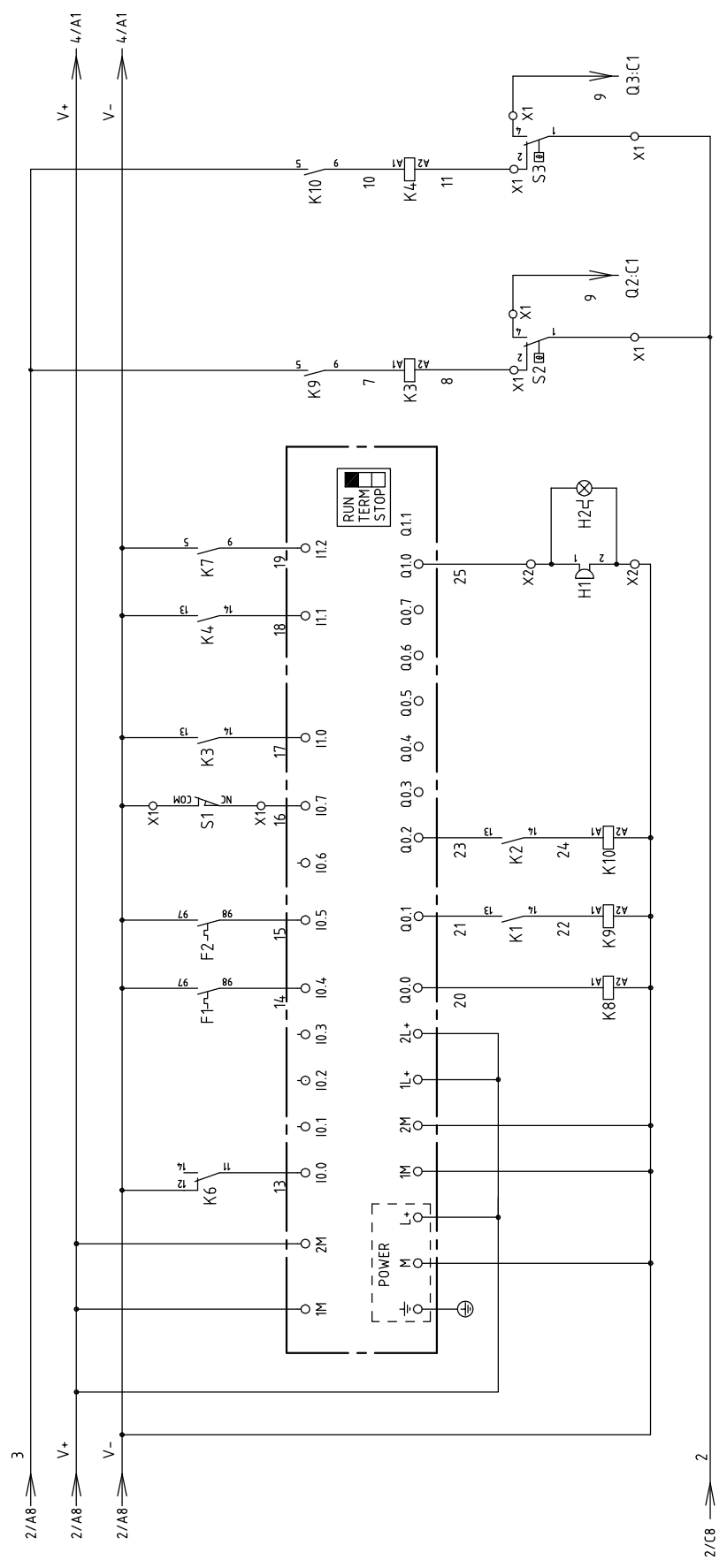

Blower relay    Drying heater relay    Regeneration heater relay    Alarm indicator    Buzzer    Drying heater    Regeneration heater

版本 Ver.C

Mark	Before modification	Modified by	Modify date	Version	D	Title	Drawing NO.		Scale	Page	
	After modification	Modified by	Modify date				Standard	Totally			
SDD-20U(40U)180U/40H-LC Control Circuit Diagram 1							SDD-20U(40U)180U/40H-LC-CE-400V-D-3	CE	3	7	
SHINI 信易電熱機械股份有限公司 Shini Plastics Technologies, Inc.							Voltage	400V	Frequency		50HZ
2/C8							2		3		8

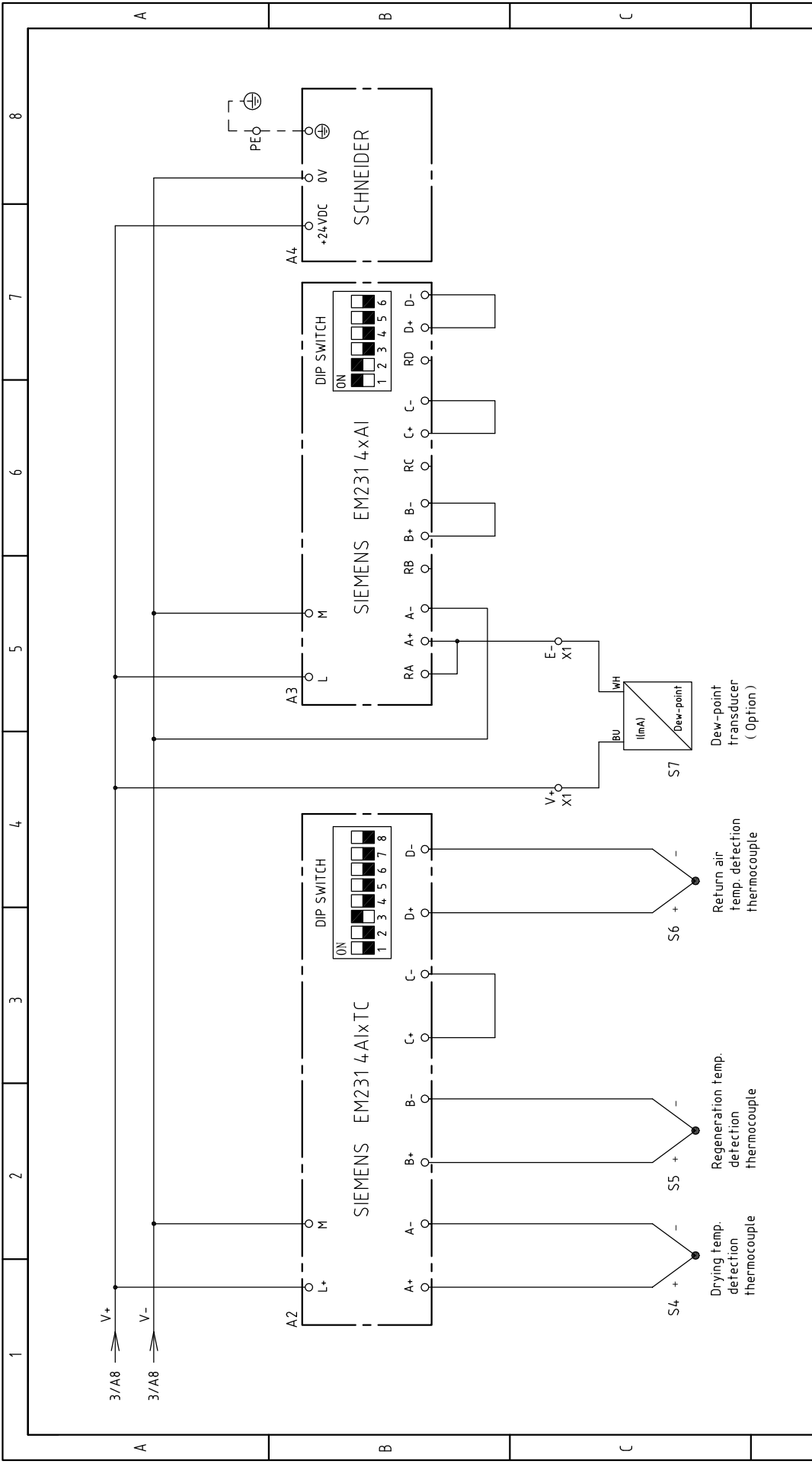

版本 Ver.C		D		Scale		Page 4	
		Version		Standard		Totally 7	
		Approved by		Voltage		400V	
		Date		Frequency		50HZ	
Title		Drawing NO.					
SDD-20U(40U)(80U)/4.0H-LC		SDD-20U(40U)(80U)/4.0H-LC-CE-400V-D-4					
Control Circuit Diagram 2							
SHINI		信易電熱機械股份有限公司					
SHINI		Shini Plastics Technologies, Inc.					
Mark		Before modification					
After modification		Modified by					
Modify date		Date					
20160816							
3		4					
2		3					
1		2					
1		3					
2		4					
3		5					
4		6					
5		7					
6		8					
7							
8							

1 2 3 4 5 6 7 8

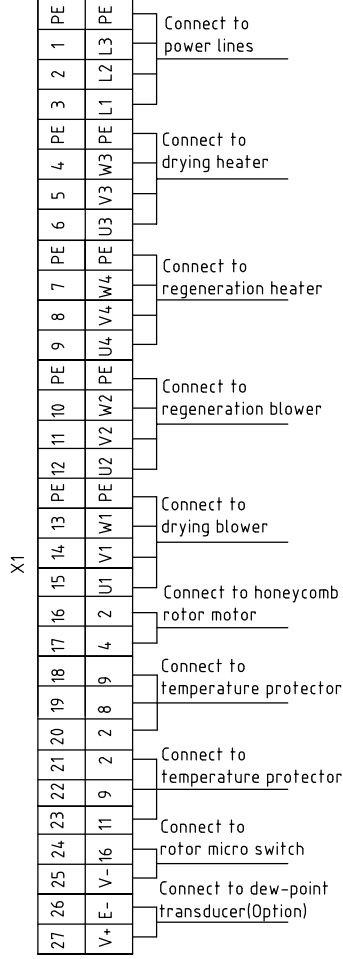
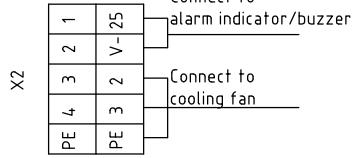
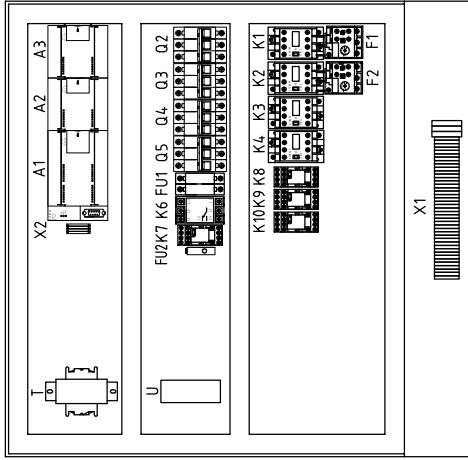
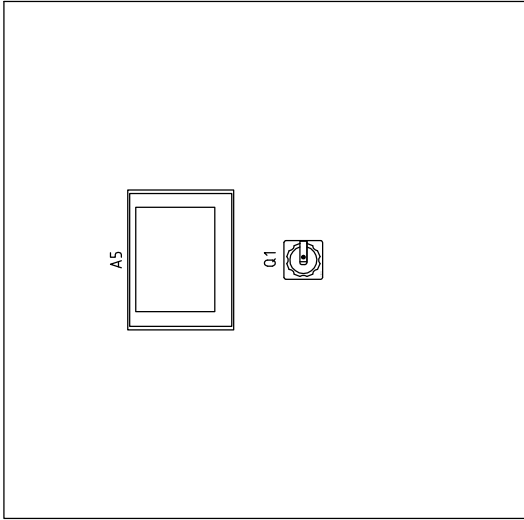

版本 Ver.C

Mark	Before modification	Modified by	Modify date	Checked by	Date	Approved by	Version	D	Title	SDD-20U(40U)(80U)/40H-LC Electrical Components Layout	Drawing NO.	SDD-20U(40U)(80U)/40H-LC-CE-400V-D-5	Scale	Page
													Standard	5
													Voltage	Totally
													Frequency	7
														Pages
														8

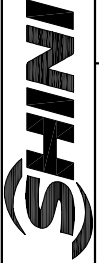

信易電熱機械股份有限公司  
Shini Plastics Technologies, Inc.

1	2		3	4	5	6	7	8
NO.	Symbol	Name	Manufacturer	Type	Specification	Number	Material number	Remark
1	Q1	Main switch	MOELLER	TO-2-1EA/SVB	16A	1	YE10021160000	
2	Q2 Q3	Circuit-breaker	TECO	BM-63C/3010S	10A	2	YE40301003000	
3		Excitation release	TECO	MX	220V 50/60Hz	2	YE40023560000	
4	Q4 Q5	Circuit-breaker	TECO	BM-63C/3006S	6A	2	YE40300603000	
5	K1	Contactor	SIEMENS	3RT6016-1AN21	220V 50/60Hz	1	YE00601621000	
6	K2	Contactor	SIEMENS	3RT6016-1AN21	220V 50/60Hz	1	YE00601621000	
7	K3	Contactor	SIEMENS	3RT6017-1AN21	220V 50/60Hz	1	YE00601721000	
8	K4	Contactor	SIEMENS	3RT6017-1AN21	220V 50/60Hz	1	YE00601721000	
9	K6	Phase relay	CHAOSHI	ABJ-10W	400V 50/60Hz	1	YE03103800000	
10	K7	Middle relay	WEIDMULLER	DRM270730LT	220V 50/60Hz	1	YE03270700000	
11	K8 K9 K10	Middle relay	WEIDMULLER	DRM270724LT	24V DC	3	YE03272400000	
12	F1	Thermo overload relay	SIEMENS	3RU6116-0EB0	0.28-0.4A	1	YE01161280000	
13	F2	Thermo overload relay	SIEMENS	3RU6116-1AB0	1.1-1.6A	1	YE011610000	
14	A1	PLC	SIEMENS	CPU224 DC/DC/DC	24VDC	1	YE81022400000	
15	A2	PLC Analog module	SIEMENS	EM231 4xTC	--	1	YE82023100100	
16	A3	PLC Analog module	SIEMENS	EM231 4xAI	--	1	YE82023100000	(2)
17	A4	Human-machine interface	SCHNEIDER	GX03501	24VDC	1	YE80350100100	
18	FU1	Fuse base	CHINT	RT18-32	2P	1	YE41032200000	
19	FU2	Fuse	CHINT	10x38 500V	2A	2	YE46002000100	
20	FU2	Fuse	YINDA	FS-10	2A	1	YE41001000000	
21	T	Transformer	--	--	IN=400V OUT=230V 500mA	1	YE70402300800	
22	U	DC power	MEAN WELL	NES-35-24	OUT=DC24V 1.5A	1	YE71352400100	
23	H1	Buzzer	HITPOINT	PK-27A	24VDC	1	YE84002700000	(1)
24	H2	Alarm indicator	SHINI	LED-3051	24VDC	1	YE83305100300	(1)
25	S1	Micro switch	TEND	LXW5-11G1	250V 5(4)A	1	YE14511100000	(1)
版本 Ver.C								
Notes: (1)Means it's not the material inside the control box. (2)Stands for optional.								
D			Drawer	Version	Title	Drawing NO.		Page
			Designer	D	SDD-20U(4.0U)(80U)/4.0H-LC	Standard	SDD-20U(4.0U)(80U)/4.0H-LC-CE-4.00V-D-6	6
			Proofread by	Approved by	Electrical Components list 1		CE	Totally 7
			Checked by	Date			Voltage	Pages
Mark	Before modification	After modification	Modified by	Modify date			Frequency	400V
				20160816			50Hz	
1	2	3	4	5	6	7	8	



信易電熱機械股份有限公司  
Shini Plastics Technologies, Inc.



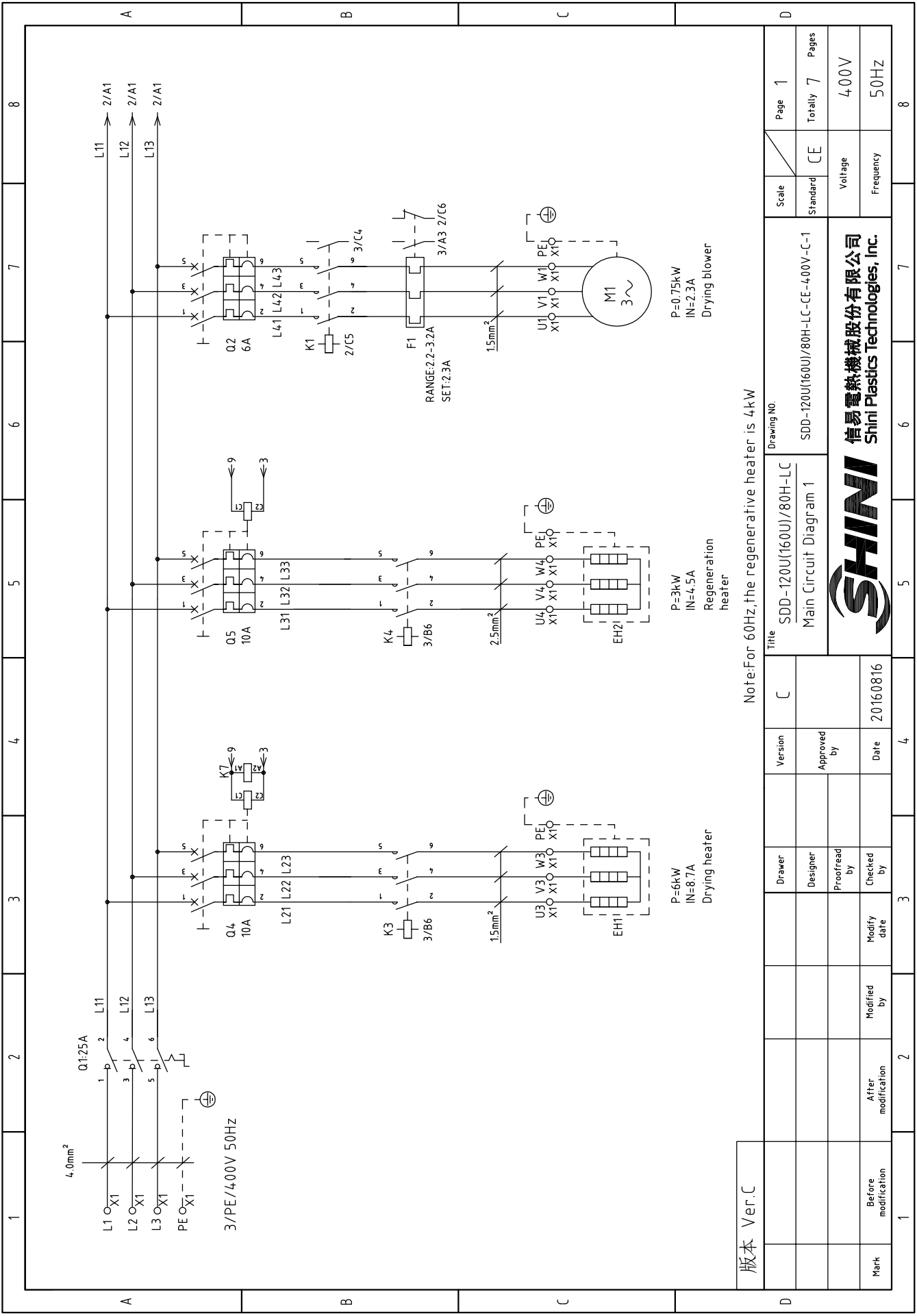

版本 Ver.C

Note: For 60Hz, the regenerative heater is 4kW

Mark	Before modification	Modified by	2	3	4	5	6	7	8
	After modification	Modified by	2	3	4	5	6	7	8
Checked by									
Proofread by									
Designer									
Drawer									
Version	C								
Title		SDD-120U(160U)/80H-LC							
Drawing NO.		SDD-120U(160U)/80H-LC-CE-400V-C-1							
Scale	Standard	CE	Page 1		Totally 7 Pages				
Voltage	400V								
Frequency	50HZ								





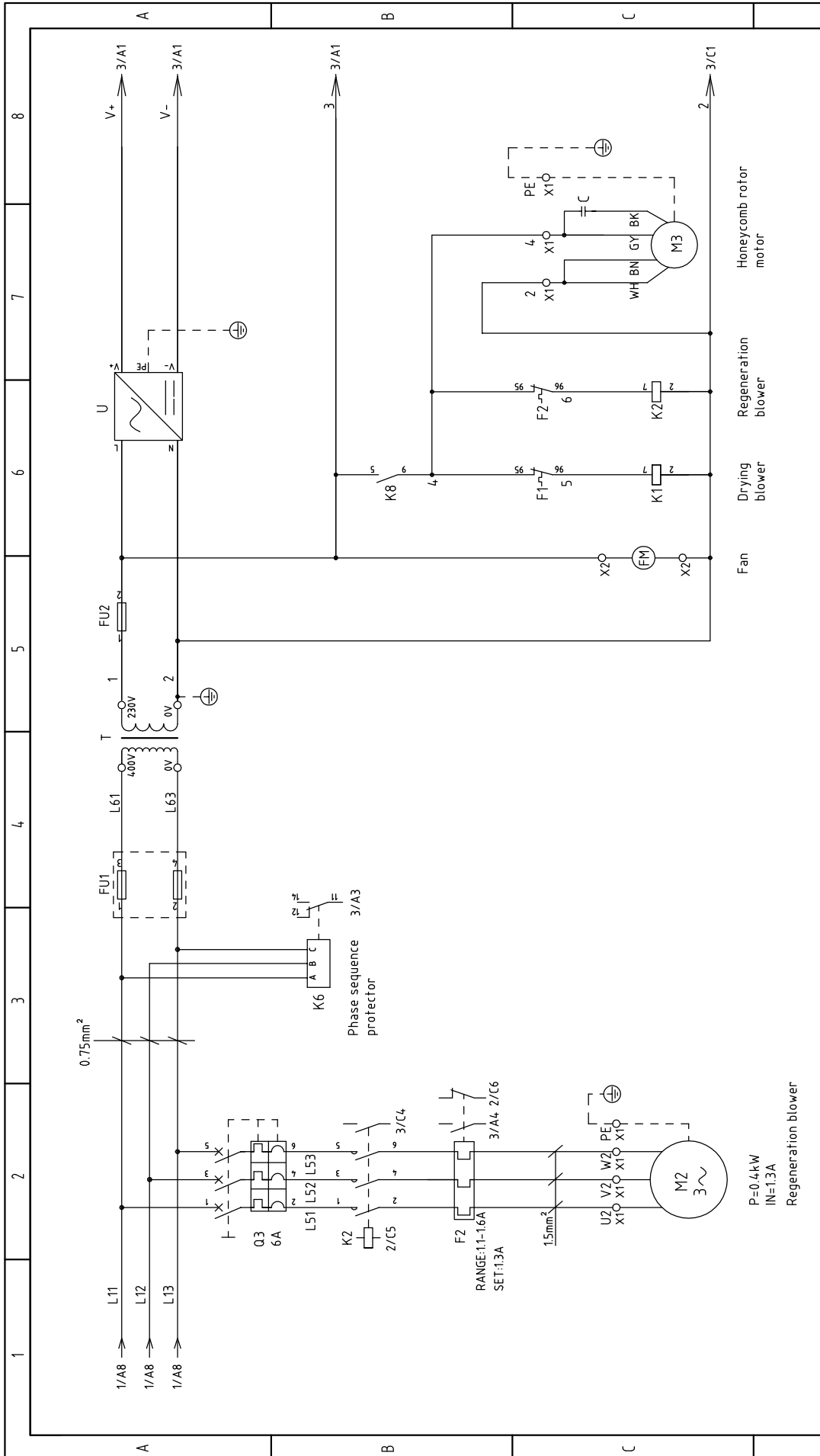

版本 Ver.C

Mark	Before modification	Modified by	2	3	4	5	6	7	8
	After modification	Modify date	20160816						
Drawer	Designer	Proofread by	Checked by						
	Version	Approved by	Date						
Title			SDD-120U(160U)/80H-LC						
Drawing NO.			SDD-120U(160U)/80H-LC-CE-400V-C-2						
Main Circuit Diagram 2									
Scale			CE						
Standard			Voltage						
Frequency			400V						
Page			2						
Totally			7						
Pages			50HZ						



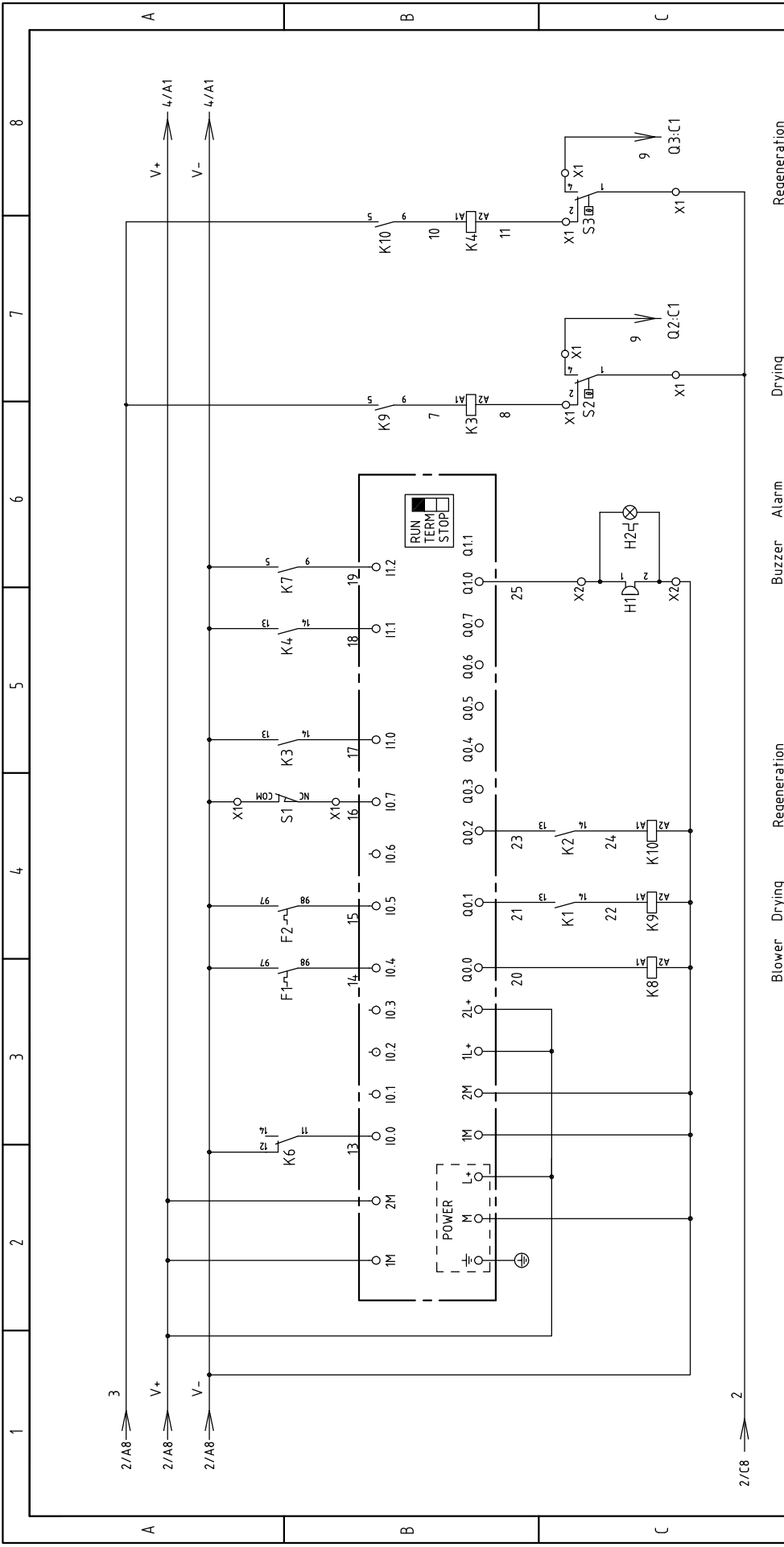

Mark	Before modification	Modified by	Modify date	2	3	4	5	6	7	8
Version	C									
Approved by										
Date	20160816									

Scale	Standard	CE	Page	3
Standard	Voltage	400V	Totally	7
Frequency	50HZ			

Version	C									
Approved by										
Date	20160816									

Mark	Before modification	Modified by	Modify date	2	3	4	5	6	7	8
Version	C									
Approved by										
Date	20160816									
Scale	Standard	CE	Page	3						
Standard	Voltage	400V	Totally	7						
Frequency	50HZ									

版本 Ver.C

SHINI  
信易電熱機械股份有限公司  
Shini Plastics Technologies, Inc.

Control Circuit Diagram 1  
SDD-120U(160U)/80H-LC  
SDD-120U(160U)/80H-LC-CE-400V-C-3

Blower relay  
Drying heater relay  
Regeneration heater relay  
Buzzer  
Alarm indicator  
Drying heater  
Regeneration heater

2/168  
V+  
V-  
4/A1  
4/A1  
2/C8

2/168  
V+  
V-  
4/A1  
4/A1  
2/C8

2/168  
V+  
V-  
4/A1  
4/A1  
2/C8

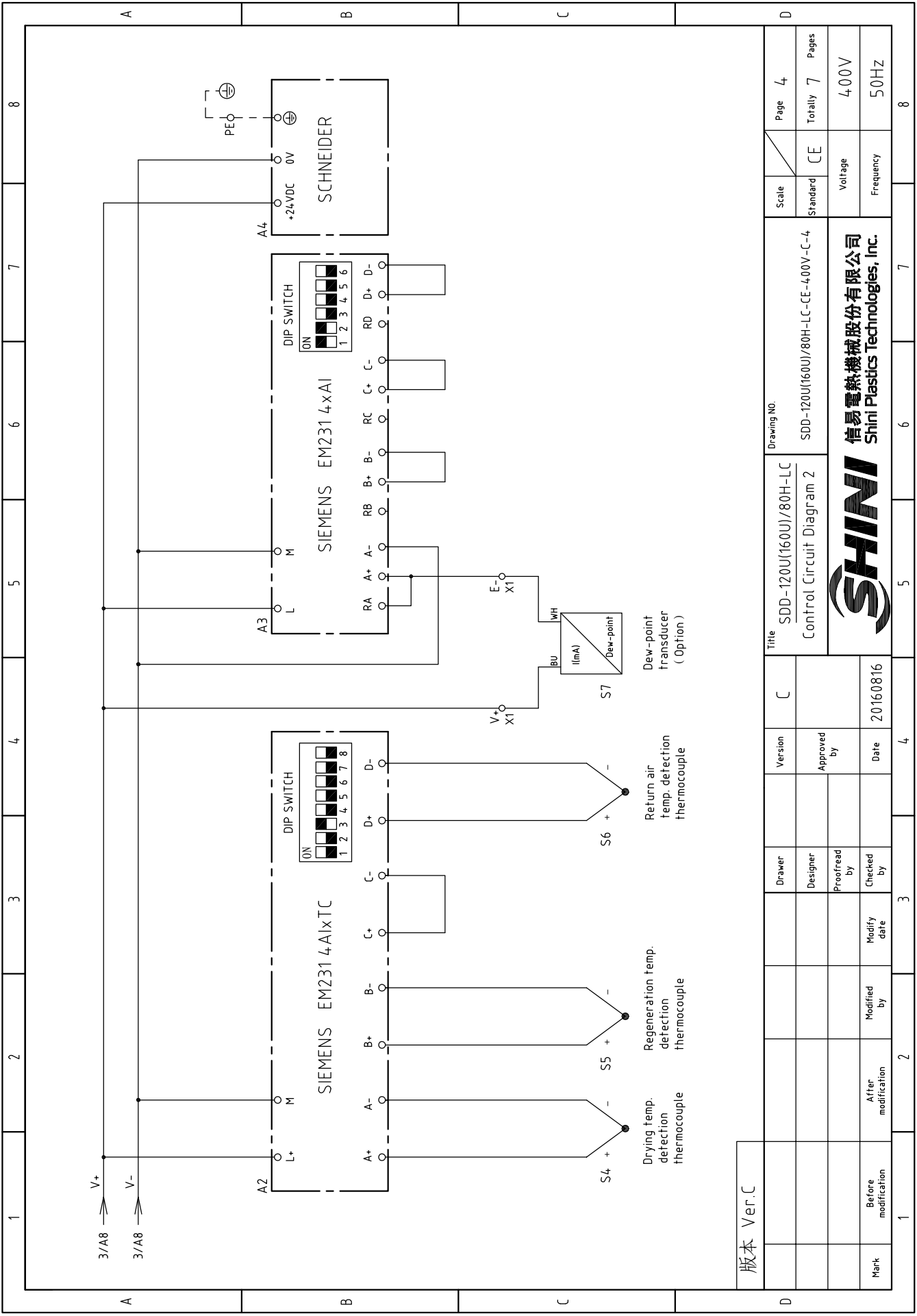

版本 Ver.C

Mark	Before modification	After modification	Modified by	Modify date	Checked by	Designer	Proofread by	Version	C	Approved by	Title		SDD-120U(160U)/80H-LC		Drawing NO.		SDD-120U(160U)/80H-LC-CE-400V-C-4		Scale	Standard	CE	Page	4	Totally	7	Pages	
												Control Circuit Diagram 2															
												SHINI		信易電熱機械股份有限公司		Shini Plastics Technologies, Inc.											

1 2 3 4 5 6 7 8

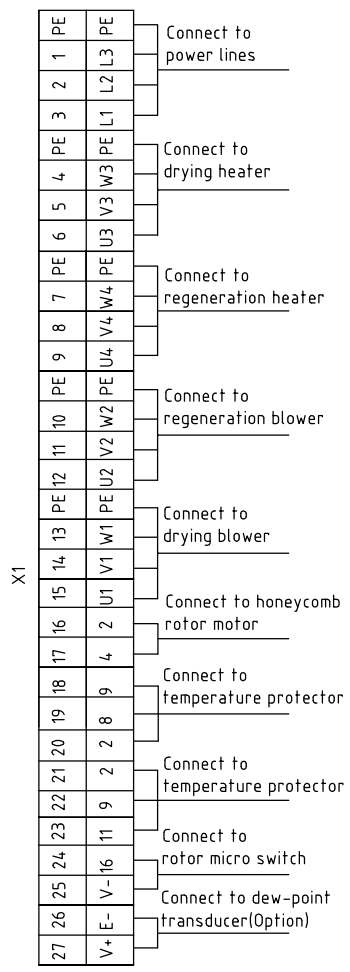
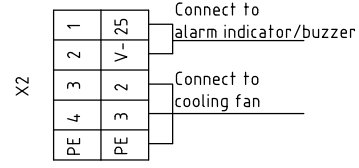
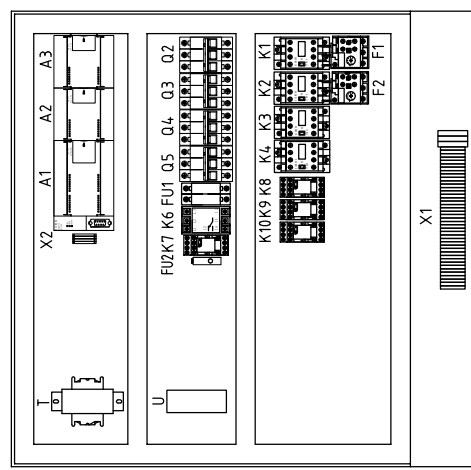
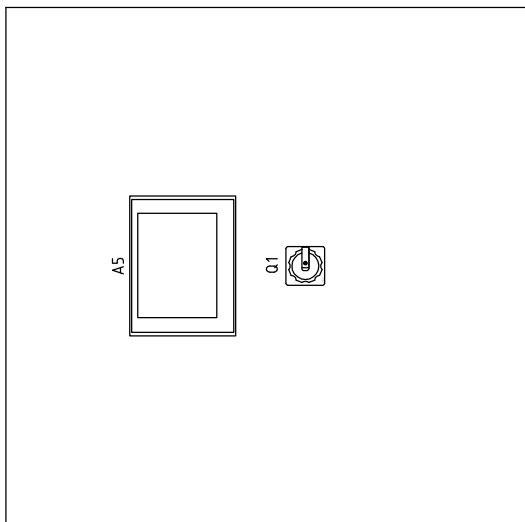

版本 Ver.C

Mark	Before modification	Modified by	2
		Modify date	3
		Checked by	4
		Date	20160816
		Approved by	4
		Version	C
		Title	SDD-120U(160U)/80H-LC
		Electrical Components Layout	
		Drawing NO.	SDD-120U(160U)/80H-LC-CE-400V-C-5
		Scale	Standard
		Page	5
		Totally	7
		Pages	
		Voltage	400V
		Frequency	50HZ



1 2 3 4 5 6 7 8

1	2		3	4	5	6	7	8
NO.	Symbol	Name	Manufacturer	Type	Specification	Number	Material number	Remark
1	Q1	Main switch	MOELLER	P1-25/EA/SVB	25A	1	YE10125250000	
2	Q2 Q3	Circuit-breaker	TECO	BM-63C 3P	10A	2	YE40301003000	
3		Excitation release	CHINT	MX	220V 50/60Hz	2	YE40023560000	
4	Q4 Q5	Circuit-breaker	TECO	BM-63C 3P	6A	2	YE40300603000	
5	K1	Contactor	SIEMENS	3RT6016-1AN21	220V 50/60Hz	1	YE00601621000	
6	K2	Contactor	SIEMENS	3RT6016-1AN21	220V 50/60Hz	1	YE00601621000	
7	K3	Contactor	SIEMENS	3RT6018-1AN21	220V 50/60Hz	1	YE00601821000	
8	K4	Contactor	SIEMENS	3RT6017-1AN21	220V 50/60Hz	1	YE00601721000	
9	K6	Phase relay	CHAOSHI	ABJ-10W	400V 50/60Hz	1	YE03103800000	
10	K7	Middle relay	WEIDMULLER	DRM270730LT	220V 50/60Hz	1	YE03270700000	
11	K8 K9 K10	Middle relay	WEIDMULLER	DRM270724LT	24V DC	3	YE03272400000	
12	F1	Thermo overload relay	SIEMENS	3RU6116-1DB0	2.2-3.2A	1	YE01160220000	
13	F2	Thermo overload relay	SIEMENS	3RU6116-1AB0	1.1-1.6A	1	YE01160110000	
14	A1	PLC	SIEMENS	CPU224 DC/DC/DC	24VDC	1	YE81022400000	
15	A2	PLC Analog module	SIEMENS	EM231 4xTC	--	1	YE82023100100	
16	A3	PLC Analog module	SIEMENS	EM231 4xAI	--	1	YE82023100000	(2)
17	A4	Human-machine interface	SCHNEIDER	GX03501	24VDC	1	YE80350100100	
18	FU1	Fuse base	CHINT	RT18-32	2P	1	YE41032200000	
19	FU2	Fuse	CHINT	10x38 500V	2A	2	YE46002000100	
20	FU2	Fuse	YINDA	FS-10	2A	1	YE41001000000	
21	T	Transformer	--	--	IN=400V OUT=230V 500mA	1	YE70402300800	
22	U	DC power	MEAN WELL	NES-35-24	OUT=DC24V 1.5A	1	YE71352400100	
23	H1	Buzzer	HITPOINT	PK-27A	24VDC	1	YE84002700000	(1)
24	H2	Alarm indicator	SHINI	LED-3051	24VDC	1	YE83305100300	(1)
25	S1	Micro switch	TEND	LXW5-11G1	250V 5(4)A	1	YE14511100000	(1)
版本 Ver.C								
Notes: (1)Means it's not the material inside the control box. (2)Stands for optional.								
D			Title	SDD-120U(160U)/80H-LC	Drawing NO.	SDD-120U(160U)/80H-LC-CE-400V-C-6	Scale	Page 6
			Version	C	Electrical Components list 1	Standard	CE	Totally 7 Pages
Mark			Designer	Approved by	SHINI	Voltage	400V	
			Proofread by	Date	20160816	Frequency	50Hz	
			Checked by					
			Modified by	Modify date				
			After modification					
			Before modification					
1	2	3	4	5	6	7	8	



信易电热机械股份有限公司  
Shini Plastics Technologies, Inc.



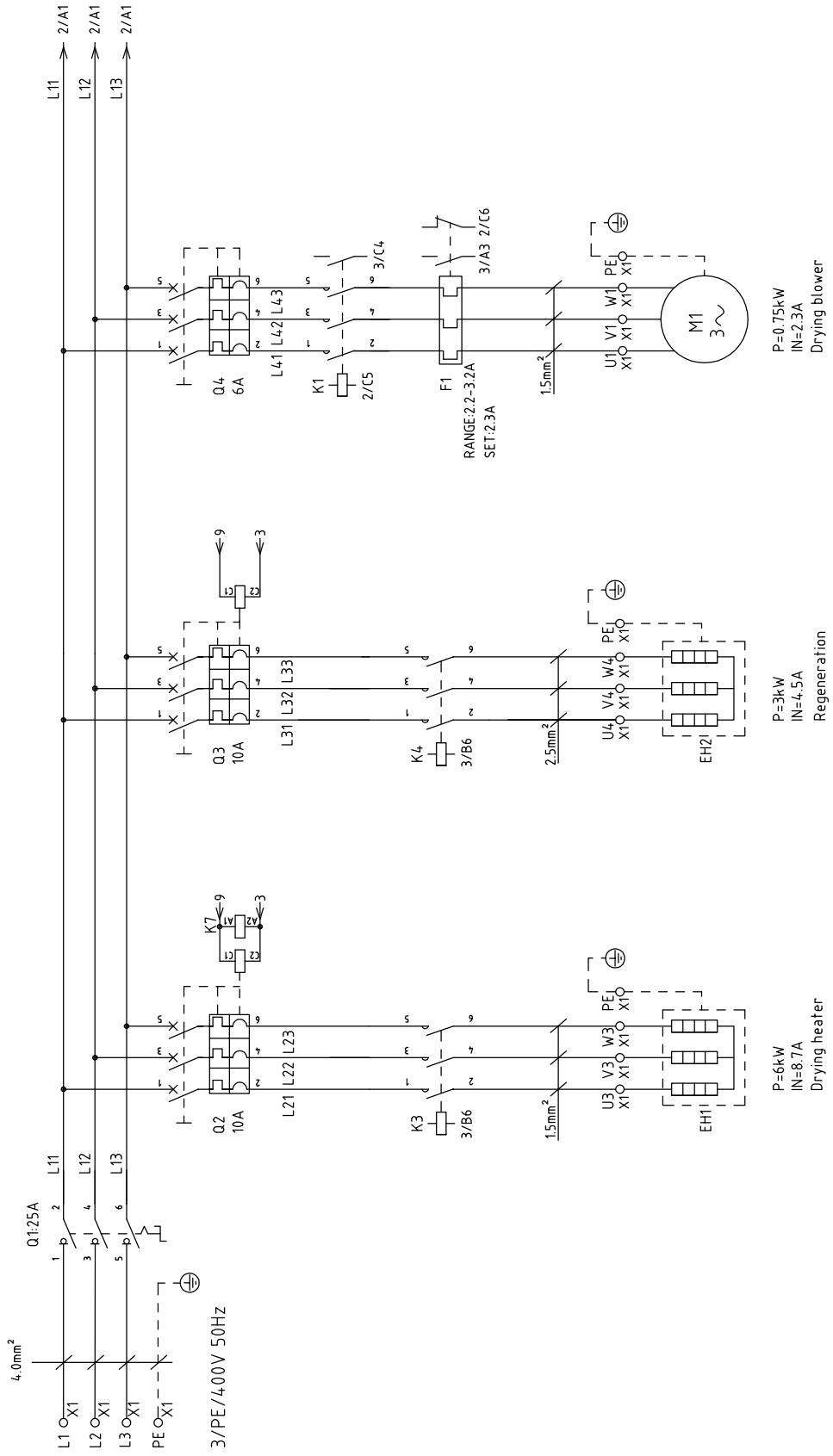

版本 Ver.C

Note: For 60Hz, the regenerative heater is 4kW

P=6kW  
IN=8.7A  
Drying heater

P=3kW  
IN=4.5A  
Regeneration heater

P=0.75kW  
IN=2.3A  
Drying blower

Mark	Before modification	Modified by	Modify date	Version	C	Title	Drawing NO.		Scale	Page 1	
	After modification	Modified by	Date				SDD-160U(230U)/120H-LC				Standard
							SDD-160U(230U)/120H-LC-CE-400V-C-1		CE	Totally 7	
							SHINI		Voltage		400V
							信易電熱機械股份有限公司 Shini Plastics Technologies, Inc.		Frequency		50Hz
											8

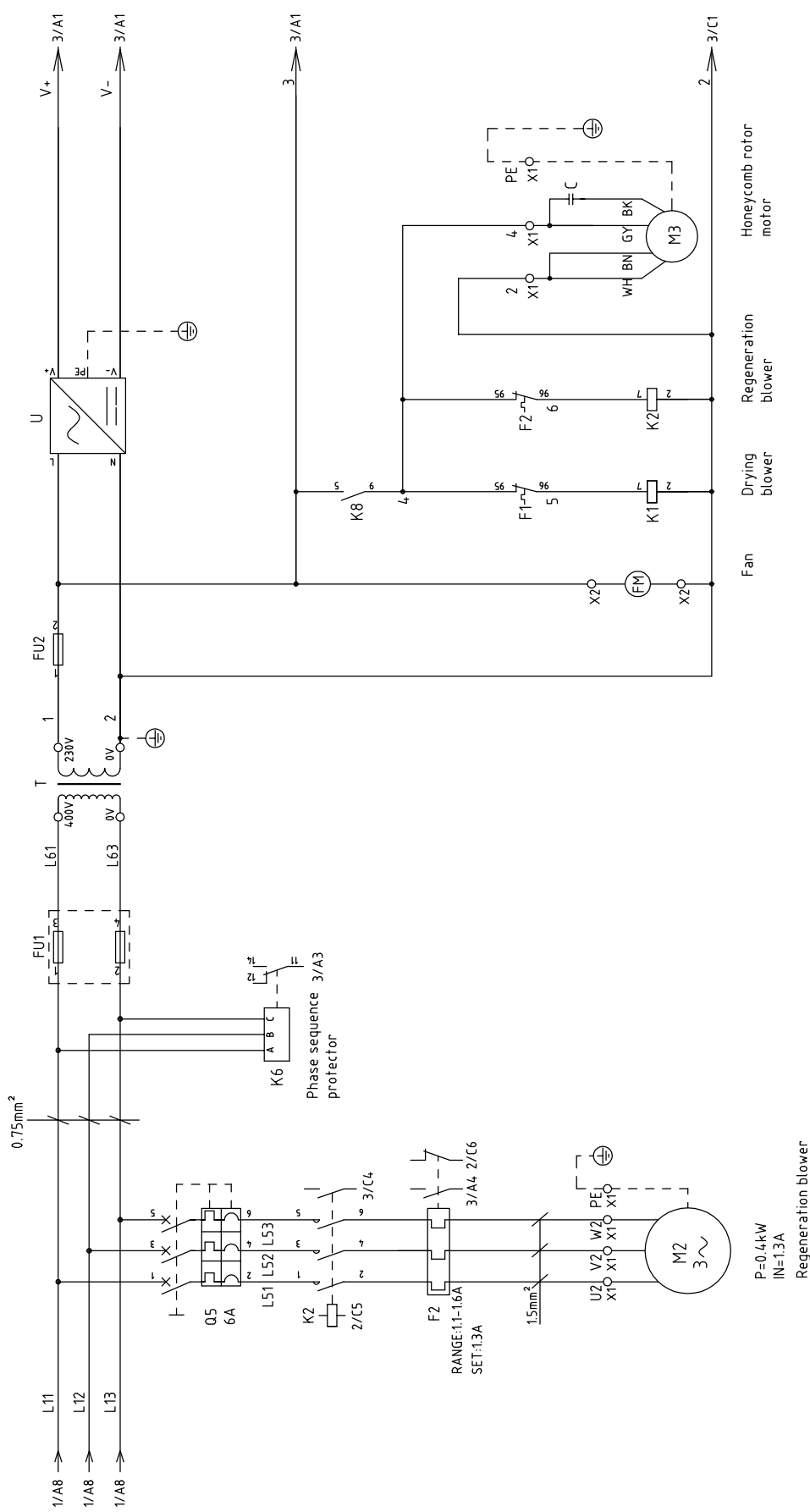

版本 Ver.C

Mark	Before modification	Date	20160816	Version	C	Title	SDD-160U(230U)/120H-LC		Scale	Page	2
	After modification						Modified by	Standard		CE	Totally
Main Circuit Diagram 2							SDD-160U(230U)/120H-LC-CE-400V-C-2		Voltage		400V
SHINI							信易電熱機械股份有限公司 Shini Plastics Technologies, Inc.		Frequency		50Hz
Drawing NO.							SDD-160U(230U)/120H-LC		Standard		CE
版本 Ver.C							SDD-160U(230U)/120H-LC		Voltage		400V
版本 Ver.C							SDD-160U(230U)/120H-LC		Frequency		50Hz
版本 Ver.C							SDD-160U(230U)/120H-LC		Standard		CE
版本 Ver.C							SDD-160U(230U)/120H-LC		Voltage		400V
版本 Ver.C							SDD-160U(230U)/120H-LC		Frequency		50Hz



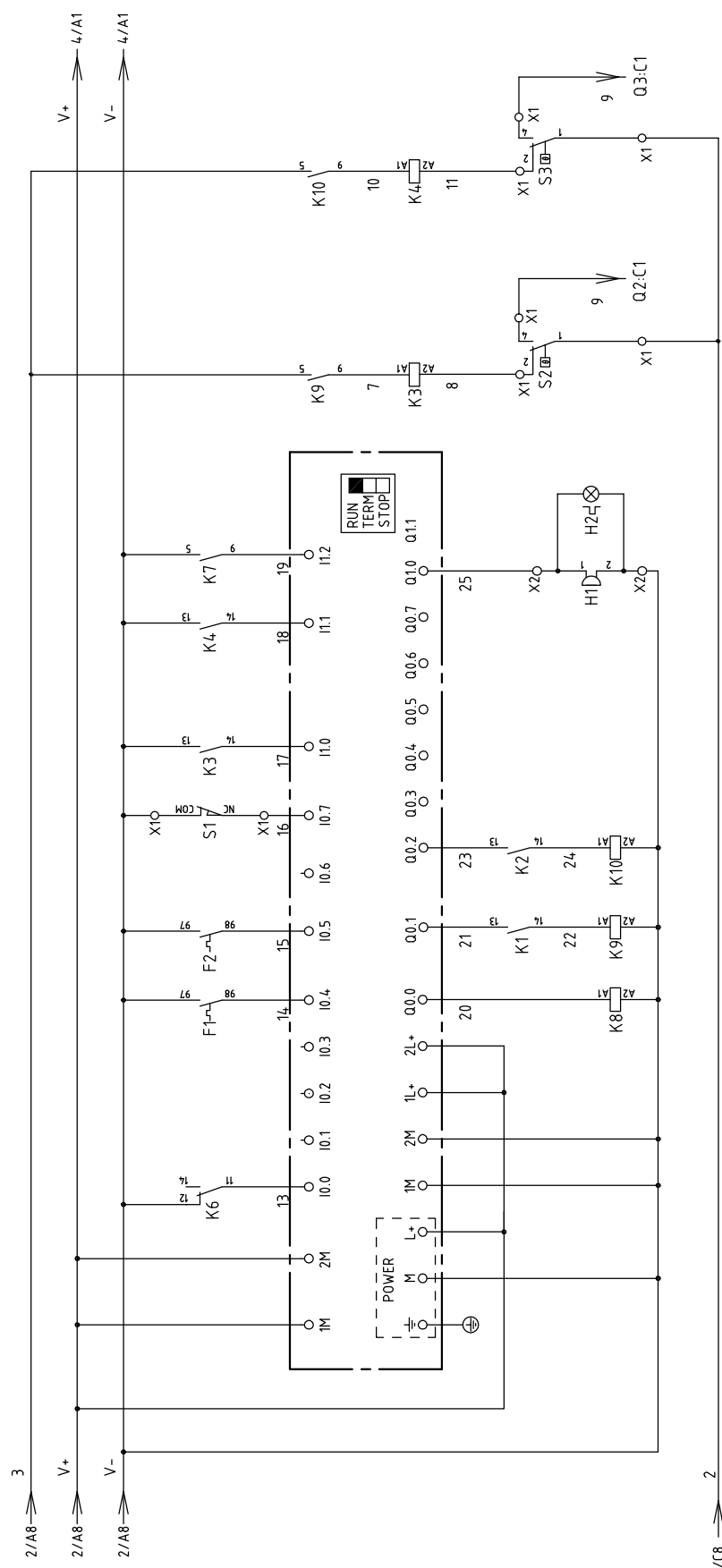

Blower relay    Drying heater relay    Regeneration heater relay    Buzzer    Alarm indicator    Drying heater    Regeneration heater

版本 Ver.C

Title		SDD-160U(230U)/120H-LC		Drawing NO.		SDD-160U(230U)/120H-LC-CE-400V-C-3		Scale		Page 3	
Control Circuit Diagram 1		Version		C		Standard		CE		Totally 7 Pages	
SHINI		Designer		Approved by		Voltage		400V		Frequency	
信易電熱機械股份有限公司 Shini Plastics Technologies, Inc.		Proofread by		Date		Frequency		50HZ		8	
Mark		Before modification		Modified by		Modify date		2		1	
Date		20160816		4		3		2		1	



1 2 3 4 5 6 7 8

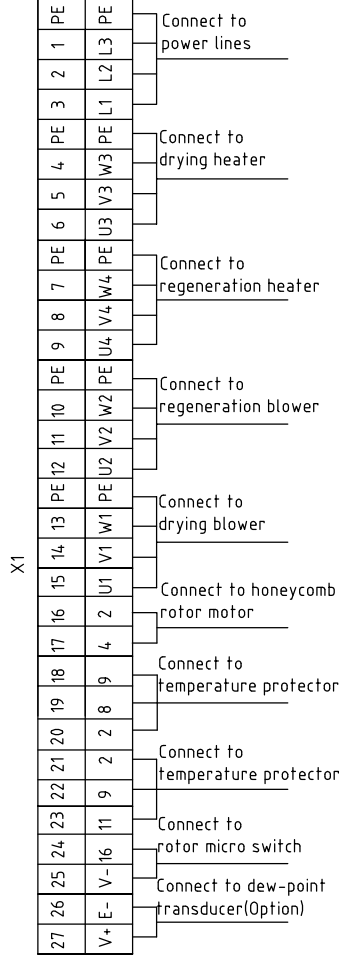
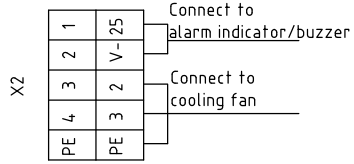
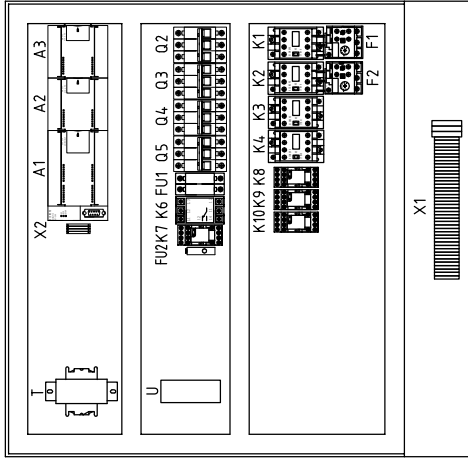
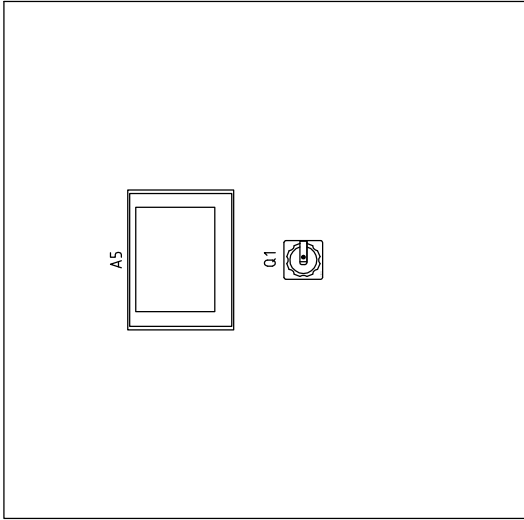

版本 Ver.C

Mark	Before modification	Modified by	Modify date	Version	C	Title	SDD-160U(230U)/120H-LC Electrical Components Layout	Drawing NO.	SDD-160U(230U)/120H-LC-CE-400V-C-5	Scale	Page
										Standard	5
										Voltage	Totally
										400V	7
										Frequency	Pages
										50HZ	8

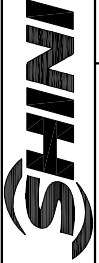

信易電熱機械股份有限公司  
Shini Plastics Technologies, Inc.

1	2		3	4	5	6	7	8
NO.	Symbol	Name	Manufacturer	Type	Specification	Number	Material number	Remark
1	Q1	Main switch	MOELLER	P1-25/EA/SVB	25A	1	YE10125250000	
2	Q2 Q3	Circuit-breaker	TECO	BM-63C 3P	10A	2	YE40301003000	
3		Excitation release	CHINT	MX	220V 50/60Hz	2	YE40023560000	
4	Q4 Q5	Circuit-breaker	TECO	BM-63C 3P	6A	2	YE40300603000	
5	K1	Contactor	SIEMENS	3RT6016-1AN21	220V 50/60Hz	1	YE00601621000	
6	K2	Contactor	SIEMENS	3RT6016-1AN21	220V 50/60Hz	1	YE00601621000	
7	K3	Contactor	SIEMENS	3RT6018-1AN21	220V 50/60Hz	1	YE00601821000	
8	K4	Contactor	SIEMENS	3RT6017-1AN21	220V 50/60Hz	1	YE00601721000	
9	K6	Phase relay	CHAOSHI	ABJ-10W	400V 50/60Hz	1	YE03103800000	
10	K7	Middle relay	WEIDMULLER	DRM270730LT	220V 50/60Hz	1	YE03270700000	
11	K8 K9 K10	Middle relay	WEIDMULLER	DRM270724LT	24V DC	3	YE03272400000	
12	F1	Thermo overload relay	SIEMENS	3RU6116-1DB0	2.2-3.2A	1	YE01160220000	
13	F2	Thermo overload relay	SIEMENS	3RU6116-1AB0	1.1-1.6A	1	YE01160110000	
14	A1	PLC	SIEMENS	CPU224 DC/DC/DC	24VDC	1	YE81022400000	
15	A2	PLC Analog module	SIEMENS	EM231 4xTC	--	1	YE82023100100	
16	A3	PLC Analog module	SIEMENS	EM231 4xAI	--	1	YE82023100000	(2)
17	A4	Human-machine interface	SCHNEIDER	GX03501	24VDC	1	YE80350100100	
18	FU1	Fuse base	CHINT	RT18-32	2P	1	YE41032200000	
19	FU2	Fuse	CHINT	10x38 500V	2A	2	YE46002000100	
20	FU2	Fuse	YINDA	FS-10	2A	1	YE41001000000	
21	T	Transformer	--	--	IN=400V OUT=230V 500mA	1	YE70402300800	
22	U	DC power	MEAN WELL	NES-35-24	OUT=DC24V 1.5A	1	YE71352400100	
23	H1	Buzzer	HITPOINT	PK-27A	24VDC	1	YE84002700000	(1)
24	H2	Alarm indicator	SHINI	LED-3051	24VDC	1	YE83305100300	(1)
25	S1	Micro switch	TEND	LXW5-11G1	250V 5(4)A	1	YE14511100000	(1)
版本 Ver.C								
Notes: (1)Means it's not the material inside the control box. (2)Stands for optional.								
D			Title	SDD-160U(230U)/120H-LC	Drawing NO.	SDD-160U(230U)/120H-LC-CE-400V-C-6	Scale	Page 6
			Version	C	Electrical Components list 1	Standard	CE	Page 7
			Designer	Approved by			Voltage	400V
			Proofread by				Frequency	50Hz
Mark			Before modification	Modified by	20160816	Checked by		
1	2	3	4	5	6	7	8	



信易电热机械股份有限公司  
Shini Plastics Technologies, Inc.



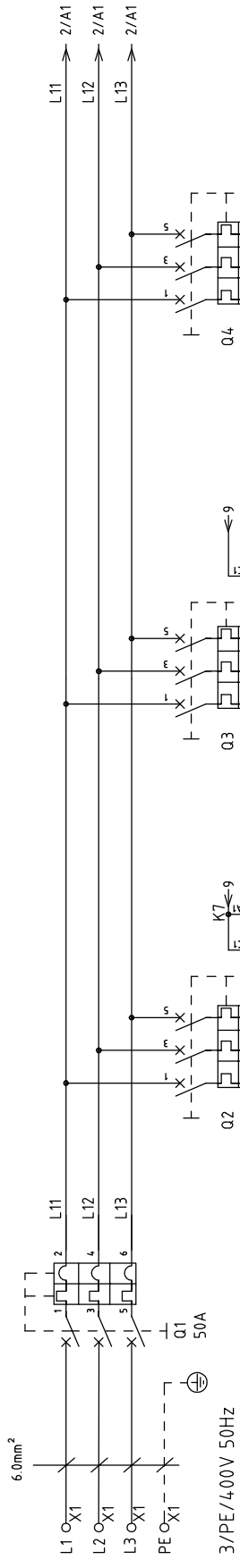

P=12kW  
IN=18A  
Drying heater

P=4kW  
IN=6A  
Regeneration heater

P=15kW  
IN=3.6A  
Drying blower

版本 Ver.C

Note: For 60Hz, the regenerative heater is 6kW

Mark	Before modification	Modified by	Modify date	Checked by	Date	Version	C	Title	Drawing NO.		Scale	Page 1
	After modification								SDD-300U(450U)/200H-LC	SDD-300U(450U)/200H-LC-CE-400V-C-1		
												
信易电热机械股份有限公司 Shini Plastics Technologies, Inc.												
Voltage 400V Frequency 50Hz												

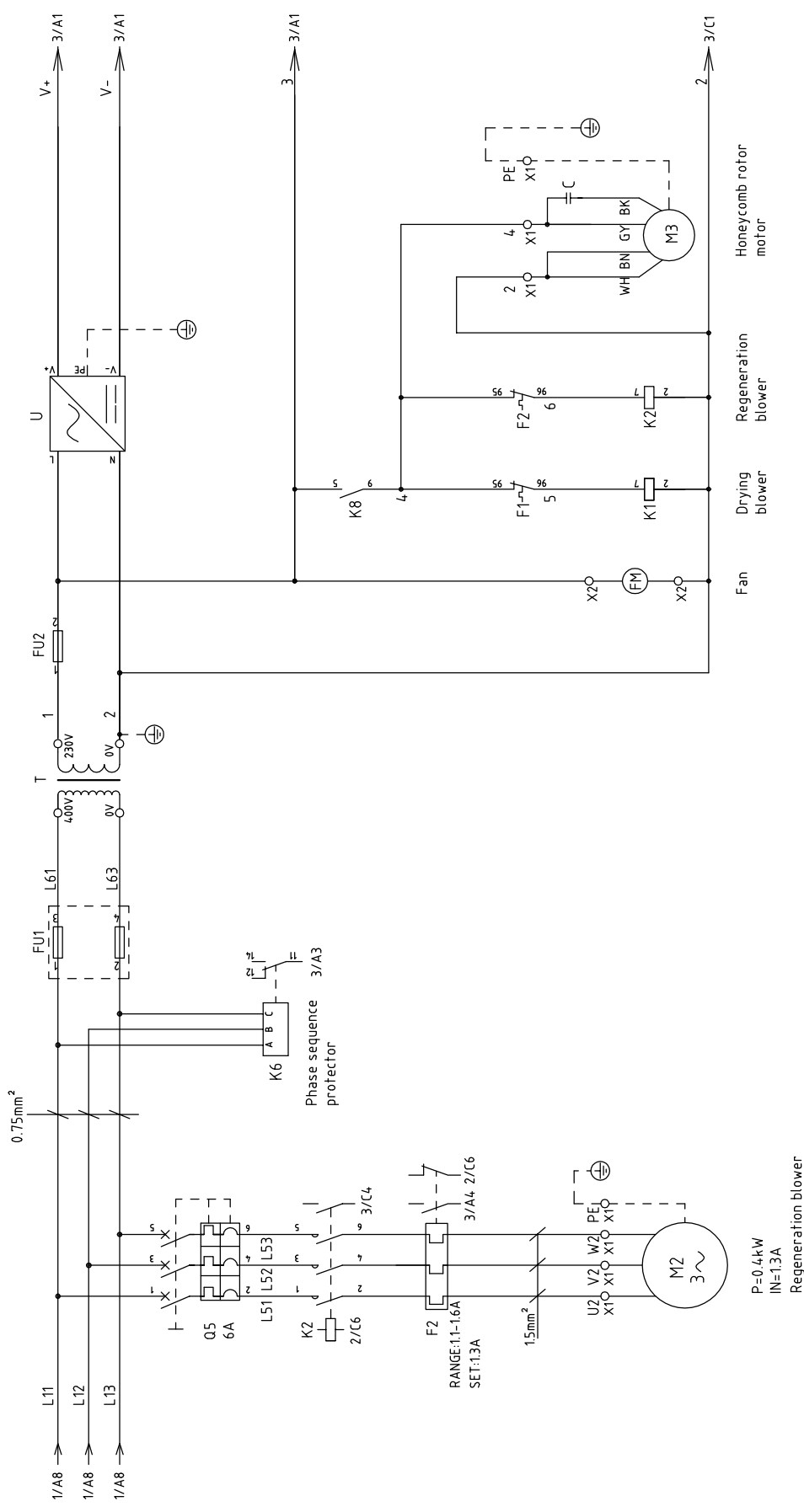

版本 Ver.C

Mark	Before modification	Modified by	20160914	Date	Version	C	Title	SDD-300U(450U)/200H-LC		Drawing NO.	Scale	Page	2
	After modification	Checked by	20160914					SDD-300U(450U)/200H-LC-CE-400V-C-2				Standard	CE
												Voltage	400V
												Frequency	50HZ



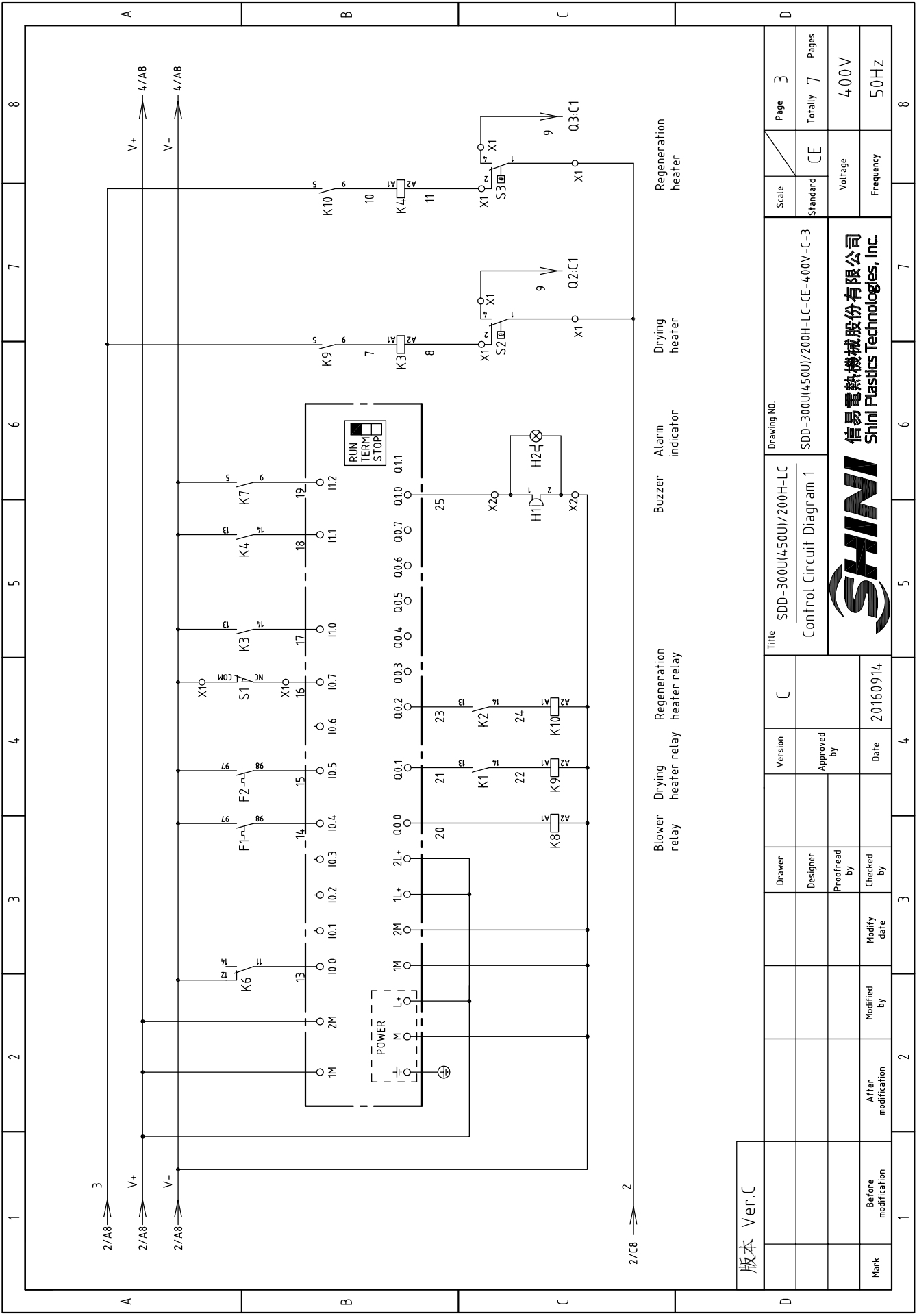

版本 Ver.C

Mark	Before modification	Modified by	Modify date	Version	C	Title	Drawing NO.		Page
	After modification	Modified by	Modify date				Standard	Pages	
SDD-300U(450U)/200H-LC Control Circuit Diagram 1							SDD-300U(450U)/200H-LC-CE-400V-C-3	CE	3
SHINI 信易電熱機械股份有限公司 Shini Plastics Technologies, Inc.							Voltage	400V	7
							Frequency	50HZ	8





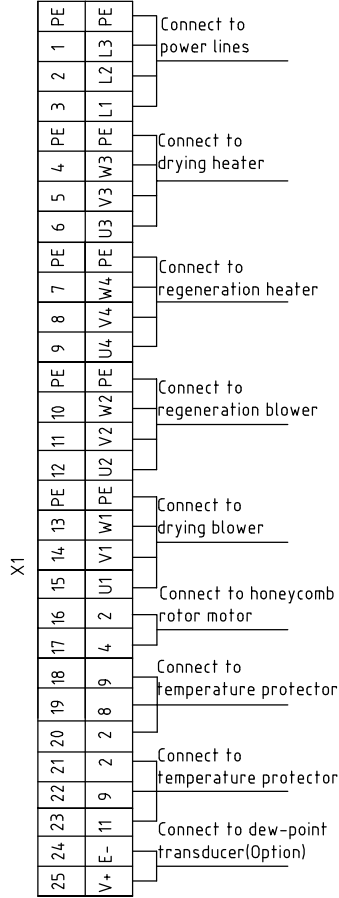
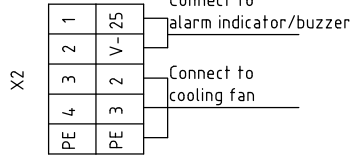
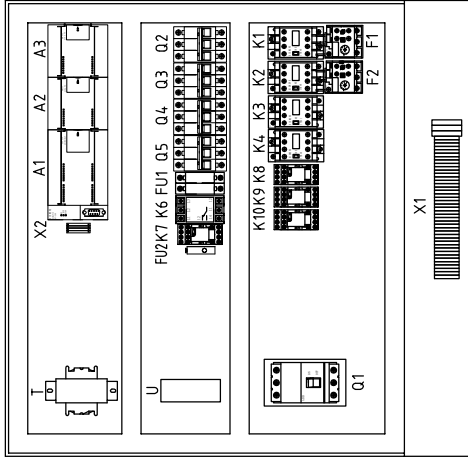
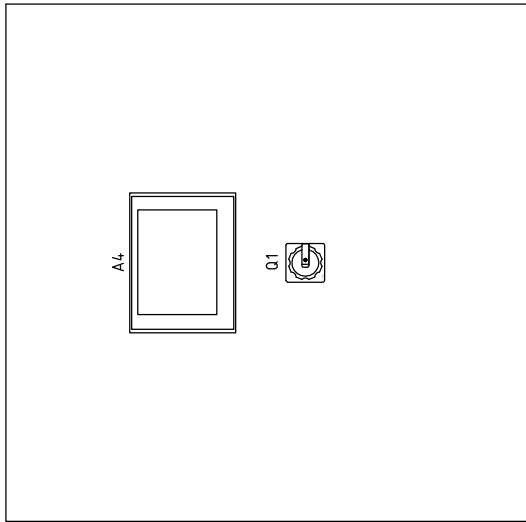

版本 Ver.C

Power cable can directly connected to the breaker interlock which not pass by the terminal board.

Mark	Before modification	Modified by	Modify date	Version	C	Title	SDD-300U(450U)/200H-LC		Scale	Page	5
	After modification						Standard	Totally		7	
Electrical Components Layout							SDD-300U(450U)/200H-LC-CE-400V-C-5		Voltage		400V
SHINI							信易電熱機械股份有限公司 Shini Plastics Technologies, Inc.		Frequency		50HZ

1	2		3	4	5	6	7	8
NO.	Symbol	Name	Manufacturer	Type	Specification	Number	Material number	Remark
1	Q1	Main switch	ABB	A1A125TMF50	50A	1	YE4.1105200000	
2	Q2	Circuit-breaker	TECO	BM-63C 3P	32A	1	YE4.0303203000	
3	Q3	Circuit-breaker	TECO	BM-63C 3P	16A	1	YE4.0301603000	
4		Excitation release	CHINT	MX	220V 50/60Hz	2	YE4.0023560000	
5	Q4	Circuit-breaker	TECO	BM-63C 3P	10A	1	YE4.0301003000	
6	Q5	Circuit-breaker	TECO	BM-63C 3P	6A	1	YE4.0300603000	
7	K1	Confactor	SIEMENS	3RT6016-1AN21	220V 50/60Hz	1	YE00601621000	
8	K2	Confactor	SIEMENS	3RT6016-1AN21	220V 50/60Hz	1	YE00601621000	
9	K3	Confactor	SIEMENS	3RT6026-1AN20	220V 50/60Hz	1	YE00602622000	
10	K4	Confactor	SIEMENS	3RT6017-1AN21	220V 50/60Hz	1	YE00601721000	
11	K6	Phase relay	CHAOSHI	ABJ-10W	400V 50/60Hz	1	YE03103800000	
12	K7	Middle relay	WEIDMULLER	DRM270730LT	220V 50/60Hz	1	YE03270700000	
13	K8 K9 K10	Middle relay	WEIDMULLER	DRM270724LT	24VDC	3	YE03272400000	
14	F1	Thermo overload relay	SIEMENS	3RU6116-1FB0	3.5-5A	1	YE01160350000	
15	F2	Thermo overload relay	SIEMENS	3RU6116-1AB0	1.1-1.6A	1	YE01160110000	
16	A1	PLC	SIEMENS	CPU224 DC/DC/DC	24VDC	1	YE81022400000	
17	A2	PLC Analog module	SIEMENS	EM231 4xTC	--	1	YE82023100100	
18	A3	PLC Analog module	SIEMENS	EM231 4xAI	--	1	YE82023100000	(2)
19	A4	Human-machine interface	SCHNEIDER	GX03501	24VDC	1	YE80350100100	
20	FU1	Fuse base	CHINT	RT18-32	2P	1	YE4.1032200000	
21		Fuse	CHINT	10x38 500V	2A	2	YE4.6001000100	
22	FU2	Fuse	YINDA	FS-10	2A	1	YE4.1001000000	
23	T	Transformer	--	--	IN=400V OUT=230V 800mA	1	YE704.02300900	
24	U	DC power	MEAN WELL	NES-35-24	OUT=DC24V 1.5A	1	YE713524.00100	
25	H1	Buzzer	HITPOINT	PK-27A	24VDC	1	YE84.002700000	(1)

Notes: (1)Means it's not the material inside the control box. (2)Stands for optional.

版本 Ver.C

D	E	F	G	H	I	J	K	L	
Mark	Before modification	Modified by	Modify date	Checked by	Proofread by	Designer	Drawer	Version	
								C	
								Approved by	
								Date	
								20160914	
Title		SDD-300U(450U)/200H-LC		Drawing NO.		SDD-300U(450U)/200H-LC-CE-400V-C-6		Page	6
Electrical Components list 1								Standard	CE
								Voltage	400V
								Frequency	50HZ
								Totally	7
								Pages	



信易電熱機械股份有限公司  
Shini Plastics Technologies, Inc.









