

1 2 3 4 5 6 7 8

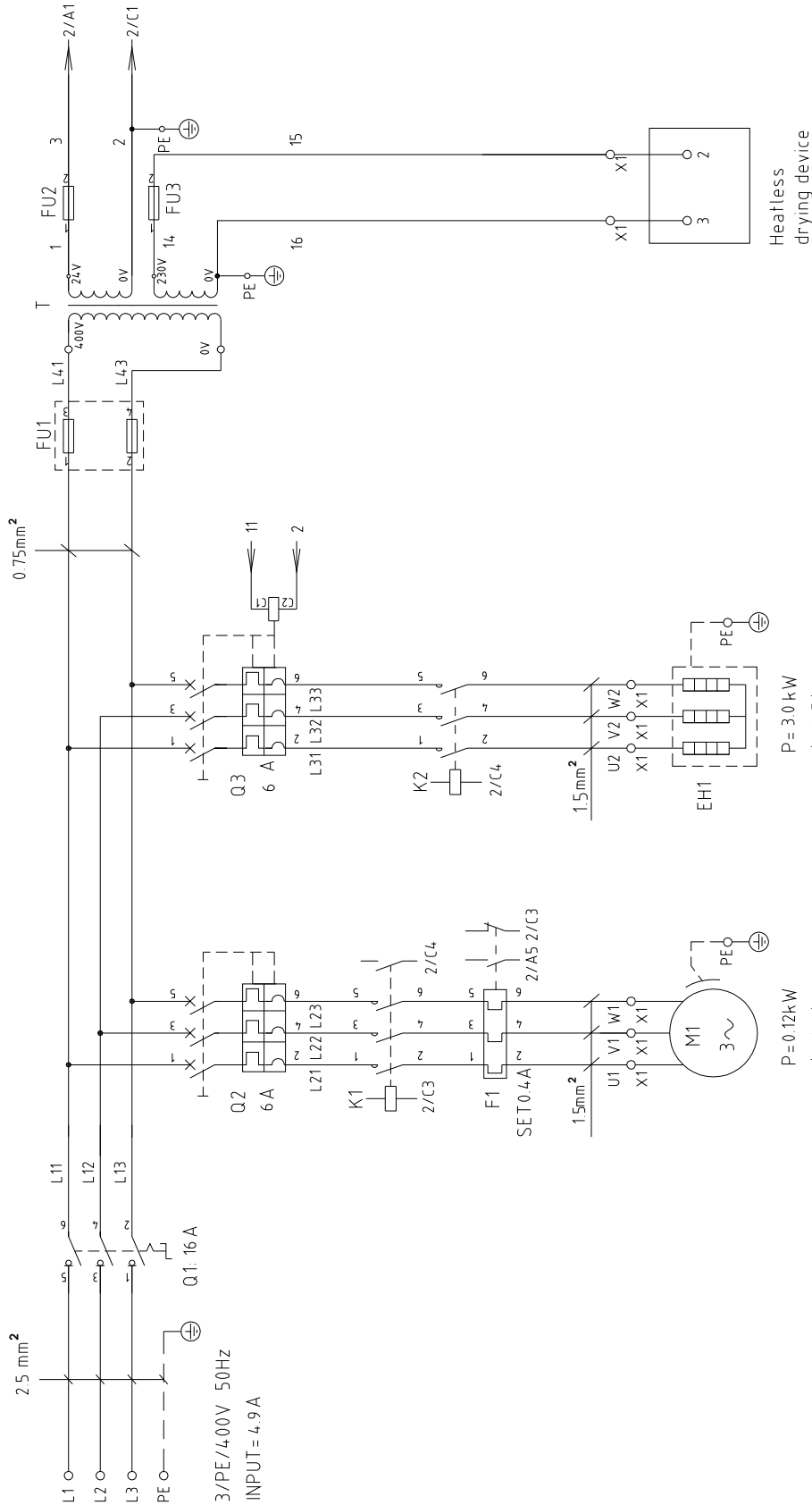

版本 Ver.C

D		Title		Version		Scale		Page	
SHD-40U-HD		0				Standard CE		1	
Main Circuit Diagram		Approved by		Designer		Voltage		Totally 4	
SHD-40U-HD-CE-400V-0-1		Date		Proofread by		Frequency		Pages	
20170802		Checked by		Modified by		400V		4	
20170802		After modification		Modified by		50HZ		8	



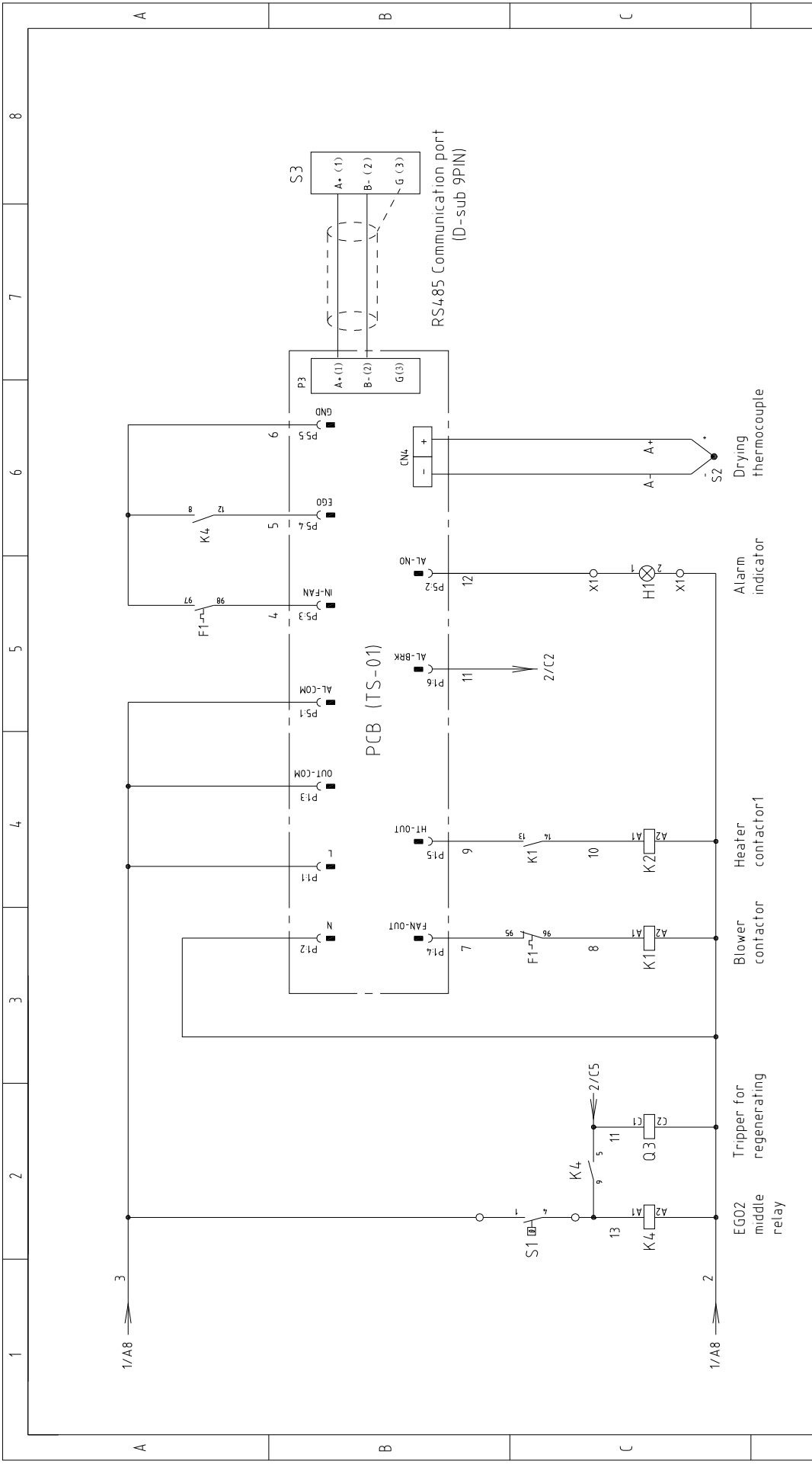

版本 Ver.C

Mark	Before modification	Date	20170802	Version	0	Title	SHD-40U-HD		Drawing NO	SHD-40U-HD-CE-400V-0-2		Page	2
	After modification						Modified by	Modified date		Approved by	Standard		CE
Frequency	50HZ									Voltage	400V		
													
信易電熱機械股份有限公司 Shini Plastics Technologies, Inc.													
Control Circuit Diagram													
Scale: Standard													
Frequency: 50HZ													
Voltage: 400V													
Standard: CE													
Drawing NO: SHD-40U-HD-CE-400V-0-2													
Page: 2													
Totaly: 4													

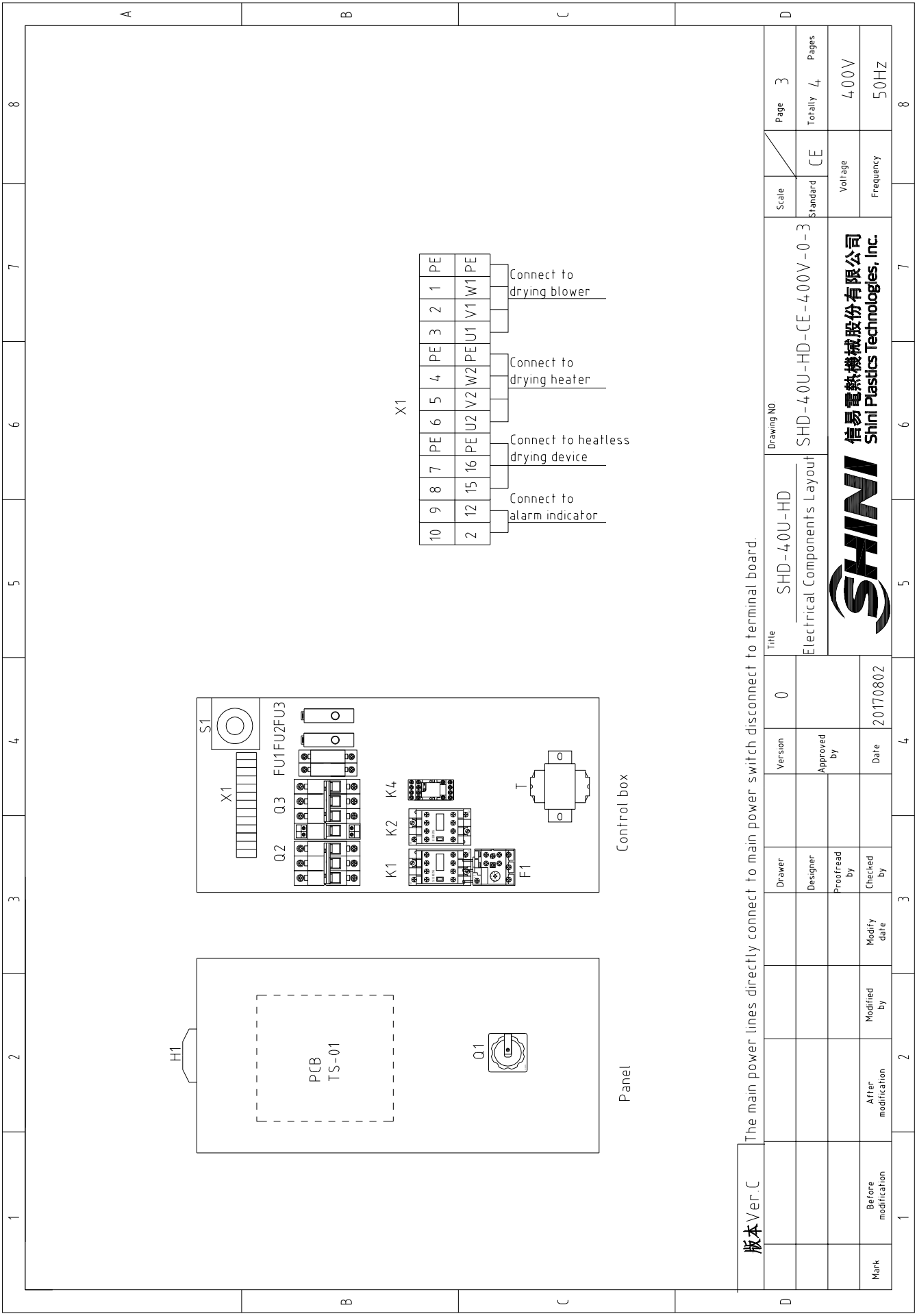

版本 Ver.C The main power lines directly connect to main power switch disconnect to terminal board.

D	Mark	Before modification	Modified by	Modify date	Checked by	Date	20170802
	Mark	After modification	Modified by	Modify date	Checked by	Date	20170802
	Drawer	Designer	Proofread by	Approved by	Version	0	
	Title		SHD-40U-HD		Drawing NO		SHD-40U-HD-CE-400V-0-3
	Scale		Standard		Standard		CE
	Page		3		Totally		4
	Voltage		400V		Frequency		50HZ
	SHINI		信易電熱機械股份有限公司		SHINI		Shini Plastics Technologies, Inc.
	1		2		3		4
	5		6		7		8

1	2		3	4	5	6	7	8
NO.	Symbol	Name	Manufacturer	Type	Specification	Number	Material number	Remark
1	Q1	Main power switch	EATON	T0-2-1/EA/SVB/16A	16A 3P 690V 50/60Hz	1	YE10021160000	
2	Q3	Circuit-breaker	TECO	BM-63C/3006S	6A 3P	1	YE40300603000	
3		Excitation release	CHINT	MX	24V 50/60Hz	1	YE40024000000	A
4	Q2	Circuit-breaker	TECO	BM-63C/3006S	6A 3P	1	YE40300603000	
5	K1	Contactor	SIEMENS	3RT6015-1AB01	7A 3P 1N0 24V AC	1	YE00601502500	
6	K2	Contactor	SIEMENS	3RT6016-1AB01	9A 3P 24V AC	1	YE00601602500	
7	K4	Middle relay	HONEYWELL	GR-2C-AC24V配塵PGR-2C-E	24V 50/60Hz	1	YE03022400300	
8	F1	Overload relay	SIEMENS	3RU6116-0FB0	0.35-0.5A 690V 50/60Hz	1	YE01161350000	
9	FU1	Fuse base	CHINT	RT28-32	2P/32A/500V/10x38	1	YE410322200000	
10		Fuse core	CHINT	10x38 500V/gG型	2A	2	YE46002000100	
11	FU2 FU3	Fuse	YINDA	FS-10	6x30mm 5A 250V	2	YE410010000000/YE46630500100	B
12	T	Transformer	BAIYUN	IN=400V OUT=24V AC 120VA/230V 350MA		1	YE70040005500	
13	PCB	PCB	YUYUN	TS-0124VAC(include communicator)	24V 50/60Hz	1	YE80012400400	
14		Control box SSMD(SHD-40U-C-02)ABS+PC(30%)				1	YR40400200000	
15		Lampshade(SIC-015)				1	YR90441300000	
16		Panel for SHD20U-1200U(Ch&Eng)Version sickness >65NI(SHD-20U-A-41/Pressing plate of display screen for SHD-80U-A-43I88x53x0.3x10) 0				1	YR01000000100/YR900000003300	
17		Panel for SHD20U-1200U(Eng)Version sickness<65NI/Pressing plate of display screen for SHD-80U-A-43I88x53x0.3x10) 0				1	YR01002000100/YR900000003300	
18	S1	Temp. protector	EGO	--	115-320 °C	1	BH90115000150	
19	S2	Thermocouple	SHINI	K TYPE	--	1	----	(1)
20	H1	Alarm indicator	SHINI	LED-3051紅白色	24V AC	1	YE83305100900	
21	X1	Terminal		--	2.5mm ²	10	YE60002503200	
22		Terminal		--	2.5mm ² PE	3	YE60002503400	
23	M1	Blower	--	--	0.12kW	1	----	(1)
24	EH1	Heater	SHINI	--	3.0kW	1	----	(1)
25	S3	Communication interface board RS-485 (double Dsub-9pin connector)	--	--	--	1	YE90048501200	
版本 Ver.C								
Notes: (1)Means it's not the material inside the control box.								
			Drawer	Version	Title	Drawing NO		
			Designer	0	SHD-40U-HD	SHD-40U-HD-CE-4.00V-0-4		Page 4
			Proofread by	Approved by	Electrical Components List		Standard	Totally 4 Pages
			Checked by	Date	SHINI		CE	
Mark	Before modification	After modification	Modified by	Modify date	20170802		Voltage	400V
							Frequency	50HZ
1	2	3	4	5	6	7	8	



信易電熱機械股份有限公司
Shini Plastics Technologies, Inc.

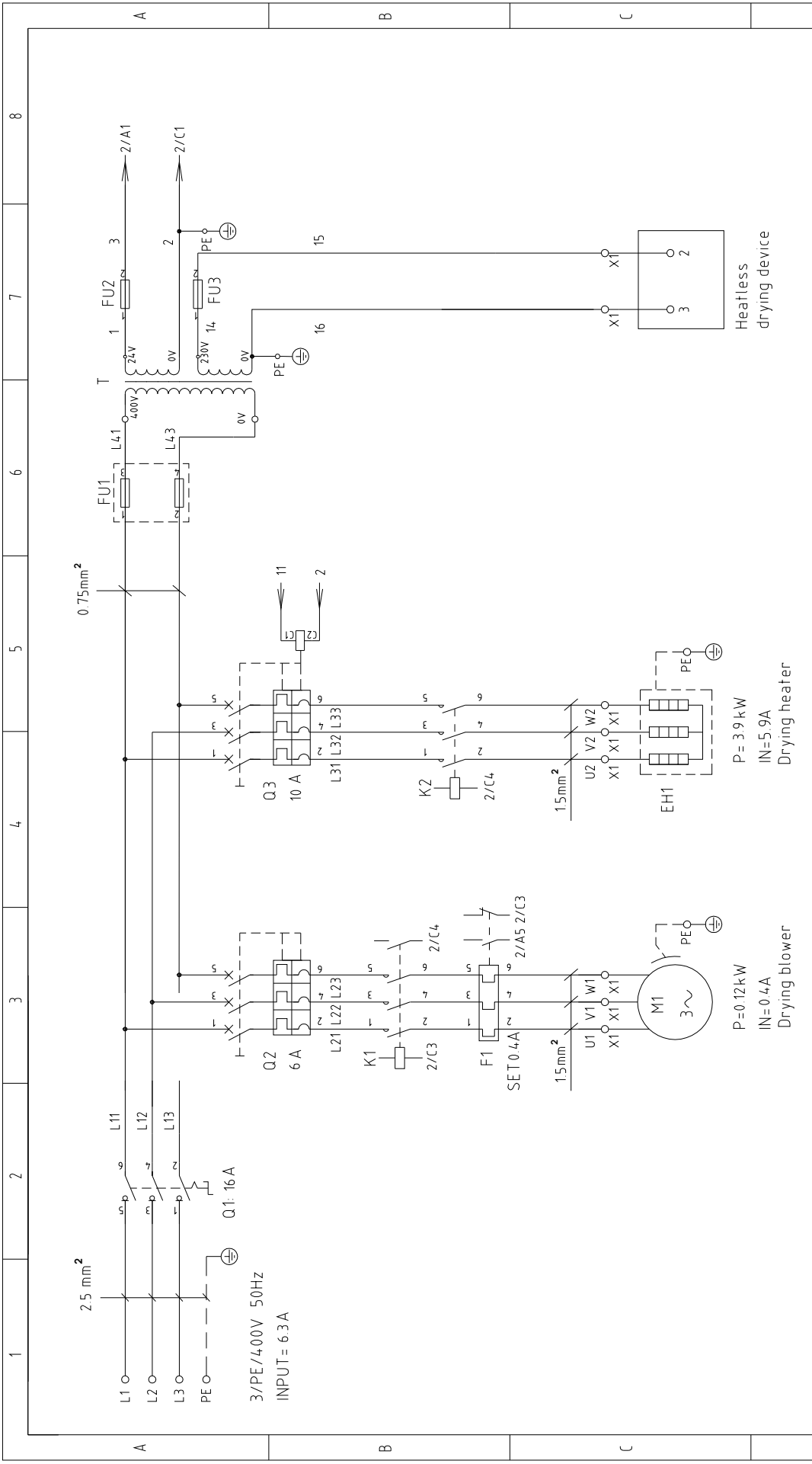

版本 Ver.C		Title		Version		Drawing NO		Scale		Page	
		SHD-80U/120U-HD		0		SHD-80U/120U-HD-		Standard		Page 1	
		Main Circuit Diagram		Approved by		CE-400V-0-1		CE		Totally 4 Pages	
		Date		Date		Voltage		Voltage		400V	
		20170802		20170802		Frequency		Frequency		50Hz	
Mark		Before modification		Modified by		Modified date		Modified date			
1		2		3		4		5		6	
7		8		9		10		11		12	



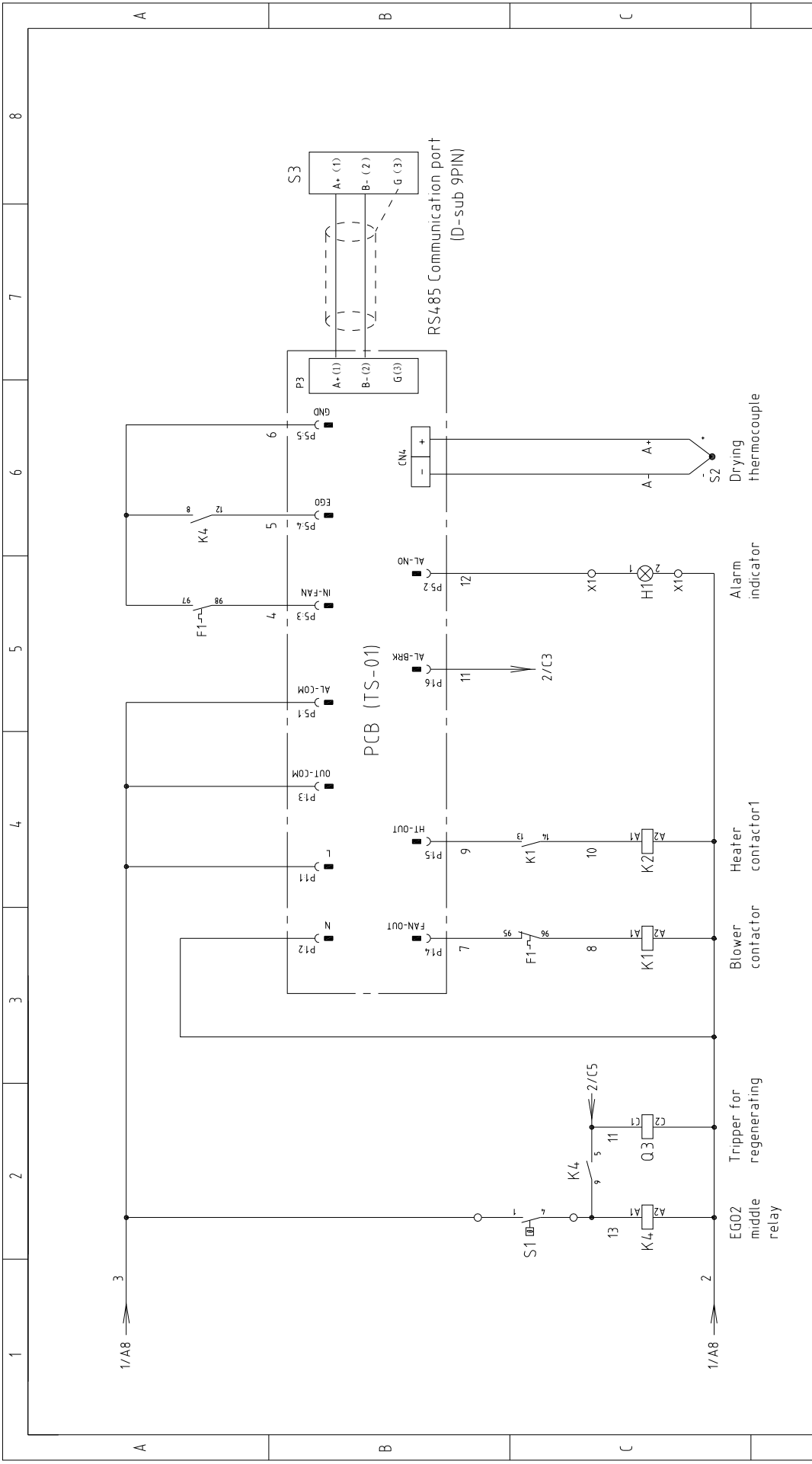

版本 Ver.C

D	Scale	Standard	CE	Page	2
	Voltage	Frequency	400V	Totally	4
Title		SHD-80U/120U-HD Control Circuit Diagram		Drawing NO SHD-80U/120U-HD- CE-400V-0-2	
Version	0	Approved by		Date	20170802
Designer		Proofread by		Modified by	
Checked by		Modify date		After modification	
Mark	Before modification				



1	2		3	4	5	6	7	8	
NO.	Symbol	Name	Manufacturer	Type	Specification	Number	Material number	Remark	
1	Q1	Main power switch	EATON	T0-2-1EA/SVB/16A	16A 3P 690V 50/60Hz	1	YE10021160000		
2	Q3	Circuit-breaker	TECO	BM-63C/3010S	10A 3P	1	YE40301003000		
3		Excitation release	CHINT	MX	24V 50/60Hz	1	YE40024000000	A	
4	Q2	Circuit-breaker	TECO	BM-63C/3006S	6A 3P	1	YE40300603000		
5	K1	Contact	SIEMENS	3RT6015-1AB01	7A 3P 1NO 24V AC	1	YE00601502500		
6	K2	Contact	SIEMENS	3RT6016-1AB01	9A 3P 24V AC	1	YE00601602500		
7	K4	Middle relay	HONEYWELL	GR-2C-AC24V配座PGR-2C-E	24V 50/60Hz	1	YE03022400300		
8	F1	Overload relay	SIEMENS	3RU6116-0FB0	0.35-0.5A 690V 50/60Hz	1	YE01161350000		
9	FU1	Fuse base	CHINT	RT28-32	2P/32A/500V/10x38	1	YE41032200000		
10		Fuse core	CHINT	10x38 500V/gG型	2A	2	YE46002000100		
11	FU2 FU3	Fuse	YINDA	FS-10	6x30mm 5A 250V	2	YE41001000000/YE4663050100	B	
12	T	Transformer	BAIYUN	IN=400V OUT=24V AC 120VA/230V 350MA		1	YE70040005500		
13	PCB	PCB	YUYUN	TS-01024-VAC(include communicator)	24V 50/60Hz	1	YE80012400400		
14		Control box SSMD(SHD-40U-C-02)ABS+PC(30%)				1	YR40400200000		
15		Lampshade(SIC-015)				1	YR90441300000		
16		Panel for SHD20U-1200U(Ch&Eng)Version sickness>65N(SHD-20U-A-41/Pressing plate of display screen for SHD-80U-A-43188x53±0.3x10) 0				1	YR01000000100/YR900000003300		
17		Panel for SHD20U-1200U(Eng)Version sickness65N/Pressing plate of display screen for SHD-80U-A-43188x53±0.3x10) 0				1	YR01002000100/YR900000003300		
18	S1	Temperature protector	EGO	--	115-320 °C	1	BH90115000150		
19	S2	Thermocouple	SHINI	K TYPE	--	1	----	(1)	
20	H1	Alarm indicator	SHINI	LED-3051蓝白色	24V AC	1	YE83305100900		
21	X1	Terminal		--	2.5mm ²	10	YE60002503200		
22		Terminal		--	2.5mm ² PE	3	YE60002503400		
23	M1	Blower	--	--	0.12kW	1	----	(1)	
24	EH1	Heater	SHINI	--	3.9kW	1	----	(1)	
25	S3	Communication interface board RS-485 (double Dsub-9pin connector)	--	--	--	1	YE90048501200		
版本 Ver.C									
Notes: (1)Means it's not the material inside the control box.									
D			Title	SHD-80U/120U-HD	SHD-80U/120U-HD	Drawing NO	SHD-80U/120U-HD-CE-400V-0-4	Page	4
			Version	0	Electrical Components list 1	Standard	CE	Totally	4
			Designer	Approved by	Voltage	Frequency	400V	Pages	50HZ
Mark			Before modification	Modified by	Modify date	Date	20170802	4	8



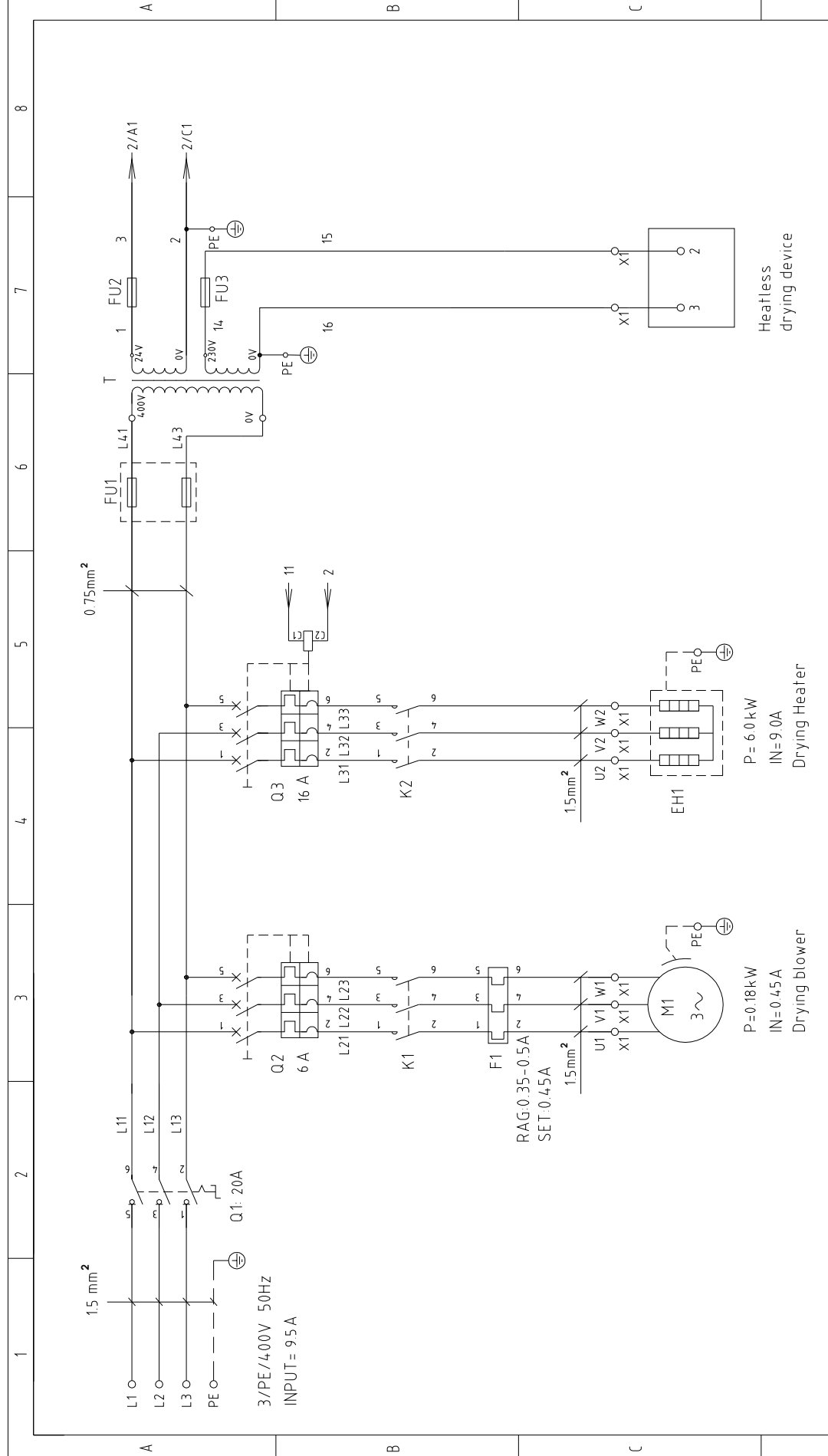

版本 Ver.B		Title		Version		Title		Scale		Page	
		SHD-230U-HD		0		SHD-230U-HD -		Standard		Page 1	
		Main Circuit Diagram		Approved by		CE-400V-0-1		CE		Totally 5 Pages	
		Date		Checked by		Voltage		Voltage		400V	
		20180113		Modify date		Frequency		Frequency		50Hz	
Mark		After modification		Modified by							
1		2		3		4		5		6	
7		8		9		10		11		12	



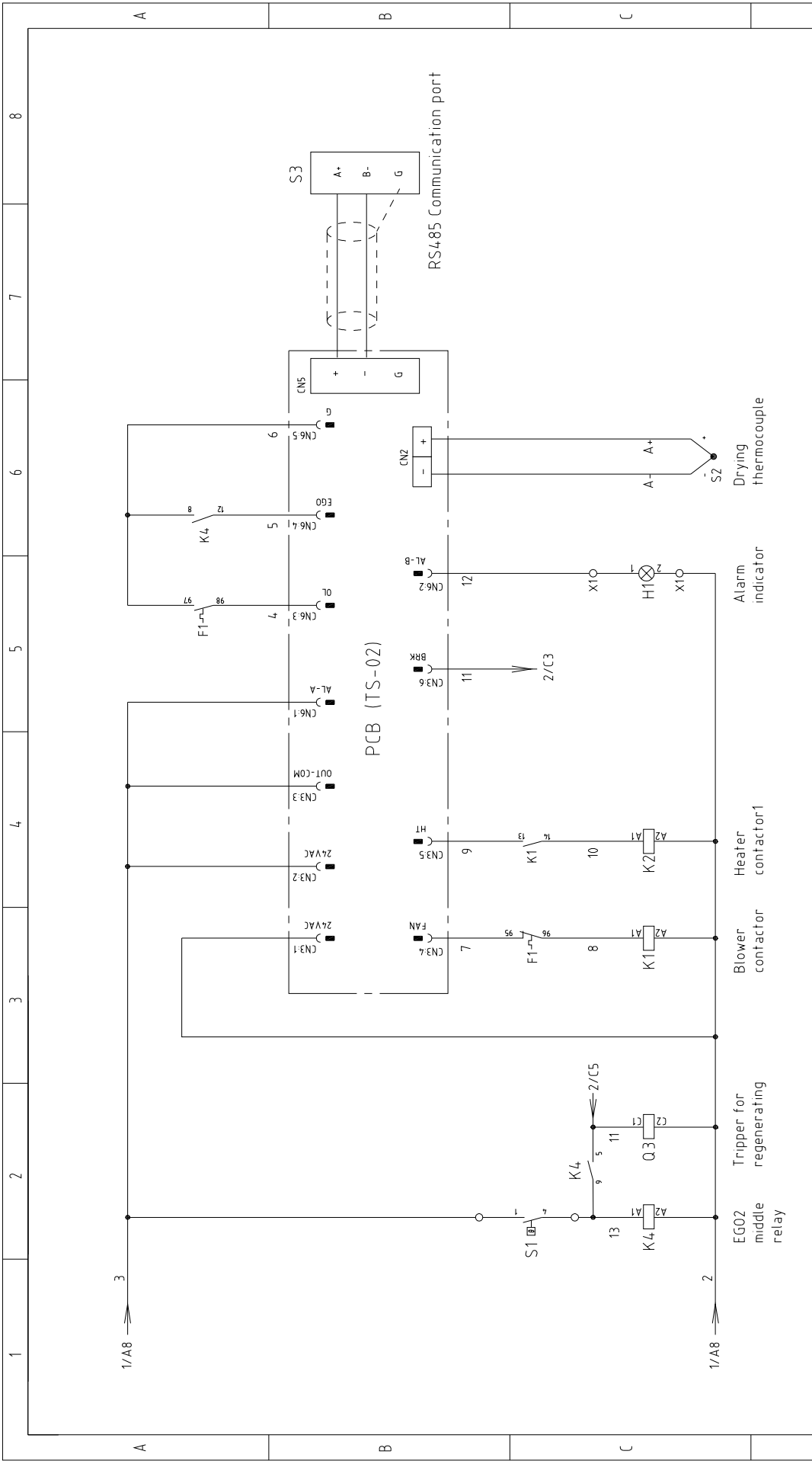

版本 Ver.B

Mark	Before modification	After modification	Modified by	Modify date	Date	20180113	Approved by	Version	0	Title	SHD-230U-HD - Control Circuit Diagram		Drawing NO	SHD-230U-HD - CE-400V-0-2		Scale	Page	2	
												Standard		CE	Totally		5	Pages	
1	2	3	4	5	6	7	8												



1 2 3 4 5 6 7 8

A B C

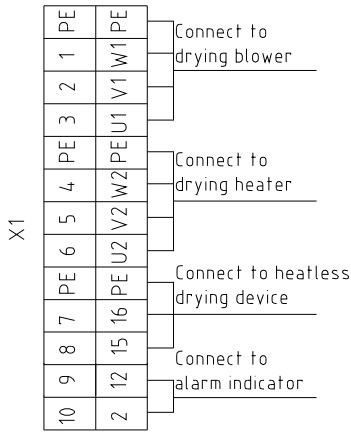
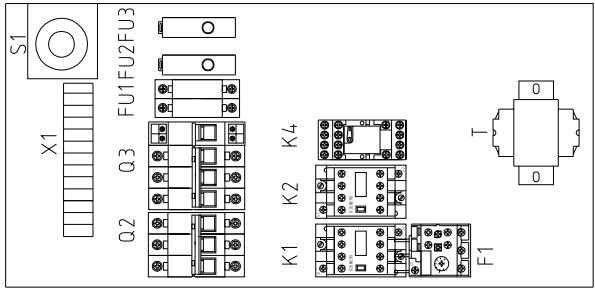
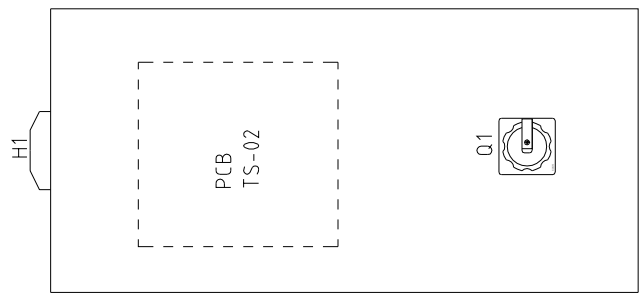

版本 Ver.B

The main power lines directly connect to main power switch disconnect to terminal board.

D	Mark	Before modification	Modified by	Modify date	Checked by	20180113	Date	Approved by	Version	0	Title	SHD-230U-HD - Electrical Components Layout		Scale	Standard	CE	Page	3
		After modification										SHD-230U-HD - CE-400V-0-3		Standard	CE	Totally	5	Pages
												Voltage						400V
												Frequency						50HZ
																		8



1	2		3	4	5	6	7	8
NO.	Symbol	Name	Manufacturer	Type	Specification	Number	Material number	Remark
1	Q1	Main Switch	EATON	T0-2-1/EA/SVB/20A	20A 3P 4.00V 50/60Hz	1	YE10021160000	
2	Q3	Circuit-breaker	TECO	BM-63C/3016S	16A 3P	1	YE4.0301603000	
3		Excitation Release	TECO	MX	24V 50/60Hz	1	YE4.0024.000000	A
4	Q2	Circuit-breaker	TECO	BM-63C/3006S	6A 3P	1	YE4.0300603000	
5	K1	Contactor	SIEMENS	3RT6015-1AB01	7A 3P 1NO 24V AC	1	YE00601502500	
6	K2	Contactor	SIEMENS	3RT6018-1AB01	16A 3P 24V AC	1	YE00601802500	
7	K4	Middle Relay	HONEYWELL	GR-2C-AC24V配座PGR-2C-E	24V 50/60Hz	1	YE030224.00300	
8	F1	Thermo Overload Relay	SIEMENS	3RU6116-0FB0	0.35-0.5A 690V 50/60Hz	1	YE01161350000	
9	FU1	Fuse Base	CHINT	RT28N-32/2P/32A/500V/10x38		1	YE4.10322200000	
10		Fuse Core	CHINT	10x38 500V/gG型	2A	2	YE4.6002000100	
11	FU2	Fuse	YINDA	FS-101/6x30		1	YE4.1001000000	B
12		Fuse core	-----	6x30	5A	2	YE4.6630500100	
13	T	Transformer	-----	IN=4.00V OUT=24V /230V	120VA/350mA	1	YE7004.0005500	
14	PCB	PCB	YUYUN	TS-02(24VAC)(含通讯)	24V 50/60Hz	1	YE80000101200	
15		Control box SSMD(SHD-40U-C-02)	ABS+PC(30%)			1	YR4.04.002000000	
16		Lamp cover(SIC-015)				1	YR9044.1300000	
17		Panel for SHD20U-1200U(ZN&CN)Version sickness>65N				1	YR01804.1000000	
18		Pressing plate of display screen SHD-80U-A-4.3(88x53+0.3x1.0) 0				1	YR90000003300	
19	S1	EGO	----	115-320℃ 55.13262.160	不带塑胶保护盒	1	BH90115000150	
20	S2	Thermocouple	SHINI	5x4.0LxM8x1.5M (SHD-120U-A+12.0版)		1	----	(1)
21	H1	Alarm Indicator	SHINI	LED-3051红白色	24V AC	1	YE83305100900	
22	X1	Terminal		--	4mm ²	6	YE6000004.03200	
23					4mm ² PE	2	YE6000004.03500	
24					2.5mm ²	4	YE60002503200	
25					2.5mm ² PE	1	YE60002503400	

版本 Ver.B		Notes: (1)Means it's not the material inside the control box.	
Mark	Before modification	Modified by	Modify date
			20180113
	After modification	Checked by	Date
			20180113
		Proofread by	Approved by
		Designer	Version
		0	0
Title		SHD-230U-HD	
Drawing NO		SHD-230U-HD-CE-400V-0-4	
Electrical Components list 1		SHD-230U-HD-CE-400V-0-4	
Scale		CE	
Standard		Voltage	
CE		400V	
Page		Frequency	
4		50HZ	
Totally		5	
Pages		8	



