

- Ⓐ Main power wire dia. Ⓒ② Regeneration heater breaker Ⓔ Regeneration blower wire dia. Ⓚ Drying blower wire dia.
- Ⓑ Main power switch Ⓒ③ Drying blower breaker Ⓕ Regeneration blower power Ⓛ Drying blower power
- Ⓒ① Regeneration blower breaker Ⓖ Default regeneration blower overload relay Ⓜ Regeneration heater current Ⓝ Drying blower current

Mode	Symbol	Ver.	(a)	(b)	(c1)	(c2)	(c3)	(d)	(e)	(f)	(g)	(h)	(i)	(j)	(k)	(l)	(m)
SD-120H-SM4		Ver.B	2.5	16	10	10	10	1.3	1.5	0.4	1.3	2.5	3	4.5	1.5	0.75	2.2
SD-200H-SM4		Ver.B	2.5	16	10	10	10	1.3	1.5	0.4	1.3	2.5	4	6	1.5	1.5	3.3
SD-400H-SM4		Ver.A	6.0	25	16	16	20	2.2	1.5	0.75	2.2	2.5	7.2	10.4	1.5	3.75	7.4

机型版本 Ver.A

Drawing NO.	SD-xxxH-SM4		SD-xxxH-SM4-CE-4.00V-0-1		Scale	Page 1
	Parameter List of Circuit Diagram				Standard CE	Totally 14 Pages
Title		SD-xxxH-SM4		Voltage		4.00V
Version		0		Frequency		50HZ
Approved by						
Date		20160914				
Designer						
Proofread by						
Checked by						
Modify date						
After modification						
Before modification						



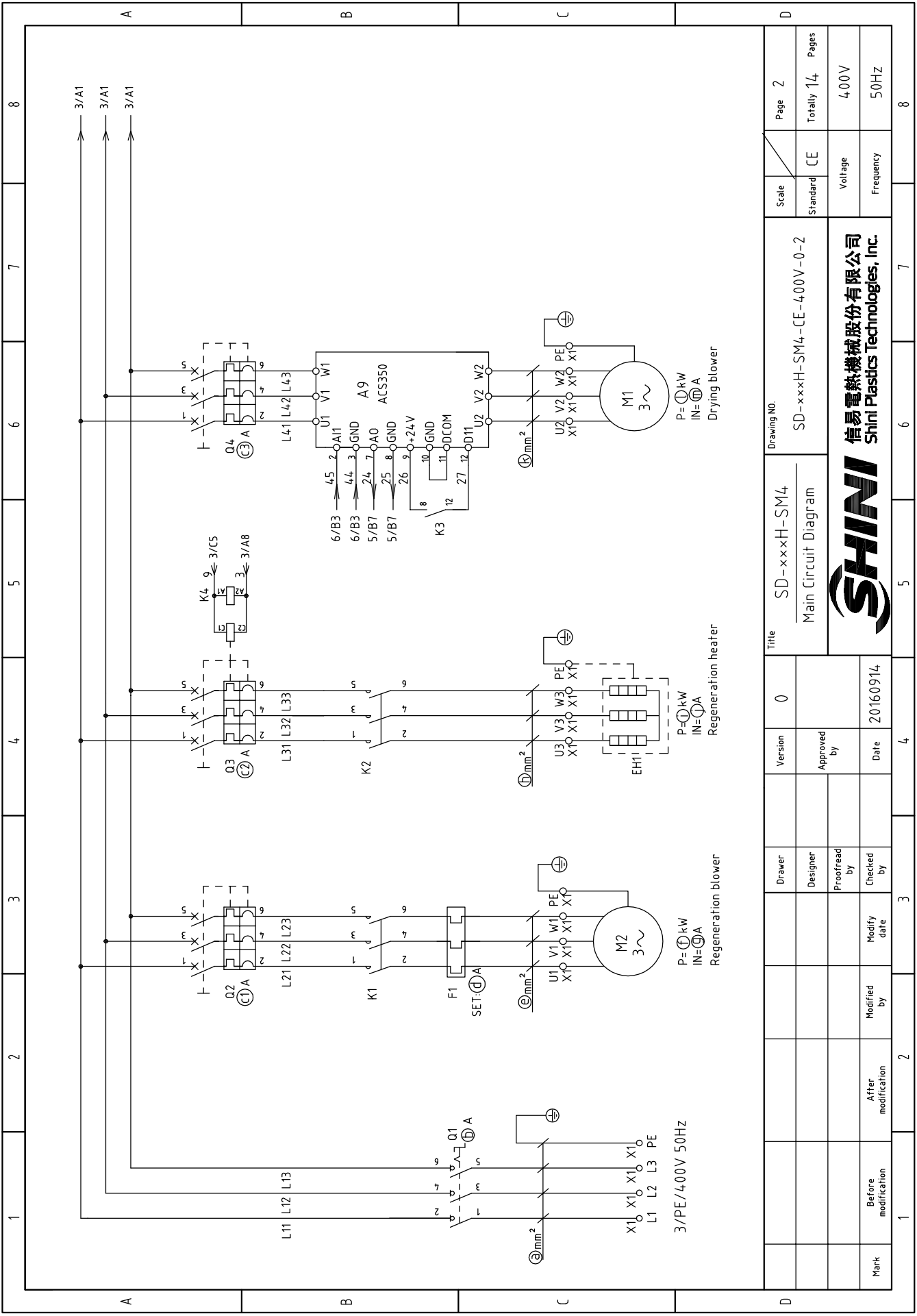

Mark		Before modification	After modification	Modified by	Modify date	Checked by	Proofread by	Designer	Drawer	Version	Title	Drawing NO.		Scale	Page
										0	SD-xxxH-SM4	SD-xxxH-SM4-CE-400V-0-2		Standard	Page 2
Approved by		Date		Approved by		Date		Approved by		Title		Standard		Page	
		20160914								Main Circuit Diagram		CE		Totally 1/4 Pages	
Voltage		Frequency		Voltage		Frequency		Voltage		Frequency		Voltage		Frequency	
400V		50Hz		400V		50Hz		400V		50Hz		400V		50Hz	
															
信易電熱機械股份有限公司 Shini Plastics Technologies, Inc.															

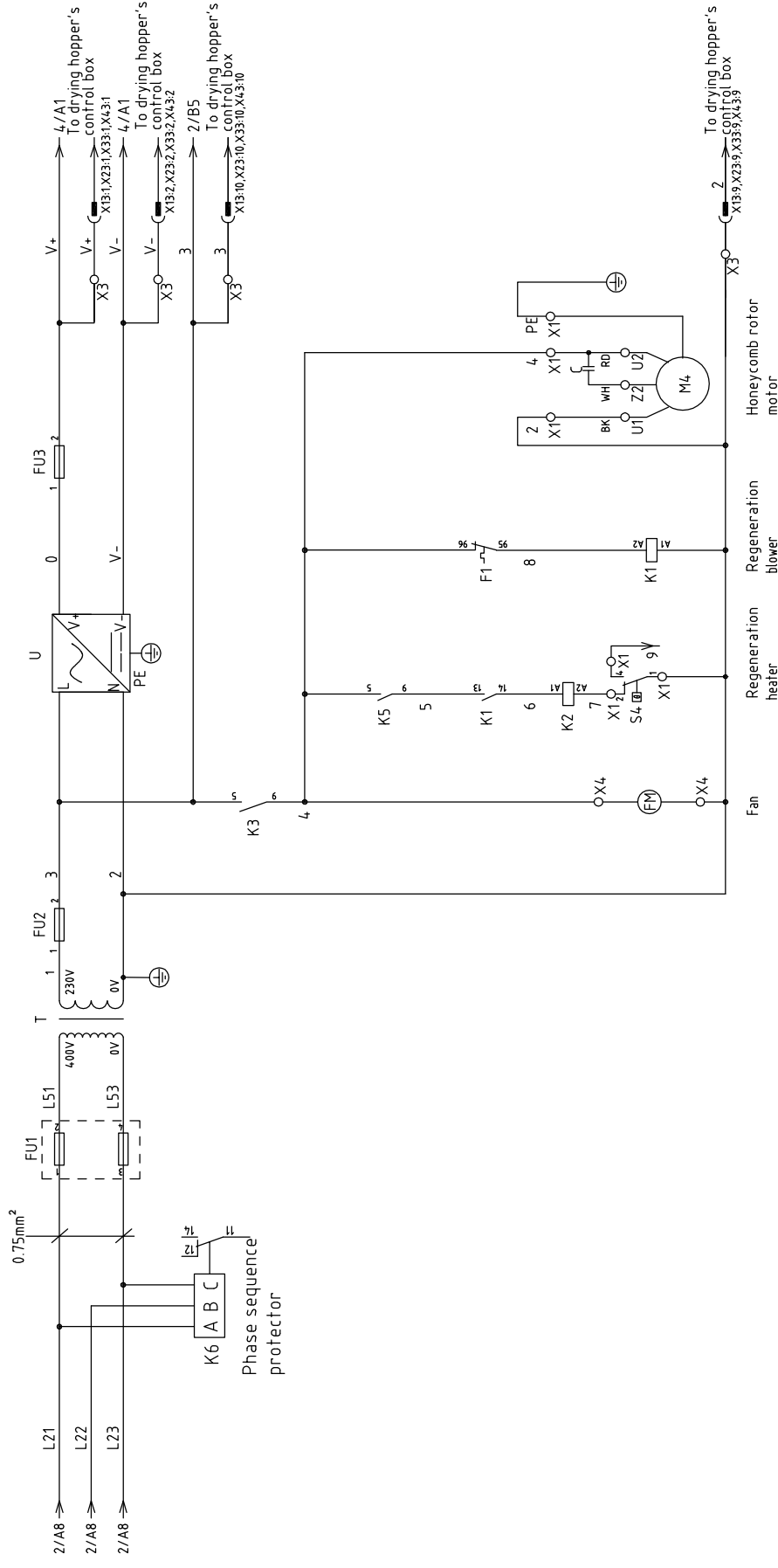

1	2	3	4	5	6	7	8
Title		Version		Drawing NO.		Scale	
SD-xxxH-SM4		0		SD-xxxH-SM4-CE-400V-0-3		Standard	
Electrical Diagram 1		Approved by		SHINI		Voltage	
Date		Date		信易電熱機械股份有限公司		Frequency	
20160914		20160914		Shini Plastics Technologies, Inc.		400V	
Mark		Modified by		Page		Totally	
Before modification		After modification		3		14	
Modified by		Modified by		Pages		Voltage	
Modify date		Modify date		400V		Frequency	
20160914		20160914		50HZ		400V	
3		4		7		8	

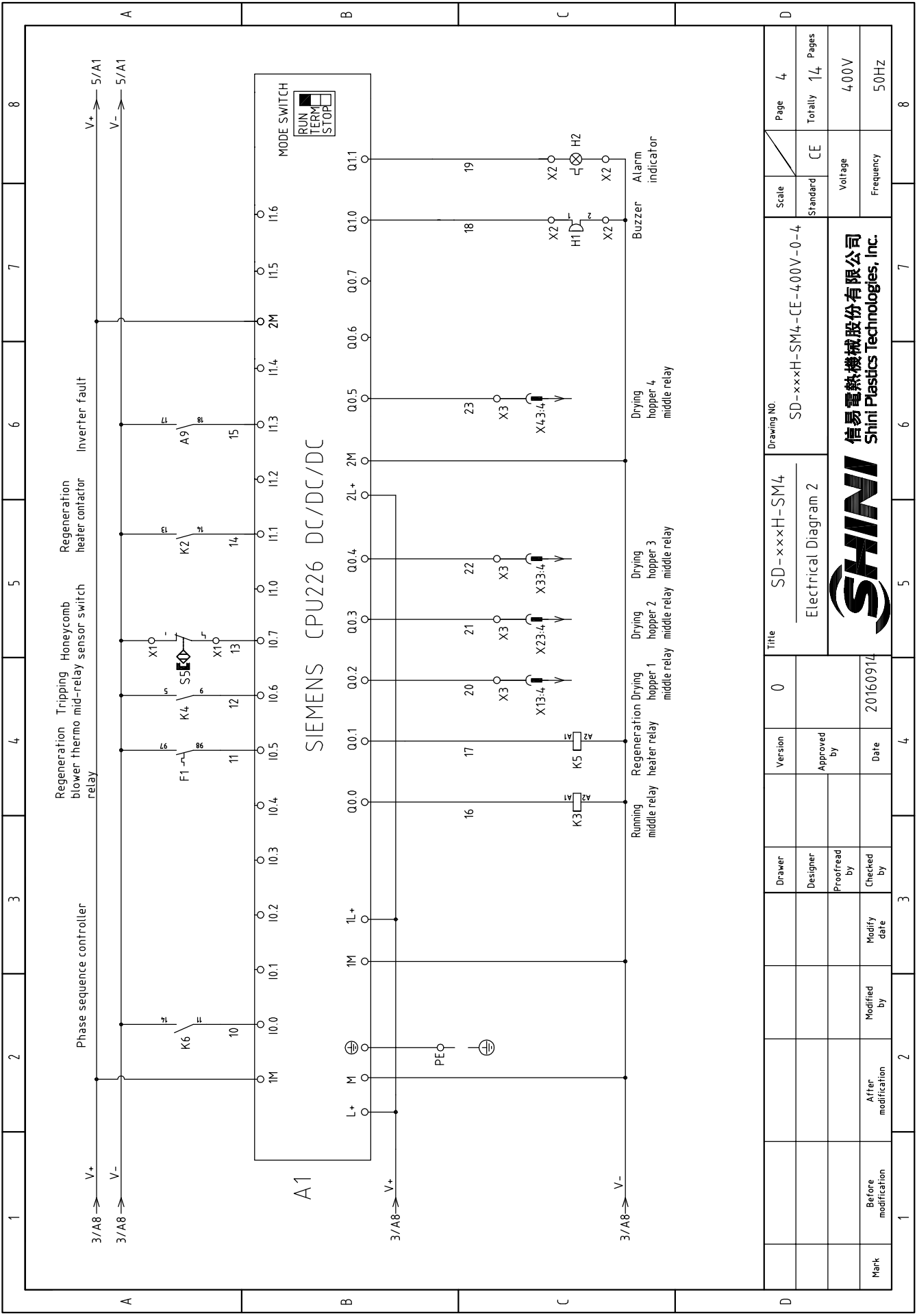

1	2	3	4	5	6	7	8
Version		0		Title		SD-xxxH-SM4	
Designer		Approved by		Drawing NO.		SD-xxxH-SM4-CE-400V-0-4	
Proofread by		Checked by		Electrical Diagram 2		Scale	
Modified by		Modify date		SHINI		Standard	
Before modification		Date		信易電熱機械股份有限公司		Voltage	
Mark		20160914		Shini Plastics Technologies, Inc.		Frequency	
		4		5		400V	
		3		6		50HZ	
		4		7		Page	
		4		8		Totally	
		4		8		Pages	

4/A8 → V+ V- 6/A1 6/A1

A2

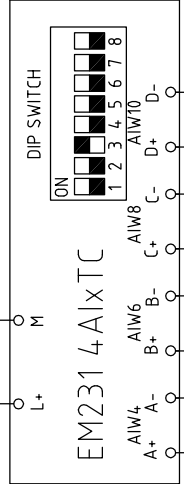

A3

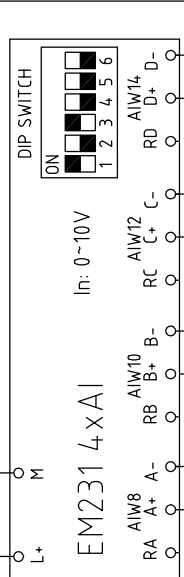

A4

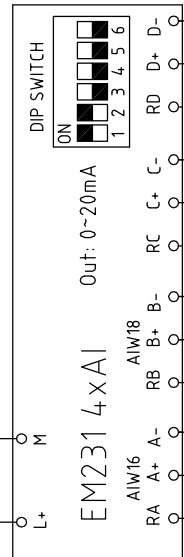

Regeneration temp. detection thermocouple

Return air temp. detection thermocouple

Dew-point transducer

1	2	3	4	5	6	7	8
Title		SD-xxH-SM4		SD-xxH-SM4-CE-400V-0-5		Page 5	
Version		0		Standard		CE	
Electrical Diagram 3		SHINI		Voltage		400V	
Date		20160914		Frequency		50HZ	
Total		14		Pages		14	
Total		5		Voltage		400V	
Total		8		Frequency		50HZ	

信易電熱機械股份有限公司
 Shini Plastics Technologies, Inc.



SHINI

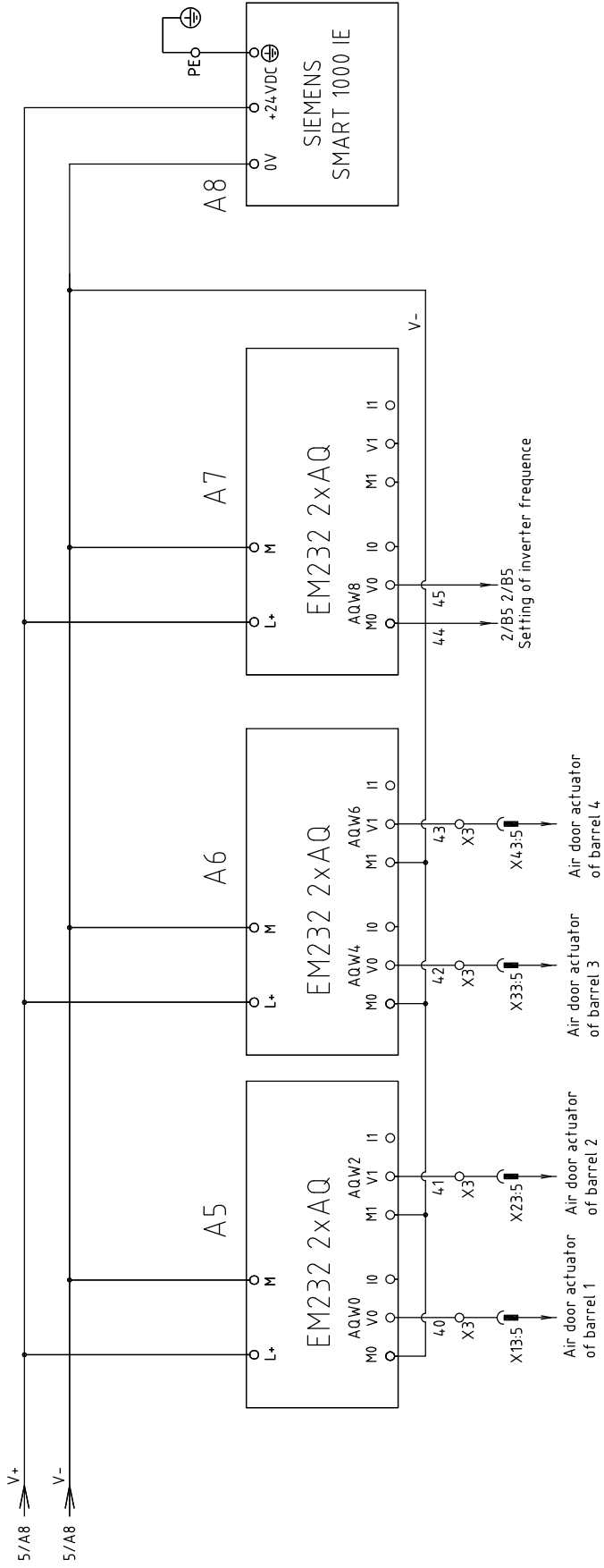

1	2	3	4	5	6	7	8
Mark		Before modification	After modification	Modified by	Modify date	Checked by	Date
Designer		Proofread by	Approved by	Version	0	Title	SD-xxxH-SM4
Scale		Standard	CE	Drawing NO.		SD-xxxH-SM4-CE-400V-0-6	
Frequency		50HZ	Voltage		400V		
Page		6		Totally		14 Pages	



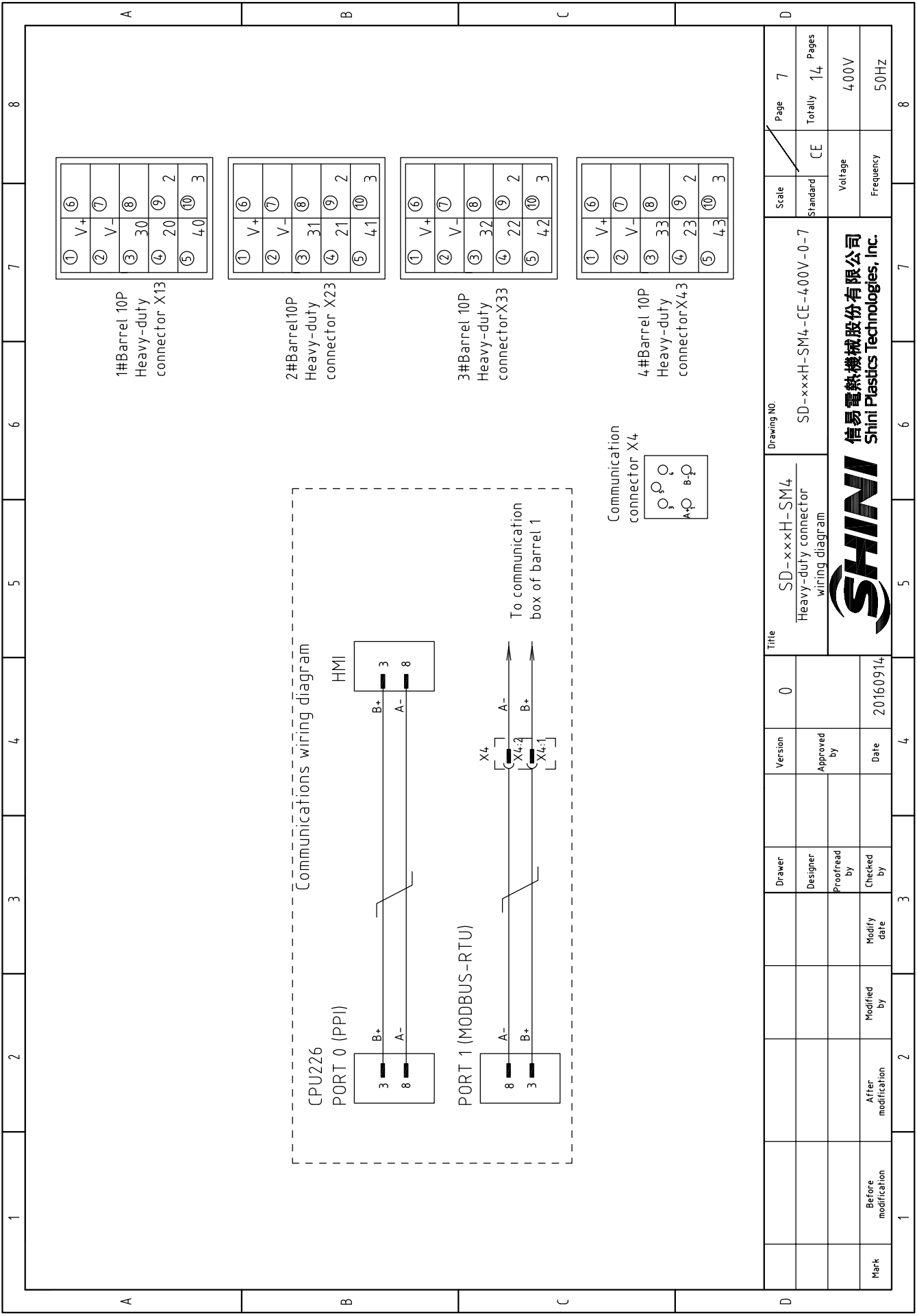

①	V+	⑥
②	V-	⑦
③	30	⑧
④	20	⑨
⑤	40	⑩
		3

1#Barrel 10P Heavy-duty connector X13

①	V+	⑥
②	V-	⑦
③	31	⑧
④	21	⑨
⑤	41	⑩
		2

2#Barrel10P Heavy-duty connector X23

①	V+	⑥
②	V-	⑦
③	32	⑧
④	22	⑨
⑤	42	⑩
		2

3#Barrel 10P Heavy-duty connector X33

①	V+	⑥
②	V-	⑦
③	33	⑧
④	23	⑨
⑤	43	⑩
		2

4#Barrel 10P Heavy-duty connector X43

Communication connector X4



Mark	Before modification	Modified by	Date	Version	Title	Drawing NO.	Scale	Page
	After modification	Modified by	Date					Totally
			20160914	0	SD-xxxH-SM4 Heavy-duty connector wiring diagram	SD-xxxH-SM4-CE-400V-0-7	Standard	7
							CE	14
							Voltage	400V
							Frequency	50HZ
								8



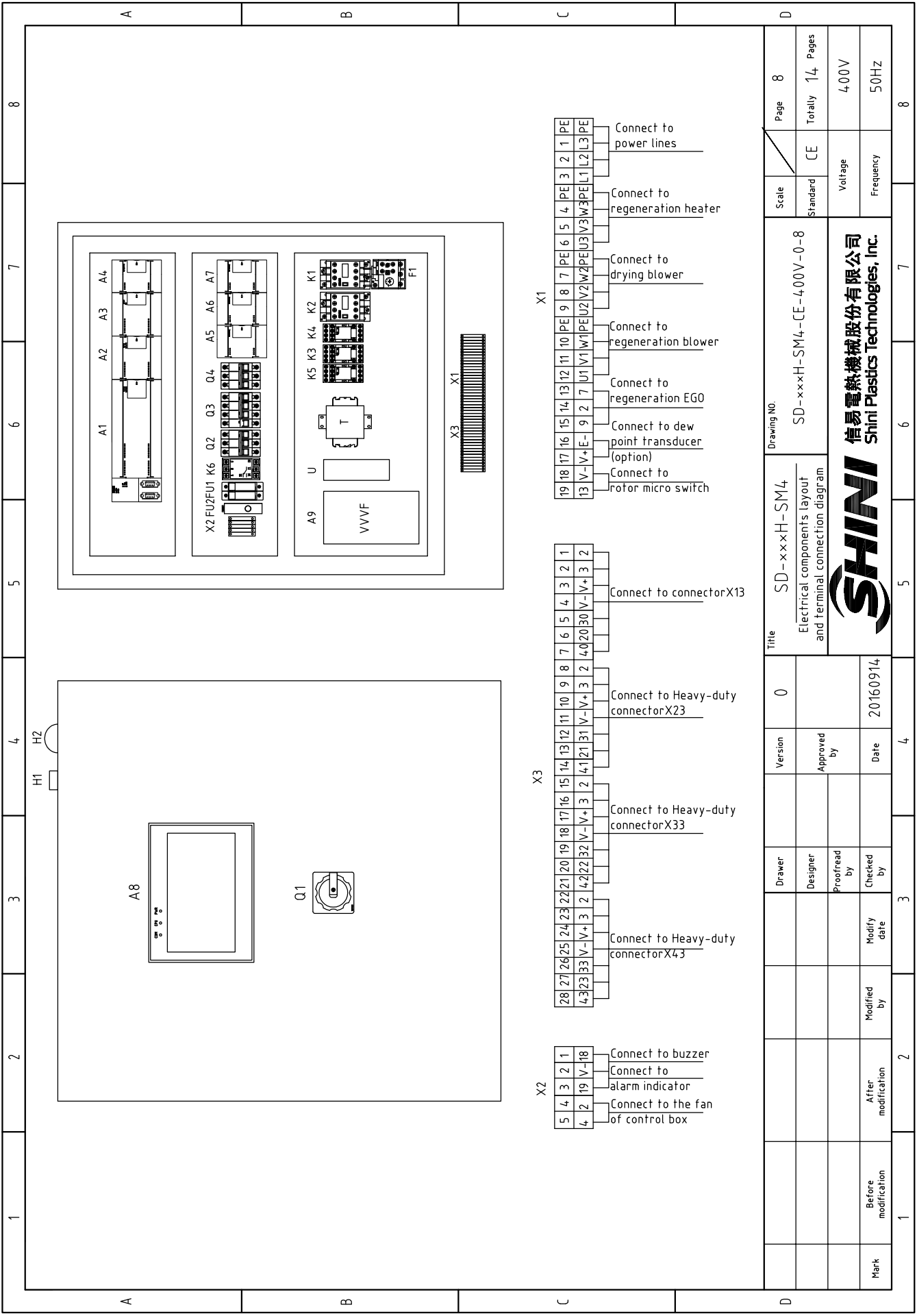

Mark	Before modification	Modified by	Modify date	Date	20160914	Approved by	Version	0	Title	SD-xxxH-SM4		Drawing NO.	Scale	Page	8
	After modification	Checked by	Proofread by							Designer	Drawer			Electrical components layout and terminal connection diagram	
													Voltage	400V	
													Frequency	50HZ	
													SD-xxxH-SM4-CE-400V-0-8		
													SHINI		
													信易電熱機械股份有限公司 Shini Plastics Technologies, Inc.		
1	2	3	4	5	6	7	8								

1		2		3		4		5		6		7		8	
NO.	Symbol	Name	Manufacturer	Type	Specification	Number	Material number	Remark							
1	Q1	Main Switch	MOELLER	TO-2-1/EA/SVB	16A	1	YE10021160000								
2	Q2	Circuit breaker	TECO	BM-63C/3010S	10A	1	YE40301003000								
3	Q3 Q4	Circuit breaker	TECO	BM-63C/3010S	10A	2	YE40301003000								
4		Release	CHINT	MX	----	1	YE40023560000								
5	K1	Contactors	SIEMENS	3RT6016-1AN21	220V 50/60Hz	1	YE00601621000								
6	K2	Contactors	SIEMENS	3RT6017-1AN21	220V 50/60Hz	1	YE00601721000								
7	K3 K5	Middle relay	WEIDMULLER	DRM270024LT	24V	2	YE03272400000								
8	K6	Phase sequence protector	CHAOSHI	ABJ-10W	400V 50/60Hz	1	YE03103800000								
9	K4	Middle relay	WEIDMULLER	DRM270730LT	230V 50/60Hz	1	YE03270700000								
10	F1	Thermo overload relays	SIEMENS	3RU6116-1AB0	1.1-1.6A	1	YE01160110000								
11	FU1	Fuse	CHINT	CHINT/32A/2P	32A/2P	1	YE41032200000								
12		Fuse core	MRO	MRO/2A 500V	2A	2	YE46002000100								
13	FU2 FU3	Fuse	YINDA	FS-10	2A	2	YE41001000000								
14	T	Transformer	BAIYUN	IN=400V OUT=230V	1000mA	1	YE70402300000								
15	A1	PLC	SIEMENS	S7-200	CPU226 CN DC/DC/DC	1	YE81022640000								
16	A2	Expansion module	SIEMENS	EM231X TC	24VDC	1	YE82023100100								
17	A3 A4	Expansion module	SIEMENS	EM231 X AI	24VDC	2	YE82023100000								
18	A5 A6 A7	Expansion module	SIEMENS	EM232X AQ	24VDC	3	YE82023200000								
19		Expansion cable	SIEMENS	----	----	1	YE90729000000								
20	A8	HMI	SIEMENS	SMART 1000	24VDC	1	YE80024000000								
21	A9	Frequency converter	ABB	ACS355-03E-02A4-4	400V 0.75KW	1	YE75350300000								
22		Inverter controller	ABB	J404	----	1	YE81040400000								
23	U	DC Power	MEAN WELL	NES-100-24	OUT=DC24V 4.5A	1	YE71102400000								
24	S4	Temperature protector	TONGBAO	WR-A-50-300-1000-3	250V 5(4)A	1	YE21503000100	(1)							
25	S5	Sensor switch	----	----	----	1	----	(1)							

机型版本 Ver.B Notes: (1)Means it's not the material inside the control box. (2)Means optional item.

D		Drawing NO.		Scale		Page	
		SD-120H-SM4		SD-xxH-SM4-CE-400V-0-9		Page 9	
		Electrical Components List 1		Standard		Totally 14 Pages	
				Voltage		400V	
				Frequency		50Hz	
Mark		Before modification		Modified by		Modify date	
						20160914	
		Designer		Approved by		Date	
		Proofread by		Version		0	
		Checked by		Title		SD-120H-SM4	
				Electrical Components List 1			
		Checked by		Title		SD-xxH-SM4-CE-400V-0-9	
				Electrical Components List 1			
		Checked by		Title		SD-xxH-SM4-CE-400V-0-9	
				Electrical Components List 1			
		Checked by		Title		SD-xxH-SM4-CE-400V-0-9	
				Electrical Components List 1			
		Checked by		Title		SD-xxH-SM4-CE-400V-0-9	
				Electrical Components List 1			
		Checked by		Title		SD-xxH-SM4-CE-400V-0-9	
				Electrical Components List 1			
		Checked by		Title		SD-xxH-SM4-CE-400V-0-9	
				Electrical Components List 1			
		Checked by		Title		SD-xxH-SM4-CE-400V-0-9	
				Electrical Components List 1			
		Checked by		Title		SD-xxH-SM4-CE-400V-0-9	
				Electrical Components List 1			
		Checked by		Title		SD-xxH-SM4-CE-400V-0-9	
				Electrical Components List 1			
		Checked by		Title		SD-xxH-SM4-CE-400V-0-9	
				Electrical Components List 1			
		Checked by		Title		SD-xxH-SM4-CE-400V-0-9	
				Electrical Components List 1			
		Checked by		Title		SD-xxH-SM4-CE-400V-0-9	
				Electrical Components List 1			
		Checked by		Title		SD-xxH-SM4-CE-400V-0-9	
				Electrical Components List 1			
		Checked by		Title		SD-xxH-SM4-CE-400V-0-9	
				Electrical Components List 1			
		Checked by		Title		SD-xxH-SM4-CE-400V-0-9	
				Electrical Components List 1			
		Checked by		Title		SD-xxH-SM4-CE-400V-0-9	
				Electrical Components List 1			
		Checked by		Title		SD-xxH-SM4-CE-400V-0-9	
				Electrical Components List 1			
		Checked by		Title		SD-xxH-SM4-CE-400V-0-9	
				Electrical Components List 1			
		Checked by		Title		SD-xxH-SM4-CE-400V-0-9	
				Electrical Components List 1			
		Checked by		Title		SD-xxH-SM4-CE-400V-0-9	
				Electrical Components List 1			
		Checked by		Title		SD-xxH-SM4-CE-400V-0-9	
				Electrical Components List 1			
		Checked by		Title		SD-xxH-SM4-CE-400V-0-9	
				Electrical Components List 1			
		Checked by		Title		SD-xxH-SM4-CE-400V-0-9	
				Electrical Components List 1			
		Checked by		Title		SD-xxH-SM4-CE-400V-0-9	
				Electrical Components List 1			
		Checked by		Title		SD-xxH-SM4-CE-400V-0-9	
				Electrical Components List 1			
		Checked by		Title		SD-xxH-SM4-CE-400V-0-9	
				Electrical Components List 1			
		Checked by		Title		SD-xxH-SM4-CE-400V-0-9	
				Electrical Components List 1			
		Checked by		Title		SD-xxH-SM4-CE-400V-0-9	
				Electrical Components List 1			
		Checked by		Title		SD-xxH-SM4-CE-400V-0-9	
				Electrical Components List 1			
		Checked by		Title		SD-xxH-SM4-CE-400V-0-9	
				Electrical Components List 1			
		Checked by		Title		SD-xxH-SM4-CE-400V-0-9	
				Electrical Components List 1			
		Checked by		Title		SD-xxH-SM4-CE-400V-0-9	
				Electrical Components List 1			
		Checked by		Title		SD-xxH-SM4-CE-400V-0-9	
				Electrical Components List 1			
		Checked by		Title		SD-xxH-SM4-CE-400V-0-9	
				Electrical Components List 1			
		Checked by		Title		SD-xxH-SM4-CE-400V-0-9	
				Electrical Components List 1			
		Checked by		Title		SD-xxH-SM4-CE-400V-0-9	
				Electrical Components List 1			
		Checked by		Title		SD-xxH-SM4-CE-400V-0-9	
				Electrical Components List 1			
		Checked by		Title		SD-xxH-SM4-CE-400V-0-9	
				Electrical Components List 1			
		Checked by		Title		SD-xxH-SM4-CE-400V-0-9	
				Electrical Components List 1			
		Checked by		Title		SD-xxH-SM4-CE-400V-0-9	
				Electrical Components List 1			
		Checked by		Title		SD-xxH-SM4-CE-400V-0-9	
				Electrical Components List 1			
		Checked by		Title		SD-xxH-SM4-CE-400V-0-9	
				Electrical Components List 1			
		Checked by		Title		SD-xxH-SM4-CE-400V-0-9	
				Electrical Components List 1			
		Checked by		Title		SD-xxH-SM4-CE-400V-0-9	
				Electrical Components List 1			
		Checked by		Title		SD-xxH-SM4-CE-400V-0-9	
				Electrical Components List 1			
		Checked by		Title		SD-xxH-SM4-CE-400V-0-9	
				Electrical Components List 1			
		Checked by		Title		SD-xxH-SM4-CE-400V-0-9	
				Electrical Components List 1			
		Checked by		Title		SD-xxH-SM4-CE-400V-0-9	
				Electrical Components List 1			
		Checked by		Title		SD-xxH-SM4-CE-400V-0-9	
				Electrical Components List 1			
		Checked by		Title		SD-xxH-SM4-CE-400V-0-9	
				Electrical Components List 1			
		Checked by		Title		SD-xxH-SM4-CE-400V-0-9	
				Electrical Components List 1			
		Checked by		Title		SD-xxH-SM4-CE-400V-0-9	
				Electrical Components List 1			
		Checked by		Title		SD-xxH-SM4-CE-400V-0-9	
				Electrical Components List 1			
		Checked by		Title		SD-xxH-SM4-CE-400V-0-9	
				Electrical Components List 1			
		Checked by		Title		SD-xxH-SM4-CE-400V-0-9	
				Electrical Components List 1			
		Checked by		Title		SD-xxH-SM4-CE-400V-0-9	
				Electrical Components List 1			
		Checked by		Title		SD-xxH-SM4-CE-400V-0-9	
				Electrical Components List 1			
		Checked by		Title		SD-xxH-SM4-CE-400V-0-9	
				Electrical Components List 1			
		Checked by		Title		SD-xxH-SM4-CE-400V-0-9	
				Electrical Components List 1			
		Checked by		Title		SD-xxH-SM4-CE-400V-0-9	
				Electrical Components List 1			
		Checked by		Title		SD-xxH-SM4-CE-400V-0-9	
				Electrical Components List 1			
		Checked by		Title		SD-xxH-SM4-CE-400V-0-9	
				Electrical Components List 1			
		Checked by		Title		SD-xxH-SM4-CE-400V-0-9	
				Electrical Components List 1			
		Checked by		Title		SD-xxH-SM4-CE-400V-0-9	
				Electrical Components List 1			
		Checked by		Title		SD-xxH-SM4-CE-400V-0-9	
				Electrical Components List 1			
		Checked by		Title		SD-xxH-SM4-CE-400V-0-9	
				Electrical Components List 1			
		Checked by		Title		SD-xxH-SM4-CE-400V-0-9	
				Electrical Components List 1			
		Checked by		Title		SD-xxH-SM4-CE-400V-0-9	
				Electrical Components List 1			
		Checked by		Title		SD-xxH-SM4-CE-400V-0-9	
				Electrical Components List 1			
		Checked by		Title		SD-xxH-SM4-CE-400V-0-9	
				Electrical Components List 1			
		Checked by		Title		SD-xxH-SM4-CE-400V-0-9	
				Electrical Components List 1			
		Checked by		Title		SD-xxH-SM4-CE-400V-0-9	
				Electrical Components List 1			
		Checked by		Title		SD-xxH-SM4-CE-400V-0-9	
				Electrical Components List 1			
		Checked by		Title		SD-xxH-SM4-CE-400V-0-9	
				Electrical Components List 1			
		Checked by		Title		SD-xxH-SM4-CE-400V-0-9	
				Electrical Components List 1			
		Checked by		Title		SD-xxH-SM4-CE-400V-0-9	
				Electrical Components List 1			
		Checked by		Title		SD-xxH-SM4-CE-400V-0-9	
				Electrical Components List 1			
		Checked by		Title		SD-xxH-SM4-CE-400V-0-9	
				Electrical Components List 1			
		Checked by		Title		SD-xxH-SM4-CE-400V-0-9	
				Electrical Components List 1			
		Checked by		Title		SD-xxH-SM4-CE-400V-0-9	
				Electrical Components List 1			
		Checked by		Title		SD-xxH-SM4-CE-400V-0-9	
				Electrical Components List 1			
		Checked by		Title		SD-xxH-SM4-CE-400V-0-9	
</							

1		2		3		4		5		6		7		8	
NO.	Symbol	Name	Manufacturer	Type	Specification	Number	Material number	Remark							
1	Q1	Main Switch	MOELLER	TO-2-1/EA/SVB	16A	1	YE10021160000								
2	Q2	Circuit breaker	TECO	BM-63C/30010S	10A	1	YE40301003000								
3	Q3	Circuit breaker	TECO	BM-63C/3010S	10A	1	YE40301003000								
4		Release	CHINT	MX	----	1	YE40023560000								
5	Q4	Circuit breaker	TECO	BM-63C/3010S	10A	1	YE40301003000								
6	K1	Contactors	SIEMENS	3RT16016-1AN21	220V 50/60Hz	1	YE00601621000								
7	K2	Contactors	SIEMENS	3RT16017-1AN21	220V 50/60Hz	1	YE00601721000								
8	K3 K5	Middle relay	WEIDMULLER	DRM270024LT	24V	2	YE03272400000								
9	K6	Phase sequence protector	CHAOSHI	ABJ-10W	400V 50/60Hz	1	YE03103800000								
10	K4	Middle relay	WEIDMULLER	DRM270730LT	230V 50/60Hz	1	YE03270700000								
11	F1	Thermo overload relays	SIEMENS	3RU6116-1AB0	1.1-1.6A	1	YE01160110000								
12	FU1	Fuse	CHINT	CHINT/32A/2P	32A/2P	1	YE41032200000								
13		Fuse core	MRO	MRO/2A 500V	2A	2	YE4602000100								
14	FU2 FU3	Fuse	YINDA	FS-10	2A	2	YE41001000000								
15	T	Transformer	BAIYUN	IN=400V OUT=230V	1000mA	1	YE70402300000								
16	A1	PLC	SIEMENS	S7-200	CPU226 CN DC/DC/DC	1	YE81022640000								
17	A2	Expansion module	SIEMENS	EM231X TC	24VDC	1	YE82023100100								
18	A3 A4	Expansion module	SIEMENS	EM231 X AI	24VDC	2	YE82023100000								
19	A5 A6 A7	Expansion module	SIEMENS	EM232X AQ	24VDC	3	YE82023200000								
20		Expansion cable	SIEMENS	----	----	1	YE90729000000								
21	A8	HMI	SIEMENS	SMART 1000	24VDC	1	YE80024000000								
22	A9	Frequency converter	ABB	ACS355-03E-04A1-4	400V 15kW	1	YE75350300100								
23		Inverter controller	ABB	J404	----	1	YE81040400000								
24	U	DC Power	MEAN WELL	S-35-24	OUT=DC24V 1.5A	1	YE71352400000								
25	S4	Temperature protector	TONGBAO	WR-A-50-300-1000-3	250V 5(4)A	1	YE21503000100	(1)							
机型版本 Ver.B															
Notes: (1)Means it's not the material inside the control box. (2)Means optional item.															
		Title		SD-200H-SM4		Drawing NO.		SD-xxH-SM4-CE-400V-0-11		Scale		Page		11	
		Electrical Components List 1								Standard		CE		Totally 14 Pages	
		Version		0		Approved by				Voltage		400V			
		Designer				Proofread by				Frequency		50Hz			
Mark		Before modification		Modified by		Modify date		20160816							
		Checked by				Date		20160816							
		Drawer				Version		0							
		Title		SD-200H-SM4		Drawing NO.		SD-xxH-SM4-CE-400V-0-11		Scale		Page		11	
		Electrical Components List 1								Standard		CE		Totally 14 Pages	
		Version		0		Approved by				Voltage		400V			
		Designer				Proofread by				Frequency		50Hz			
Mark		Before modification		Modified by		Modify date		20160816							
		Checked by				Date		20160816							
		Drawer				Version		0							



1		2		3		4		5		6		7		8	
NO.	Symbol	Name	Manufacturer	Type	Specification	Number	Material number	Remark							
1	Q1	Main Switch	MOELLER	TO-2-1/EA/SVB	25A	1	YE10125250000								
2	Q2	Circuit breaker	TECO	BM-63C/30016S	16A	1	YE40301603000								
3	Q3	Circuit breaker	TECO	BM-63C/3016S	16A	1	YE40301603000								
4		Release	CHINT	MX	----	1	YE40023560000								
5	Q4	Circuit breaker	TECO	BM-63C/3020S	20A	1	YE40302003000								
6	K1	Contactors	SIEMENS	3RT16016-1AN21	220V 50/60Hz	1	YE00601621000								
7	K2	Contactors	SIEMENS	3RT16026-1AN20	220V 50/60Hz	1	YE00602622000								
8	K3 K5	Middle relay	WEIDMULLER	DRM270024LT	24V	2	YE03272400000								
9	K6	Phase sequence protector	CHAOSHI	ABJ-10W	400V 50/60Hz	1	YE03103800000								
10	K4	Middle relay	WEIDMULLER	DRM270730LT	230V 50/60Hz	1	YE03270700000								
11	F1	Thermo overload relays	SIEMENS	3RU6116-1DB0	2.2-3.2A	1	YE01160220000								
12	FU1	Fuse	CHINT	CHINT/32A/2P	32A/2P	1	YE41032200000								
13		Fuse core	MRO	MRO/2A 500V	2A	2	YE4602000100								
14	FU2 FU3	Fuse	YINDA	FS-10	2A	2	YE41001000000								
15	T	Transformer	BAIYUN	IN=400V OUT=230V	1000mA	1	YE70402300000								
16	A1	PLC	SIEMENS	S7-200	CPU226 CN DC/DC/DC	1	YE81022640000								
17	A2	Expansion module	SIEMENS	EM231X TC	24VDC	1	YE82023100100								
18	A3 A4	Expansion module	SIEMENS	EM231 X AI	24VDC	2	YE82023100000								
19	A5 A6 A7	Expansion module	SIEMENS	EM232X AQ	24VDC	3	YE82023200000								
20		Expansion cable	SIEMENS	----	----	1	YE90729000000								
21	A8	HMI	SIEMENS	SMART 1000	24VDC	1	YE80024000000								
22	A9	Frequency converter	ABB	ACS355-03E-08A8-4	400V 4kW	1	YE75088400200								
23		Inverter controller	ABB	J404	----	1	YE81040400000								
24	U	DC Power	MEAN WELL	S-35-24	OUT=DC24V 1.5A	1	YE71352400000								
25	S4	Temperature protector	TONGBAO	WR-A-50-300-1000-3	250V 5(4)A	1	YE21503000100	(1)							
机型版本 Ver.A															
Notes: (1)Means it's not the material inside the control box. (2)Means optional item.															
D		Drawing NO.		Title		Version		Scale		Page		D			
		SD-4.00H-SM4		SD-4.00H-SM4		0		Standard		CE		Page 13		Totally 14 Pages	
		Electrical Components List 1		SD-xxH-SM4-CE-4.00V-0-13		Approved by		Voltage		Frequency		400V			
Mark		Before modification		Modified by		Modify date		Checked by		Date		50Hz			
						20160816									
1		2		3		4		5		6		7		8	



