

# **SIC-A-EB**

**Budget Air-cooled**

**Water Chiller**

Date: Sep. 2024

Version: Ver.C



## Contents

<b>1. General Description .....</b>	<b>5</b>
1.1 Coding Principle.....	6
1.2 Features.....	6
1.3 Technical Specifications .....	8
1.3.1 External Dimensions.....	8
1.3.2 Specification List.....	8
1.4 Safety Regulations.....	9
1.4.1 Security Labels.....	9
1.4.2 Signs and Labels.....	10
1.5 Exemption Clause.....	11
<b>2. Structural Features and Working Principle.....</b>	<b>12</b>
2.1 Main Functions.....	12
2.1.1 Working Principle.....	12
2.1.2 Main Parts and Functions.....	13
<b>3. Installation and Debugging .....</b>	<b>16</b>
3.1 Installation Notices.....	16
3.2 Schematic Drawing of Installation.....	17
<b>4. Application and Operation.....</b>	<b>19</b>
4.1 Control Panel .....	19
4.2 Machine startup .....	19
4.3 Common Screens .....	20
4.3.1 Main Screen .....	20
4.3.2 Alarm Screen.....	20
4.4 Common Operation.....	20
4.4.1 Quick Modification of Setting Temperature.....	20
4.4.2 Query/Reset Fault .....	20
4.4.3 Quick switching between Chinese/English .....	21
4.4.4 Change the language settings during power-on countdown.....	21
4.5 User Menu .....	21
4.6 Parameter Operation .....	21
4.7 Trouble-shooting Table .....	22
4.8 Machine Shutdown .....	27

<b>5. Maintenance and Repair .....</b>	<b>29</b>
5.1 Fill in the Refrigerant.....	31
5.2 Components Maintenance .....	32
5.2.1 Condenser.....	32
5.2.2 Evaporator.....	33
5.3 Maintenance Schedule .....	34
5.3.1 About the Machine.....	34
5.3.2 Check after Installation .....	34
5.3.3 Daily Checking .....	34
5.3.4 Weekly Checking.....	34
5.3.5 Montly Checking.....	34
5.3.6 Trimonthly Checking.....	34
5.3.7 Half-yearly Checking .....	34
5.3.8 Yearly Checking .....	35
5.3.9 3 year Checking .....	35

### Table Index

Table 1-1: Specifications .....	8
Table 1-2: Specification List .....	8
Table 5-1: Filling Quantity.....	32

### Picture Index

Picture 1-1: Budget Air-cooled Water Chiller SIC-10A-EB.....	5
Picture 1-2: Outline Dimensional Drawing .....	8
Picture 2-1: Working Principle .....	12
Picture 2-2: Compressor.....	13
Picture 2-3: Condensor.....	13
Picture 2-4: Drying Filter.....	14
Picture 2-5: Capillary or Thermal Expansion Valve.....	14
Picture 2-6: Evaporator.....	15
Picture 2-7: High and Low Pressure Controller .....	15
Picture 3-1: Installation Location .....	17

Picture 4-1: Control Panel .....	19
Picture 4-2: Stepup Step .....	19
Picture 5-1: Fill in the Refrigerant (1).....	31
Picture 5-2: Fill in the Refrigerant (2).....	32
Picture 5-3: Water Drainage Port .....	33

# 1. General Description



Please read through this operation manual before using and installation to avoid damage of the machine and personal injuries.

SIC-A-EB series are applicable for cooling molds to reduce products molding cycle, also they are available in the cooling of equipments in order to maintain a normal temperature. Besides, they are suitable for other industries with the need of cooling.



Picture 1-1: Budget Air-cooled Water Chiller SIC-10A-EB

## 1.1 Coding Principle

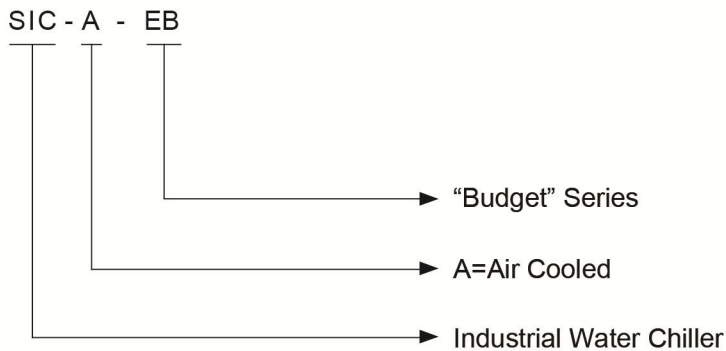

## 1.2 Features

- 1) Cooling range 7~25°C.
- 2) Stainless steel insulated water tank, with prolonged service life and free of contamination.
- 3) Adopt R410A refrigerant with good refrigeration effect.
- 4) Refrigerating system adopts multiple precise controls that accurately control the system stability.
- 5) Compressor and pump overload protection.
- 6) Fin-style condenser with quick heat conduction and good dissipation effect.
- 7) Adopt tube evaporator. The copper pipe is directly mounted on water tank that is economical and practical.
- 8) Adopt a microcomputer controller, with a accuracy of  $\pm 0.1$  °C;

All service work should be carried out by a person with technical training or corresponding professional experience. The manual contains instructions for both handling and servicing. Chapter 7, which contains service instructions intended for service engineers. Other chapters contain instructions for the daily operator.

Any modifications of the machine must be approved by SHINI in order to avoid personal injury and damage to machine. We shall not be liable for any damage caused by unauthorized change of the machine.

Our company provides excellent after-sales service. Should you have any problem during using the machine, please contact the company or the local vendor.

Shini Hotline Service:

Headquarter and Taipei factory:

Tel: + 886 (0)2 2680 9119

Shini Plastics Technologies (Dongguan), Inc.:

Tel: +86 (0)769 8331 3588

Shini Plastics Technologies (Pinghu), Inc.:

Tel: +86 (0)573 8522 5288

Shinden Precision Machinery (Chongqing), Inc.:

+86 (0)23 6431 0898

## 1.3 Technical Specifications

### 1.3.1 External Dimensions

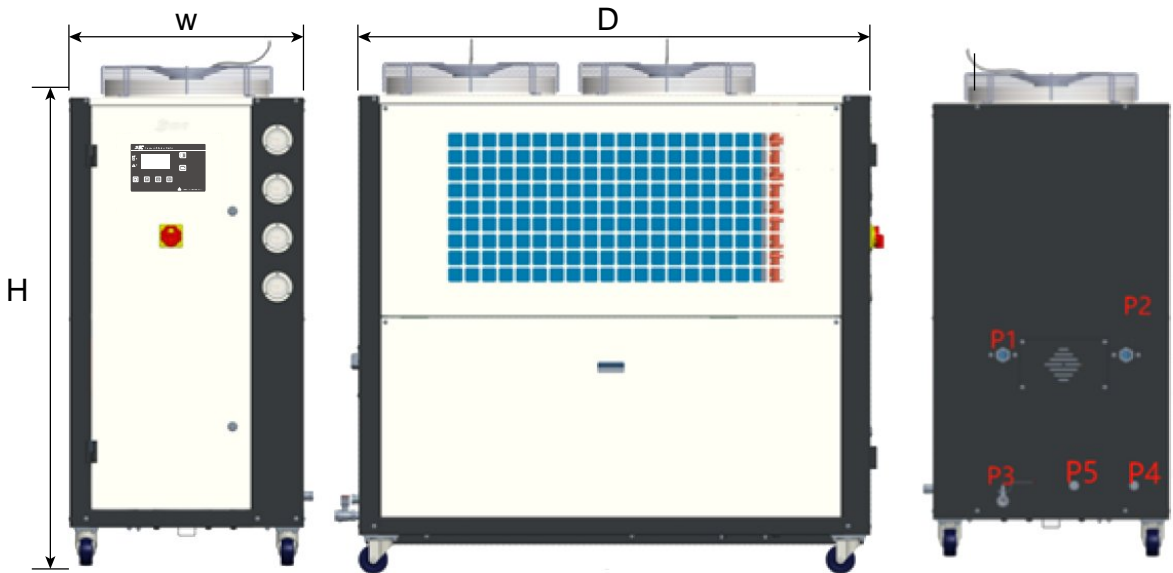

Picture 1-2: Outline Dimensional Drawing

Table 1-1: Specifications

Model	H	W	D	P1	P2	P3	P4	P5	Weight
	(mm)	(mm)	(mm)	Chilled Water Inlet (inch)	Chilled Water Outlet (inch)	Water Tank Outfall (inch)	Water Tank Overfall (inch)	Water Tank Refill Port (inch)	(kg)
SIC-5A-EB	1265	661	1344	1"	1"	1/2"	1/2"	1/2"	240
SIC-10A-EB	1430	697	1490	1"	1"	1/2"	1/2"	1/2"	310
SCI-15A-EB	1650	931	1853	1.5"	1.5"	1/2"	1/2"	1/2"	420

### 1.3.2 Specification List

Table 1-2: Specification List

Model		SIC-5A-EB	SIC-10A-EB	SIC-15A-EB
Refrigerant capacity	kW	10	20	30
	Kcal/hr	8,600	17,200	25800
Compressor	Type	Scroll		
	Output Power kW	2.9	5.8	13.3
Refrigerant	Filling volume(kg)	7.5	15	11



	Control mode	Capillary pipe		Expansion valve
	Type	R410		
Evaporator	Type	Tube style		
Condenser	Type	Fin style		
	Blower power(kW)	0.19x2	0.25x2	0.8*2
Water tank capacity(L)		55	145	161
Water pump(50HZ)	Power (kWw)	0.37	0.75	1.5
	Pump flow(L/min)	60		133
	Working pressure (kgf/cm <sup>2</sup> )	2		3
Total power (kw)		3.65	7.05	16.4
Pipe coupling ( inch )	Chilled water outlet	1"		1.5"
	Chilled water inlet	1"		1.5"
	Water tank drainage Port	1/2"		
	Water tank overflow Port	1/2"		
Protective devices	Compressor	Built-in protective switch/Overload relay		
	Pump	Overload relay		
	Refrigeration loop	High and low pressure controller		
Power		3Φ, 400VAC, 50Hz		
Measures exchange		1KW=860kcal/hr 1RT=3,024kcal/hr 10.000Btu/hr=2,520kcal/hr		

Note:

- 1) The refrigeration capacity is measured based on the outlet temperature (20℃) of chilled water under the environment temperature of 35℃.
- 2) Special orders of machine voltage can be acceptable according to customers's request.

## 1.4 Safety Regulations

The user must conform to the following safety rules when operating the machine.

### 1.4.1 Security Labels



Attention!

Installation of the device is allowed only to the professional electrician. Before maintaining and repairing the device, be sure to turn off the main switch and control switch.



Warning! High Voltage!

This label is posted on enclosure of the electrical control cabinet!



Warning! Be careful!

Pay more attentions at the places where this sign is attached!



Attention!

Drain the water inside when power off at the cold day to avoid freezing!







Attention!

No need for regular inspection because all the electrical parts in the control unit are fixed tightly!

#### 1.4.2 Signs and Labels

	<p>This is for indicating motor rotating direction.</p> <p>When phase reversal happens, the alarm sounds and indicator on control panel will indicate. Please exchange the place of the two electrical wires to solve this problem.</p>
	<p>Pump pressure gauge: display actual pressure of cold water system.</p>
	<p>High pressure gauge: display pressure in the high-pressure side of refrigerant system.</p>
	<p>Low pressure gauge: display pressure in the low-pressure side of refrigerant system.</p>
	<p>Chilled Water Return(From Mould)</p>

	Chilled Water Outlet (To Mould)
	Water Supply Inlet
	Drain
	Overflow

### 1.5 Exemption Clause

The following statements clarify the responsibilities and regulations born by any buyer or user who purchases products and accessories from Shini (including employees and agents).

Shini is exempted from liability for any costs, fees, claims and losses caused by reasons below:

1. Any careless or man-made installations, operation and maintenances upon machines without referring to the Manual prior to machine using.
2. Any incidents beyond human reasonable controls, which include man-made vicious or deliberate damages or abnormal power, and machine faults caused by irresistible natural disasters including fire, flood, storm and earthquake.
3. Any operational actions that are not authorized by Shini upon machine, including adding or replacing accessories, dismantling, delivering or repairing.
4. Employing consumables or oil media that are not appointed by Shini.

## 2. Structural Features and Working Principle

### 2.1 Main Functions

SIC-A-EB Budget Air-cooled Water Chiller is constituted by 4 parts: compressor, condenser, capillaries and tube evaporator. It adopts the single-stage vapour compression refrigeration system and obtains the refrigerating effect by refrigerant gas-liquid transformation and heat absorption and release principle.

#### 2.1.1 Working Principle

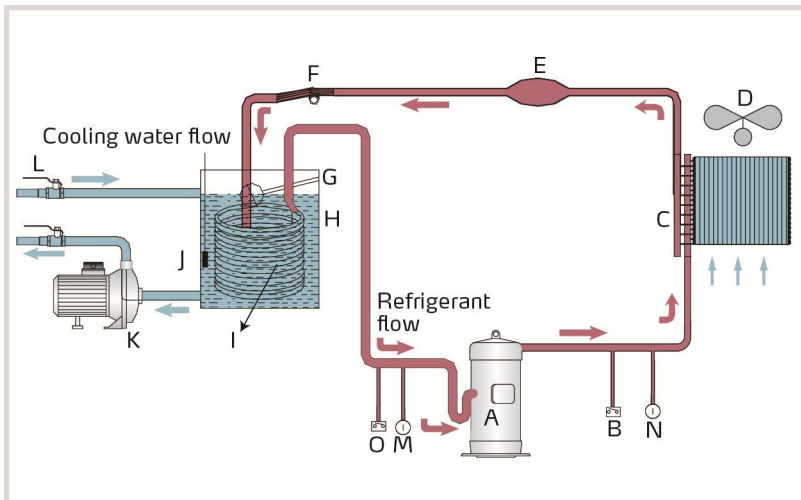

Picture 2-1: Working Principle

Parts name:

- |                        |                              |                            |
|------------------------|------------------------------|----------------------------|
| A. Compressor          | B. High- pressure controller | C. Fin type condenser      |
| D. Fan                 | E. Drying filter             | F. Castanding poley        |
| G. Floating-ball valve | H. Water tank                | I. Evaporator              |
| J. Thermocouple        | K. Pump                      | L. Ball valve              |
| M. Low pressure gauge  | N. High pressure gauge       | O. Low pressure controller |

When SIC-A-EB air-cooled water chiller starting up, compressor (A) starts working. Refrigerant is compressed into high temperature high pressure gas, and then be cooled when passing through condenser (C) and changed into liquid. Heat is taken away by the cooling air. The liquid high pressure refrigerant passes through the castanding poley (F), and partial refrigerant is changed into gas under reduced pressure. At this time, the refrigerant is mixed with gas and liquid, which cools down the chilled water into required temperature after passing through the

tube evaporator (I). By heat adsorption, the liquid refrigerant changes to gas and returns the compressor for this circulation.

## 2.1.2 Main Parts and Functions

### 2.1.2.1 Compressor

- 1) Compressing and conveying the refrigeration steam and forming low pressure in evaporator and high pressure in condenser, the compressor is the core of the whole system.
- 2) SIC-A-EB adopts scroll compressor.



Picture 2-2: Compressor

### 2.1.2.2 Condensor

- 1) Condenser is a heat output device which is used to discharge the heat absorbed by the evaporator and converted by the compressor to the cooling medium.
- 2) SIC-A-EB adopts fin-style condenser.



Picture 2-3: Condensor

### 2.1.2.3 Drying Filter

- 1) The functions of the dry filter are: clean the impurity in the refrigerant, absorb the free moisture in the refrigerant, and prevent the narrow section (especially the valve port of the heat expansion valve) of the pipe from forming ice jam.

- 2) The size of the filter is usually chosen according to the caliber of the cooling agent pipe.



Picture 2-4: Drying Filter

#### 2.1.2.4 Capillary or Thermal Expansion Value

- 1) The capillary or the thermal expansion valve throttles the refrigerant and reduces the pressure of it, as well as regulate the refrigerant flow which enters the evaporator.
- 2) Install it in front of the evaporator.



Picture 2-5: Capillary or Thermal Expansion Valve

#### 2.1.2.5 Evaporator

- 1) The evaporator is a device that outputs the refrigerant, which absorbs the heat of the cooled object in the evaporator, so as to achieve the refrigerating purpose.
- 2) Our company uses the tube evaporator.



Picture 2-6: Evaporator

#### 2.1.2.6 High and Low Pressure Controller

- 1) The high and low pressure controller is used to check the working pressure of the compressor's inlet and outlet.
- 2) The high-pressure controller is set to 37bar, and the low-pressure controller is set to 4bar.
- 3) It will give the alarm when the compressor outlet air pressure is higher than 37bar, or the compressor inlet air pressure is lower than 4bar.



Picture 2-7: High and Low Pressure Controller

### 3. Installation and Debugging



Attention!

Read this chapter before installation. Install the machine according to following steps!

Air-cooled water chiller should be installed in an environment that has good ventilation, such as draughty area near the window. Ambient temperature should not be more than 43°C if it is installed indoors. Use ventilator or exhaust pipe to conduct the hot air produced by the chiller to the outside. If the chiller is installed outdoors, protective cover should be used.

#### 3.1 Installation Notices

- 1) Make sure that the voltage and frequency corresponds with the requirements on manufacturer's name plate.
- 2) Connection of the machine electrical wires and negative wire according to local rules and regulations.
- 3) Use independent electrical wires and switch. Diameter of electrical wire should not be smaller than that of the electric wire which is used for the electrical control box.
- 4) Wiring connections should be firmly fixed.
- 5) This series of water chillers adopts the three-phase five-wire power supply, which is connected to the live wire, (N) to the neutral wire, and (G) to the ground wire.
- 6) Power supply:  
Voltage deviation: Rated voltage on the nameplate:  $\pm 5\%$   
Frequency deviation:  $\pm 2\%$
- 7) ***Please refer to electrical drawing of each model to get the detailed power supply specifications***



Electrical wire connection of water chiller should be done by qualified electrician!

Electrical wiring circuit should not be modified unless authorized by our company. We shall not be reliable for machine damages caused by unauthorized



modification.



Attention!

Before connecting the machine with power supply, please make sure that main switch is turned off!

### 3.2 Schematic Drawing of Installation

- 1) Install the pipe system according to the installation and wiring diagram. Use heat insulating material to achieve heat preservation of chilled water pipe.
- 2) The pipe diameter of circulation pump should be no less than condenser adapter tube. (The in-and-out pipe system should be installed according to the wiring diagram). It should use large diameter pipes to connect the cooling water during long distance conveying.
- 3) Mount the water discharge valve at the lowest point of chilling water circulation system.
- 4) When water quality and environment around cooling tower is poor, the cooling water and chilling water circulation loop must be mounted with filter for regular cleaning.
- 5) Test if the pipe has leakage after installation. The chilling water circulation loop must be wrapped with insulation layer in case of heat loss and water leakage.

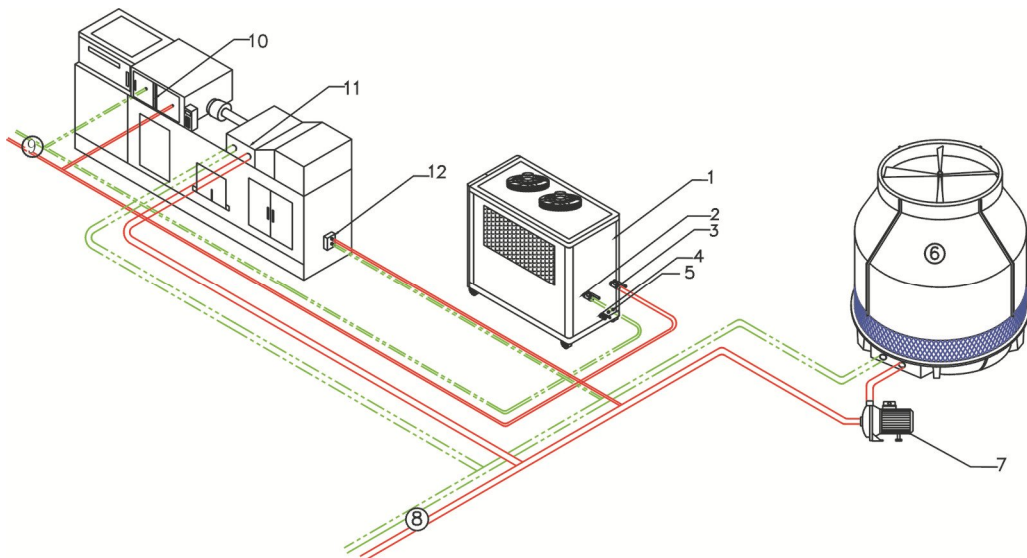

Picture 3-1: Installation Location

Parts Name :

- |                              |                              |                        |
|------------------------------|------------------------------|------------------------|
| 1. Water chiller             | 2. Chilled water outlet      | 3. Chilled water inlet |
| 4. Water drainage port       | 5. Water refill port         | 6. Cooling water tower |
| 7. Cooling water pump        | 8. Cooling water circulation |                        |
| 9. Chilled water circulation | 10. Mould Cooling            | 11. Cooling tank       |
| 12. Oil Cooling              |                              |                        |

## 4. Application and Operation

### 4.1 Control Panel

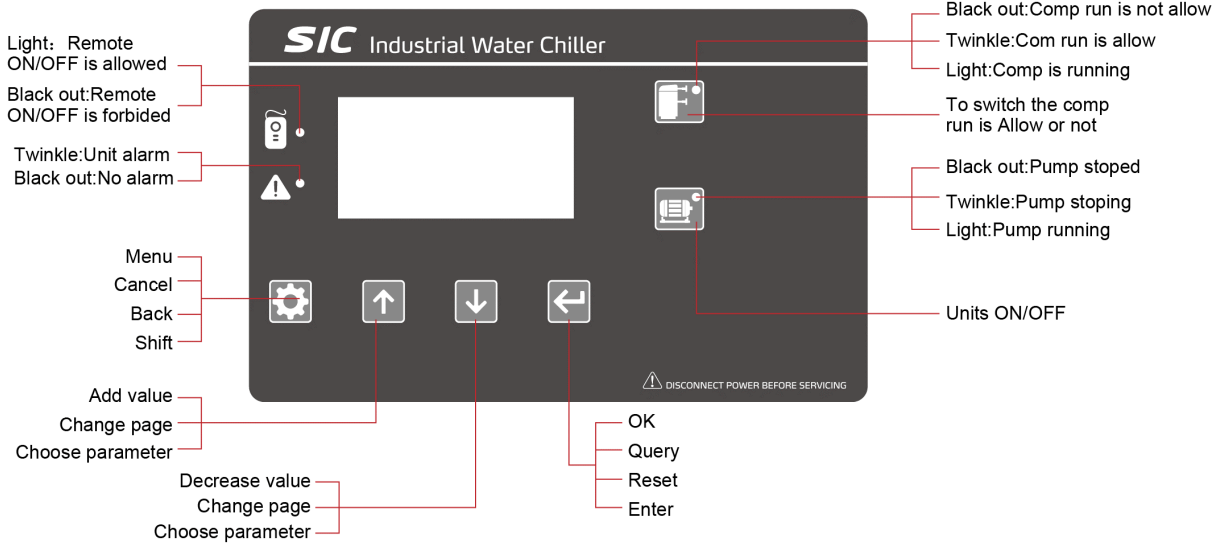

Picture 4-1: Control Panel

### 4.2 Machine startup

- 1) Turn on the main switch.

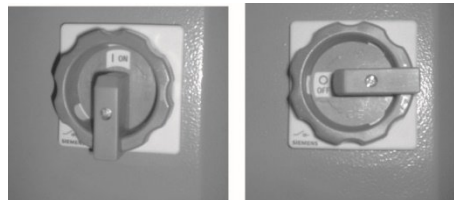

ON

OFF

Picture 4-2: Stepup Step

- 2) Turn on the pump.

Noets:

- a) When the operation pressure is lower than the values in the table above, the motor of the pump may be damaged because of large water flow.
  - b) When the operation pressure is higher than the vauces in the table above, the water flow may be insufficient and the machine may need a pump replacement to ensure high pressure.
- 3) Set chilling water temperature (Neglect this step if temperature is already set). Setting details please refer to 4.4 Chapter Temperature Controller.

For this series of water chiller, lowest process temperature should be set as 7°C.

- 4) Turn on the compressor.

### 4.3 Common Screens

Commonly used screens include the main screen and the alarm screen.

#### 4.3.1 Main Screen

The system will enter the main screen after countdown, which displays as follows:

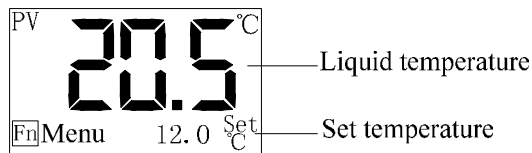

#### 4.3.2 Alarm Screen

In case of unit failure, the alarm screen is as follows:

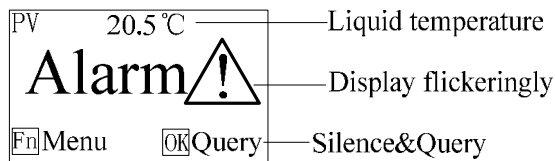

### 4.4 Common Operation

#### 4.4.1 Quick Modification of Setting Temperature

If the user parameter 【Lock Temp.】 is set to “No”, the setting temperature can be modified directly in the main screen, with operation details as follows:

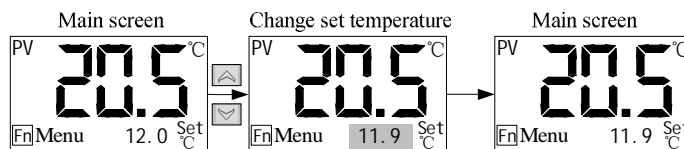

Note: The setting temperature can also be modified in the user parameters.

#### 4.4.2 Query/Reset Fault

In case of fault, the alarm screen will automatically pop up. The operation details of query and reset faults are as follows:

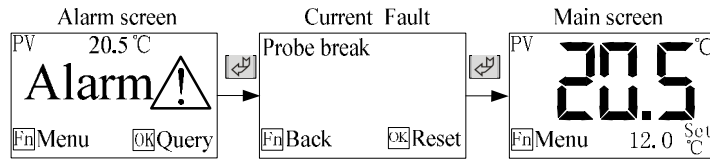

#### 4.4.3 Quick switching between Chinese/English

Press the and buttons for three seconds to switch the language.

#### 4.4.4 Change the language settings during power-on countdown

In the power-on countdown, press the and buttons to enter language setting screens, press the or buttons to change current language, press button to exit directly, and press to save and exit.

### 4.5 User Menu

Press the function on the main screen to enter the User Menu, which includes five items as the table below:

No.	Menu Item	Funtion	Remark
1	User Setting	To set the user parameters	Reference for the number and meaning of user parameters: 9 User Parameter Table
2	Unit Status	To display the current operating status of the unit	No display of current value when not using current module
3	History Fault	Allowing the query of the last 10 faults	Press  2s to clear the fault history.
4	Equipment Use Ratio	Display the cumulative run time of the compressor	
5	Version Info.	Query the current software version	

### 4.6 Parameter Operation

For the modification operation of parameter value, the user's modification of setting temperature will be described as an example. ( Select "No" for **Lock**

Temp.】).

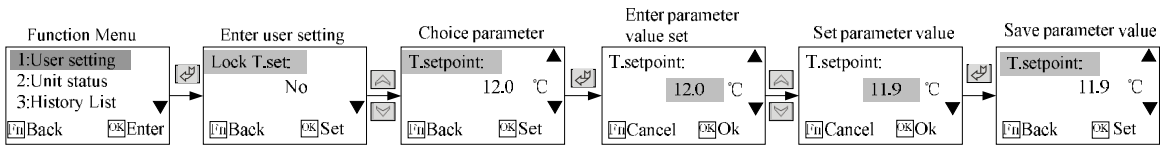

## 4.7 Troubleshooting Table

Fault	Test Conditions	Troubleshooting	Solution
1# Compressor high pressure	If the 【high pressure detection delay】 is 0, it detects when the compressor indicator flashes or lights up; If the 【high pressure detection delay】 is not 0, it detects after the 1# compressor runs the 【high pressure detection delay】		Check if the input is consistent with the switch setting.
1# Compressor low pressure	If the [LP Check Delay] is 0, test when the compressor indicator light flashes or lights up; If the [LP Check Delay] is not 0, 1# compressor runs the test.	Stop compressor 1# only without affect other equipments to work【 Note 1】.	
1# Compressor overload			Check if the input is consistent with the switch setting.
1# Compressor high current	1# Compressor runs the test		Check if the rated current of compressor is input reasonable.
1# Compressor low current			Check if current wiring of compressor is

			correct, and the interface is firm.
1# Exhaust temp. too high			Check if the input is consistent with the switch setting.
2# Compressor high pressure	If the [HP Check Delay] is 0, test when the compressor indicator light flashes or lights up; If the [HP Check Delay] is not 0, 2# compressor runs the test.	Stop compressor 2# only without affect other equipments to work【 Note 2】.	Check if the input is consistent with the switch setting.
2# Compressor low pressure	If the [LP Check Delay] is 0, test when the compressor indicator light flashes or lights up; If the [LP Check Delay] is not 0, 2# compressor runs the test.		
2# Compressor overload	2# Compressor runs the test		
2# Compressor high current			
2# Compressor low current			
2# Exhaust temp. too high			

Low temp.	Run the test	Stop the compressor and delay to stop the cooling pump, and do not stop the chilled pump.	The output water temp. Is lower than the set low temp. protection temp.
Over-temp. early warning		Alarm only without affect other equipments to work.	The output water temp. is higher than the overheat pre-warning temp.
Over-temp. Shutdown		If the [High temp. alarm] is set "pump keep", stop the compressor and delay to stop the cooling pump, and do not stop the chilled pump; If the [High temp. alarm] is set "pump stop", stop the unit in case of fault.	The output water temp. is higher than the set high temp. protection temp.
Anti-freeze Err	Power-on test	Stop the compressor and delay to stop the cooling pump, and do not stop the chilled pump.	Check if the anti-freezing input is consistent with the switch setting.
Water-temp. sensor breaks			Check if the temperature probe is in good contact.
Water-temp. sensor short circuit			
cooling pump overload <b>【Remark 3】</b>	Test after the cooling pump start	Stop the compressor and cooling pump, and do not stop the chilled pump.	Check if the cooling pump overload input is consistent with the switch setting.
Too high cooling current			Check if the rated current of cooling pump is set reasonably.
Low			Check if current



cooling current			wiring of cooling pump is correct, and the interface is firm.
Cooling waterflow fault	Test after the cooling pump start [cooling start delay] time		Check if the cooling water input is consistent with the switch setting.
Chilled waterflow fault	Test after the chilled pump start [chilled start delay] time	If the [Lack of water] is set "pump stop", stop the unit in case of fault. If the [Lack of water] is set "pump keep", stop the compressor and cooling pump in case of fault, and do not stop the chilled pump.	Check if the waterflow input is consistent with the switch setting.
Chilled water overload 【Remark 3】	Test after the chilled pump start	Stop the unit.	Check if the chilled overload input is consistent with the switch setting.
Chilled water high current			Check if the rated current of chilled pump is input reasonably.
Chilled water low current			Check if current wiring of chilled pump is correct, and the interface is firm.
3-phase power fault	Power-on test	Stop the unit.	Check if there is default phase or anti-phase in the three-phase power input and if the switch is correct.
Water level error	Power on to test, alarm	If the [Low water lv.] is set	Check if the water

	after detecting error continuously during [W.level stable] time.	“Pump stop”, stop the unit in case of fault. If the [Low water lv.] is set “Pump keep”, stop the compressor and cooling pump in case of fault, and do not stop chilled pump.	level input is consistent with the switch setting.
Machine needs maintenance	Run the test	The unit cannot start once stops (the accumulative operation time of compressor exceeds the set value).	
1# compressor low oil pressure	Compressor runs the test	Stop the compressor and delay to stop the cooling pump, and do not stop the chilled pump.	Check if the oil pressure switch input is consistent with the switching value setting.
2# compressor low oil pressure			
Need Maintenance	Power-on test	Alarm only without affect other equipments to work, can be reset.	

[Note 1]: In case of "1#Comp. P low " fault, if [LP stop pump] is not 0, the troubleshooting program is: to immediately stop all compressors and cooling pumps, delay the [LP stop pump] and stop the chilled pump. If [LP stop pump] is 0, then the troubleshooting program is: to only stop compressor1 without affect other equipments to work.

[Note 2]: In case of "2#Comp.P low " fault, the troubleshooting program is same as the method of "1#Comp.P low " fault, which is relevant to [LP stop pump] parameters.

[Note 3]: According to different models, displays of different chilled pump overload and cooling pump overload faults are as below:

Model	Screen Display when Chilled Pump Overload	Screen Display when Cooling Pump Overload
Air-cooled cooling water	Chilled pump overload	Cooling blower overload
Water-cooled cooling water	Chilled pump overload	Cooling pump overload

Air-cooled air	Conveying blower overload	Cooling blower overload
Water-cooled air	Conveying blower overload	Cooling pump overload



Attention!

Pump rotating direction should be correct.



Attention!

Before starting the system, make sure that cooling water pump is turned on. Check the water tank of the chiller. Do not start the machine when there is no water left in water tank. We shall not be liable for any damages caused by this reason.



Attention!

In order to reduce the possibilities of machine damage and prolong the life, start the machine with correct methods.



Attention!

Anti-freezing switch and high/low pressure controller have been set in the factory, which forbids random adjustment without the company's permission. Otherwise, we are not liable for the responsibility of any machine damage.



Attention!

The compressor can't be started frequently because of its characteristics (Frequent start will shorten its service life.). Therefore, the compressor will work about 3 minutes later after turning on the water pump. The parameter of temperature controller shall not be adjusted freely since it is already set.

## 4.8 Machine Shutdown

- 1) Turn off the compressor.

- 2) Turn off the pump. (Better to wait for 30 seconds after the compressor shutdown to ensure that the refrigerant in the evaporator is completely evaporated.)
- 3) Turn off the main switch.



Attention!

Avoid electrical shock when main switch is turned on.



Attention!

In order to reduce the possibilities of machine damage and prolong the life, shut off the machine with correct methods.

## 5. Maintenance and Repair

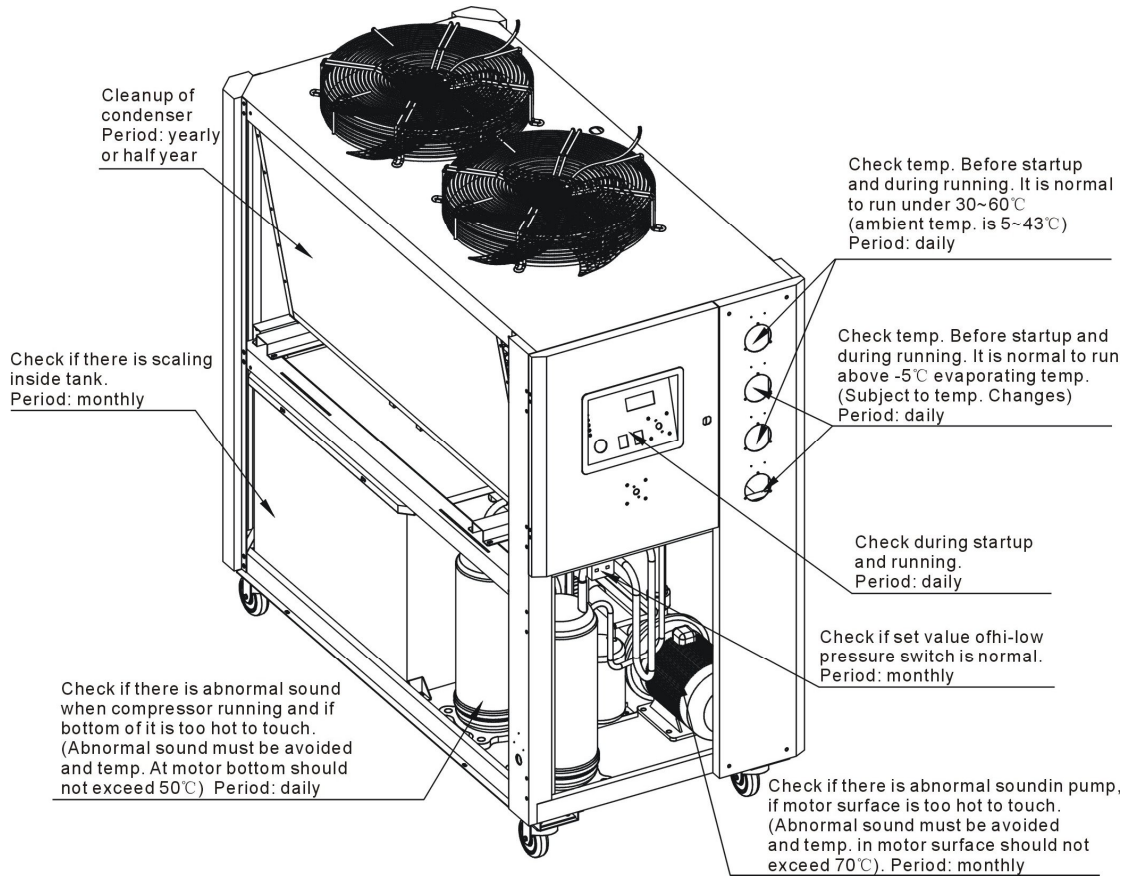

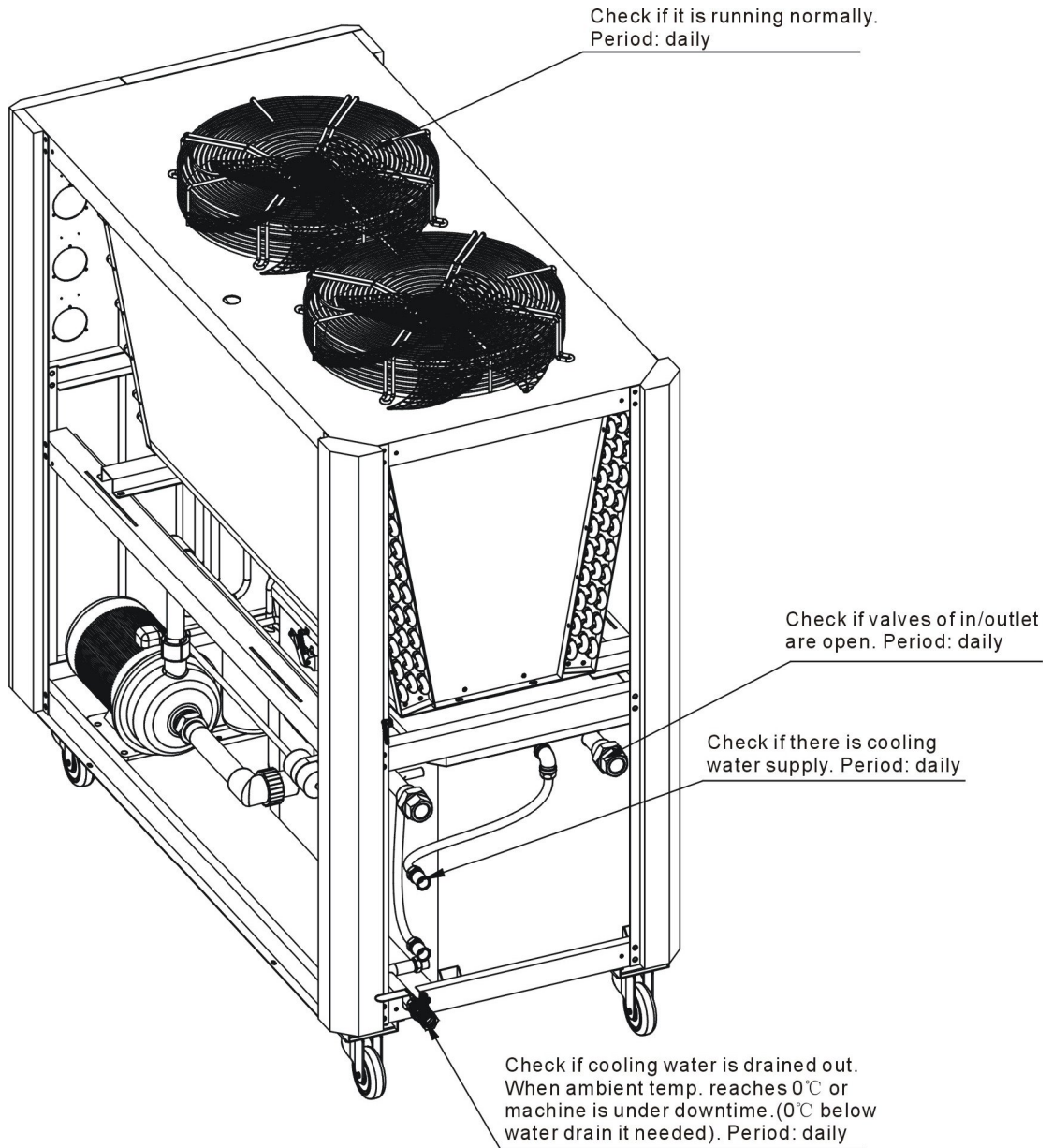

**Attention!**

All repair work should be done by qualified personnel only to avoid damage to the machine or personnel injury.

In order to operate the machine rightly and safely, please caution the matter follows:

- 1) Do not turn off the main power switch to stop the machine, except emergency situation.
- 2) When failures set in and the machine stop work with buzzer sound, first turn off the main power switch of the machine (alarm indicator will die), then go to check the reason of the failures, do not force the machine on before remove the failures.
- 3) Please check periodically to prolong the life of the machine and prevent the safety accident to appear.
- 4) Water supply should be processed, because the high PH can corrode the copper pipe acute. This must reduce the life of the heating and cooling implement, PH of the water supply must be between 7.0~8.5.
- 5) Keep the machine room dry, clean and draughty.
- 6) The operation and service of the machine should be done by qualified technician only.

(Please take notice that the disassembly and the inspection of the machines are hazardous when the machines are running!)

## 5.1 Fill in the Refrigerant

- 1) Screw off the end cap of the liquid filling thimble valve, and connect the air suction pipe of the vacuum pump to the liquid filling thimble valve to take the vacuum pumping, and this process may take one to two hours. The high & low pressure gauge display -76mmHg.

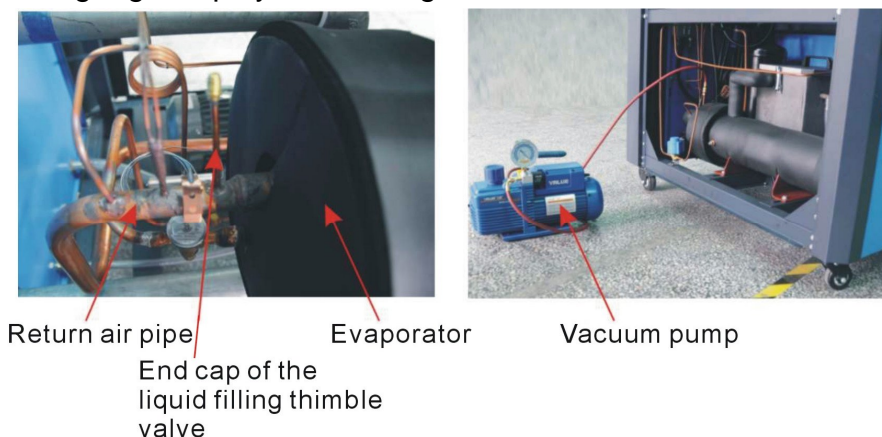

Picture 5-1: Fill in the Refrigerant (1)

2) After the vacuum pumping, connect the air pipe of the refrigerant tank to the liquid filling thimble valve, and fill the refrigerant into the air return pipe. Watch the change of the weight displayed by the electronic scale, and stop filling the refrigerant immediately when receiving the schedule weight. Make sure that the filling refrigerant must be liquid and be filled when the machine stops. In the condition of the starting up, the shown pressure of the high pressure gage should be about 29 to 31 bar; and shown pressure of the low pressure gage should be about 7 to 8 bar. (Note: the ambient temperature should be 35°C, and the temperature of the chilled water should be 12°C/7°C.)



Electronic scale      Refrigerant tank

Picture 5-2: Fill in the Refrigerant (2)

Table 5-1: Filling Quantity

Model	Filling Quantity of Refrigerant (kg)
SIC-5A-EB	3.5
SIC-10A-EB	5.0

## 5.2 Components Maintenance

### 5.2.1 Condenser

SIC-A-EB series water chiller use the air cooled fin style condenser which installed openly, in the using time, it is hard to avoid any dust and sundries, which will influence the heat emission effect, so it is necessary to clean the condenser at fixed periods in order to keep its working performance. Use brush, dust catcher or compressed air to clean the wings and copper pipe. Then use the low pressure water to cascade the tray pipe. Note: do not let the water to cascade on the surface of the fan motor.





Attention!

Do the cleaning work every half-year in the environment with little dust, but you must do the work every month in the environment with a great deal of dusts, and under the severe environment you had better see the situation to do the work.

### 5.2.2 Evaporator

The inner flank of the heat emission pipe will pile up a great deal of water incrustation after a long time use of the evaporator, which will influence the heat emission effect, so it is necessary to clean the evaporator at fixed periods in order to keep its working performance. If the circulation has been under water treatment, it is advised that firstly use hydrogen peroxide to kill bacteria and then use a high pressure water rifle to flush it, at last check whether there is still incrustation scale. If the circulation is not processed under water treatment, clean it with citric acid and sulfamic acid along with inhibitor, and then flush it with a high pressure water rifle. Passivation is need after acid washing, and the dirt will be discharged from the water outfall.



Attention!

Drain the water inside the evaporator and the condenser away when the machine stop running under 0°C.



Picture 5-3: Water Drainage Port

## 5.3 Maintenance Schedule

### 5.3.1 About the Machine

Model \_\_\_\_\_ SN \_\_\_\_\_ Production date \_\_\_\_\_

Voltage \_\_\_\_\_  $\Phi$  \_\_\_\_\_ V Frequency \_\_\_\_\_ Hz

Total power \_\_\_\_\_ kW

### 5.3.2 Check after Installation

- Check the pipes are all correctly connected.
- Check if there are leakages in the piping system.
- Check if there are breaks in welding joint.

#### Electrical Installation

- Voltage: \_\_\_\_\_ V \_\_\_\_\_ Hz
- Fuse specification: 1 Phase \_\_\_\_\_ A 3 Phase \_\_\_\_\_ A
- Check phase sequence of power supply.

### 5.3.3 Daily Checking

- Check switch functions.
- Check all the electrical wires.
- Check whether pressure gauges are accurate.
- Check whether compressor temperature is normal.
- Check whether cooling water circulation is normal.

### 5.3.4 Weekly Checking

- Check electrical connections.
- Check protection & alarm function.
- Check whether set point of hi-low pressure switch is normal.

### 5.3.5 Montly Checking

- Check refrigerant circulation pipe.
- Check whether there are bubbles in liquid indicator.
- Check whether there is abnormal sound in pump.
- Check whether there is scale formation in tank.

### 5.3.6 Trimonthly Checking

- Check whether condenser is under blockage.

### 5.3.7 Half-yearly Checking

- Check and clean the condenser and evaporator.
- Check and clean the filter and expansion valve.
- Check system performance.
- Clean condenser.

#### 5.3.8 Yearly Checking

- Check whether the contactor is normal.

#### 5.3.9 3 year Checking

- PC board renewal.
- No fuse breaker renewal.