

<b>版本</b> VerB		<b>标题</b> SG-4.360(H)/4.390(H) Main Circuit Diagram		<b>图号</b> SG-4.3系列-CE-400V-J-2		<b>比例</b> CE		<b>页码</b> 2 总共 15 页	
<b>设计</b>		<b>版本</b> J		<b>设计</b>		<b>标准</b>		<b>电压</b> 400V	
<b>校对</b>		<b>校对</b>		<b>校对</b>		<b>标准</b>		<b>频率</b> 50HZ	
<b>检查</b>		<b>检查</b>		<b>检查</b>		<b>标准</b>		<b>频率</b>	
<b>修改日期</b>		<b>修改日期</b>		<b>修改日期</b>		<b>标准</b>		<b>频率</b>	
<b>修改人</b>		<b>修改人</b>		<b>修改人</b>		<b>标准</b>		<b>频率</b>	
<b>日期</b> 2019104		<b>日期</b>		<b>日期</b>		<b>标准</b>		<b>频率</b>	

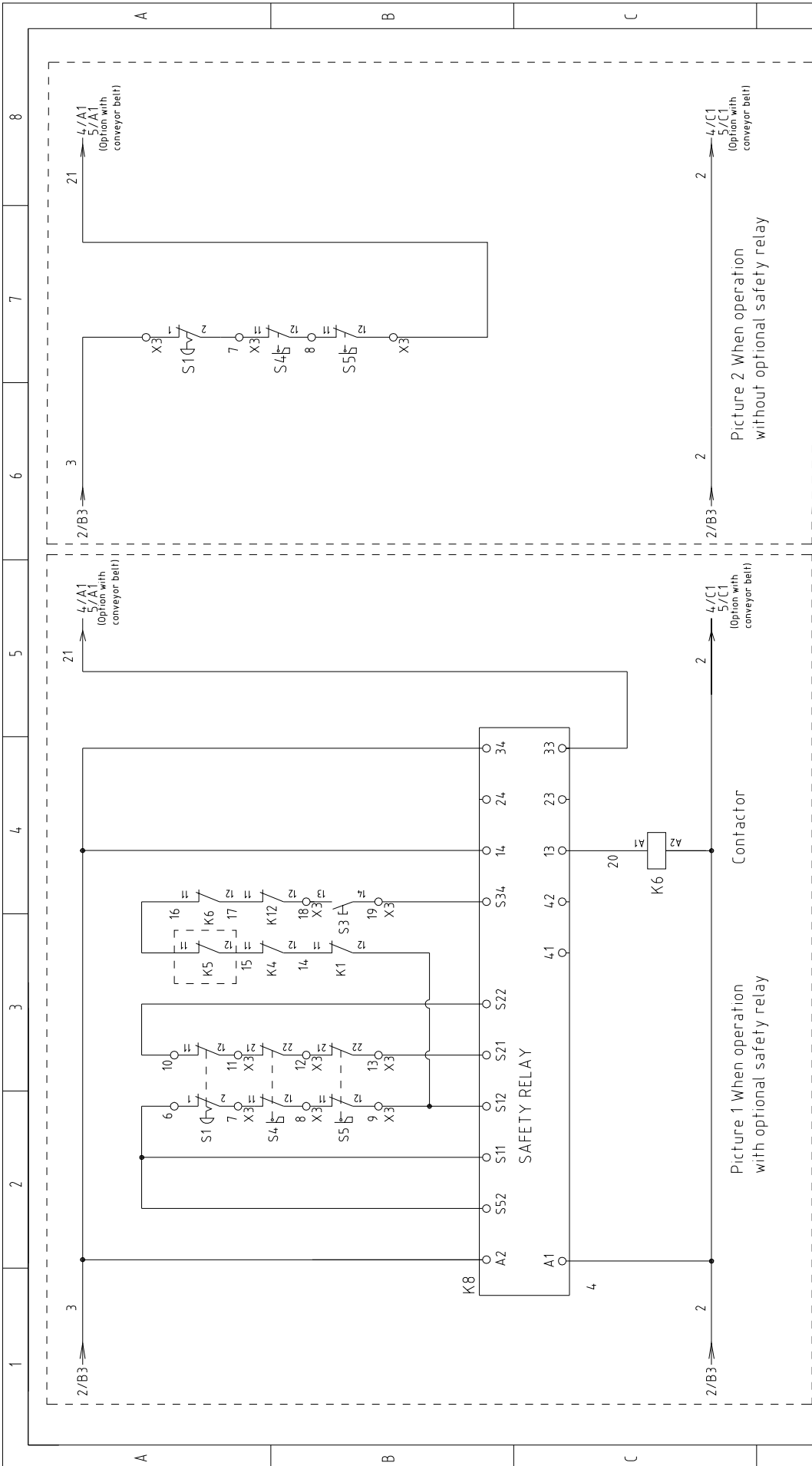



Mark	Before modification	Modified by	Modify date	Checked by	Proofread by	Designer	Drawer	Version	J	Title	SG-4.360(H)/4.390(H) Control Circuit Diagram 1	Scale	Standard	CE	Page	3
Version	Ver B															
Frequency	50HZ															
Voltage	400V															
Totally	15															

信易電熱機械股份有限公司  
Shini Plastics Technologies, Inc.

SHINI

SG-4.3系列-CE-400V-J-3

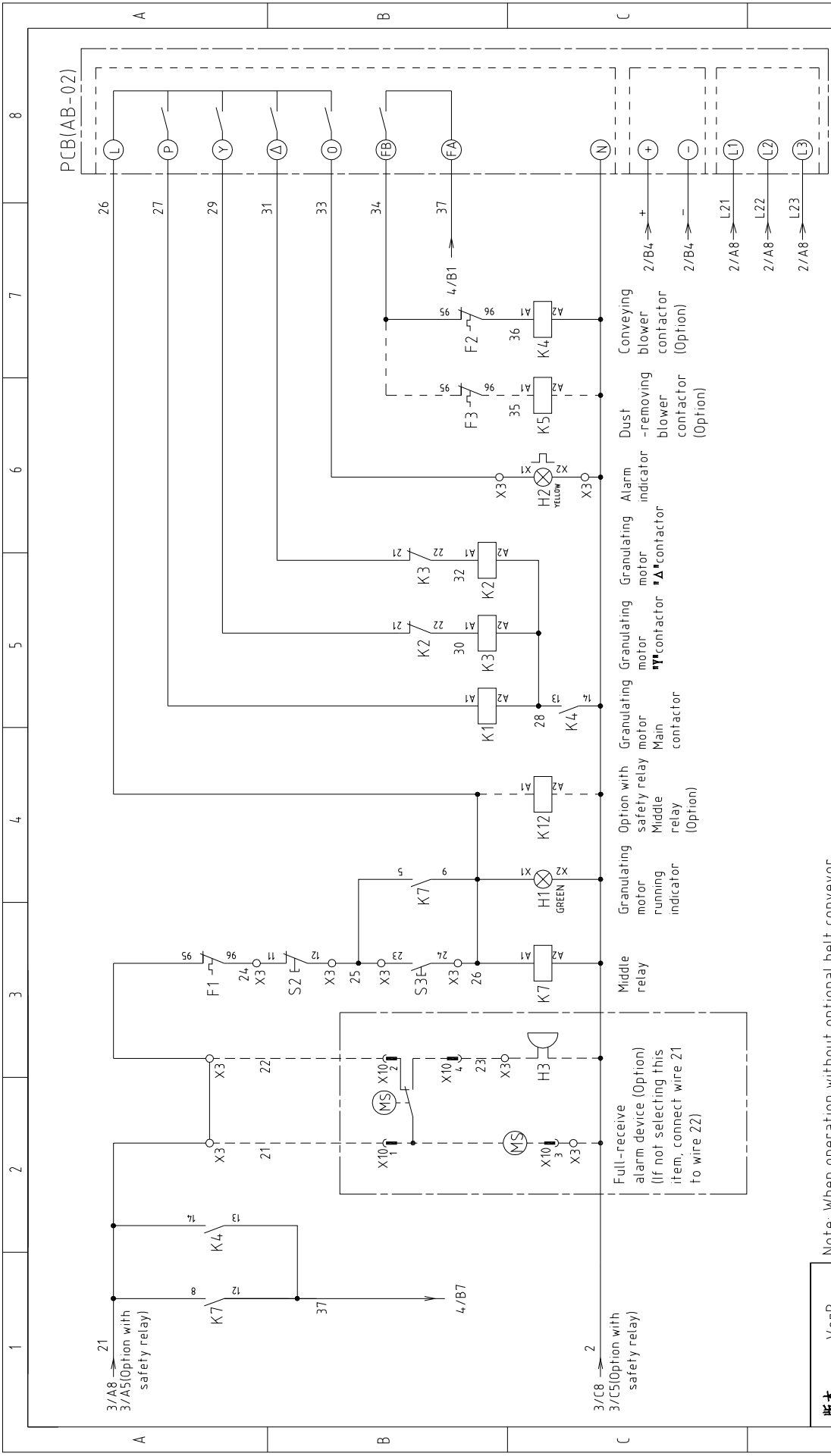

版本	VerB	Note: When operation without optional belt conveyor.		Title		Drawing NO		Scale	Page
				J	SG-4.360(H)/4.390(H)	SG-4.3系列-CE-400V-J-4	Standard	4	
Mark	Before modification	Modified by	Modify date	Checked by	Proofread by	Designer	Drawer	Version	Totally
								Approved by	15
								Date	Pages
								20190104	400V
									50HZ
									8





Control contact wiring diagram in collocation with belt conveyor

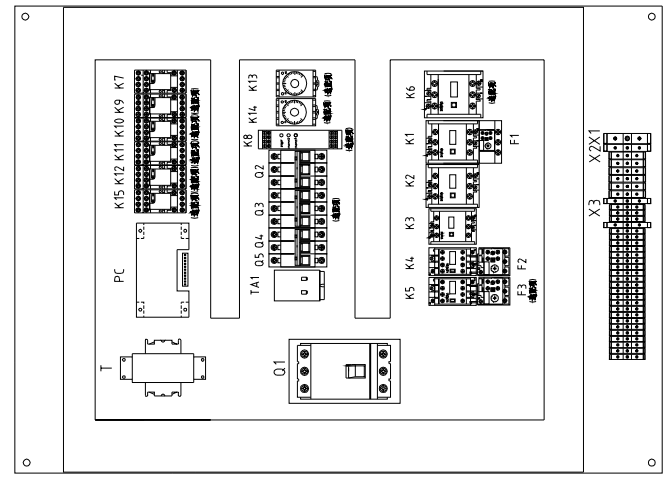
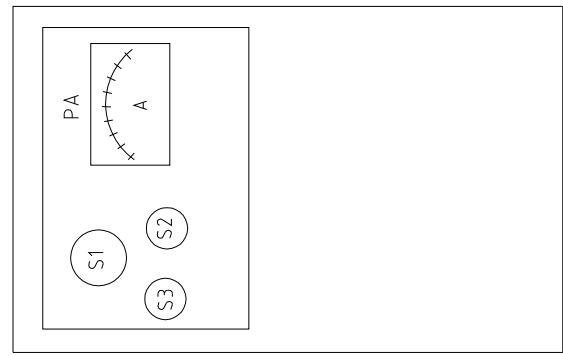
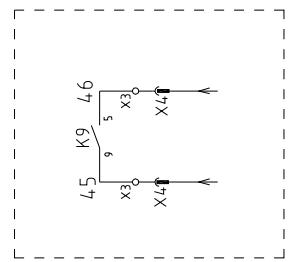

X4 Connection diagram of metal connectors  
Connect to belt conveyor (Option)

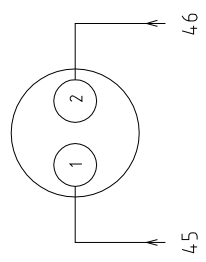

X10 Connection diagram of metal connectors  
Connect to full-receive alarm device (Option)

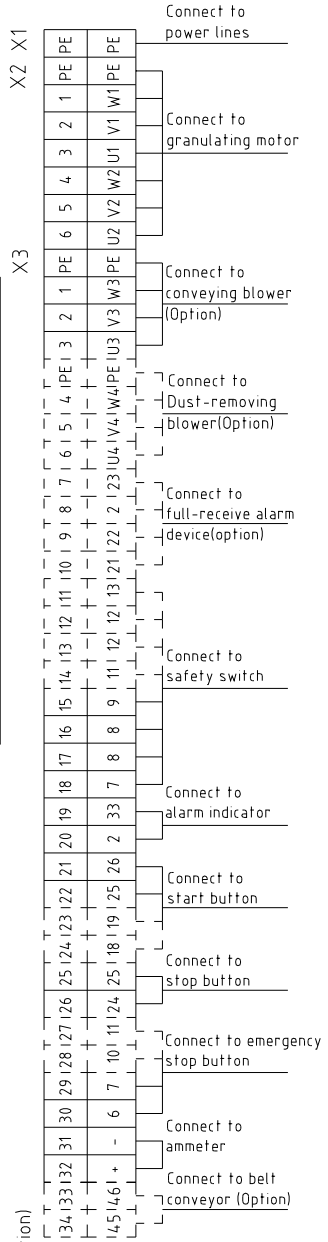
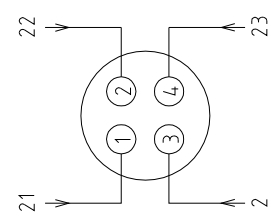

版本	Ver-B
Mark	Before modification
Modified by	
Modify date	
Checked by	
Proofread by	
Designer	
Drawer	
Version	J
Approved By	
Date	20190104

Note: when safety relay isn't the option, change terminal No.6 to No.3, No. 9 to No.21.

Title		SG-4360(H)/4390(H)		Drawing NO		SG-43系列-CE-400V-J-6		Scale		Standard		CE		Page		6			
Electrical Components Layout								Voltage		400V		Frequency		50HZ		Totally		15	
SHINI		信易电热机械股份有限公司		Shini Plastics Technologies, Inc.															

1	2	3	4	5	6	7	8	
NO.	Symbol	Name	Manufacturer	Type	Specification	Number	Material number	Remark
1	Q1	Breaker interlock	ABB	A1A125TMF125	125A	1	YE4.11614.00000	
2	Q2	Circuit-breaker	TECO	BM-63C/3P	10A	1	YE4.0301003000	
3	Q2	Circuit-breaker	TECO	BM-63C/3P	32A	1	YE4.0303203000	(6)
4	Q3	Circuit-breaker	TECO	BM-63C/3P	6A	1	YE4.0300603000	(2)
5	Q4	Circuit-breaker	TECO	BM-63C/2003S 2P	3A	1	YE4.0200203000	
6	Q5	Circuit-breaker	TECO	BM-63C/1006S 1P	6A	1	YE4.0100600100	
7	K1,K2	Contacto	SIEMENS	3RT5035-1AC20	24VAC 50/60Hz	2	YE00503502600	
8		Auxiliary contacto	SIEMENS	3RH5921-1CA01	1NC	1	YE00592110100	(4)
9		Auxiliary contacto	SIEMENS	3RH5921-1CA01	1NC	1	YE00592110100	
10		Auxiliary contacto	SIEMENS	3RH5921-1CA10	1NO	1	YE00592110000	(5)
11	K3	Contacto	SIEMENS	3RT6028-1AC20	24VAC 50/60Hz	1	YE00602802600	
12	K4	Contacto	SIEMENS	3RT6016-1AB01	24VAC 50/60Hz	1	YE00601602500	
13	K4	Contacto	SIEMENS	3RT6026-1AB01	24VAC 50/60Hz	1	YE00602602600	(6)
14		Auxiliary contacto	SIEMENS	3RH6911-1HA11	1NC+1NO	1	YE00691100100	
15	K5	Contacto	SIEMENS	3RT6016-1AB02	24VAC 50/60Hz	1	YE00601602600	(2)
16	K6	Contacto	SIEMENS	3RT5045-1AC20	24VAC 50/60Hz	1	YE00504502600	(4)
17		Auxiliary contacto	SIEMENS	3RH5921-1CA01	1NC	1	YE00592110100	(4)
18	K7	Middle relay	Honeywell	GR-2C-AC24V	24VAC	1	YE030224.00300	
19	K7	Middle relay	Honeywell	GR-4C-AC24V	24VAC	1	YE030424.00300	(5)
20	K8	Safety relay	PILZ	PN0Zx2 8P	24V AC/DC	1	YE04.0230000000	(4)
21	T	Transformer	BAIYUN	IN=400V/OUT=24V	180VA	1	YE704.024.00800	
22	K9 K10 K11 K15	Middle relay	Honeywell	GR-2C-AC24V	24VAC	4	YE030224.00300	(5)
23	K12	Middle relay	Honeywell	GR-2C-AC24V	24VAC	1	YE030224.00300	(4)
24	K13	Timer	YUYUN	TRF-N/3M	24VAC	1	YE860324.00000	(5)
25	K14	Timer	YUYUN	TH3A-NAB 60S	24VAC	1	YE866024.00300	(5)
版本	Ver B	Notes: (1)Means it's not the material inside the control box (2) Means optional accessories of dedusting blower.(3) Means optional accessories of full-receive alarm device. (4)Stand for optional safety relay.(5)Stand for conveying belt optional accessories.(6)Stands for options of the feeding blower to increase the power.			Drawing NO			
				Title	SG-4360	Scale		Page
				Version	J	Standard		7
				Approved by	Electrical Components list 1		Totally 15 Pages	
				Proofread by	SG-43系列-CE-4.00V-J-7		Voltage	
				Checked by	SHINI		Frequency	
				Modify date	信易電熱機械股份有限公司 Shini Plastics Technologies, Inc.		400V	
Mark	Before modification	Modified by	20191014	Date			50HZ	
1	2	3	4	5	6	7	8	







1	2		3	4	5	6	7	8	
NO.	Symbol	Name	Manufacturer	Type	Specification	Number	Material number	Remark	
1	Q1	Breaker interlock	ABB	AZB250TMF160	160A	1	YE4.1161500000		
2	Q2	Circuit-breaker	TECO	BM-63C/3P	10A	1	YE4.0301003000		
3	Q2	Circuit-breaker	TECO	BM-63C/3P	32A	1	YE4.0303203000	(6)	
4	Q3	Circuit-breaker	TECO	BM-63C/3P	6A	1	YE4.0300603000	(2)	
5	Q4	Circuit-breaker	TECO	BM-63C/2003S 2P	3A	1	YE4.0200203000		
6	Q5	Circuit-breaker	TECO	BM-63C/1010S 1P	10A	1	YE4.0101000100		
7	K1,K2	Contactor	SIEMENS	3RT5036-1AC20	24VAC 50/60Hz	2	YE00503602600		
8	K3	Contactor	SIEMENS	3RT5035-1AC20	24VAC 50/60Hz	1	YE00503502600		
9		Auxiliary contactor	SIEMENS	3RH5921-1CA01	1NC	2	YE00592110100		
10		Auxiliary contactor	SIEMENS	3RH5921-1CA10	1NO	1	YE00592110000	(5)	
11		Auxiliary contactor	SIEMENS	3RH5921-1CA01	1NC	1	YE00592110100	(4)	
12	K4	Contactor	SIEMENS	3RT6016-1AB01	24VAC 50/60Hz	1	YE00601602500		
13	K4	Contactor	SIEMENS	3RT6026-1AB01	24VAC 50/60Hz	1	YE00602602600	(6)	
14		Auxiliary contactor	SIEMENS	3RH6911-1HA11	1NC+1NO	1	YE00691100100		
15	K5	Contactor	SIEMENS	3RT6016-1AB02	24VAC 50/60Hz	1	YE00601602600	(2)	
16	K6	Contactor	SIEMENS	3RT5046-1AC20	24VAC 50/60Hz	1	YE00504602600	(4)	
17		Auxiliary contactor	SIEMENS	3RH5921-1CA01	1NC	1	YE00592110100	(4)	
18	K7	Middle relay	Honeywell	GR-2C-AC24V	24VAC	1	YE030224.00300		
19	K7	Middle relay	Honeywell	GR-4C-AC24V	24VAC	1	YE030424.00300	(5)	
20	K8	Safety relay	PILZ	PN0Zx2 8P	24V AC/DC	1	YE04.0230000000	(4)	
21	K9 K10 K11 K15	Middle relay	Honeywell	GR-2C-AC24V	24VAC	4	YE030224.00300	(5)	
22	K12	Middle relay	Honeywell	GR-2C-AC24V	24VAC	1	YE030224.00300	(4)	
23	K13	Timer	YUYUN	TRF-N/3M	24VAC	1	YE860324.00000	(5)	
24	K14	Timer	YUYUN	TH3A-NAB 60S	24VAC	1	YE866024.00300	(5)	
25	F1	Overload relay	SIEMENS	3RU5136-4GB0	36-45A	1	YE01612660000		
版本	Ver B	Notes: (1)Means it's not the material inside the control box (2) Means optional accessories of dedusting blower.(3) Means optional accessories of full-receive alarm device. (4)Stand for optional safety relay.(5)Stand for conveying belt optional accessories.(6)Stands for options of the feeding blower to increase the power.							
D				Version	J	Title		Scale	Page
				Designer		SG-4 360H/4 390		Standard	10
				Proofread by		Electrical Components list 1		CE	Totally 15 Pages
				Checked by	20191014			Voltage	400V
Mark				After modification	Modify date			Frequency	50HZ
1	2	3	4	5	6	7	8		



信易電熱機械股份有限公司  
Shini Plastics Technologies, Inc.

1	2	3	4	5	6	7	8	
NO.	Symbol	Name	Manufacturer	Type	Specification	Number	Material number	Remark
26	F2	Overload relay	SIEMENS	3RU6116-1FB0	3.5-5A	1	YE01160350000	
27	F2	Overload relay	SIEMENS	3RU6126-4BB0	14-20A	1	YE01260140000	(6)
28	F3	Overload relay	SIEMENS	3RU6116-1DB0	2.2-3.2A	1	YE01160220000	(2)
29	S1	Emergency stop button	SCHNEIDER	XB2BS542C	400VAC	1	YE11254200000	(1)
30		Contact block	SCHNEIDER	ZB2BE102C	1NC	1	YE00210203100	(1)(4)
31	S2	Stop button	SCHNEIDER	XB2BA22C	400VAC	1	YE11222000000	(1)
32	S3,H1	Start button	SCHNEIDER	XB2BW33B1C	24VAC	1	YE11233100000	(1)
33		Contact block	SCHNEIDER	ZB2BE101C	1NO	1	YE00210103100	(1)(4)
34	S4,S5	Safety switch	SCHMERSRC	AZ16-02ZYRK-14.76	230VAC	2	YE16147600000	(1)(4)
35	S4,S5	Safety switch	SCHMERSRC	AZ15-02ZYRK-14.76	230VAC	2	YE16147600100	(1)
36	H2	Alarm lamp	SHINI	LED-3051	24VAC 50/60Hz	1	YE83305100900	(1)
37	H3	Buzzer	TEND	EA-2	24VAC	1	YE84240200000	(1)(3)
38	MS	Metal connector	SHINI	SR-80	24VAC	1	YE15802400100	(1)(3)
39	T	Transformer	BAIYUN	IN=400V/OUT=24V	230VA	1	YE70402400900	
40	TA1	Current transformer	RATIO	RQT-35	100/5A	1	YE04100500000	
41	PA	Ammeter	SFIM	DH-670	100/5A	1	YE25671000000	(1)
42	PCB	PCB	YUYUN	AB-02	24VAC	1	YE80022400100	
43	TA2	Current transformer	YUYUN	-----	5-100A	1	-----	
44	X1	Terminal	Honeywell	16PE	---	1	YE60001603500	
45	X2	Terminal	Honeywell	10mm <sup>2</sup>	---	6	YE60001003200	
46			Honeywell	10mm <sup>2</sup> PE	---	1	YE60001003500	
47	X3	Terminal	Honeywell	2.5mm <sup>2</sup>	---	17	YE60002503200	
48			Honeywell	2.5mm <sup>2</sup> PE	---	1	YE60002503400	
49			Honeywell	2.5mm <sup>2</sup>	---	3	YE60002503200	(2)
50			Honeywell	2.5mm <sup>2</sup> PE	---	1	YE60002503400	(2)
<b>版本</b> Ver B Notes: (1)Means it's not the material inside the control box (2) Means optional accessories of dedusting blower.(3) Means optional accessories of full-receive alarm device. (4)Stand for optional safety relay.(5)Stand for conveying belt optional accessories.(6)Stand for options of the feeding blower to increase the power.								
				Version	J	Drawing NO		Scale
				Approved by	SG-4360H/4390			Standard
				Date	Electrical Components List 2			CE
				Checked by	SG-43系列-CE-400V-J-11			Page 11
				Modify date	SHINI			Totally 15 Pages
				Modified by	信易電熱機械股份有限公司			Voltage 400V
				After modification	Shini Plastics Technologies, Inc.			Frequency 50HZ
1	2	3	4	5	6	7	8	



信易電熱機械股份有限公司  
Shini Plastics Technologies, Inc.



1	2		3	4	5	6	7	8
NO.	Symbol	Name	Manufacturer	Type	Specification	Number	Material number	Remark
1	Q1	Breaker interlock	ABB	AZB250TMF200	200A	1	YE4.1252200000	
2	Q2	Circuit-breaker	TECO	BM-63C/3P	10A	1	YE4.0301003000	
3	Q2	Circuit-breaker	TECO	BM-63C/3P	32A	1	YE4.0303203000	(6)
4	Q3	Circuit-breaker	TECO	BM-63C/3P	6A	1	YE4.0300603000	(2)
5	Q4	Circuit-breaker	TECO	BM-63C/2003S 2P	3A	1	YE4.0200203000	
6	Q5	Circuit-breaker	TECO	BM-63C/1010S 1P	10A	1	YE4.0101000100	
7	K1,K2	Contactor	SIEMENS	3RT5044-1AC20	24VAC 50/60Hz	2	YE005044.02600	
8	K3	Contactor	SIEMENS	3RT5036-1AC20	24VAC 50/60Hz	1	YE00503602600	
9		Auxiliary contactor	SIEMENS	3RH5921-1CA01	1NC	2	YE00592110100	
10		Auxiliary contactor	SIEMENS	3RH5921-1CA10	1NO	1	YE00592110000	(5)
11		Auxiliary contactor	SIEMENS	3RH5921-1CA01	1NC	1	YE00592110100	(4)
12	K4	Contactor	SIEMENS	3RT6016-1AB01	24VAC 50/60Hz	1	YE00601602500	
13	K4	Contactor	SIEMENS	3RT6026-1AB01	24VAC 50/60Hz	1	YE00602602600	(6)
14		Auxiliary contactor	SIEMENS	3RH6911-1HA11	1NC+1NO	1	YE00691100100	
15	K5	Contactor	SIEMENS	3RT6016-1AB02	24VAC 50/60Hz	1	YE00601602600	(2)
16	K6	Contactor	SIEMENS	3RT5054-1AB36	24V 50/60Hz	1	YE005054.00900	
17	K7	Middle relay	Honeywell	GR-2C-AC24V	24VAC	1	YE030224.00300	(4)
18	K7	Middle relay	Honeywell	GR-4C-AC24V	24VAC	1	YE030424.00300	(5)
19	K8	Safety relay	PILZ	PN0Z x 2 8P	24V AC/DC	1	YE04.0230000000	(4)
20	K9 K10 K11 K15	Middle relay	Honeywell	GR-2C-AC24V	24VAC	4	YE030224.00300	(5)
21	K12	Middle relay	Honeywell	GR-2C-AC24V	24VAC	1	YE030224.00300	(4)
22	K13	Timer	YUYUN	TRF-N/3M	24VAC	1	YE860324.00000	(5)
23	K14	Timer	YUYUN	TH3A-NAB 60S	24VAC	1	YE866024.00300	(5)
24	F1	Overload relay	SIEMENS	3RU5146-4JB0	45-63A	1	YE015146.40000	
25	F2	Overload relay	SIEMENS	3RU6116-1FB0	3.5-5A	1	YE01160350000	
版本	Ver B	Notes: (1)Means it's not the material inside the control box (2) Means optional accessories of dedusting blower.(3) Means optional accessories of full-receive alarm device. (4)Stand for optional safety relay (5)Stand for conveying belt optional accessories.(6)Stand for options of the feeding blower to increase the power.			Drawing NO SG-43系列-CE-400V-J-13		Scale Standard	Page 13 Totally 15 Pages
Mark	Before modification	Modified by	Modify date	20191014	Electrical Components list 1		CE	Voltage 400V
	After modification	Checked by	Date	20191014	SHINI 信易電熱機械股份有限公司 Shini Plastics Technologies, Inc.		Frequency 50HZ	

1	2	3	4	5	6	7	8	
NO.	Symbol	Name	Manufacturer	Type	Specification	Number	Material number	Remark
26	F2	Overload relay	SIEMENS	3RU6126-4BB0	14-20A	1	YE01260140000	(6)
27	F3	Overload relay	SIEMENS	3RU6116-1DB0	2.2-3.2A	1	YE01160220000	(2)
28	S1	Emergency stop button	SCHNEIDER	XB2BS542C	4.00VAC	1	YE11254200000	(1)
29		Contact block	SCHNEIDER	ZB2BE102C	1NC	1	YE00210203100	(1)(4)
30	S2	Stop button	SCHNEIDER	XB2BA22C	4.00VAC	1	YE11222000000	(1)
31	S3,H1	Start button	SCHNEIDER	XB2BW33B1C	24VAC	1	YE11233100000	(1)
32		Contact block	SCHNEIDER	ZB2BE101C	1NO	1	YE00210103100	(1)(4)
33	S4,S5	Safety switch	SCHMERSRC	AZ15-02ZVRK-14.76	230VAC	2	YE1614.7600100	(1)
34	S4,S5	Safety switch	SCHMERSRC	AZ16-02ZVRK-14.76	230VAC	2	YE1614.7600000	(1)(4)
35	H2	Alarm lamp	SHINI	LED-3051	24VAC 50/60Hz	1	YE83305100900	(1)
36	H3	Buzzer	TEND	EA-2	24VAC	1	YE84240200000	(1)(3)
37	MS	Material level motor	SHINI	SR-80	24VAC	1	YE15802400100	(1)(3)
38	T	Transformer	BAYUN	IN=400V/OUT=24V	350VA	1	YE70402400900	
39	TA1	Current transformer	RATIO	RCT-35	150/5A	1	YE04150500000	
40	PA	Ammeter	SFIM	DH-670	150/5A	1	YE25671500000	
41	PCB	PCB	YUYUN	AB-02	24VAC	1	YE80022400100	
42	TA2	Current transformer	YUYUN	-----	5-100A	1	-----	
43	X1	Terminal	Honeywell	16mm <sup>2</sup> PE	---	1	YE60001603500	
44	X2	Terminal	Honeywell	16mm <sup>2</sup>	---	6	YE60001603200	
45			Honeywell	16mm <sup>2</sup> PE	---	1	YE60001603500	
46	X3	Terminal	Honeywell	2.5mm <sup>2</sup>	---	17	YE60002503200	
47			Honeywell	2.5mm <sup>2</sup> PE	---	1	YE60002503400	
48			Honeywell	2.5mm <sup>2</sup>	---	3	YE60002503200	(2)
49			Honeywell	2.5mm <sup>2</sup> PE	---	1	YE60002503400	(2)
50			Honeywell	2.5mm <sup>2</sup>	---	4	YE60002503200	(3)
<b>版本</b> Ver B Notes: (1)Means it's not the material inside the control box (2) Means optional accessories of dedusting blower.(3) Means optional accessories of full-receive alarm device (4)Stand for optional safety relay(5)Stand for conveying belt optional accessories.(6)Stand for options of the feeding blower to increase the power.								
			Drawer	Version	Title		Scale	
			Designer	Approved by	SG-4 390H		Standard	Page 14
			Proofread by		Electrical Components List 2		CE	Totally 15 Pages
			Checked by	Date	SG-4.3系列-CE-400V-J-14		Voltage	400V
Mark			Modified by	Modify date	信易電熱機械股份有限公司 Shini Plastics Technologies, Inc.		Frequency	50HZ
1			4		5		8	

