

机型版本 Ver.C

					Drawer	Version	C	Title	SHD-12EB	Drawing NO	Scale	Page	1
					Designer	Approved by		Electrical Principle		SHD-12EB-GB-400V-C-1	Standard	GB	Totally 3 Pages
					Proofread by	Date	20201208	 信易電熱機械股份有限公司 Shini Plastics Technologies, Inc.		Voltage	3Φ/N/400V		
Mark	Before modification	After modification	Modified by	Modify date	Checked by		Frequency			50Hz			

1 2 3 4 5 6 7 8

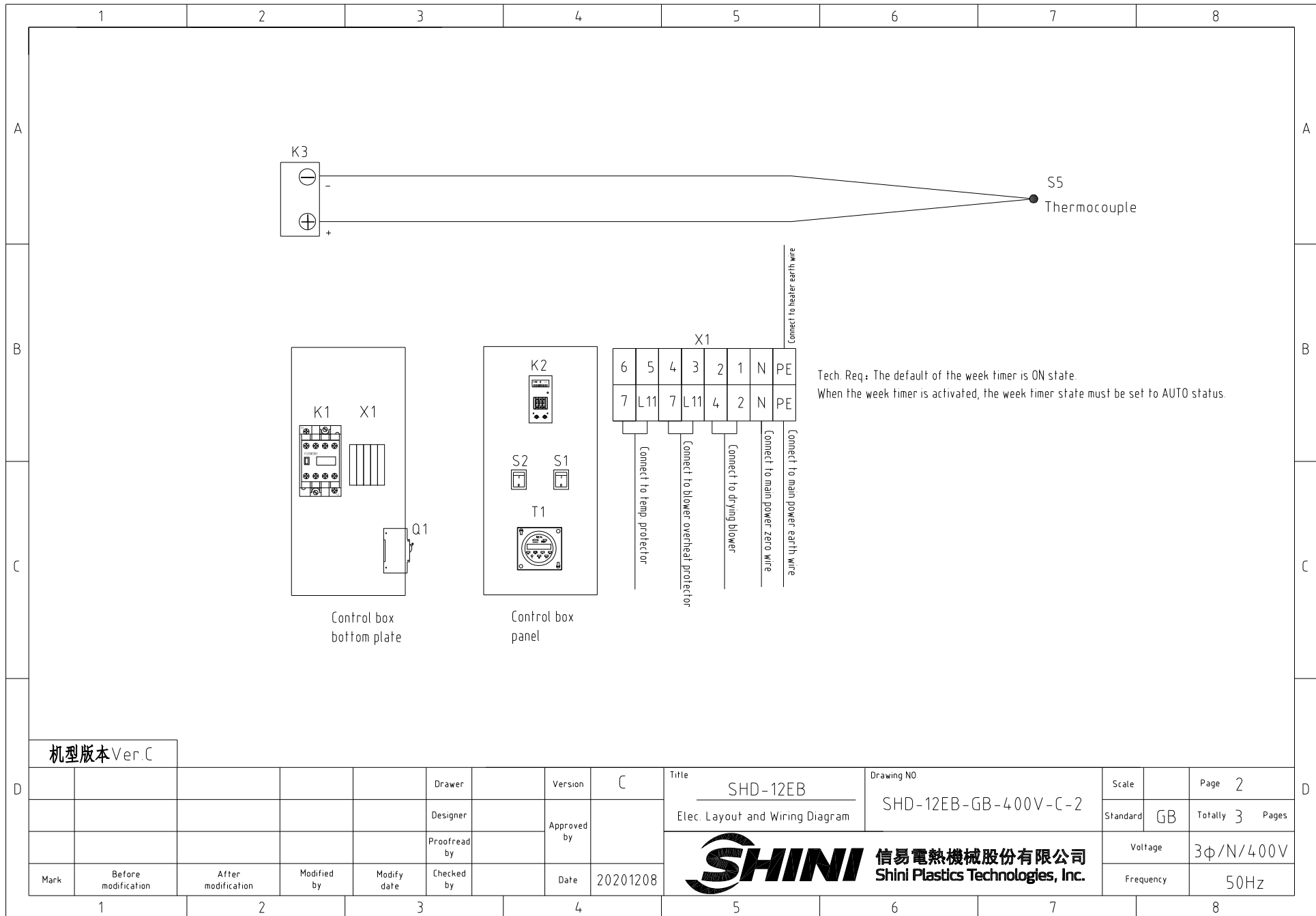

Tech. Req.: The default of the week timer is ON state.
 When the week timer is activated, the week timer state must be set to AUTO status.

机型版本 Ver.C

				Drawer	Version	C	Title	SHD-12EB	Drawing NO	SHD-12EB-GB-400V-C-2	Scale	Page	2
				Designer	Approved by		Elec. Layout and Wiring Diagram				Standard	GB	Totally 3 Pages
				Proofread by	Date	20201208	 信易電熱機械股份有限公司 Shini Plastics Technologies, Inc.				Voltage	3φ/N/400V	
Mark	Before modification	After modification	Modified by	Modify date	Checked by						Frequency	50Hz	

1		2		3		4		5		6		7		8							
NO.	Symbol	Name		Manufacturer		Type		Specification		Number	Material number		Remark								
1	Q1	Circuit breaker		TECO		BM-63C/3006S		6A/3P		1	YE40300603000										
2		Excitation release		YIJIN		MX		110V-400V 50/60Hz		1	YE40023560000										
3	K1	Contactor		SIEMENS		3RT6016-1AN21		220V 50/60Hz		1	YE00601621000										
4	K2	Temp. controller		RONGDA		0-199℃		110V/220V 50/60Hz		1	YE85019900300										
5	T1	周定时器/week Timer		SHINI		TM69-2		220V 50/60Hz		1	YE86061900100		Cancel								
6	T1	Week timer		TBCTL		CN101		200V/250V 50/60Hz		1	YE86101000100		Newly increased								
7		Week timer housing		TBCTL		----		----		1	YR40101000100		Newly increased								
8	S1 S2	Alternative switch		ZHONGXUN		T120/55		4P (WH)		2	YE10210400000										
9	S4	Temperature protector		TONGBAO		KSD301-105		15A		1	----		(1)								
10	S5	Thermocouple		SHINI		K TYPE		----		1	----		(1)								
11	M1	Blower		LONGFENG		0.075kW		400V 50/60Hz		1	----		(1)								
12	EH1	Heater		SHINI		2.2KW		400V 50/60Hz		1	----		(1)								
13	X1	Terminal board		HONEYWELL		SK2.5		2.5mm ²		7	YE60002503200										
14		Wiring terminal board		HONEYWELL		GK2.5		2.5mm ² PE		1	YE60002503400										
15		Terminal fittings E/GK series		HONEYWELL		E		GK series		2	YE60000003900										
机型版本 Ver.C		Notes: (1)Materials not in the control box.																			
D	Mark	Before modification	After modification	Modified by	Modify date	Checked by	Date	20201208	Version	C	Title	SHD-12EB Elec. Parts List	Drawing NO	SHD-12EB-GB-400V-C-3	Scale	GB	Page	3	Totally	3	Pages
												Voltage		3φ/N/400V							
												Frequency		50Hz							

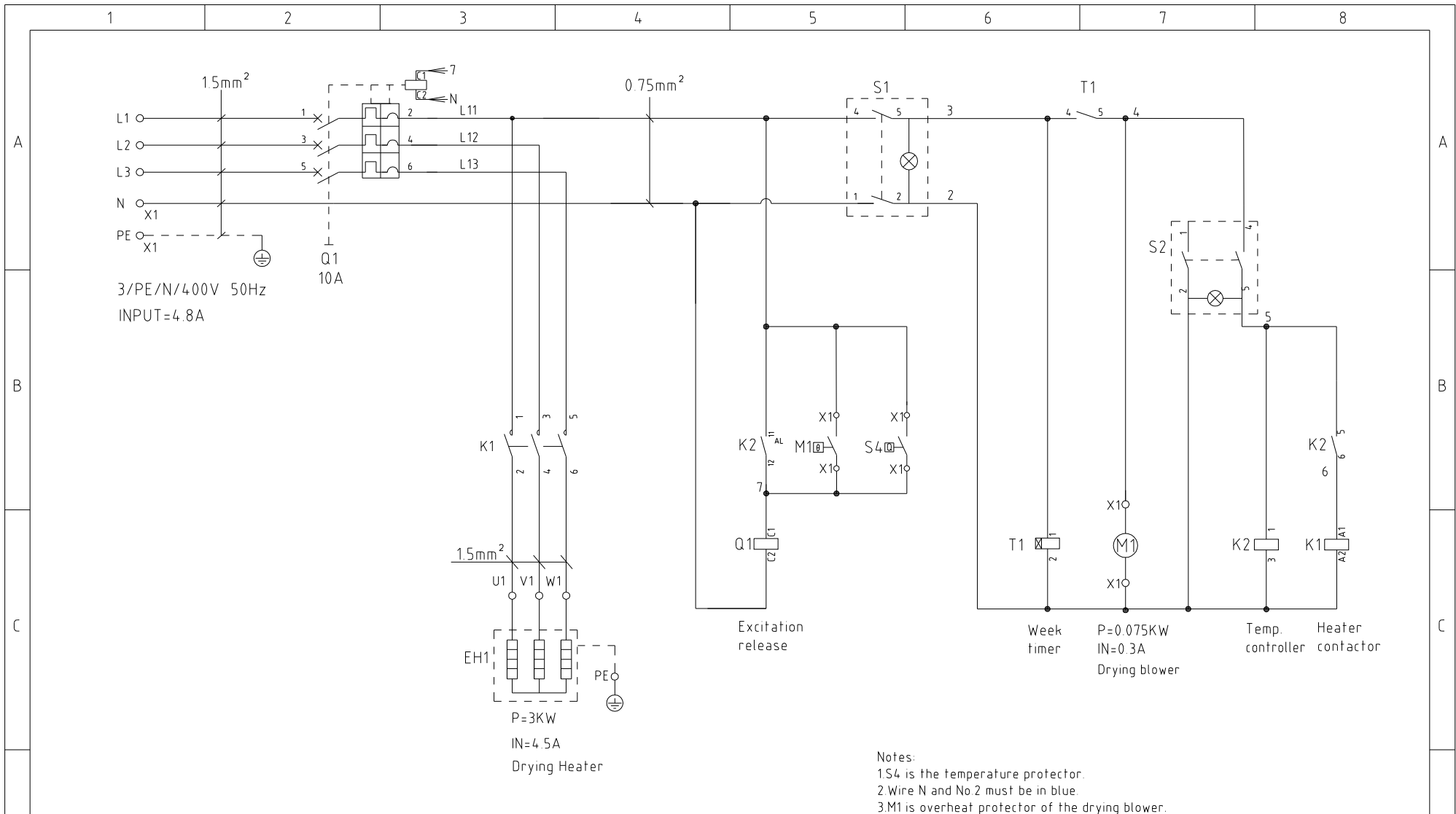

Notes:
 1.S4 is the temperature protector.
 2.Wire N and No 2 must be in blue.
 3.M1 is overheat protector of the drying blower.
 4.Pipe heater SHD-25EB-150EB adopts lead in the connection for overheat protection.

机型版本 Ver.E						制图		版号 E		标题 SHD-25EB		图号 SHD-25EB-GB-400V-E-1		比例		第 1 张	
						设计		核准		Electrical Diagram		标准 GB		共 3 张			
						校对				信易電熱機械股份有限公司 Shini Plastics Technologies, Inc.		机器电压		3φ/N/400V			
标记						更改前		更改后				更改人		机器频率		50Hz	
1		2		3		4		5		6		7		8			

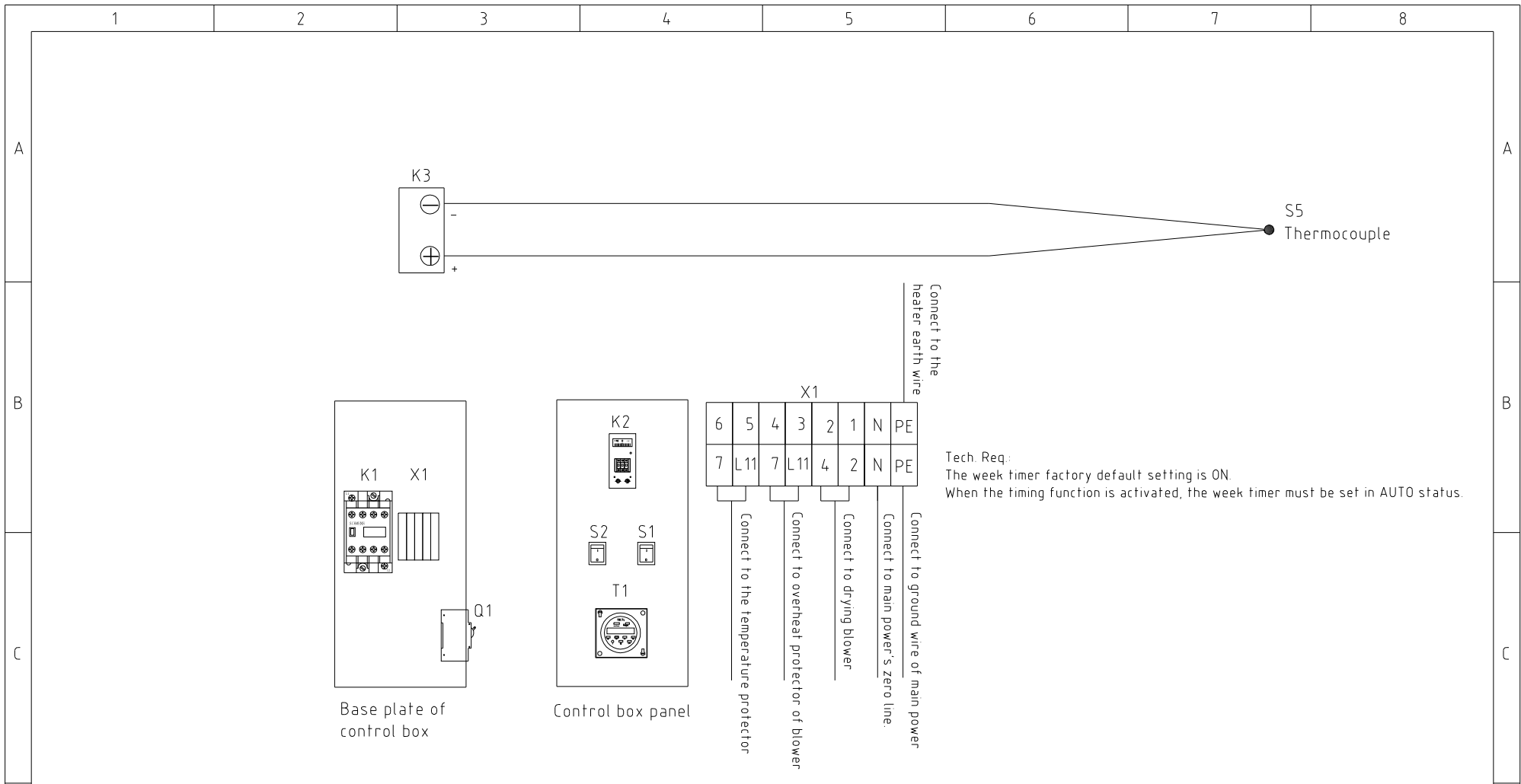

机型版本 Ver.E

					制图	版号		E	标题	SHD-25EB	图号	SHD-25EB-GB-400V-E-2	比例	第 2 张
					设计	核准			Electrical layout and wiring drawing	 信易電熱機械股份有限公司 Shini Plastics Technologies, Inc.	标准	GB	共 3 张	
					校对						机器电压	3φ/N/400V		
标记	更改前	更改后	更改人	日期	审核	日期	20210719			机器频率	50Hz			

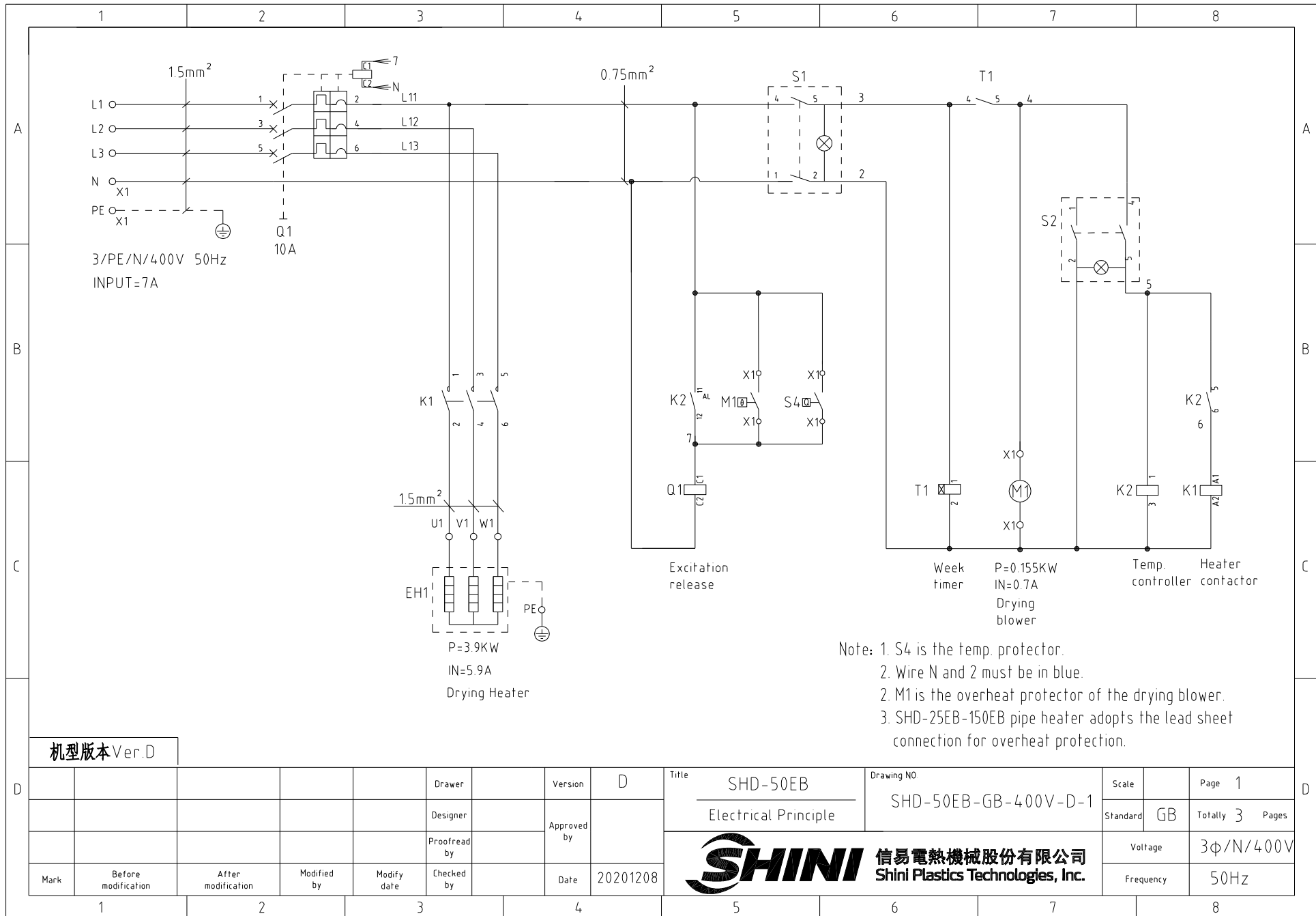

Note: 1. S4 is the temp. protector.
 2. Wire N and 2 must be in blue.
 2. M1 is the overheater protector of the drying blower.
 3. SHD-25EB-150EB pipe heater adopts the lead sheet connection for overheater protection.

机型版本 Ver.D

				Drawer	Version	D	Title	Drawing NO	Scale	Page
				Designer	Approved by		SHD-50EB	SHD-50EB-GB-400V-D-1	GB	1
				Proofread by	Date	20201208	Electrical Principle		Totally	3
Mark	Before modification	After modification	Modified by	Checked by	Date	20201208	 信易電熱機械股份有限公司 Shini Plastics Technologies, Inc.		Voltage	3φ/N/400V
1	2	3	4	5	6	7			8	Frequency

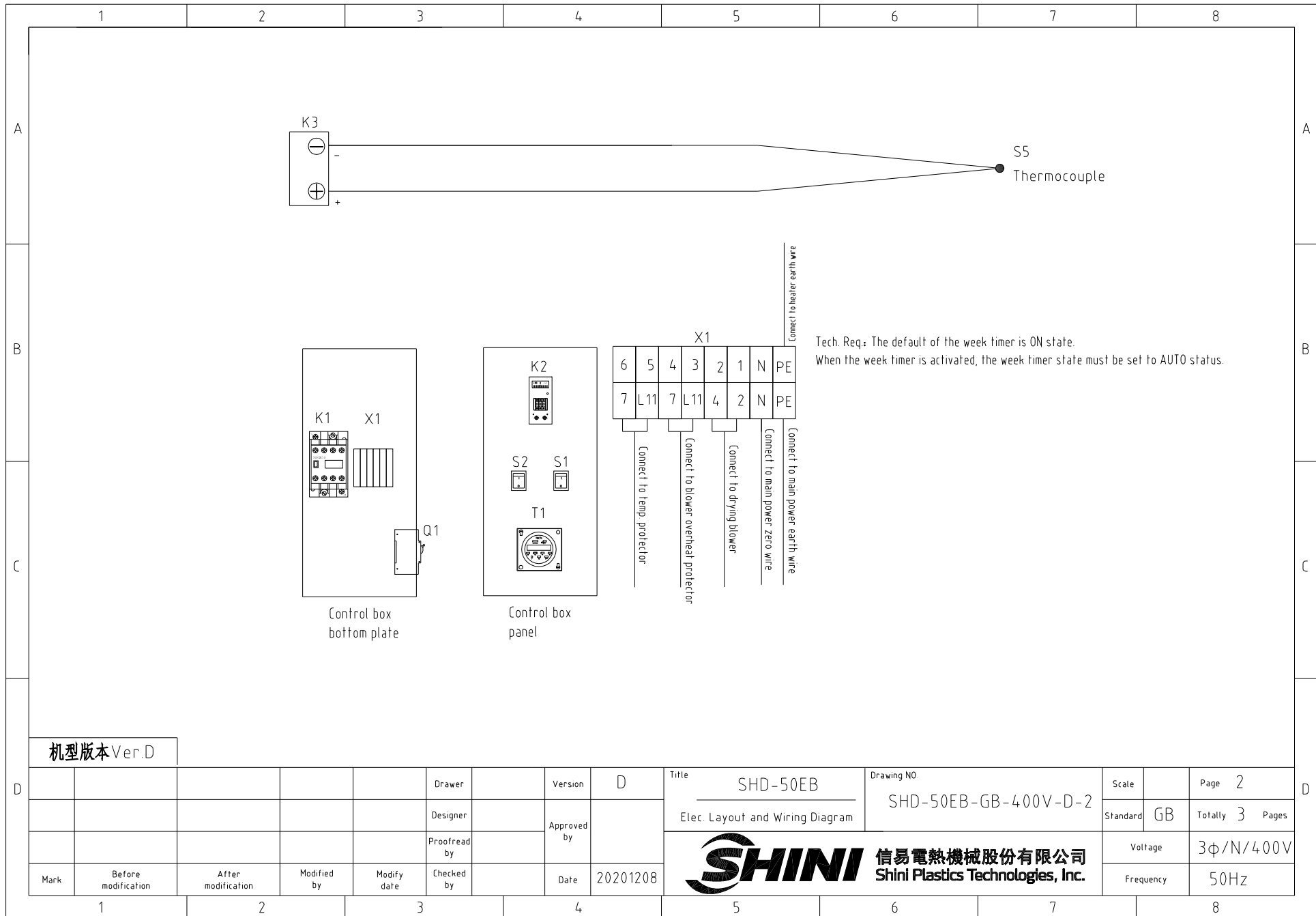

Tech. Req.: The default of the week timer is ON state.
 When the week timer is activated, the week timer state must be set to AUTO status.

机型版本 Ver.D

				Drawer	Version	D	Title	SHD-50EB	Drawing NO	SHD-50EB-GB-400V-D-2	Scale	Page	2	
				Designer	Approved by		Elec. Layout and Wiring Diagram				Standard	GB	Totally	3 Pages
				Proofread by							Voltage	3φ/N/400V		
Mark	Before modification	After modification	Modified by	Modify date	Checked by	Date	20201208				Frequency	50Hz		



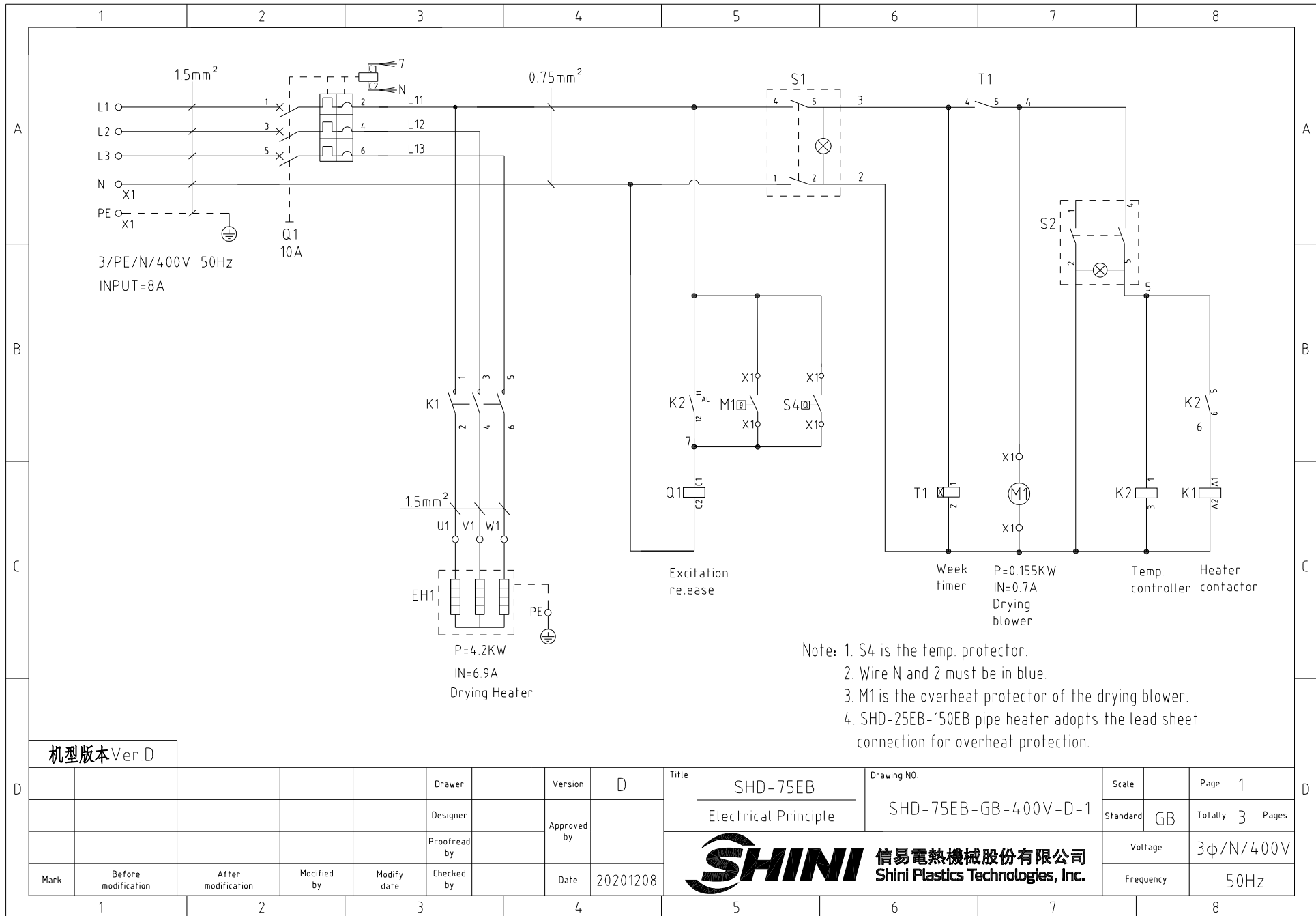

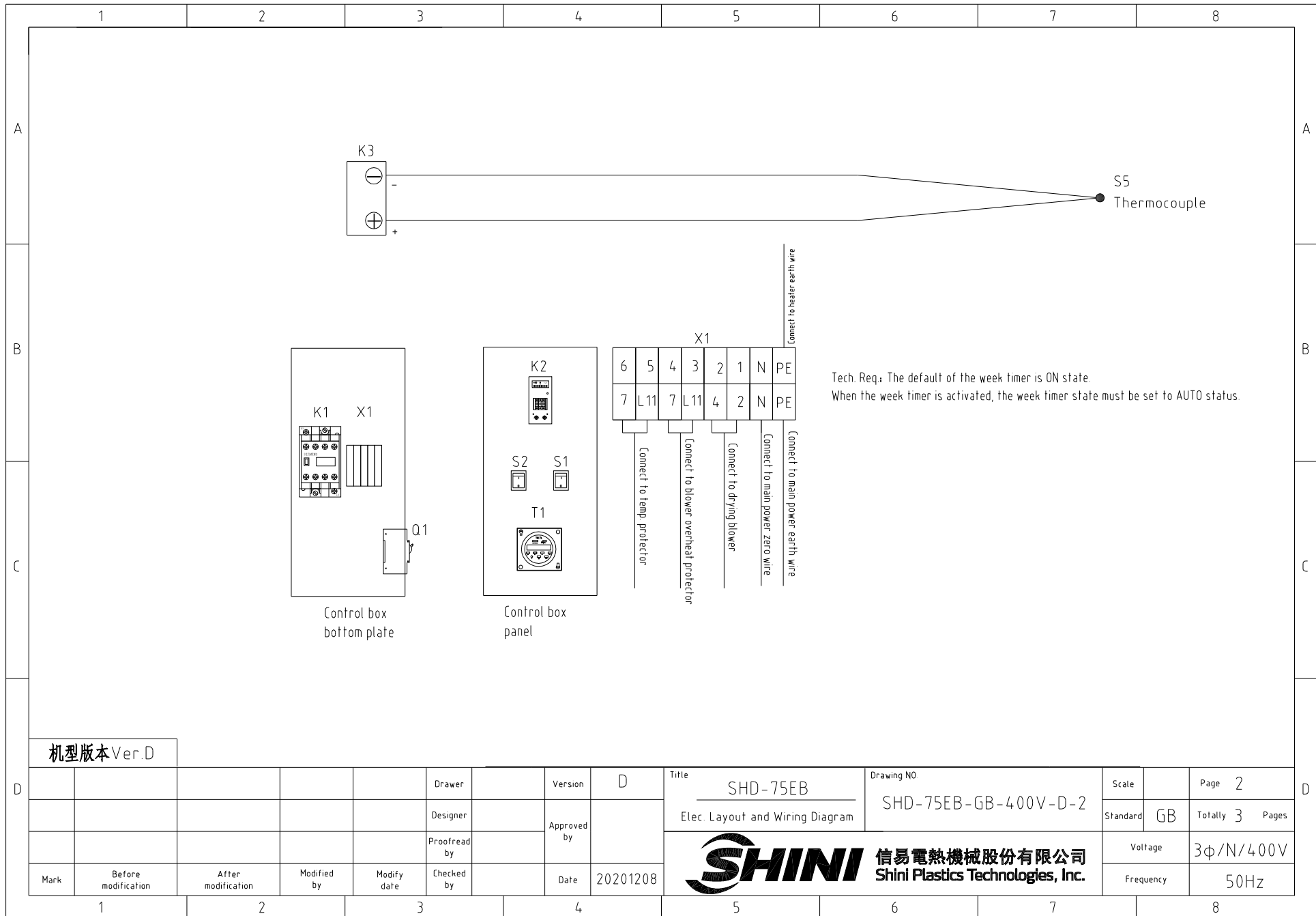

机型版本 Ver.D

					Drawer	Version	D	Title	SHD-75EB	Drawing NO	SHD-75EB-GB-400V-D-2	Scale	Page	2	
					Designer	Approved by		Elec. Layout and Wiring Diagram				Standard	GB	Totally	3 Pages
					Proofread by			 信易電熱機械股份有限公司 Shini Plastics Technologies, Inc.				Voltage	3φ/N/400V		
Mark	Before modification	After modification	Modified by	Modify date	Checked by	Date	20201208					Frequency	50Hz		

1		2		3		4		5		6		7		8	
N0.	Symbol	Name		Manufacturer		Type		Specification		Number	Material number		Remark		
1	Q1	Circuit breaker		TECO		BM-63C/3010S		10A/3P		1	YE40301003000				
2		Excitation release		YIJIN		MX		230V 50/60Hz		1	YE40023560000				
3	K1	接触器/Contactor		SIEMENS		3RT6016-1AN22		220V 50/60Hz		1	YE00601622000		Cancel		
4	K1	Contactor		SIEMENS		3RT6016-1AN21		220V 50/60Hz		1	YE00601621000		Newly increased		
5	K2	Temp. controller		RONGDA		0-199℃		110V/220V 50/60Hz		1	YE85019900300				
6	T1	周定时器/WEEKTimer		SHINI		24H A-TB-72-D		220V 50/60Hz		1	YE86061900100		Newly increased		
7	T1	Week timer		TBCTL		CN101		200V/250V 50/60Hz		1	YE86101000100		New		
8		Week timer housing		TBCTL		----		----		1	YR40101000100		New		
9	S1 S2	Control switch		ZHONGXUN		T120/55		4P (WH)		2	YE102104.00000				
10	S4	Temperature protector		TONGBAO		KSD301-105		15A		1	----		New (1)		
11	S5	Thermocouple		SHINI		K TYPE		----		1	----		(1)		
12	M1	Blower		LONGFENG		0.155kW		230V 50/60Hz		1	----		(1)		
13	EH1	Heater		SHINI		4.2KW		400V 50/60Hz		1	----		(1)		
14	X1	Terminal board		HONEYWELL		SK2.5		2.5mm ²		5 7	YE60002503200		Modified		
15		Wiring terminal board		HONEYWELL		GK2.5		2.5mm ² PE		1	YE60002503400				
16		Terminal fittings E/GK series		HONEYWELL		E		GK series		1	YE600000003900				
<div style="display: flex; justify-content: space-between;"> 机型版本 Ver.D Notes: (1)Materials not in the control box. </div>															
				Drawer		Version		D		Title		SHD-75EB		D	
				Designer		Approved by				Elec. Parts List 1		SHD-75EB-GB-400V-D-3		D	
				Proofread by		Date		20201208		 信易电热机械股份有限公司 Shini Plastics Technologies, Inc.		Scale		Page 3	
				Checked by								Standard		GB	
Mark		Before modification		After modification		Modified by		Modify date				Voltage		3φ/N/400V	
1		2		3		4		5		6		7		8	

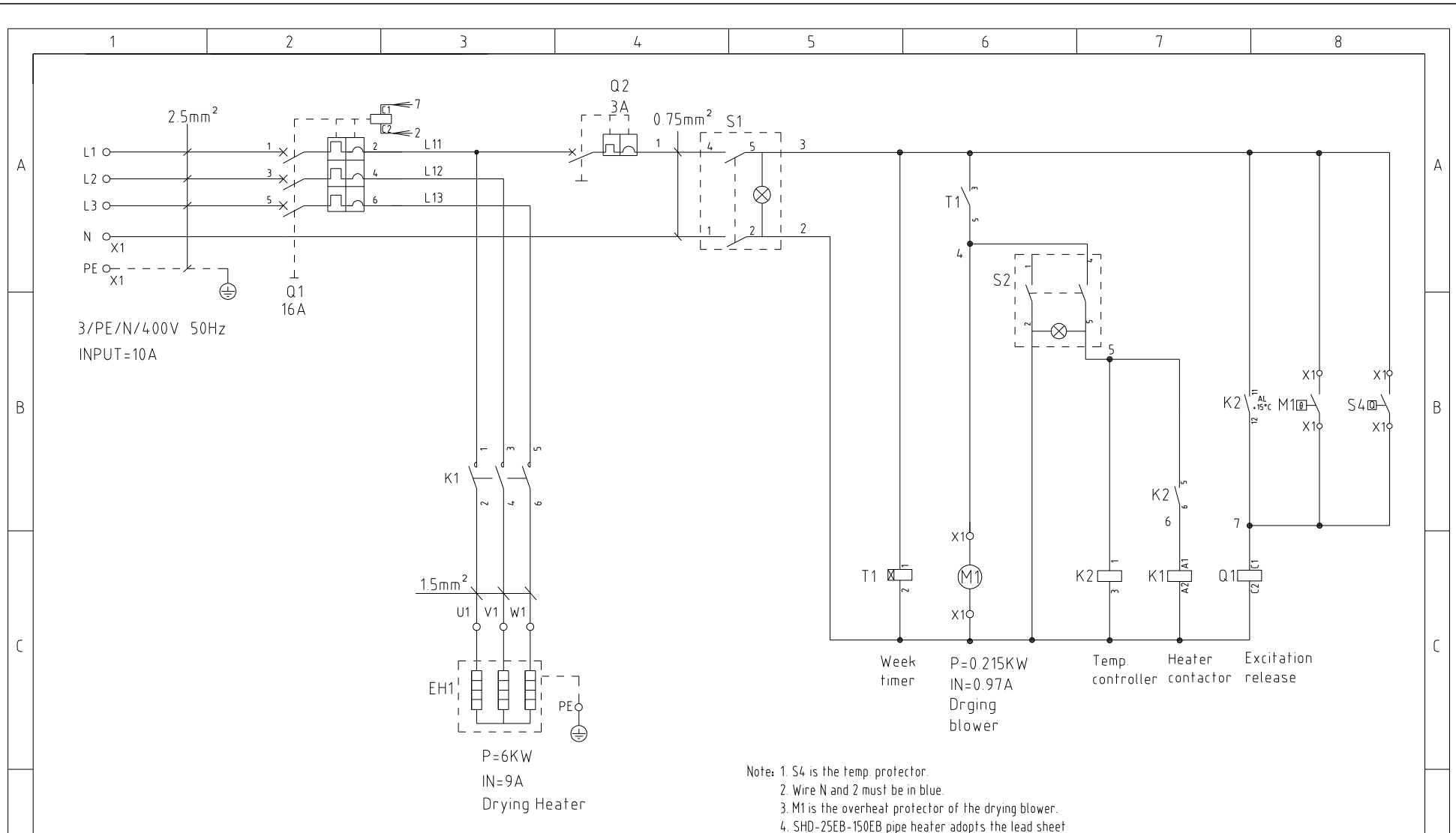

Ver.C

Mark	Before modification	After modification	Modified by	Modify date	Checked by	Date	20201020

Title	SHD-100EB Electrical Principle	Drawing NO.	SHD-100EB-GB-400V-C-1	Scale		Page	1
				Standard	GB	Totally	3 Pages
				Voltage	3φ/N/400V		
				Frequency	50Hz		



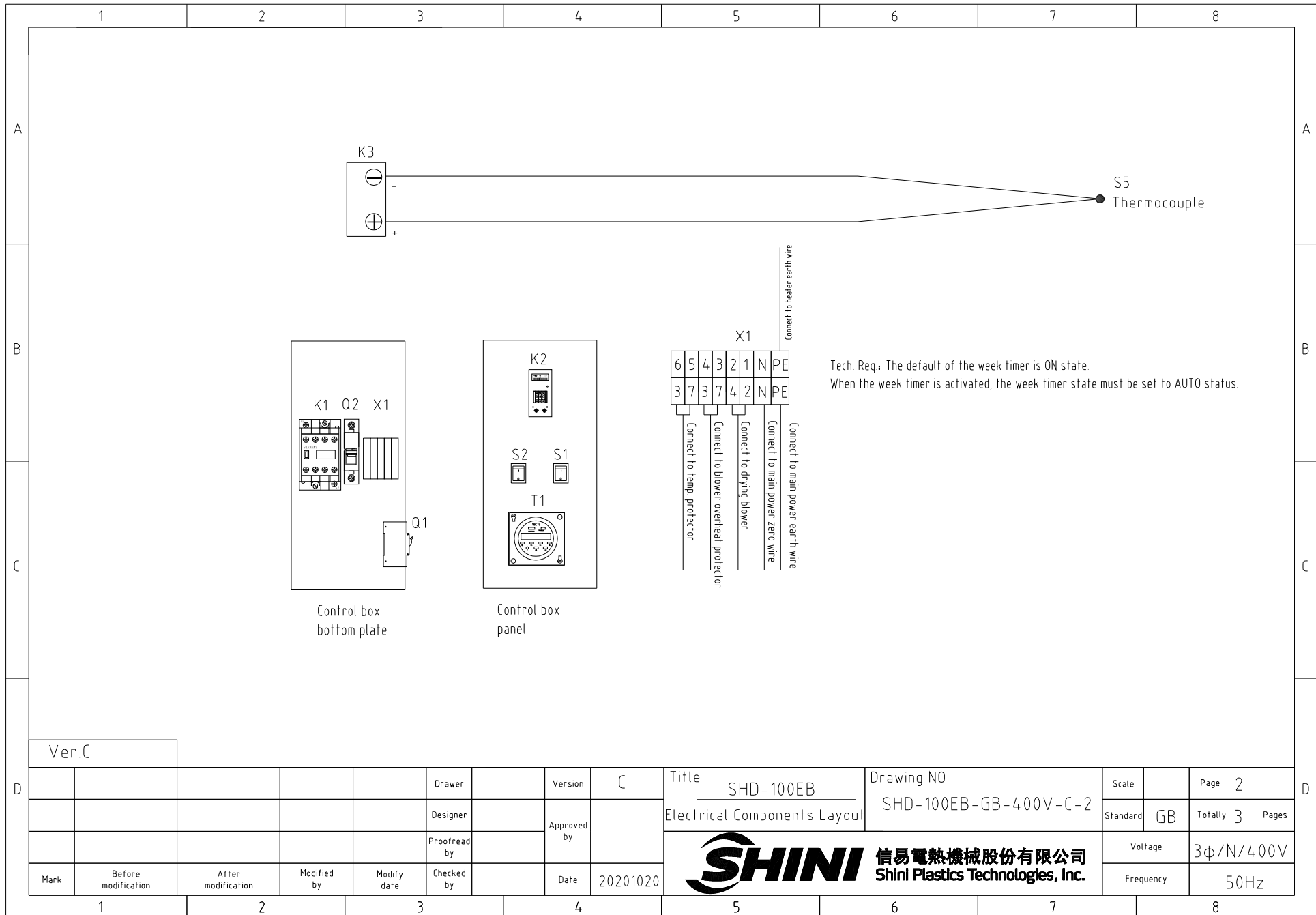

Ver.C

Ver.C					Drawer	Version	C	Title	SHD-100EB	Drawing NO.	Scale	Page	2	
					Designer	Approved by		Electrical Components Layout	SHD-100EB-GB-400V-C-2	Standard	GB	Totally	3 Pages	
					Proofread by			 信易電熱機械股份有限公司 Shini Plastics Technologies, Inc.					Voltage	3φ/N/400V
Mark	Before modification	After modification	Modified by	Modify date	Checked by	Date	20201020						Frequency	50Hz

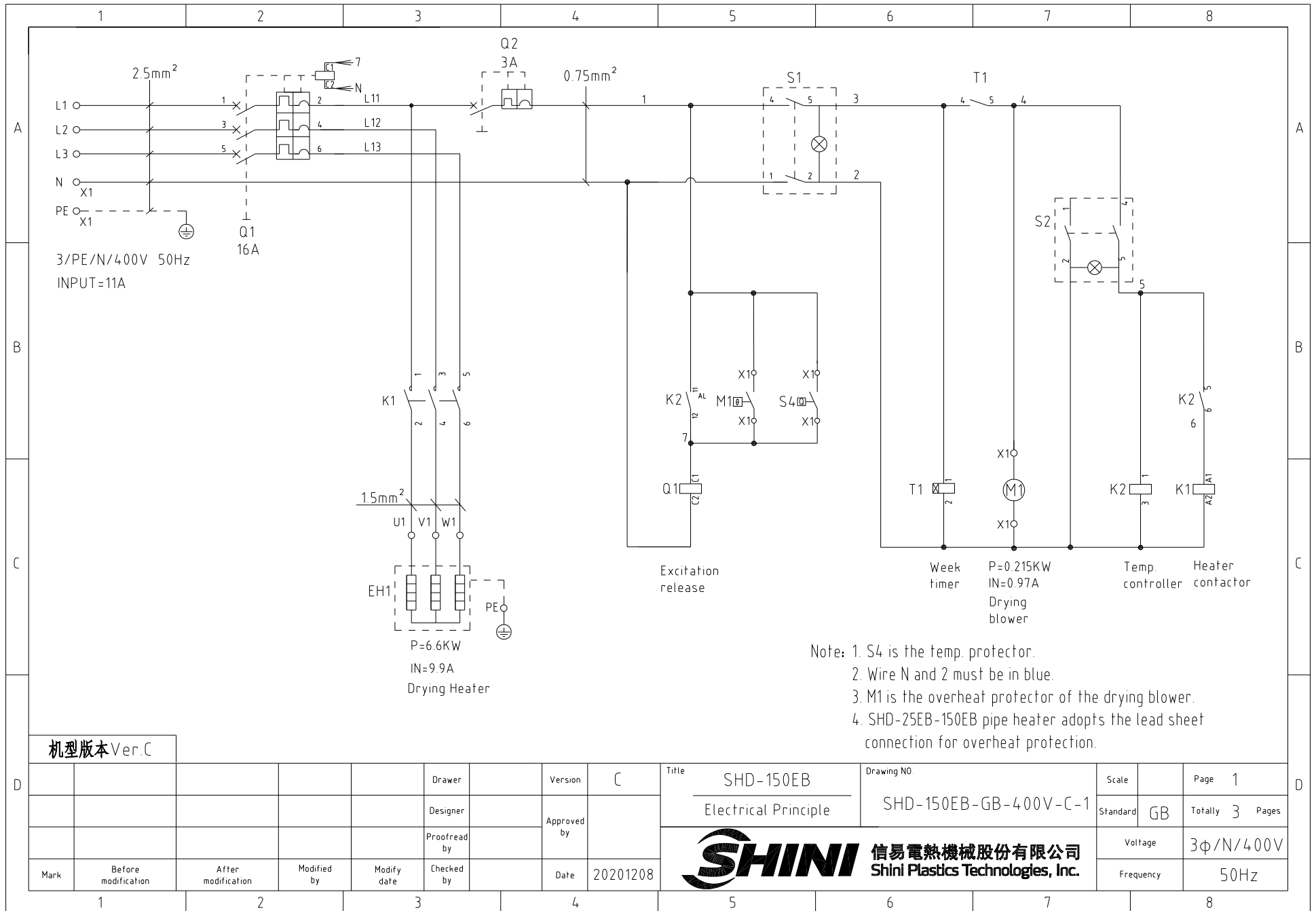

机型版本 Ver.C

					Drawer	Version	C	Title	SHD-150EB	Drawing NO	Scale	Page	1
					Designer	Approved by		Electrical Principle	SHD-150EB-GB-400V-C-1	Standard	GB	Totally	3 Pages
					Proofread by	Date	20201208	 信易電熱機械股份有限公司 Shini Plastics Technologies, Inc.		Voltage	3φ/N/400V		
Mark	Before modification	After modification	Modified by	Modify date	Checked by		Frequency			50Hz			

1 2 3 4 5 6 7 8

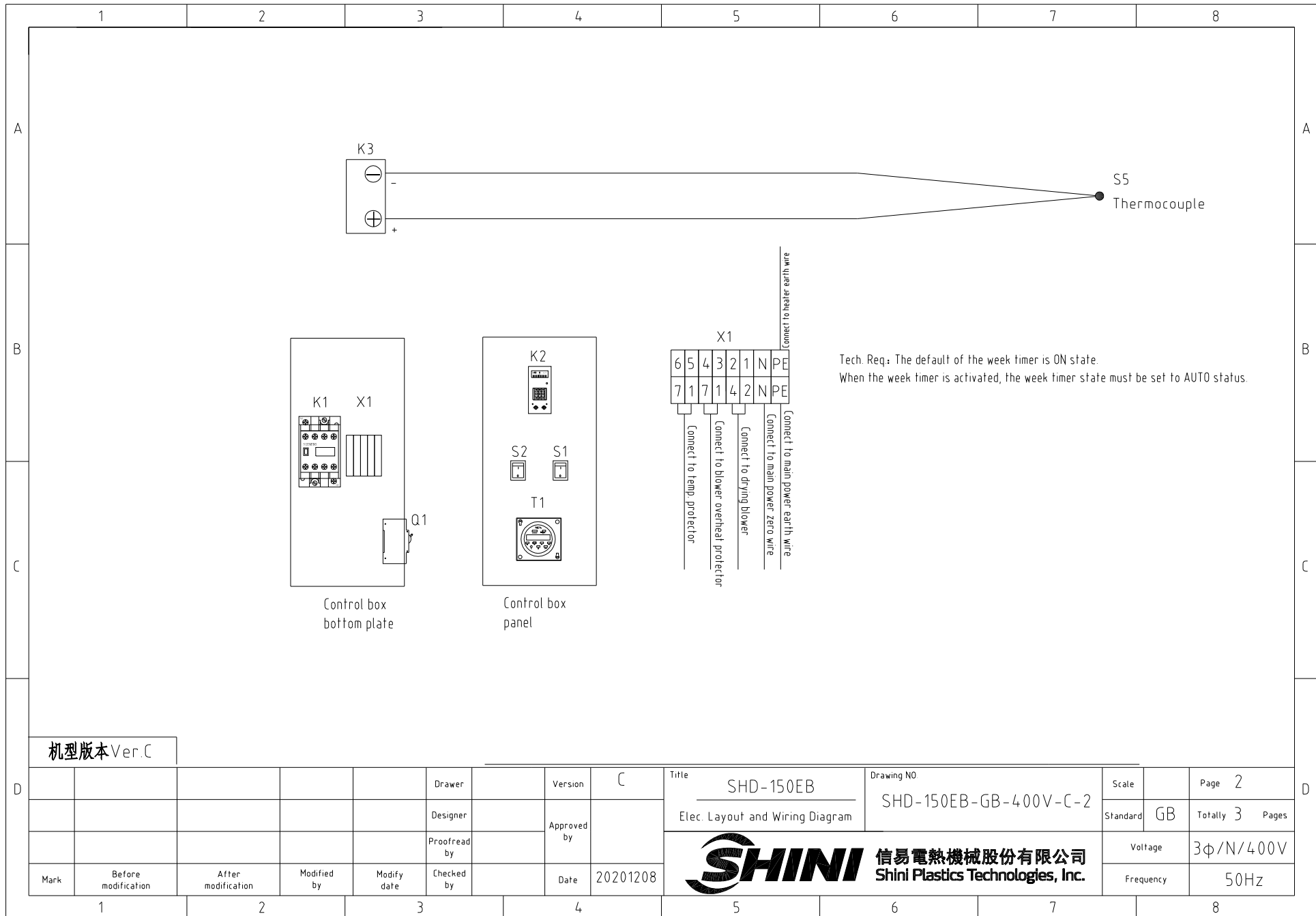

机型版本 Ver.C

					Drawer	Version	C	Title	SHD-150EB	Drawing NO	SHD-150EB-GB-400V-C-2	Scale	Page	2	
					Designer	Approved by		Elec. Layout and Wiring Diagram				Standard	GB	Totally	3 Pages
					Proofread by			 信易電熱機械股份有限公司 Shini Plastics Technologies, Inc.				Voltage	3φ/N/400V		
Mark	Before modification	After modification	Modified by	Modify date	Checked by	Date	20201208					Frequency	50Hz		

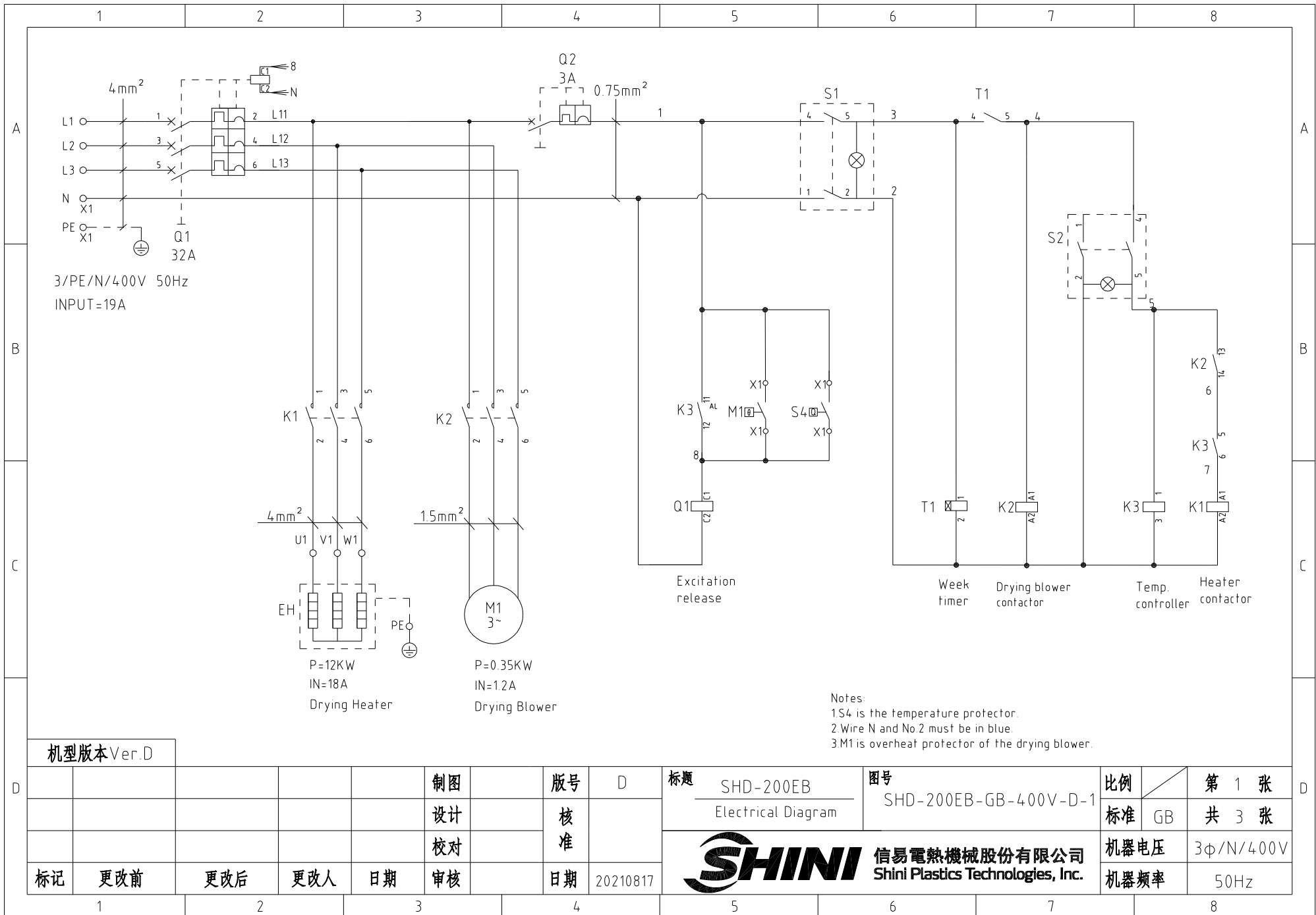

机型版本 Ver.D

制图	版号	D	标题	SHD-200EB Electrical Diagram	图号	SHD-200EB-GB-400V-D-1	比例	第 1 张
设计	核准		标准	GB	机器电压	3φ/N/400V	共 3 张	
校对	核准		机器频率	50Hz				
标记	更改前	更改后	更改人	日期	20210817			



信易電熱機械股份有限公司
Shini Plastics Technologies, Inc.

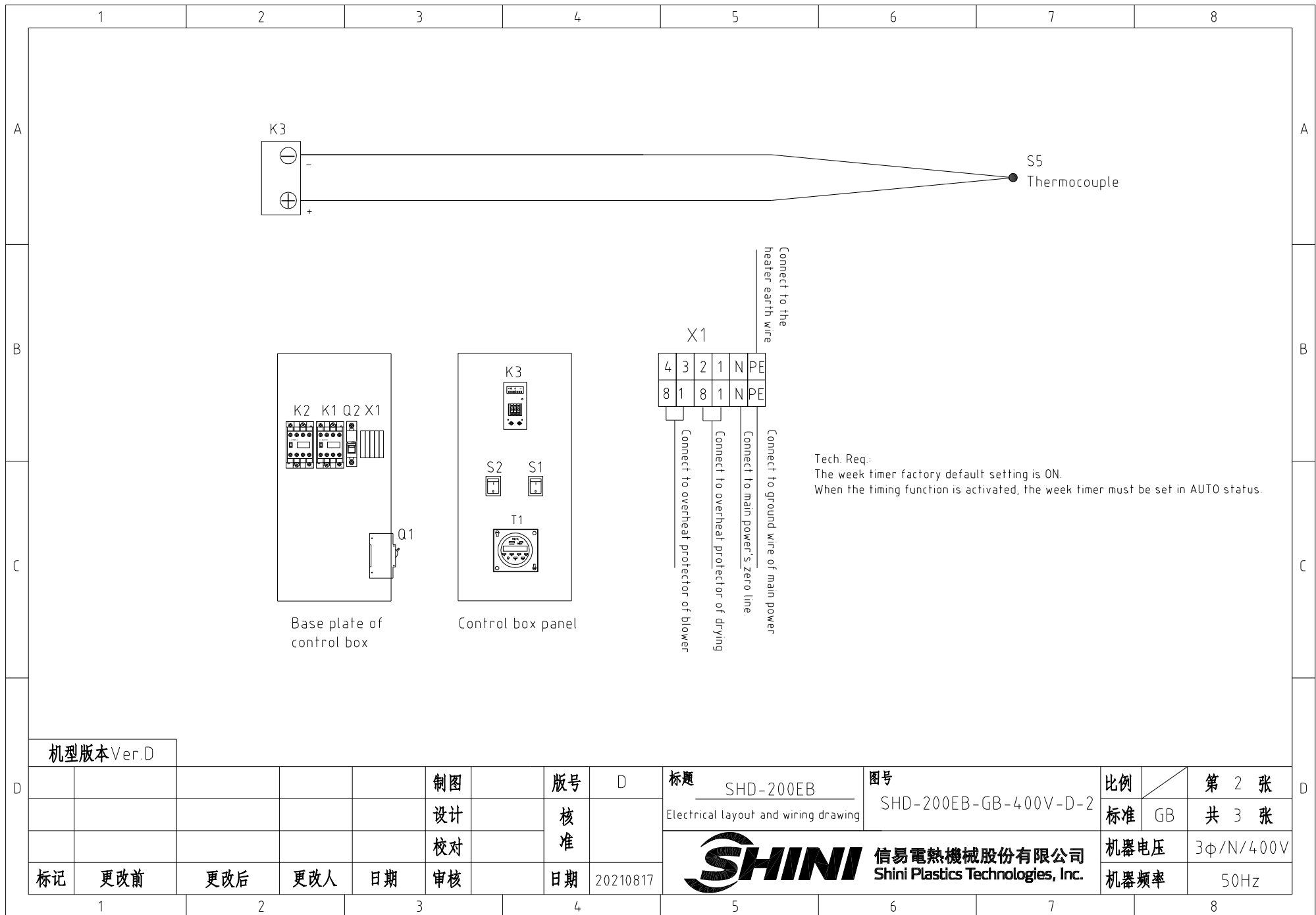

机型版本 Ver.D

					制图	版号	D	标题	SHD-200EB	图号	SHD-200EB-GB-400V-D-2	比例	第 2 张
					设计	核准		Electrical layout and wiring drawing			标准	GB	共 3 张
					校对			信易電熱機械股份有限公司 Shini Plastics Technologies, Inc.			机器电压	3φ/N/400V	
标记	更改前	更改后	更改人	日期	审核	日期	20210817				机器频率	50Hz	

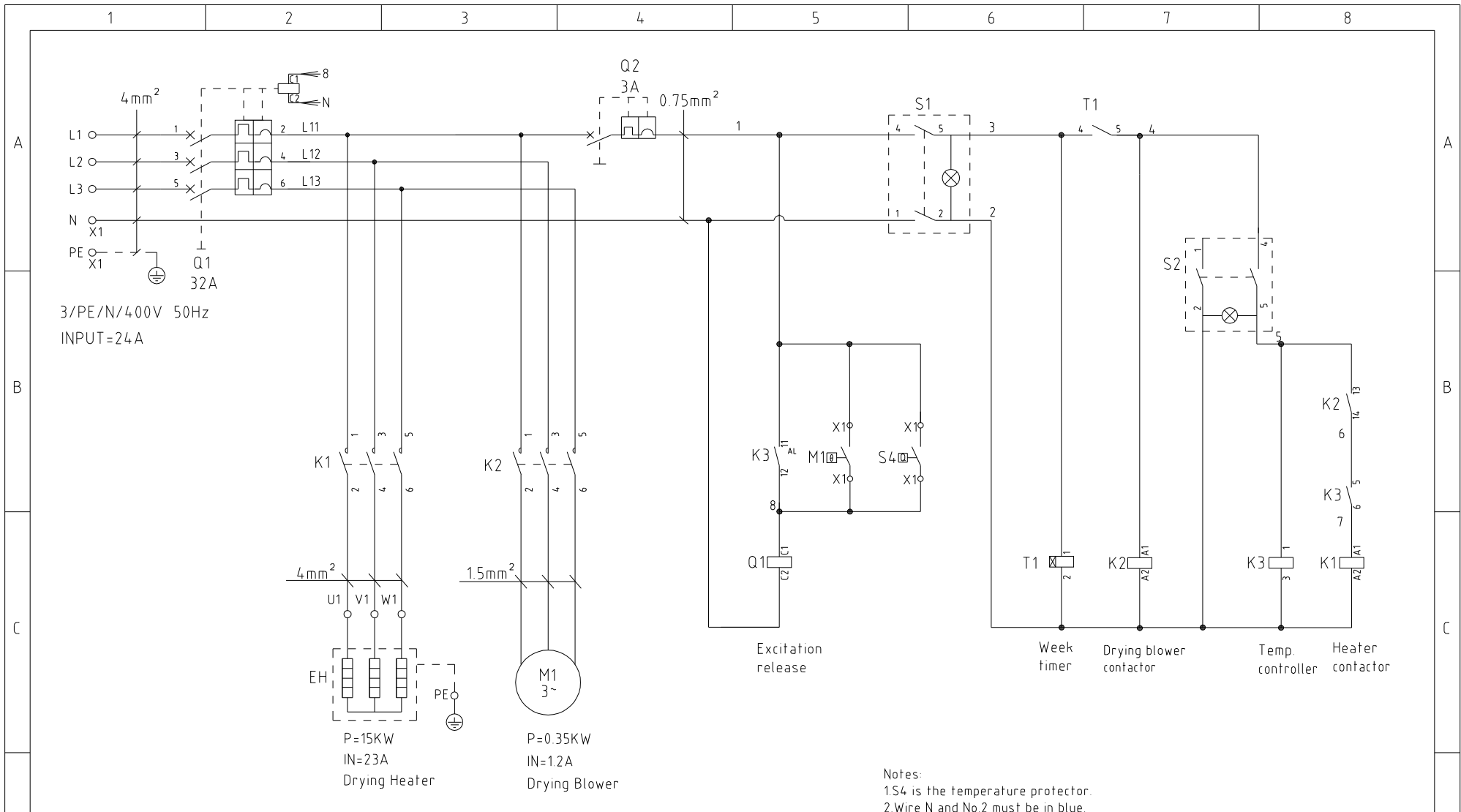

机型版本 Ver.D

				制图		版号		D		标题		图号		比例		第 1 张			
				设计		核				SHD-300EB		SHD-300EB-GB-400V-D-1		标准		共 3 张			
				校对		准				Electrical Diagram				GB					
标记		更改前		更改后		更改人		日期		20210817		SHINI 信易電熱機械股份有限公司 Shini Plastics Technologies, Inc.		机器电压		3φ/N/400V			
1		2		3		4		5		6		7		8		机器频率		50Hz	

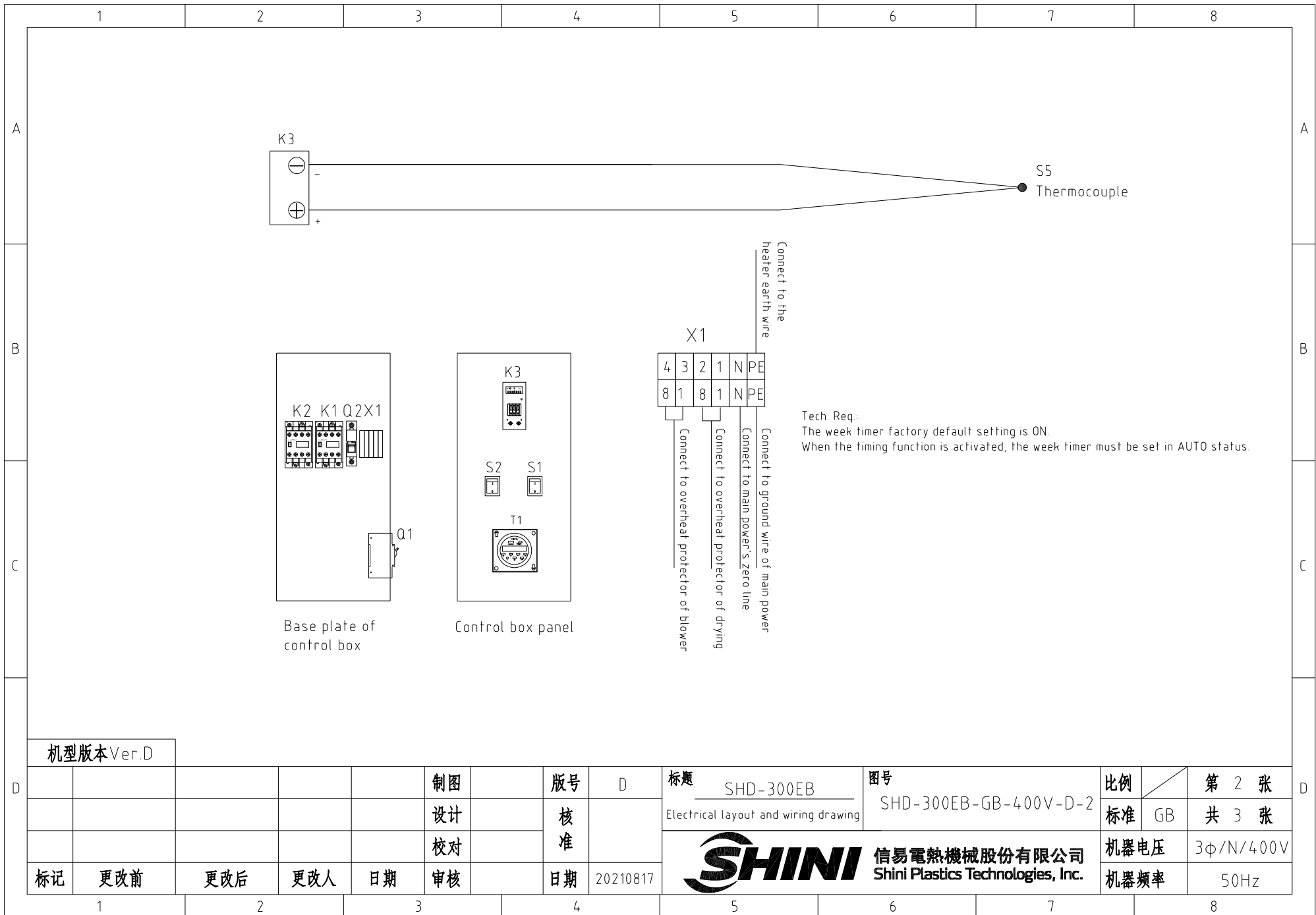

机型版本 Ver.D

				制图		版号	D	标题	SHD-300EB	图号	SHD-300EB-GB-400V-D-2	比例	第 2 张
				设计		核准		Electrical layout and wiring drawing	SHINI 信易電熱機械股份有限公司 Shini Plastics Technologies, Inc.	标准	GB	共 3 张	
				校对		日期	20210817			机器电压	3φ/N/400V		
标记	更改前	更改后	更改人	日期	审核					机器频率	50Hz		

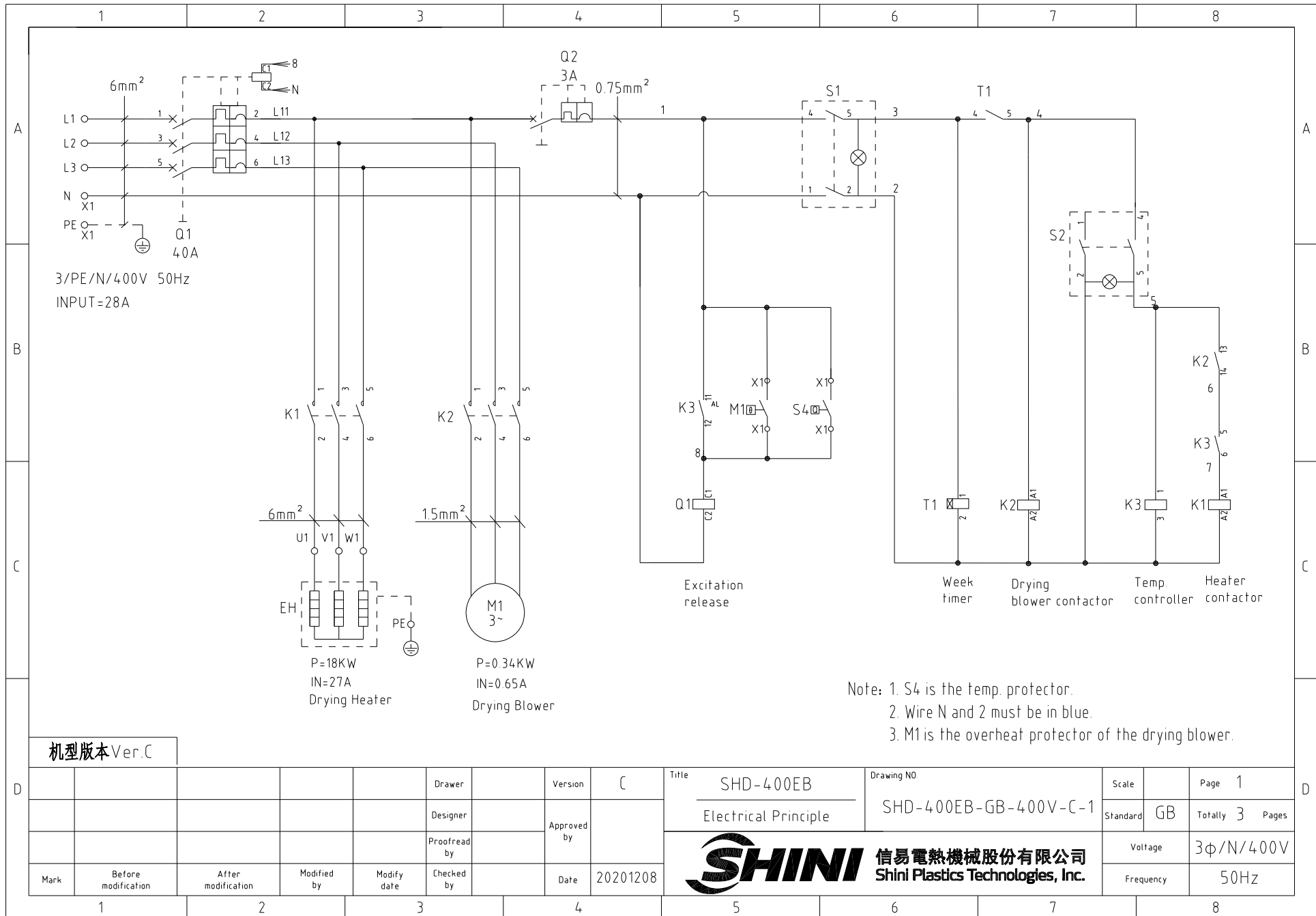

机型版本 Ver.C

Mark	Before modification	After modification	Modified by	Modify date	Checked by	Date	20201208

Title	SHD-400EB	Drawing NO	SHD-400EB-GB-400V-C-1	Scale	Page 1
	Electrical Principle			Standard	Totally 3 Pages
 信易電熱機械股份有限公司 Shini Plastics Technologies, Inc.				Voltage	3φ/N/400V
				Frequency	50Hz

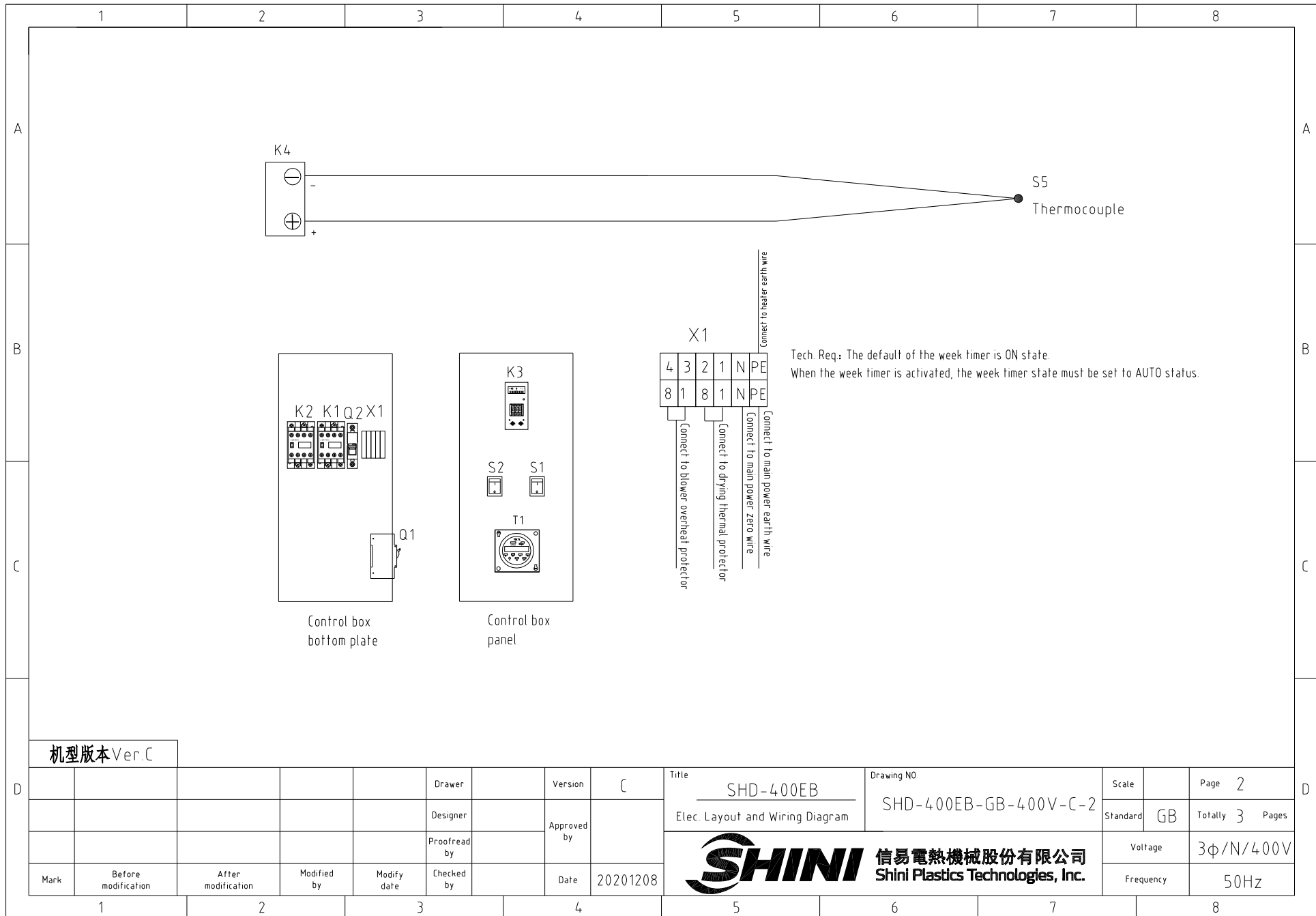

机型版本 Ver.C

					Drawer	Version	C	Title	SHD-400EB Elec. Layout and Wiring Diagram	Drawing NO	SHD-400EB-GB-400V-C-2	Scale	Page	2
					Designer	Approved by				Standard	GB	Totally	3	Pages
					Proofread by	Date	20201208	 信易電熱機械股份有限公司 Shini Plastics Technologies, Inc.		Voltage		3φ/N/400V		
Mark	Before modification	After modification	Modified by	Modify date	Checked by					Frequency		50Hz		

1 2 3 4 5 6 7 8

1		2		3		4		5		6		7		8					
NO.	Symbol	Name		Manufacturer		Type		Specification		Number	Material number		Remark						
1	Q1	Circuit breaker		TECO		BM-63C/3040S		40A 3P		1	YE40304003000								
2		Excitation release		YIJIN		MX		110V-400V 50/60Hz		1	YE40023560000								
3	Q2	Circuit breaker		TECO		BM-63C/1003S		3A 1P		1	YE40100203000								
4	K1	Contactor		SIEMENS		3RT6028-1AN20		220V 50/60Hz		1	YE00602822000								
5	K2	Contactor		SIEMENS		3RT6015-1AN21		220V 50/60Hz		1	YE00601521000								
6	K3	Temp. controller		RONGDA		0-199℃		110V/220V 50/60Hz		1	YE85019900300								
7	T1	周定时器/week Timer		SHINI		24H A-TB-72-D		230V 50/60Hz		1	YE86061900100		Cancel						
8	T1	Week timer		TBCTL		CN101		200V/250V 50/60Hz		1	YE86101000100		Newly increased						
9		Week timer housing		TBCTL		----		----		1	YR40101000100		Newly increased						
10	S1 S2	Alternative switch		ZHONGXUN		T120/55		4P (WH)		2	YE10210400000								
11	S4	Overheat protector		TONGBAO		KSD301-105		15A		1	----		New (1)						
12	S5	Thermocouple		SHINI		K TYPE		----		1	----		(1)						
13	M1	Blower		LONGFENG		0.34kW		400V 50/60Hz		1	----		(1)						
14	EH1	Heater		SHINI		18KW		400V 50/60Hz		1	----		(1)						
15	X1	Terminal board		Honeywell		SK25		2.5mm ²		4	YE60002503200								
16		Terminal board		Honeywell		GK6		6mm ²		1	YE60000603200								
17		Wiring terminal board		Honeywell		GK6PE		6mm ² PE		1	YE60000603500								
18		Terminal fittings E/GK series		Honeywell		E		GK series		2	YE60000003900								
机型版本 Ver.C		Notes: (1)Materials not in the control box.																	
				Drawer		Version		C		Title		SHD-400EB		Drawing NO		Scale		Page 3	
				Designer		Approved by				Elec. Parts List 1		SHD-400EB-GB-400V-C-3		Standard		GB		Totally 3 Pages	
				Proofread by		Date		20201208		 信易電熱機械股份有限公司 Shini Plastics Technologies, Inc.		Voltage		3φ/N/400V					
Mark		Before modification		After modification		Modified by		Modify date				Checked by		Frequency		50Hz			
1		2		3		4		5		6		7		8					

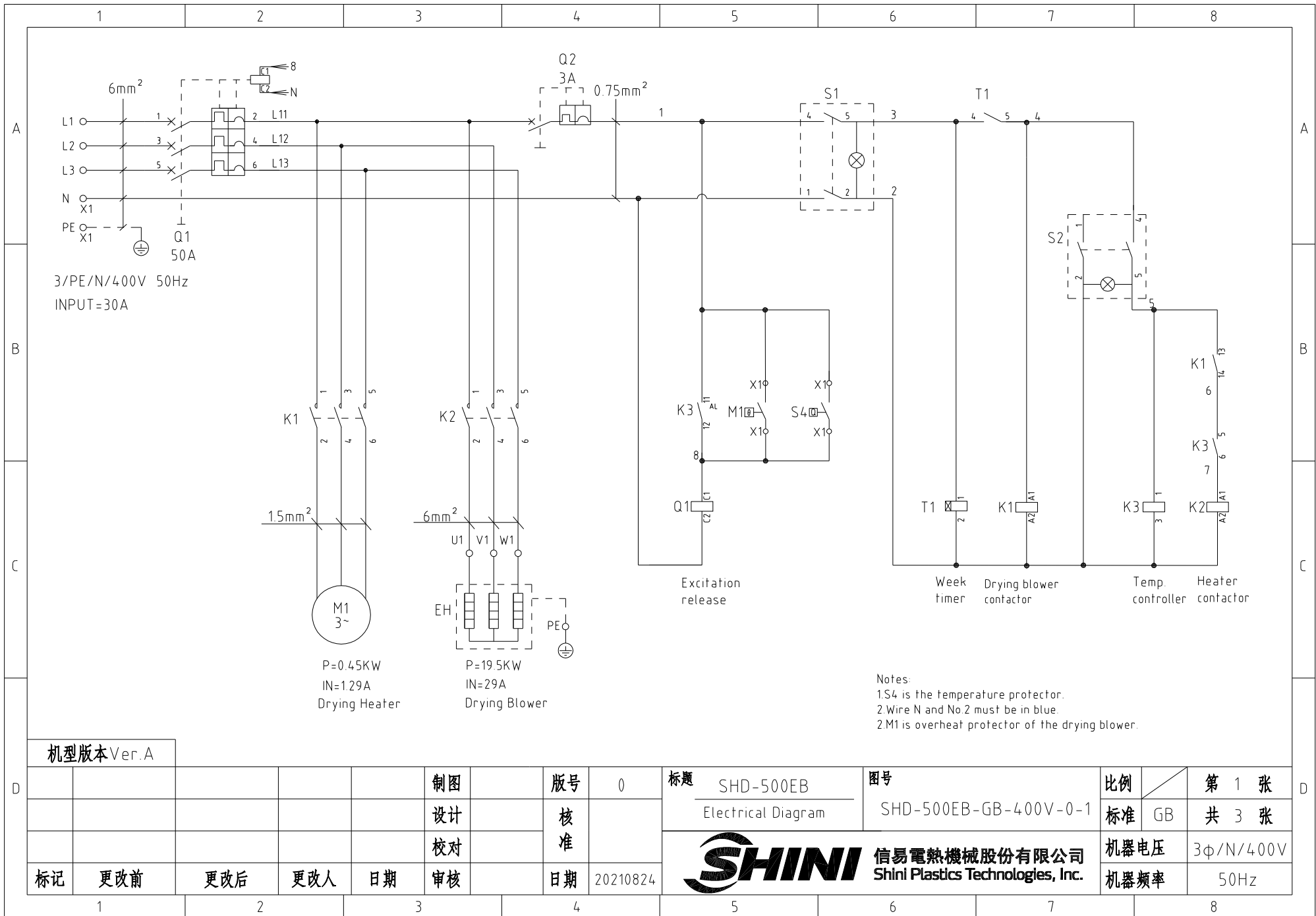

机型版本 Ver.A

					制图	版号	0	标题	SHD-500EB	图号	比例	第 1 张
					设计	核准		Electrical Diagram	SHD-500EB-GB-400V-0-1	标准	GB	共 3 张
					校对	核准		 信易電熱機械股份有限公司 Shini Plastics Technologies, Inc.		机器电压	3φ/N/400V	
标记	更改前	更改后	更改人	日期	审核	日期	20210824			机器频率	50Hz	

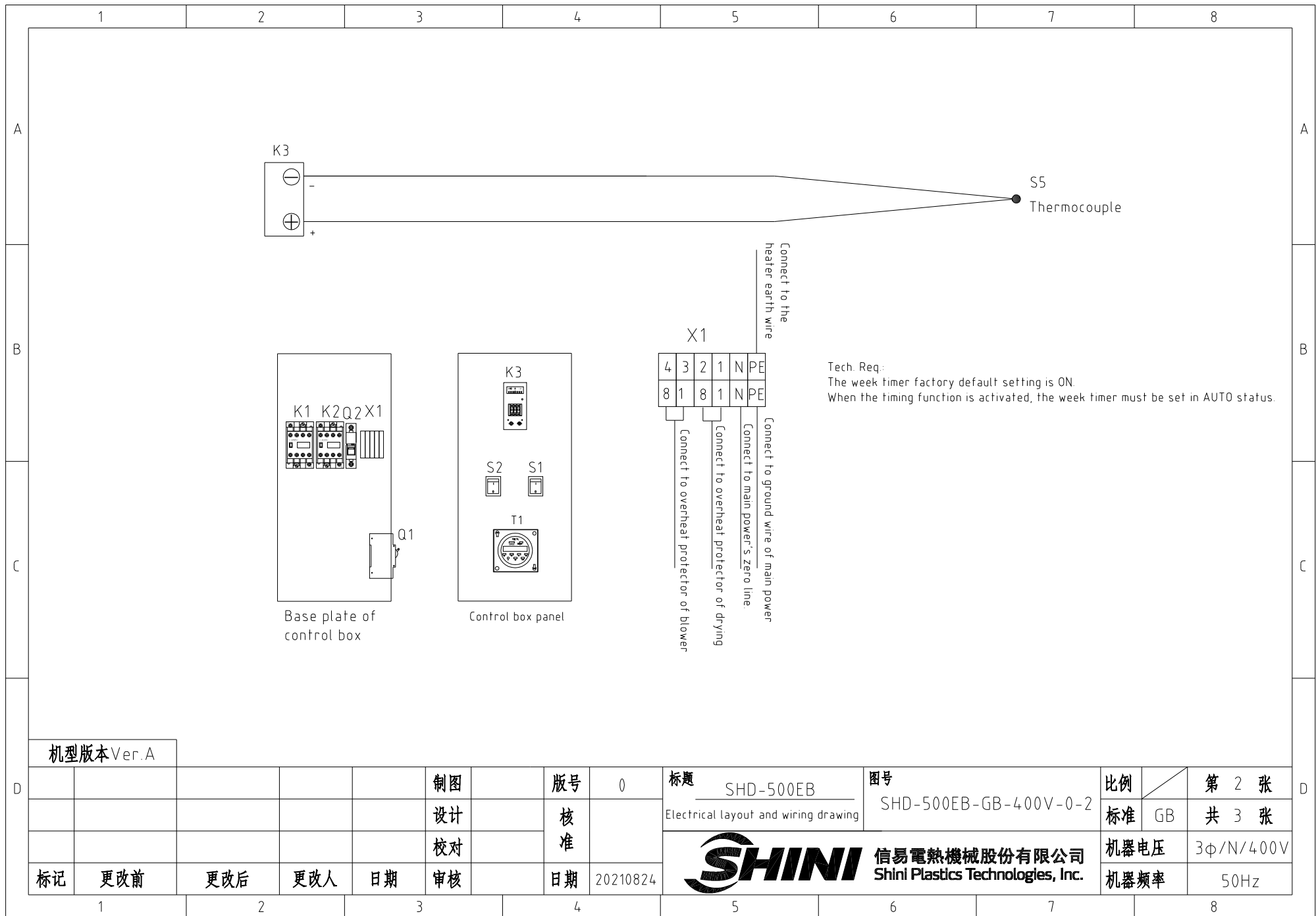

机型版本 Ver.A

					制图		版号	0	标题	SHD-500EB	图号	SHD-500EB-GB-400V-0-2	比例	第 2 张	
					设计		核		Electrical layout and wiring drawing				标准	GB	共 3 张
					校对		准		 信易電熱機械股份有限公司 Shini Plastics Technologies, Inc.				机器电压	3φ/N/400V	
标记	更改前	更改后	更改人	日期	审核	日期	20210824	机器频率					50Hz		

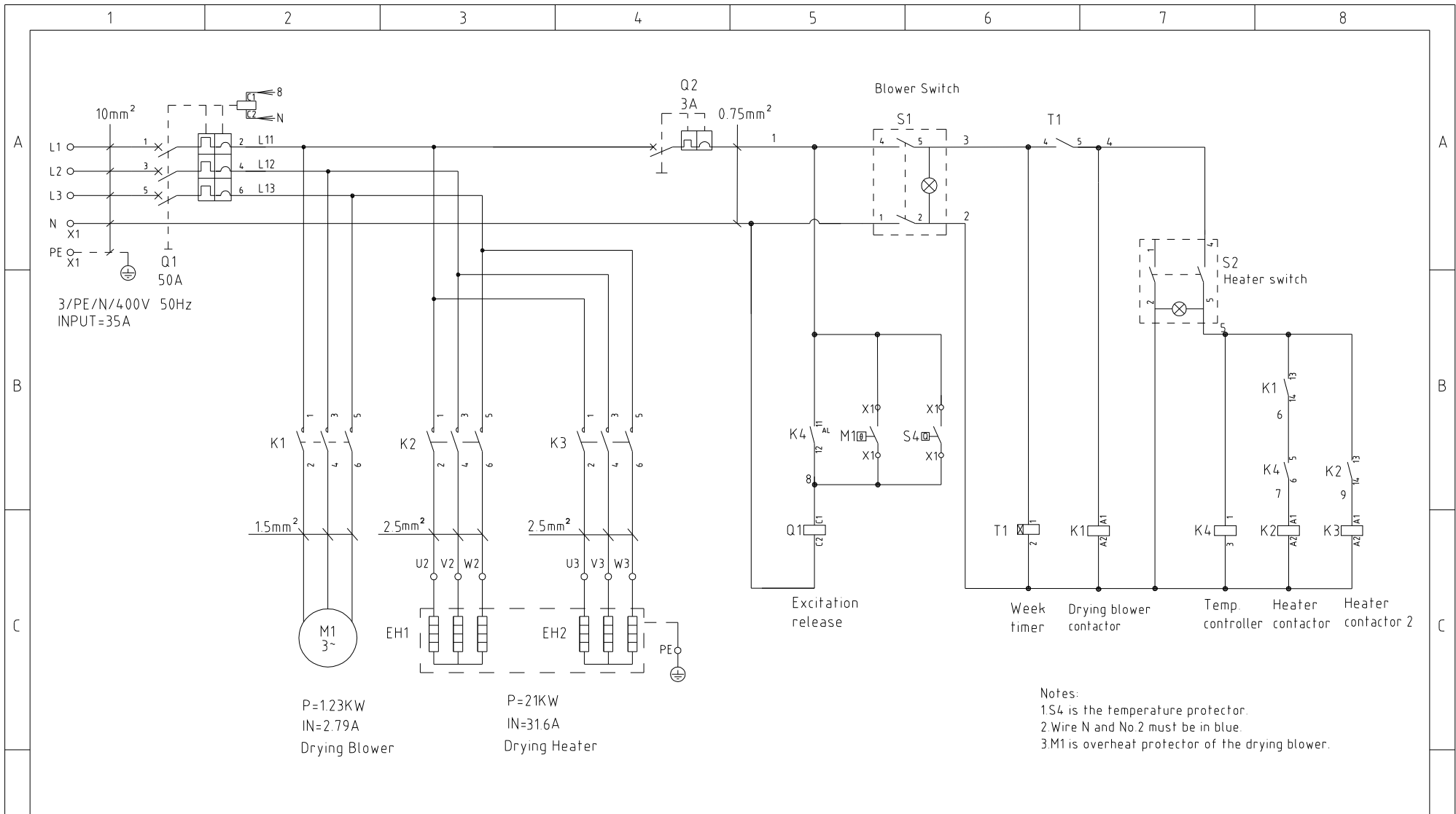

P=1.23KW
IN=2.79A
Drying Blower

P=21KW
IN=31.6A
Drying Heater

Notes:
1.S4 is the temperature protector.
2.Wire N and No 2 must be in blue.
3.M1 is overheat protector of the drying blower.

机型版本 Ver.A

				制图		版本号		标题		图号		比例		第 1 张	
				设计		核 准		SHD-600EB		SHD-600EB-GB-400V-0-1		标准 GB		共 3 张	
				校对				Electrical Diagram				机器电压		3φ/N/400V	
标记		更改前		更改后		更改人		日期		20210813		机器频率		50Hz	
1		2		3		4		5		6		7		8	



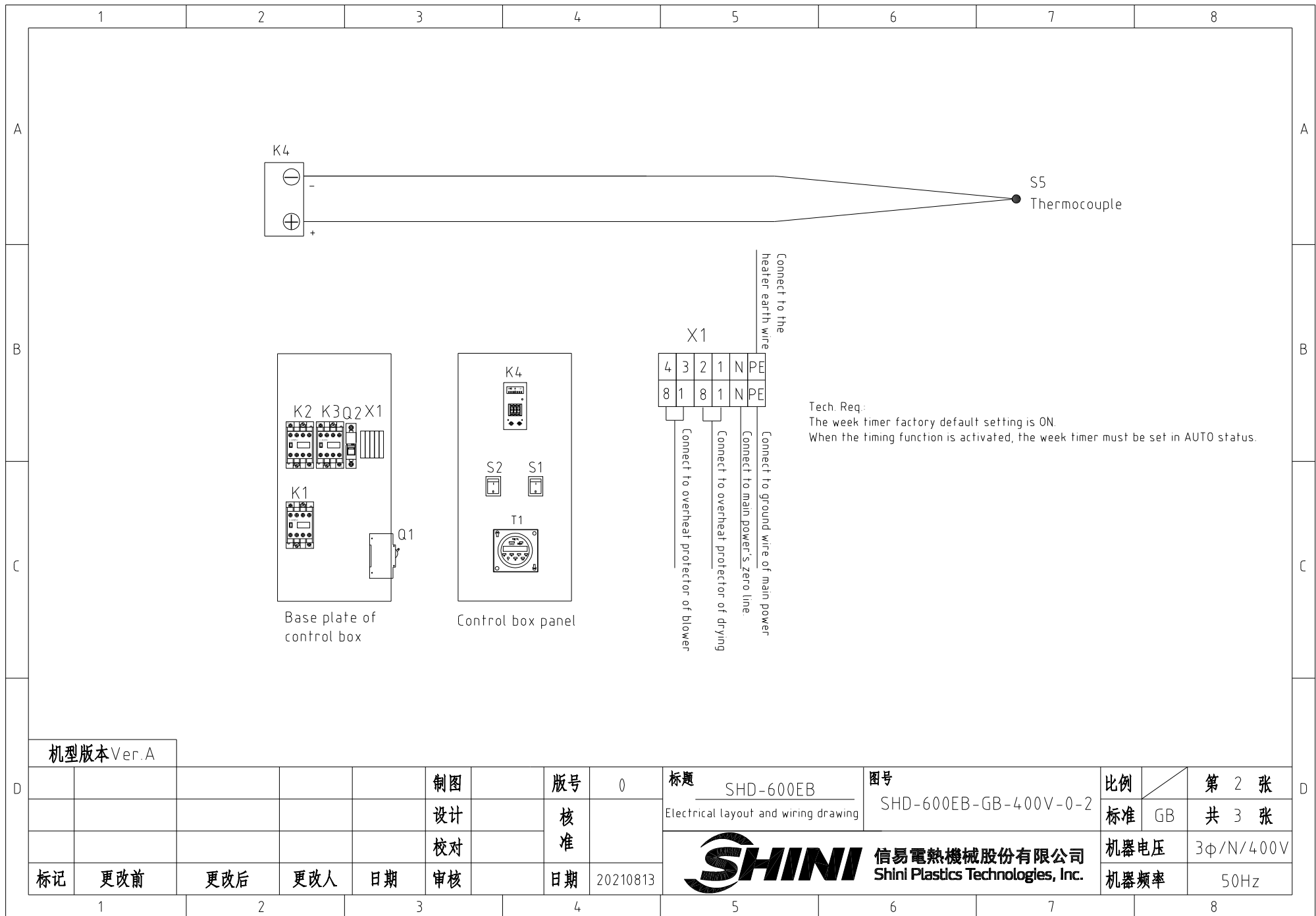

机型版本 Ver.A

				制图		版号		标题		图号		比例		第 2 张	
				设计		0		SHD-600EB		SHD-600EB-GB-400V-0-2		标准 GB		共 3 张	
				校对		核准		Electrical layout and wiring drawing				机器电压		3φ/N/400V	
标记		更改前		更改后		更改人		日期		20210813		机器频率		50Hz	



