



Mini Dehumidifying Dryer

MDD-40U/20H



Refer carefully to this manual before operation.

MDD Series

■ Coding Principle

MDD-xxU/xxH

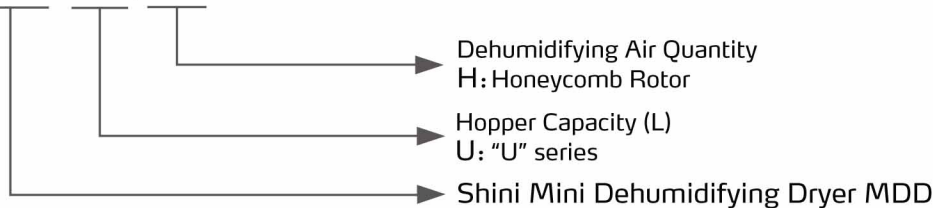

■ Features

- Adopt molecular sieve structure honeycomb rotor, which provides low dew-point dry air that can reach -40°C under ideal conditions
- Dehumidifying and drying functions are integrated into a single unit
- The standard microprocessor controller with a temperature-control precision of $+1^{\circ}\text{C}$
- It is equipped with a weekly timer to achieve auto operation
- Equipped with RS485 communication interface
- Adopt a 4.3" touch panel for an intuitive display and easy operation
- USB interface can record the data and back up local data in real-time
- New special gear transmission can eliminate the honeycomb errors to avoid slipping and tough installation caused by conventional belt drives.
- When using optional dew point meter, the dew point temp. control can control the regeneration temp. heating based on the set dew point, so as to save the energy.

The built-in adaptive energy-saving drying function can adjust the drying airflow and temp. according to different materials and outputs, thus achieving the purpose of energy-saving and preventing material from excessive drying;

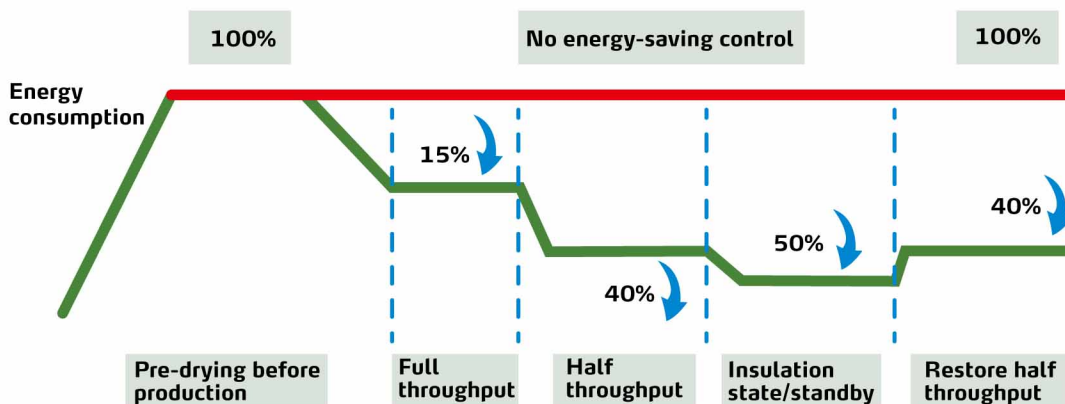

■ Options

- Entry-level dew point monitor, and add "YD" at the end of the model code.
- VAISALA dew point monitor, and add "D" at the end of the model code.

Application

MDD dehumidifying dryers integrate dehumidifying and drying into a single unit. It specially processes engineering and hygroscopic plastic materials, such as PC and PBT. The dryer is directly mounted on the plastic manufacturing unit to provide real-time dehumidifying and drying.



Working Principle

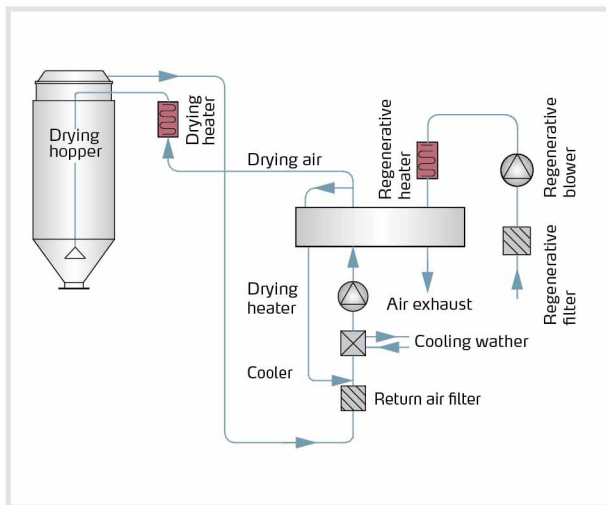

Outline Drawings

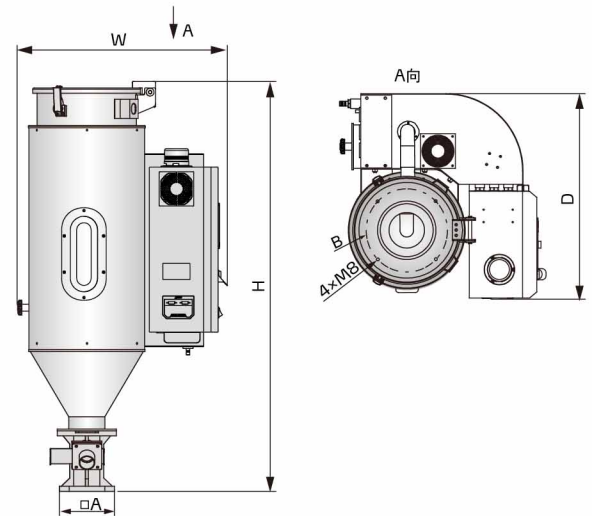

Specifications

Model	Regen. Heater (kW)	Regen. Blower (kW)	Drying Heater (kW)	Drying Blower (kW)	Dry Air Quantity (m ³ /hr)	Hopper (L)	Dimension(mm) H×W×D	A(mm)	B(mm)
MDD-20U/20H	1.2	0.18	0.85	0.192	20	20	835×565×574	154	Φ231
MDD-40U/20H	1.2	0.18	0.85	0.192	20	40	1153×583×578	154	Φ231
MDD-80U/30H	1.2	0.18	1.2	1.4	30	80	1439×653×672	154	Φ254.5

Notes: 1)Power 3Φ, 230/400/460/575VAC, 50/60Hz.
2)Max. drying temp. is 140°C.

We reserve the right to change specifications without prior notice.

Shini Group

Addr: No. 23, Minhe St., Shulin Dist.,
New Taipei, Taiwan

Tel: +886 2 2680 9119

Fax: +886 2 2680 9229

Email: shini@shini.com

Factories:

- Taiwan
- Dongguan
- Pinghu
- Ningbo
- Chongqing
- Pune

2023-10-30-04 Copyrights Reserved.

www.shini.com