

# **SCM-EB**

## **“Budget” Series Volumetric Doser**

Date: Oct., 2023

Version: Ver. B (English)



## Contents

<b>1. General Description .....</b>	<b>4</b>
1.1 Coding Principle.....	5
1.2 Features.....	5
1.3 Machine Specifications .....	7
1.3.1 Dimensions of Doser .....	7
1.3.2 Specification List.....	8
1.4 Safety Regulations.....	9
1.4.1 Safety Signs and Labels.....	9
1.5 Exemption Clause.....	10
<b>2. Structure Characteristics and Working Principle.....</b>	<b>11</b>
2.1 Working Principle .....	11
2.2 Optional Accessories .....	12
2.2.1 Main hopper .....	12
2.2.2 Mixing System .....	12
2.2.3 Heavy base .....	13
<b>3. Installation and Debugging .....</b>	<b>14</b>
3.1 Install on Extrusion or Injection Molding Machine .....	14
3.2 Power Supply Wiring.....	15
<b>4. Operation .....</b>	<b>16</b>
4.1 Control Panel (SCM).....	16
4.2 Start/Stop of the Machine .....	16
4.3 Operation Instruction.....	17
4.3.1 IMM Mode Setting .....	17
4.3.2 Extruder Mode.....	20
4.3.3 Other Function Setting.....	21
4.3.4 Other Parameters Function .....	22
4.4 Replace Dosing Screws.....	25
<b>5. Trouble Shooting.....</b>	<b>26</b>
<b>6. Maintenance and Repair .....</b>	<b>27</b>
6.1 Repair .....	27
6.2 Maintenance .....	27

6.3 Maintenance Schedule .....	27
6.3.1 About the Machine.....	27
6.3.2 Check after Installation .....	27
6.3.3 Daily Checking .....	27
6.3.4 Weekly Checking.....	27

### **Table Index**

Table 1-1: Specification List 1 .....	8
---------------------------------------	---

### **Picture Index**

Picture 1-1: Dimensions of Doser .....	7
Picture 2-1: Working principle of the single color doser.....	11
Picture 3-1: Installation of Single Color Doser .....	14
Picture 3-2: Installation of Double-color Doser .....	14
Picture 4-1: Control Panel .....	16
Picture 4-2: Replace Dosing Screws .....	25

# 1. General Description



Please read this manual carefully before installation and using of the machine to prevent damage or personal injury. SCM-EB “budget” series volumetric dosers are suitable for auto-proportional mixing of new materials, regrinds, master batch and additives. A stepping motor is coupled to a dosing screw of 12, 16, 20, and 30mm diameter to offer four models with different output ranging from 0.1 to 110kg/hr to clients. Double-color doser can be assembled from any two single color doser according to clients’ requirements.

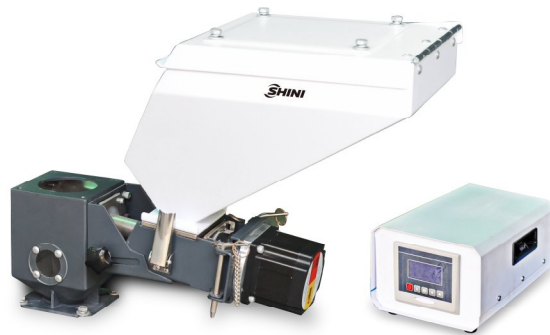

Model: Single Color Doser SCM-EB

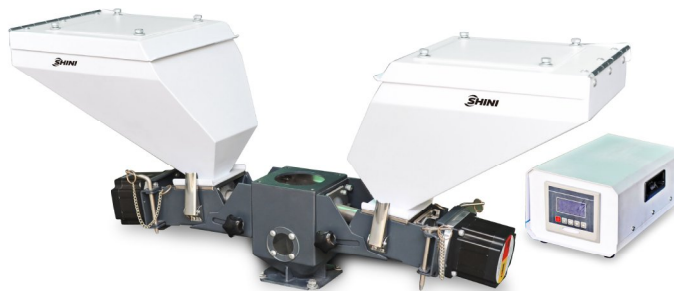

Model: Color Doser SCM-D-EB

## 1.1 Coding Principle

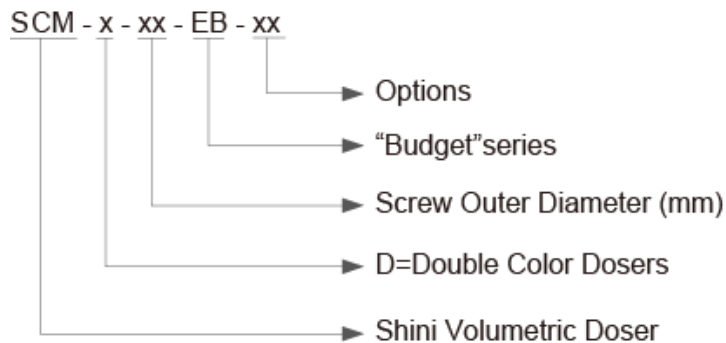

## 1.2 Features

- Dosing screws are chrome plated for durability.
- Unit is comprised of standard modules for ease of cleaning, disassembly and interchangeability.
- External signals can be directly input to control box.
- The current mode can be recorded without interrupted by power failure.
- Compulsory material cleaning makes it easier to replace masterbatch.
- Applicable on extrusion machines, just need to make a few wire replacements.
- Rotating speed can be automatically adjusted according to extruder processing speed, which maintains the fixed proportion of masterbatch.
- 50 recipes are available for permanent recording of material discharging time and finished products weight (for extruder, it is max. throughput per minute).
- Based on customers demand, mold cycles can be set to add additives periodically so that micro-metering can be achieved.
- Equipped with RS485 communication function

All service work should be carried out by a person with technical training or corresponding professional experience. The manual contains instructions for both handling and servicing. Chapter 6, which contains service instructions intended for service engineers. Other chapters contain instructions for the daily operator.

Any modifications of the machine must be approved by SHINI in order to avoid personal injury and damage to machine. We shall not be liable for any damage caused by unauthorized change of the machine.

Our company provides excellent after-sales service. Should you have any problem during using the machine, please contact the company or the local vendor.

Headquarter and Taipei factory:

Tel: (886) 2 2680 9119

Shini Plastics Technologies (Dongguan), Inc:

Tel: (86) 769 8111 6600

Shini Plastics Technologies India Pvt.Ltd.:

Tel: (91) 250 3021 166

## 1.3 Machine Specifications

### 1.3.1 Dimensions of Doser

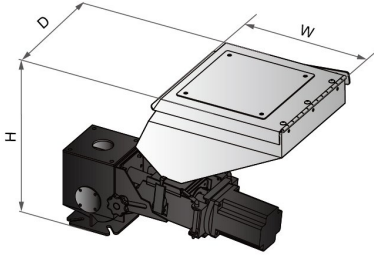

Single Color Doser

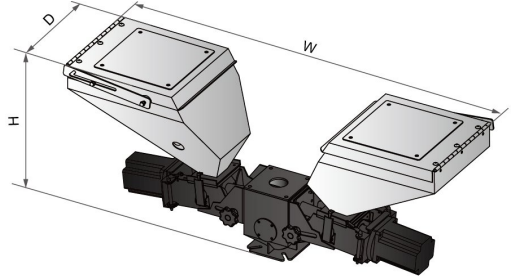

Double- color Doser

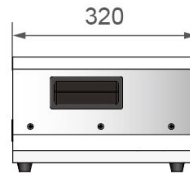
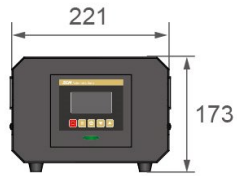

Controller

Picture 1-1: Dimensions of Doser

### 1.3.2 Specification List

Table 1-1: Specification List 1

Model	Single Color Unit				Double Color Unit
	SCM-12-EB	SCM-16-EB	SCM-20-EB	SCM-30-EB	SCM-D-EB
Ver.	A	A	A	A	A
Motor Power (kW) (50/60Hz)	0.06	0.06	0.06	0.06	0.06×2
Mixer power (kW, 50 / 60Hz)	0.25	0.25	0.25	0.25	0.25
Screw External Dia. (mm)	12	16	20	30	**
Output Capacity (kg/hr)	0.1 ~ 10	0.5 ~ 30	3 ~ 60	8 ~ 110	*
Storage Hopper (L)	10	10	10	10	10
Main Material Hopper(L)	Optional (15)	Optional (15)	Optional (15)	Optional (15)	Optional (15)
Mixer	Optional	Optional	Optional	Optional	Optional
Floor Stand	Optional	Optional	Optional	Optional	Optional
Dimensions					
H (mm)	420	420	420	420	420
W (mm)	585	585	585	585	1030
D (mm)	300	300	300	300	300
Weight (kg)	18	18	18	18	30

We reserve the right to change specifications without prior notice.

Note:

- 1) "\*" stands for the output capacity depends on model selected, data of the single color doser can be a reference.
- 2) "\*\*" stands for external dia. of screw is up to model selected.
- 3) For additional mixer, add "MS" at the end of model code.
- 4) When selecting screws with diameter of 30mm, the machine model should be followed by "L" to distinguish it from other three kinds of interchangeable screws.
- 5) All output capacities of above models are base on data from bulk density 1.2kg/L, dia. 2~3mm master batch in a test criteria of continuous running.
- 6) Main power for single color unit is 1Φ, 115 / 230V, 50 / 60Hz, but it will be 3Φ, 230 / 400 / 460 / 575VAC, 50 / 60Hz when being equipped with mixer.
- 7) When the master batch hopper is mounted with the auto conveying device, the total weight of the hopper shall not exceed 25KG (including the master batch).
- 8) When the long hopper is mounted with the auto conveying device, the total weight of the hopper shall not exceed 20KG(including the master batch).



## 1.4 Safety Regulations

Strictly abide by the following safety guide to prevent damage of the machine or personal injuries.

### 1.4.1 Safety Signs and Labels



All the electrical components should be installed by qualified electricians. Turn off the main switch and control switch during maintenance or repair.



Warning! High voltage!

This sign is attached on the cover of control box!



Warning! Be careful!

Be more careful at the place where this sign appears!



Attention!

No need for regular inspection because all the electrical parts in the control unit are fixed tightly!



Attention!

All the screws for installing electrical components in the control box are locked, which is no need of regular inspection!



Attention!

The cooling water of the SCM-H must be normal temperature water.



Warning!

Watch your hand!

The label sticks to the housing of the hopper!



Warning!

Be careful of scratch!

The label sticks to the coupling place of the screw and the metering motor!

## 1.5 Exemption Clause

The following statements clarify the responsibilities and regulations born by any buyer or user who purchases products and accessories from Shini (including employees and agents).

Shini is exempted from liability for any costs, fees, claims and losses caused by reasons below:

1. Any careless or man-made installations, operation and maintenances upon machines without referring to the Manual prior to machine using.
2. Any incidents beyond human reasonable controls, which include man-made vicious or deliberate damages or abnormal power, and machine faults caused by irresistible natural disasters including fire, flood, storm and earthquake.
3. Any operational actions that are not authorized by Shini upon machine, including adding or replacing accessories, dismantling, delivering or repairing.
4. Employing consumables or oil media that are not appointed by Shini.

## 2. Structure Characteristics and Working Principle

### 2.1 Working Principle

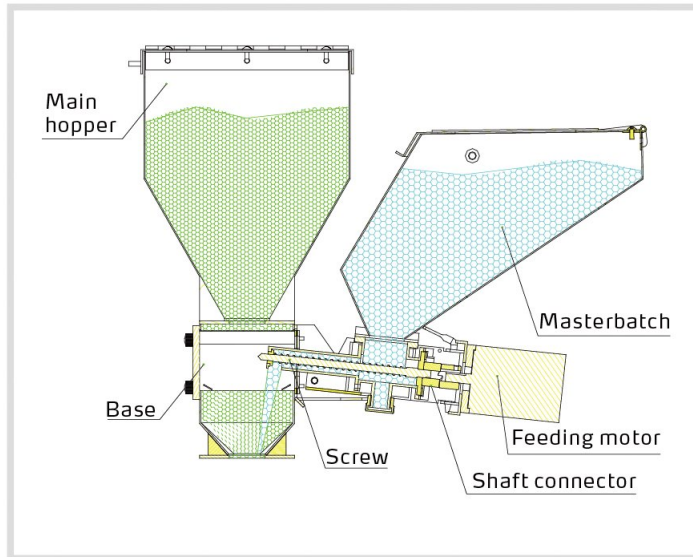

Picture 2-1: Working principle of the single color doser

Signals from control cabinet will be sent to motor, and the motor begins to work, which drives the screw rotate through the coupler. The color master batch in the hopper falls into the screw, squeezed and transported by the screw to the base, so as to achieve the purpose of accurately metering and transferring the color master batch.

## 2.2 Optional Accessories

### 2.2.1 Main hopper

The main material hopper is optional for both single and double color doser basing on customer demand.

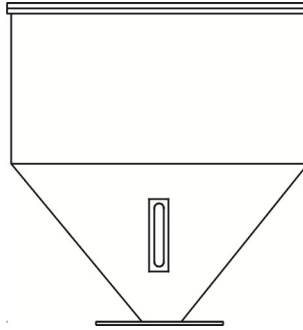

Picture 2-2: Main Hopper

### 2.2.2 Mixing System

The mixing system is optional for both single and double color doser basing on customer demand.

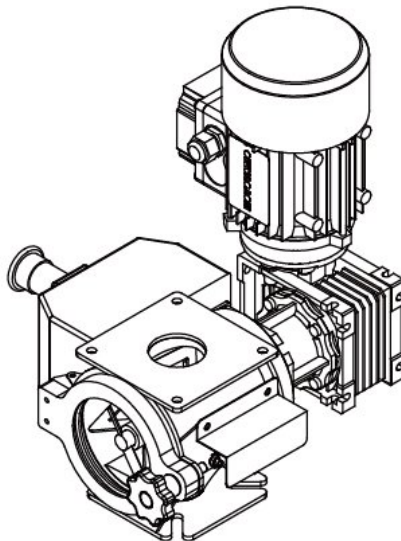

Picture 2-3: Mixing System

### 2.2.3 Heavy base

When customer requires SHD-100~300kg or SHD-160U~450U dryer, this heavy base is necessary.

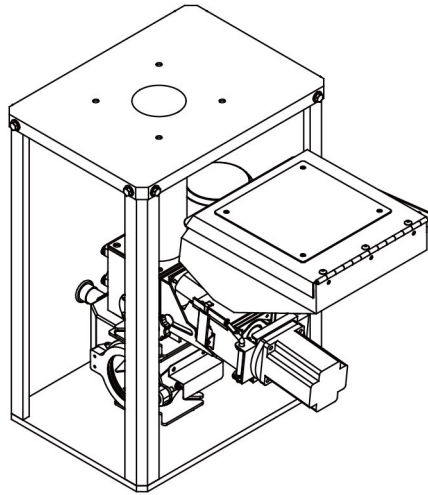

Picture 2-4: Heavy Base

### 3. Installation and Debugging

Read this chapter carefully before installation. Install the machine by following steps.

This series of models only could be applied in working environment with good ventilation.



Power supply of the machine should be done by qualified electricians!

#### 3.1 Install on Extrusion or Injection Molding Machine

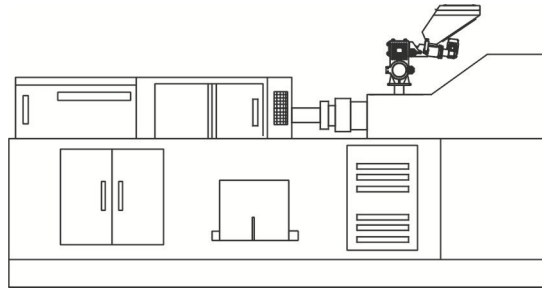

Picture 3-1: Installation of Single Color Doser

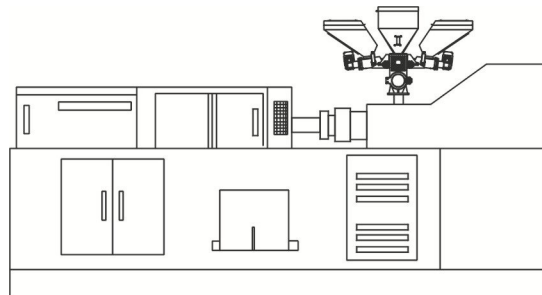

Picture 3-2: Installation of Double-color Doser

According to the specifications of mounting holes on the extruder or injection molding machine, drill 4 screw holes on the base of SCM machine. Install the whole machine on the extruder or injection molding machine by locking the 4 screws of the mounting base.

## 3.2 Power Supply Wiring

Please adjust the doser control box's power to corresponding voltage according to the customer's power specifications before operation (open the control box cover and manually dial the voltage button to select), and connect to the ground.

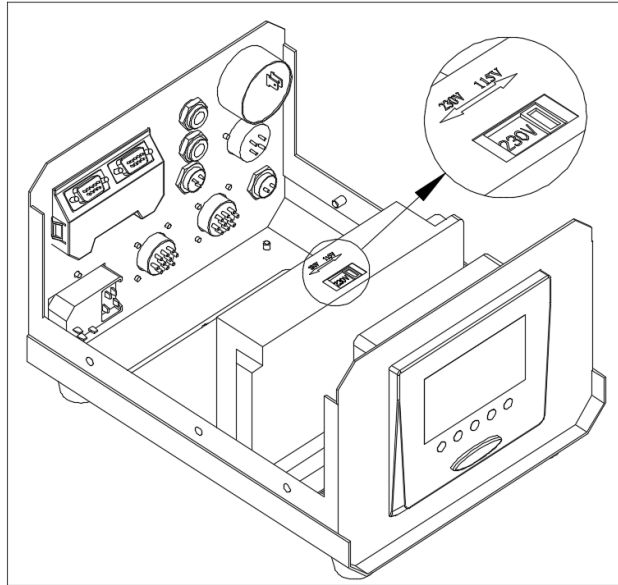

## 4. Operation

### 4.1 Control Panel (SCM)

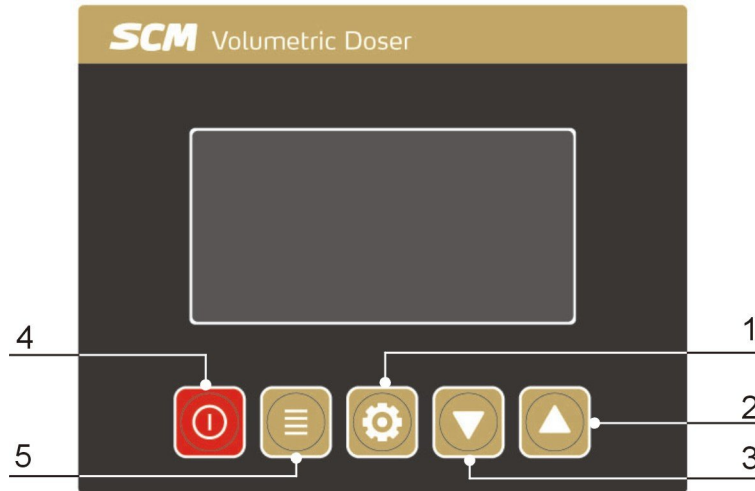

Picture 4-1: Control Panel

1. Setting key    2. Up key    3. Down key    4. Run Switch    5. Menu key

Chinese/English selection: After machine powered on, press the setting

key  for 3 secs. to switch English/Chinese.

Model Switching: When machine is in standby mode, press and hold the

 Key for 3 secs. to switch the model. Model switching is to switch between injector mode and extruder mode.

### 4.2 Start/Stop of the Machine

- 1) Check whether the power is turned on.
- 2) Turn on the main switch at the back of control box.
- 3) Press the control switch on the panel, the RUN indicator will be turned on.
- 4) After setting the parameters, machine will operate automatically if Extruder starts to run and signal gets into the doser.
- 5) Follow the reverse order to turn off.



## 4.3 Operation Instruction

Three states of machine.



The indicator has three states:

Yellow: Standby

Green: Run

Red: Alarm

### 4.3.1 IMM Mode Setting

According to the circuit diagram, when the injection machine is in the working mode (receiving the 24VDC melt signal from the injection molding machine), the machine is in the injection machine working mode after it is powered on.



#### 4.3.1.1 Parameters Set for IMM Mode

1. 50 secs. weight setting steps:

- 1) Press Menu key  till it enters the screen displaying 50 secs. weight output of screw 1.



- 2) Hold on the Setting key  for 5 secs, and it enters the screen displaying manual feeding of screw 1.



No.1 Filling  
No.1 time:9953s

- 3) Press Menu key  to start feeding of screw No.1( This function is just the manual discharge function ) .

- 4) Press Setting key , it enters screw 1 50 secs. output testing screen

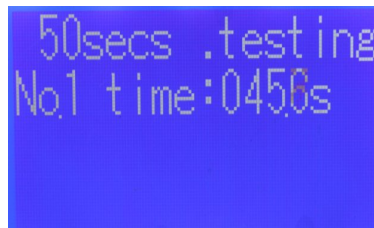

50secs .testing  
No.1 time:0456s

- 5) Press Menu key  to test screw 1 50 secs. output weight. After 50 secs., it enters screw 1 50 secs. weight input screen. Input the masterbatch weight output by screw in 50 secs. into corresponding place. The default is 50.



H1 50s weight  
Range :01-9999g  
Before:0500  
After :050

- 6) Press Menu key , save the setting and exit.



Note: For double shooter, the 50 secs. output setting of screw 2 is same as screw 1.

## 2. IMM Melting Time Setting

- 1) Press Menu key  till it displays melting time setting screen as below:

Melting time  
Range :01-9999s  
Before:0100  
After :0100

dddd



- 2) Press setting key  to shift the digital. Adjust the number by  and  key. Set melting time, its default is 10 secs.

- 3) Press Menu key , save the setting and exit.

## 3. Masterbatch Proportion Setting

- 1) Press Menu key  till it displays screw 1 and 2 proportion setting screen

Hopper1 ratio Range :001-9999% Before:2500 After :2500	Hopper2 ratio Range :001-9999% Before:2500 After :2500
---	---

- 3) Press setting key  to shift the digital, and adjust the number by  and  keys. Set proportion of screw 1 and 2. Setting proportion of screw 1 is 2%. When it uses two ingredients, the proportion of screw 2 is set as 3%.

- 4) Press Menu key , save the setting and exit.

## 4. Weight per Mould Setting

- Press the menu key  to select the weight interface of each mold as below.

According to the actual weight input of the IMM, the default value is 100g.

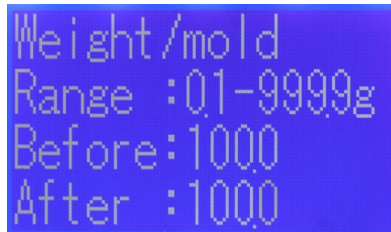

Weight/mold  
Range :01-9999g  
Before:1000  
After :1000

After above settings, turn on the main switch . The machine will feed the masterbatch and additives in time according to IMM's melting signal.

**Note: In this step, the input weight unit is consistent with that of the 50S measured value. For example, if the input unit is g (10g, 100g, kg...) in 50S test, then the input unit is g (10g, 100g, kg...).**

#### 4.3.2 Extruder Mode

According to the circuit diagram, when the extruder is in working mode (receive extruder signal 0 ~ 10V), the machine is in extruder working mode after powering on.

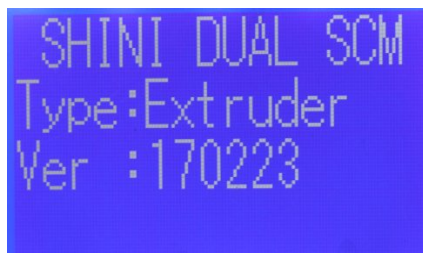

SHINI DUAL SCM  
Type:Extruder  
Ver :170223

##### 4.3.2.1 Parameters Set for Extruder Mode

1. 50 secs. weight setting steps:

Setting steps are the same as IMM

2. Masterbatch proportion setting

Setting steps are the same as IMM

3. Extruder max. output setting:

- 1) Press Menu key  till it displays extruder max. output setting screen as below:

```
Ext.max.output  
Range :01-999.9kg  
Before:0500  
After :0500
```

Set hourly max. output during extruder operation. The default is 50Kg/H.

2) Press menu key , save the setting and exit.

After above settings, turn on the main switch . The machine will feed the masterbatch and additives proportionally according to extruder signal (0~10V).

#### 4.3.3 Other Function Setting

##### 1. Micro-metering Method (only for IMM).

Function: When each mould only requires a few masterbatches (less than 0.5g), it can use this function. Set discharge cycle as 2, which means once master discharge in twice IMM signals, and so on.

Setting steps: After setting the 50 secs. output value, masterbatch proportion, weight per mould and melting time according to IMM mode, press Menu key



till it displays discharge cycle screen as below. Change the discharge cycle, then the setting is finished. The default is 1.

```
Dis.cycle  
Range :1-10  
Before:01  
After :01
```

##### 2. Color Compensation Mode

Function: When screw 2 feeds regrind, it can add the masterbatch in proportion only to the regrinds. Total masterbatch that the screw fed equals to original required amount plus regrind required amount. The default is 0.

```
H2 clr.com.ratio
Range :0-9999%
Before:1000
After :1000
```

### 3. Screw 2 Optional Level Switch Mode

Function: When hopper of screw 2 options with level switch that detects the low level during operation, screw 2 will stop metering. Insufficient regrinds will be fed by basterbatch and material proportionally and automatically.

#### 4.3.4 Other Parameters Function

##### 1. Control type (0~3 for selection for IMM mode, the default is 0):

0--- External signal & setting time

1--- External signal: when Doser works, the signal is determined by external signal.

2--- Melting time: When Doser works the signal is determined by set signal of melting time.

3---External signal: When Doser works, the signal is determined by previous mould received signal of melting time.

When the setting is 0, it means feeding time of Doser screw is determined either by external signal or set melting time, depending on whose lasting time is shorter. Such as: When IMM motion signal ended but Doser set melting time still on, Doser screw will stop feeding. When IMM motion signal lasts but Doser set melting time is over, Doser screw will stop feeding too.

When the setting is 1, Doser screw won't stop feeding unless external signal breaks.

When the setting is 2, Doser screw stops feeding when melting time is over.

When the setting is 3, it drives the screw according to previous mould received melting time.

```
Control type
Range :0-3
Before:0
After :0
```

2. Motor rotation direction setting:

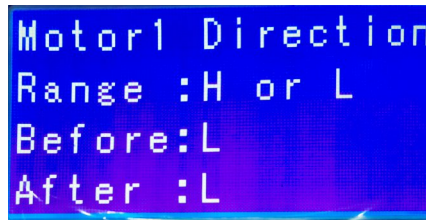



Notes:

L: Motor rotates clockwise

H: Motor rotates anti-clockwise

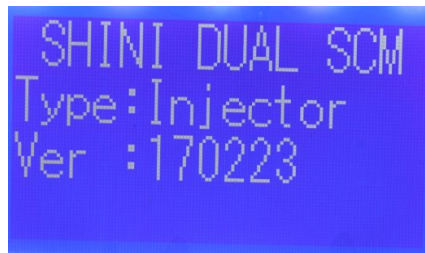
3. Setting for Communication with Upper Unit



After it enters above start screen, hold on  and  together for 3 secs.

It enters parameter setting for communication.

When communicating with upper unit, the machine should set parameters as below:

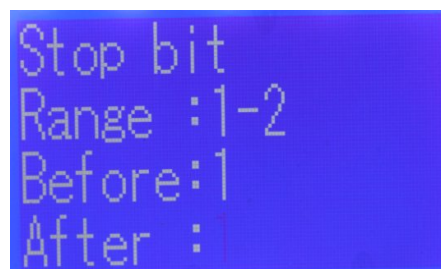
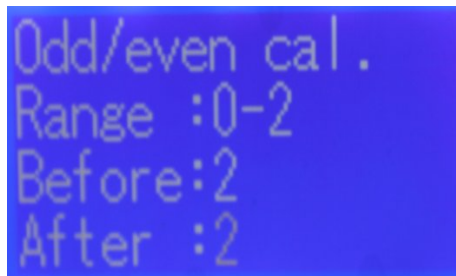
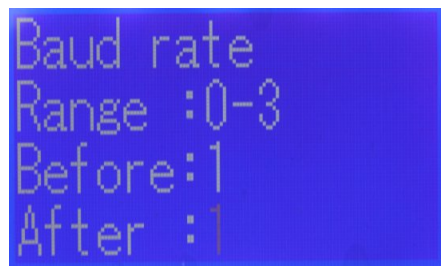
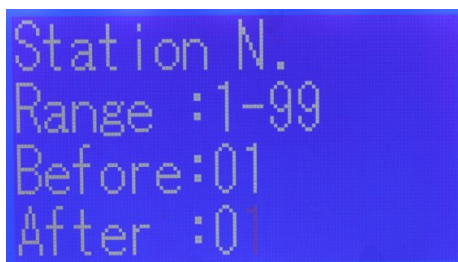

F26: Station No.	1~99
F27: Baud Rate	0: 4800 1: 9600 2: 19200 3: 38400
F28: Odd-even Check	0: No 1: Even 2: Odd
F29: Stop Bit	1: 1bit 2: 2bit

#### 4. Metering Motor Output

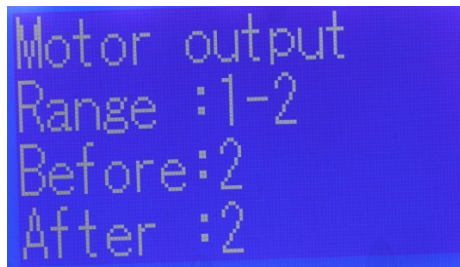

```
Motor output
Range :1-2
Before:2
After :2
```

Note: For single ingredient, the metering motor outputs 1; For double ingredients, the metering motor outputs 2.



## 4.4 Replace Dosing Screws

- 1) Cut off power supply, loosen snap hook of the hopper, draw out the hopper and screw. Then, unlock the screw fastening plate to remove the conveying screw for replacement. During screw replacement, it should replace the sleeve simultaneously (different screw diameters are matching different sleeves).
- 2) Install the screw and hopper back to the machine.

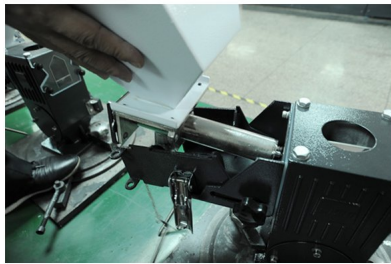

1



2



3

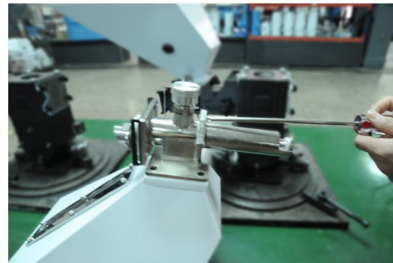

4

Picture 4-2: Replace Dosing Screws

## 5. Trouble Shooting

Failures	Possible reasons	Solutions
No indicates on the control cabinet.	1. Power supply not connected.	1. Connect the power supply.
	2. Fuse burnt out or control board problems	2. Replace the fuse or check control board.
Motor does not work.	1. Parameter mistakes.	1. Reset parameters.
	2. Motor overload.	2. Contact the manufacturer or local distributor.
	3. Motor damaged.	3. Replace the motor.
	4. Signal wire broken.	4. Replace motor signal wire.
	5. Signal wire connection wrong	5. Conduct Inspection
The buzzer sounds the alarm.	Parameter setting exceeds the limit.	Reset parameters.

## 6. Maintenance and Repair

### 6.1 Repair

All the repair work should be done by qualified technicians to prevent personal injuries and damage of the machine.

### 6.2 Maintenance

Keep the surface of machine clean.

### 6.3 Maintenance Schedule

#### 6.3.1 About the Machine

Model \_\_\_\_\_ No. \_\_\_\_\_ Manufacturing date : \_\_\_\_\_

Voltage \_\_\_\_\_  $\Phi$  \_\_\_\_\_ V Frequency \_\_\_\_\_ Hz Total power: \_\_\_\_\_ kW

#### 6.3.2 Check after Installation

- Check that dosing screws are fitted correctly.
- Check the snap hook is tightly locked.
- Check if the mounting base is firmly locked.

#### Electrical Installation

- Voltage: \_\_\_\_\_ V \_\_\_\_\_ Hz
- Fuse melt current: 1 Phase \_\_\_\_\_ A 3 Phase \_\_\_\_\_ A
- Power supply and signal wire of control cabinet are correctly connected.

#### 6.3.3 Daily Checking

- Check the main switch.
- Check fastening screws of mounting base.

#### 6.3.4 Weekly Checking

- Check if there damaged electrical wires.
- Check snap hooks are loose or not.
- Check if the side holding plate is loose or not.